

编译者说明

由于电子工业和电影、电视事业的飞速发展，近年来我国在光学镜头设计及其加工方面取得了很大进展。成系列的各类镜头已经设计和试制出来，有些并已进入成批生产阶段。但在品种、数量和质量方面，跟世界先进水平相比，差距还是比较大。

近年来，我们收集了美、英、德、日等国从 1811 年到现在的光学镜头资料及部分国内镜头资料共 3000 多种，现挑选其中的一部分经补充整理之后，将其出版，以供我国从事光学镜头设计的人员参考。

我们准备分成“大相对孔径物镜”（第一、二册，已出），“广角物镜”（第三册，已出），“变焦距物镜”（第四册，已出），“中等视场中等孔径物镜”（第五册，已出），“日本七十年代初的部分大相对孔径物镜及部分广角物镜专集”（第六册，已出），“1978~1980 年国外部分物镜专集”（第七册），“目镜和显微物镜”（第八册），“非球面系统”（第九册），“特种镜头及其他”（第十册）等九类。每册收集的镜头数约为 100~200 个。

原资料中，大部分没有列出象差曲线图，我们均重新计算给予补上。由于原资料的光阑位置大多没有给出，我们计算时只能根据我们主观给定的光阑位置进行计算，因此相应的象差曲线图仅供参考。

本册的内容为 1978~1980 年国外部分物镜专集。

由于我们水平有限，时间仓促，力量不足，所以只能一部分一部分地整理出版，而且在整理过程中，一定存在不少缺点和错误，分类也不可能完全合理，望读者批评指正。

参加本册编译工作的有杨庭田和林茂智同志，春光、林金明等同志参加了部分工作。

编译者

目 录

符号说明	1
大孔径照相物镜	2
大孔径远摄物镜	3
大孔径远摄物镜	4
反远距物镜	5
反远距物镜	6
大孔径照相物镜	7
小型远摄物镜	8
高斯型放大制版物镜	9
高斯型放大制版物镜	10
大孔径远摄物镜	11
远摄物镜	12
照相物镜	13
照相物镜	14
广角照相物镜	15
反远距型广角物镜	16
超广角大孔径物镜	17
超广角大孔径物镜	18
广角物镜	19
广角物镜	20
广角物镜	21
体积小的反远距型广角物镜	22
体积小的反远距型广角物镜	23
准广角大孔径物镜	24
准广角大孔径物镜	25
准广角大孔径物镜	26
五片式反远距型广角物镜	27
五片式反远距型广角物镜	28
广角物镜	29
广角物镜	30
广角照相物镜	31
广角照相物镜	32
反远距型超广角照相物镜	33

广角物镜	34
超广角大孔径物镜	35
超广角大孔径物镜	36
反远距型广角大孔径物镜	37
反远距型广角大孔径物镜	38
广角照相物镜	39
反远距型广角物镜	40
反远距型广角物镜	41
反远距型广角物镜	42
反远距型广角物镜	43
体积小重量轻的反远距型广角物镜	44
体积小重量轻的反远距型广角物镜	45
反远距型广角物镜	46
反远距型广角物镜	47
反远距型广角物镜	48
反远距型超广角物镜	49
反远距型超广角物镜	50
反远距型超广角物镜	51
反远距型超广角物镜	52
反远距型广角照相物镜	53
反远距型广角照相物镜	54
超广角大孔径照相物镜	55
超广角大孔径照相物镜	56
超广角物镜	57
反远距型广角物镜	58
超广角大孔径照相物镜	59
超广角大孔径照相物镜	60
超广角大孔径照相物镜	61
超广角大孔径照相物镜	62
反远距型超广角物镜	63
广角照相物镜	64
广角照相物镜	65
鱼眼物镜	66
鱼眼物镜	67
变焦距物镜	68
高变倍率等效变焦距物镜	72
超高变倍率变焦距物镜	78
大孔径高变倍率变焦距物镜	79

大孔径高变倍率变焦距物镜·····	80
明亮的投影物镜·····	81
明亮的投影物镜·····	82
投影物镜·····	83
高倍率投影物镜·····	84
超高倍率投影物镜·····	85
远摄物镜·····	86
远摄物镜·····	87
消色差物镜·····	88
消色差物镜·····	89
消色差物镜·····	90
消色差物镜·····	91
长焦距折反射式物镜·····	92
摄影机用摄影镜头·····	93
超远摄物镜·····	94
小型远摄物镜·····	95
小型远摄物镜·····	96
短的远摄物镜·····	97
短的远摄物镜·····	98
高斯型物镜·····	99
高斯型放大制版物镜·····	100
高斯型放大制版物镜·····	101
精缩镜头·····	102

符号说明

1. 凡数据后有符号“*”，表示光栏位置或其值中间有光栏。
凡数据后有符号“**”，表示原资料中未给此值，此系编者在计算时给定的值。
2. 本册各镜头的数据，均以毫米为单位。

3. 常用符号：

ΣS_1	球差系数和；
ΣS_2	彗差系数和；
ΣS_3	象散系数和；
ΣS_4	场曲系数和；
ΣS_5	畸变系数和；
LA'	球差；
$\Delta H'$	绝对畸变；
x'_i	细光束子午场曲；
x'_s	细光束弧矢场曲；
$x'_i - x'_s$	象散；
K'_{F1}	全口径的子午彗差；
$K'_{F0.7}$	0.707 口径的子午彗差；
QP	相对畸变；
HI	理想象高；
E. F. L	焦距；
B. F. L	后截距；
FNo.	相对孔径倒数；
F. A.	视场角；
L'_p	入瞳距离或光栏距 L'_p 下标所示面的距离；
η	物高；
ω	镜头视场。

编号: 07-00-001

大孔径照相物镜

E. F. L = 100

B. F. L = 74.2

FNo. = 1.2

F. A. = $\pm 23^\circ$

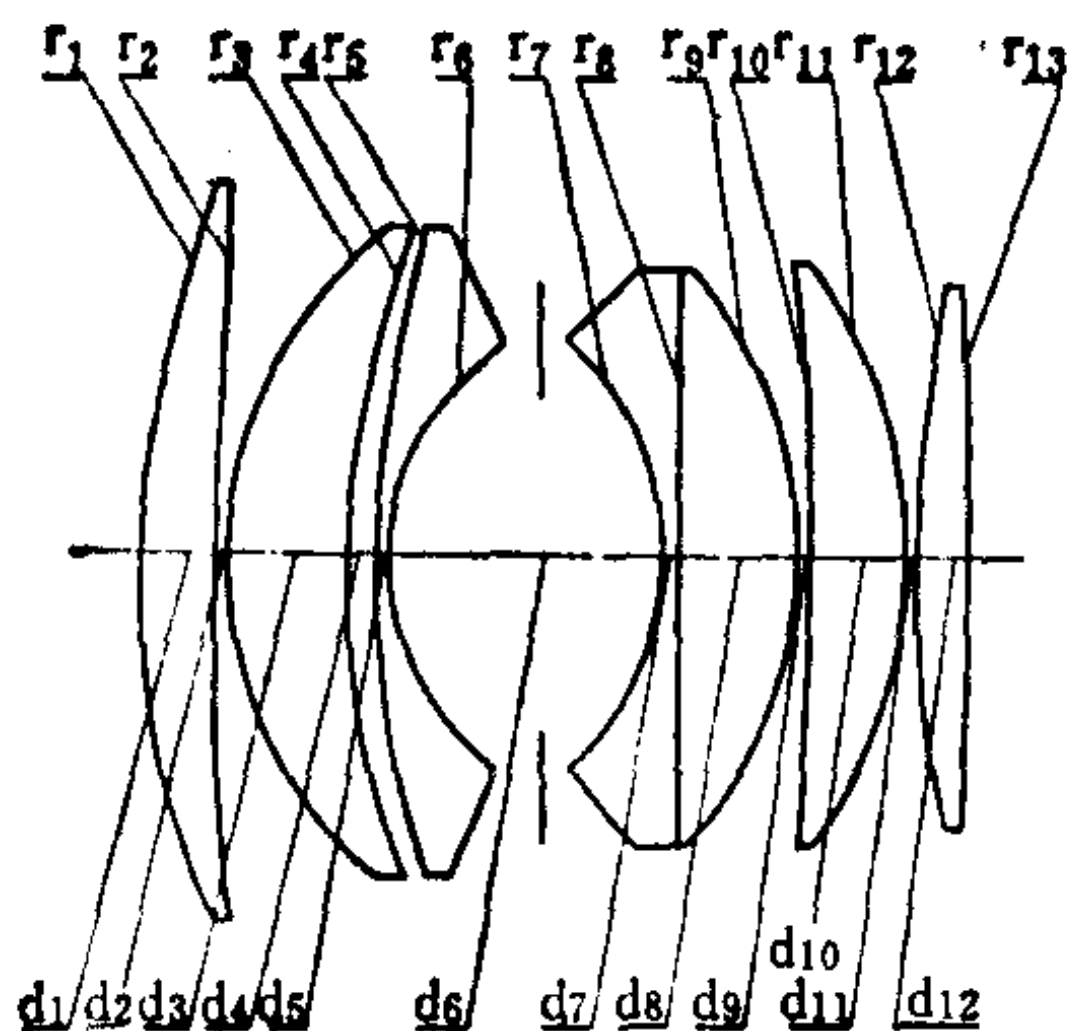

序号	r	d	nd	vd	序号	r	d	nd	vd
1	125.969	10.85	1.79631	40.8	8	∞	16.67	1.77279	49.5
2	968.992	0.19			9	-57.171	0.19		
3	56.202	15.50	1.76684	46.6	10	-237.500	11.82	1.71300	53.9
4	115.310	2.91			11	-67.054	0.19		
5	155.039	2.91	1.68893	31.1	12	176.357	6.40	1.76684	46.6
6	35.754	34.50*			13	-416.759			
7	-35.601	2.13	1.75520	27.5					

34.50* = 17.25 + 17.25

	ΣS_1	ΣS_2	ΣS_3	ΣS_4	ΣS_5	HI	QP (1 ω)
	-0.3860	0.0232	0.0883	-0.4609	-0.7805	42.4	-2%
h 或 ω %	LA'	$\Delta H'$	x_t'	x_s'	$x_t' - x_s'$	K'_{T1}	$K'_{T0.7}$
100	-0.214	-0.875	-0.852	-0.116	-0.736	0.2393	-0.2012
70	-0.225	-0.352	-0.283	-0.337	0.054	0.2777	-0.0355

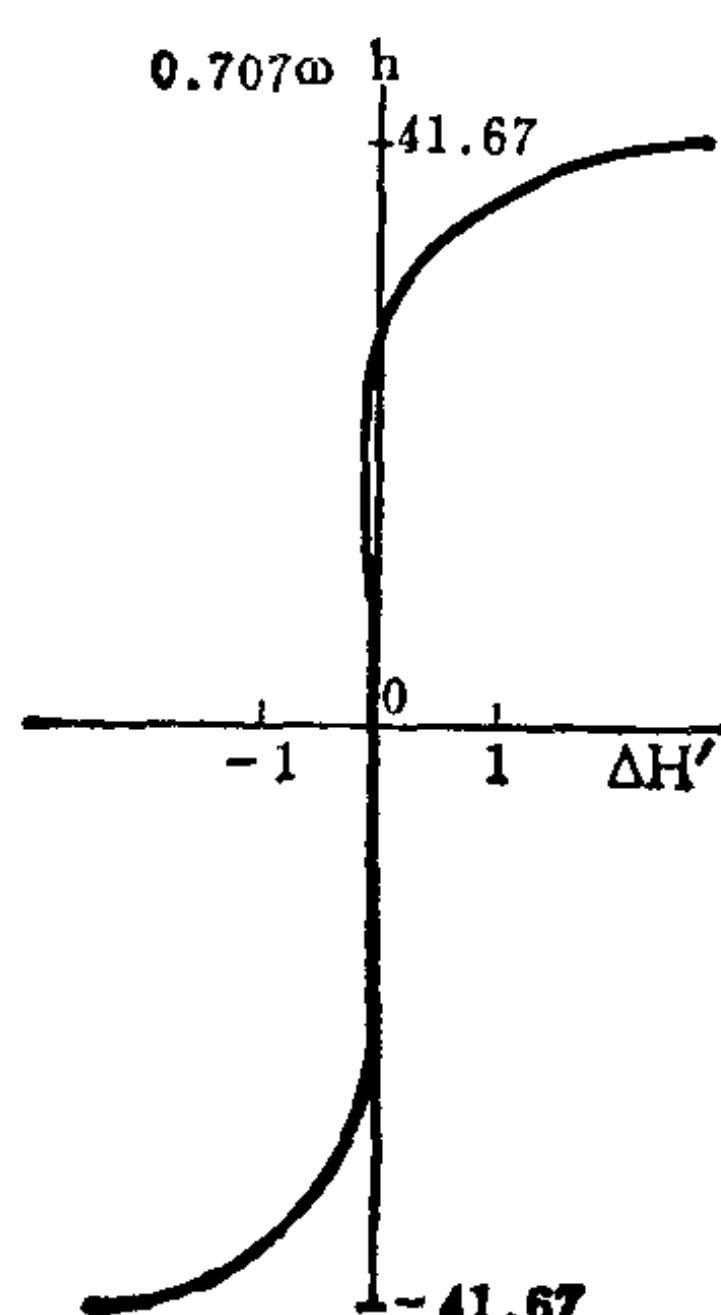
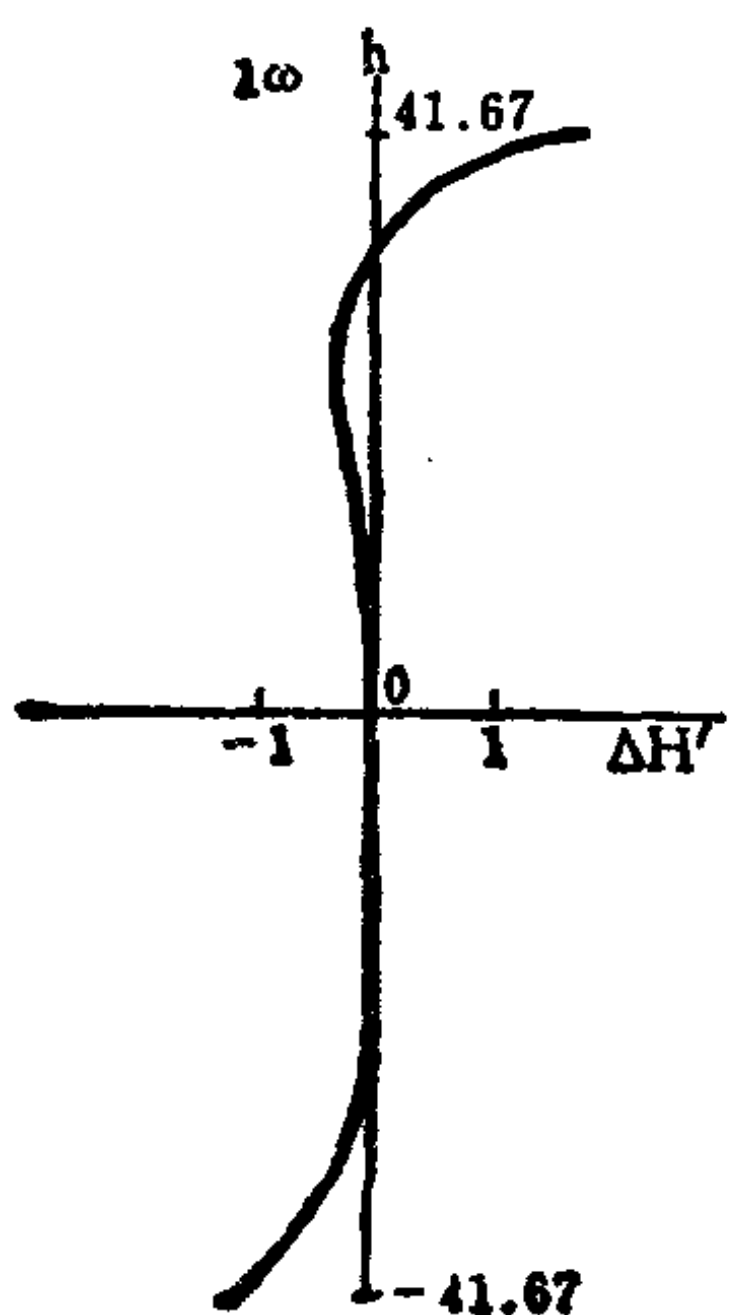
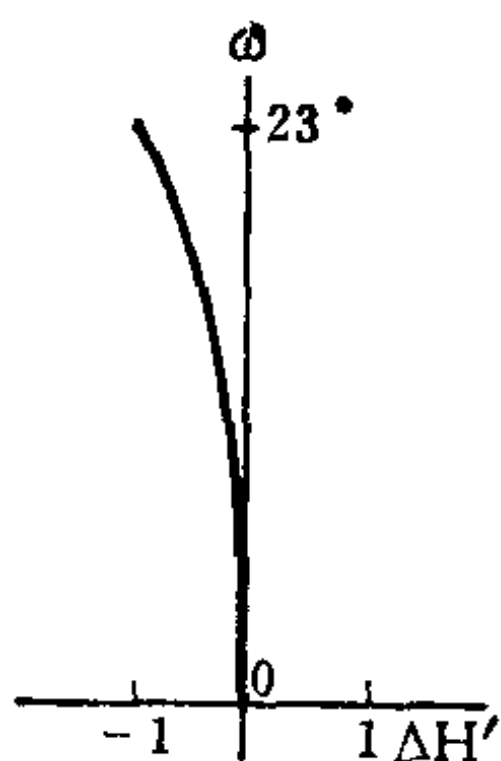
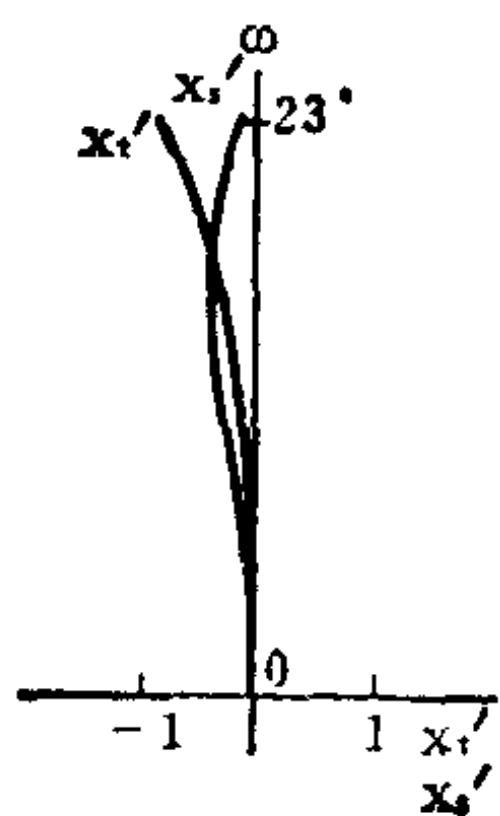
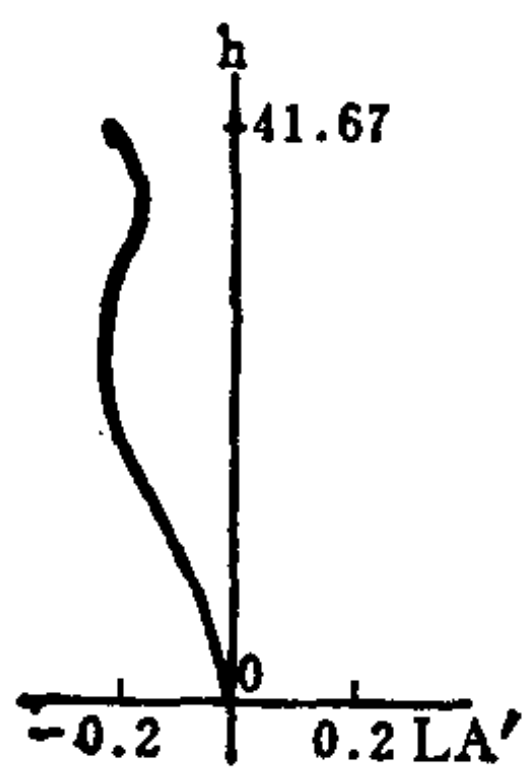

编号: 07-00-002

大孔径远摄物镜

E. F. L = 100

B. F. L = 39.9

FNo. = 2

F. A. = ±12°

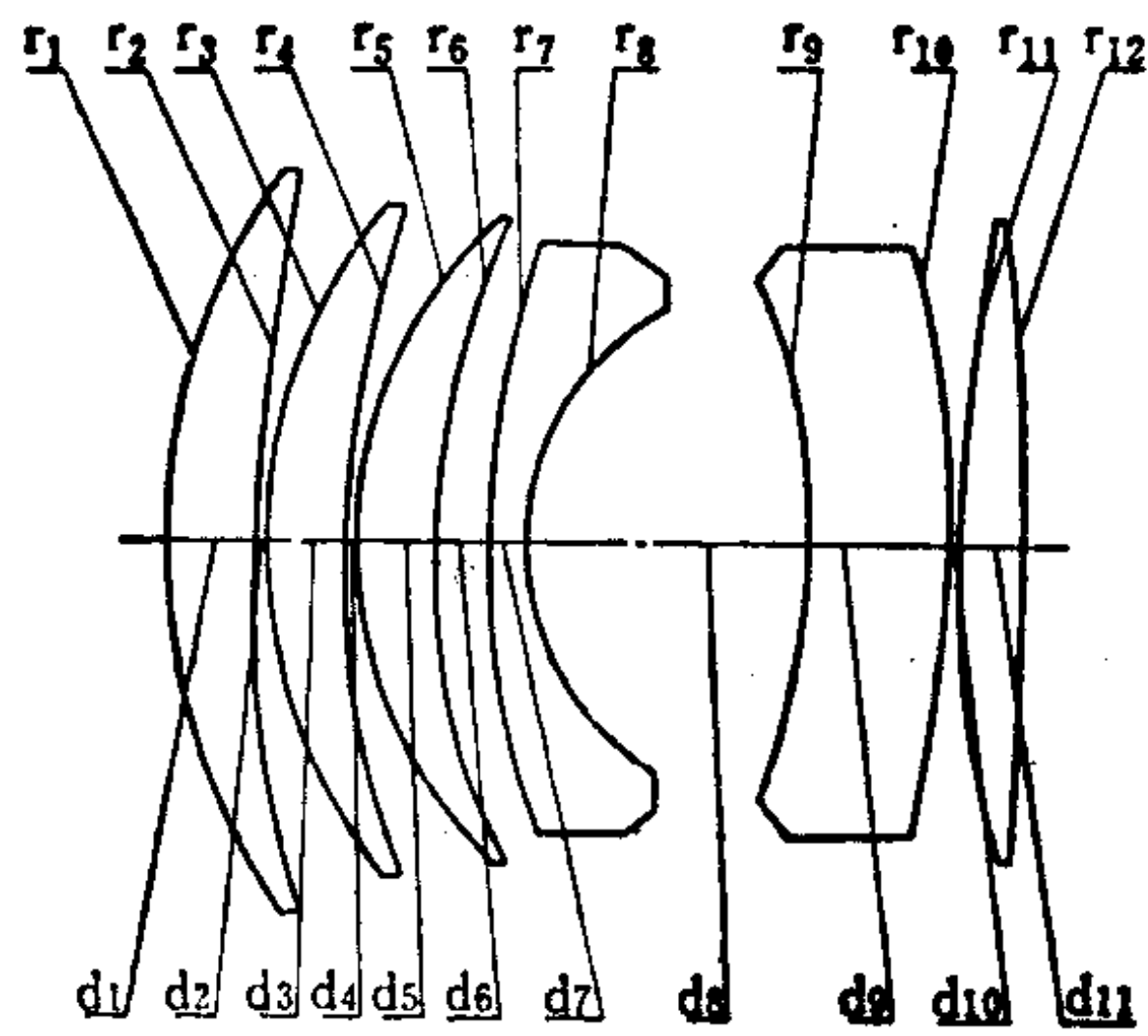

序号	r	d	n	v	序号	r	d	n	v
1	41.623	7.00	1.62041	60.27	7	70.094	2.20	1.78472	25.71
2	119.125	0.16			8	18.224	20.00*		
3	36.340	5.50	1.62230	53.20	9	-44.400	9.49	1.64769	33.80
4	68.521	0.16			10	-74.931	0.20		
5	30.050	5.00	1.62041	60.27	11	100.258	3.51	1.75520	27.51
6	49.039	3.78			12	-216.912			

20.00* = 10.00 + 10.00

	ΣS_1	ΣS_2	ΣS_3	ΣS_4	ΣS_5	HI	QP(1 ω)
	-0.0469	-0.0091	-0.0087	-0.0185	0.1913	21.2	1.5%
h 或 ω %	LA'	$\Delta H'$	x'_t	x'_s	$x'_t - x'_s$	K'_{T1}	$K'_{T0.7}$
100	-0.0240	0.333	0.0525	-0.0233	0.0758	0.2090	0.0379
70	-0.0807	0.129	-0.0829	-0.0660	-0.0169	0.1306	0.0125

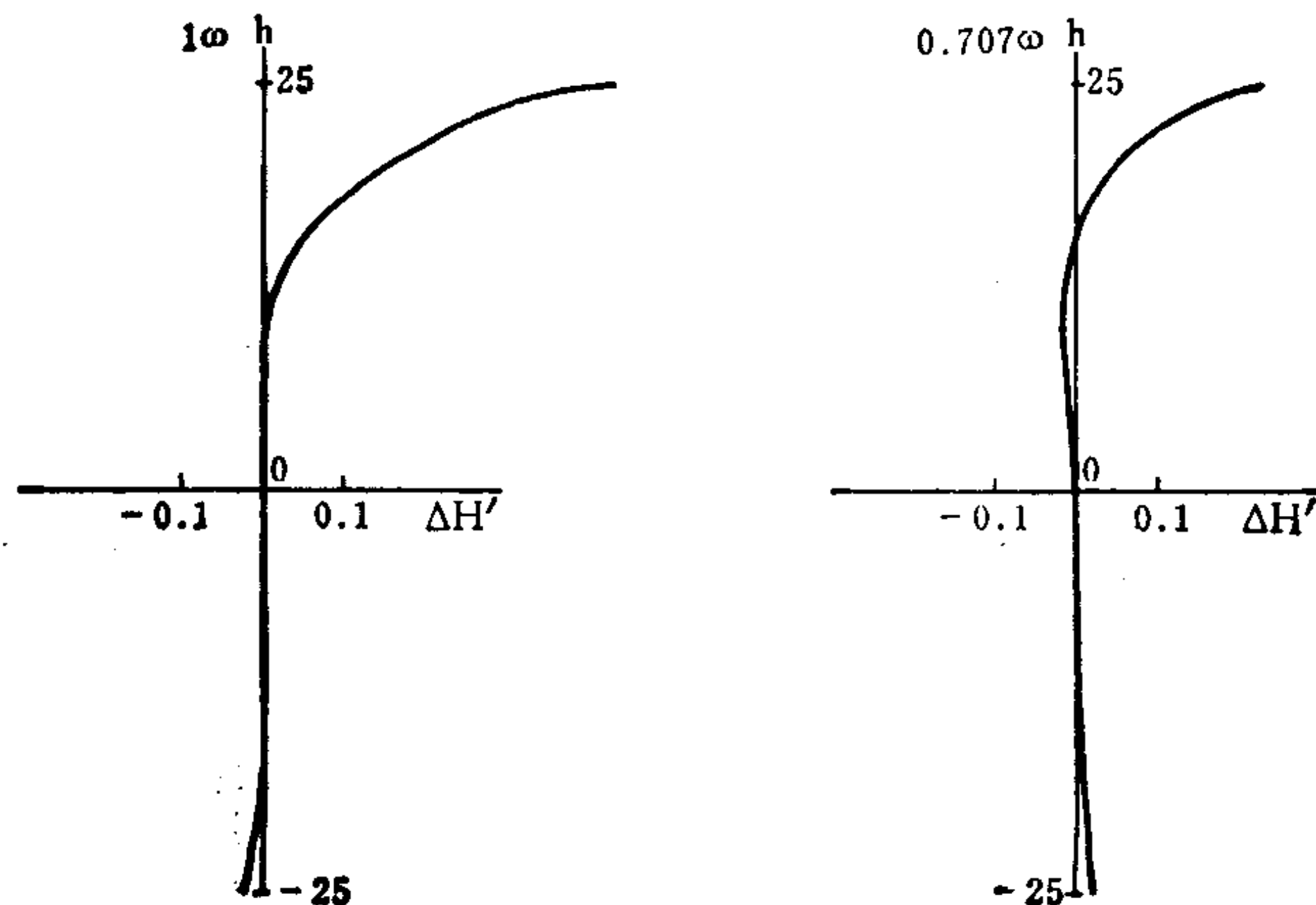
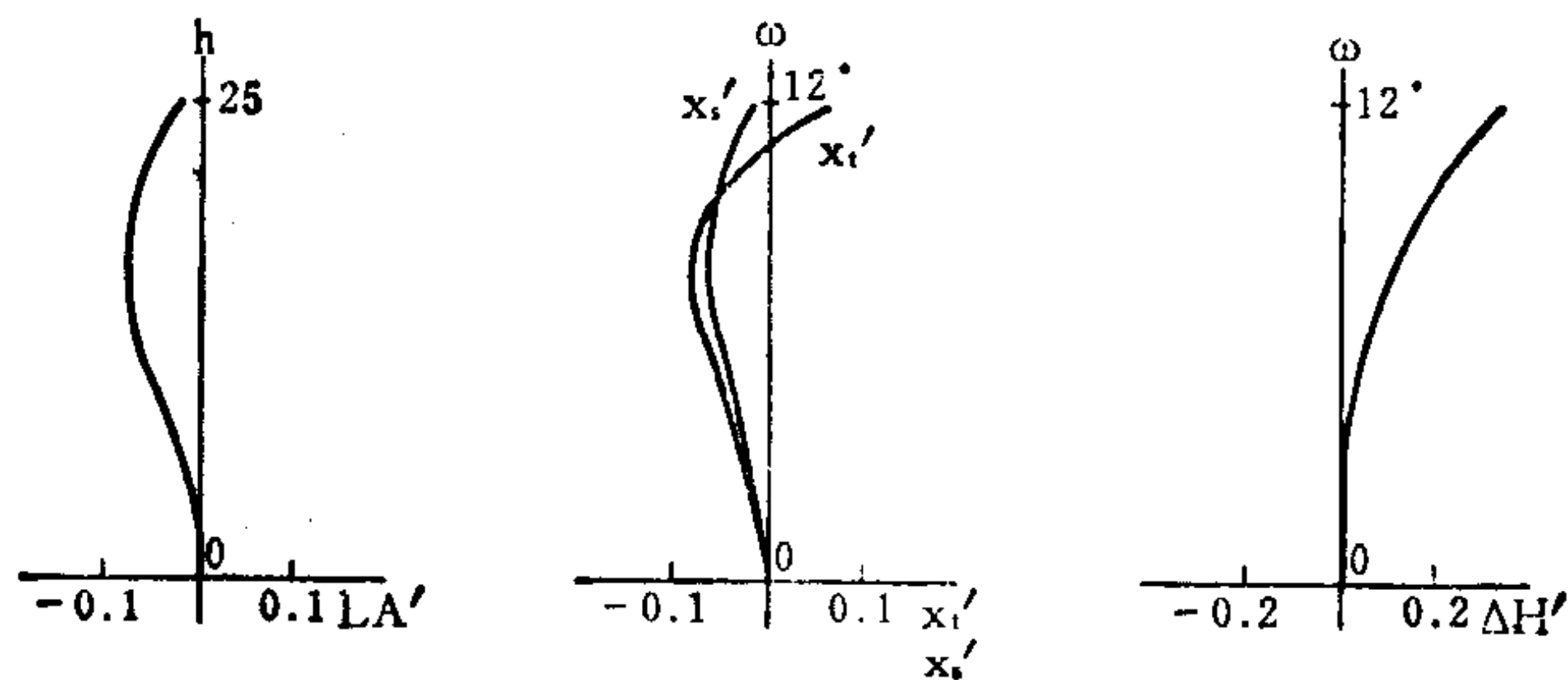

编号: 07-00-003

大孔径远摄物镜

E. F. L = 100

B. F. L = 40.6

FNo. = 2

F. A. = ± 12°

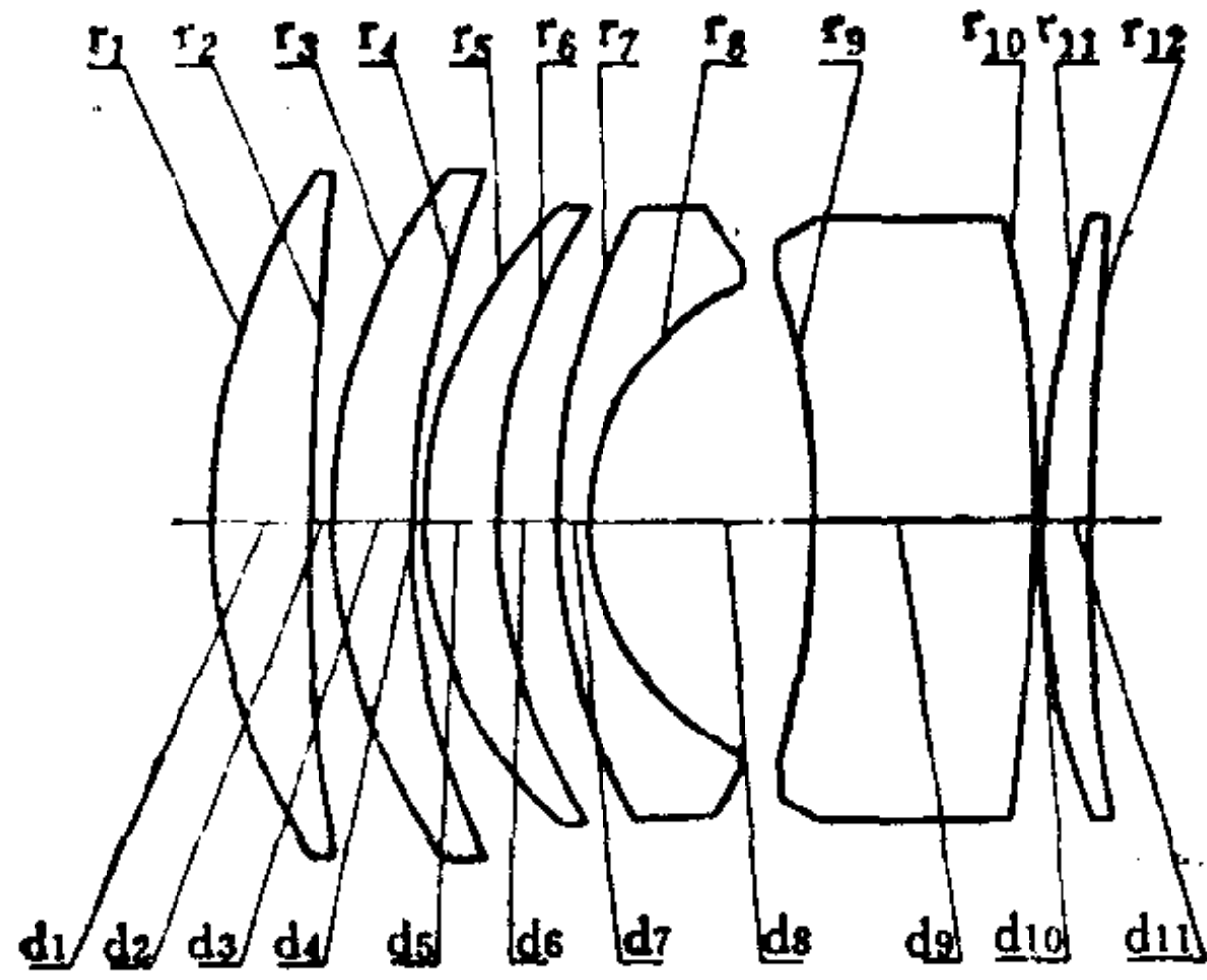

序号	r	d	n	v	序号	r	d	n	v
1	43.669	7.00	1.61800	64.51	7	43.640	2.20	1.78472	25.71
2	148.833	0.16			8	17.212	15.00*		
3	37.683	5.50	1.62041	60.27	9	-56.712	14.50	1.64769	33.80
4	56.374	0.16			10	-125.053	0.20		
5	25.842	5.00	1.62041	60.27	11	75.814	3.50	1.75520	27.51
6	37.998	3.78			12	1352.567			

15.00* = 7.50 + 7.50

	ΣS_1	ΣS_2	ΣS_3	ΣS_4	ΣS_5	HI	QP (1 ω)
	-0.0493	-0.0430	-0.0043	-0.0104	0.1816	21.2	1.5%
h 或 ω %	LA'	$\Delta H'$	x'_t	x'_s	$x'_t - x'_s$	K'_{T1}	$K'_{T0.7}$
100	-0.0483	0.318	-0.2080	0.0016	-0.2096	0.5525	0.1227
70	-0.0806	0.123	-0.1037	-0.0355	-0.0682	0.2616	0.0187

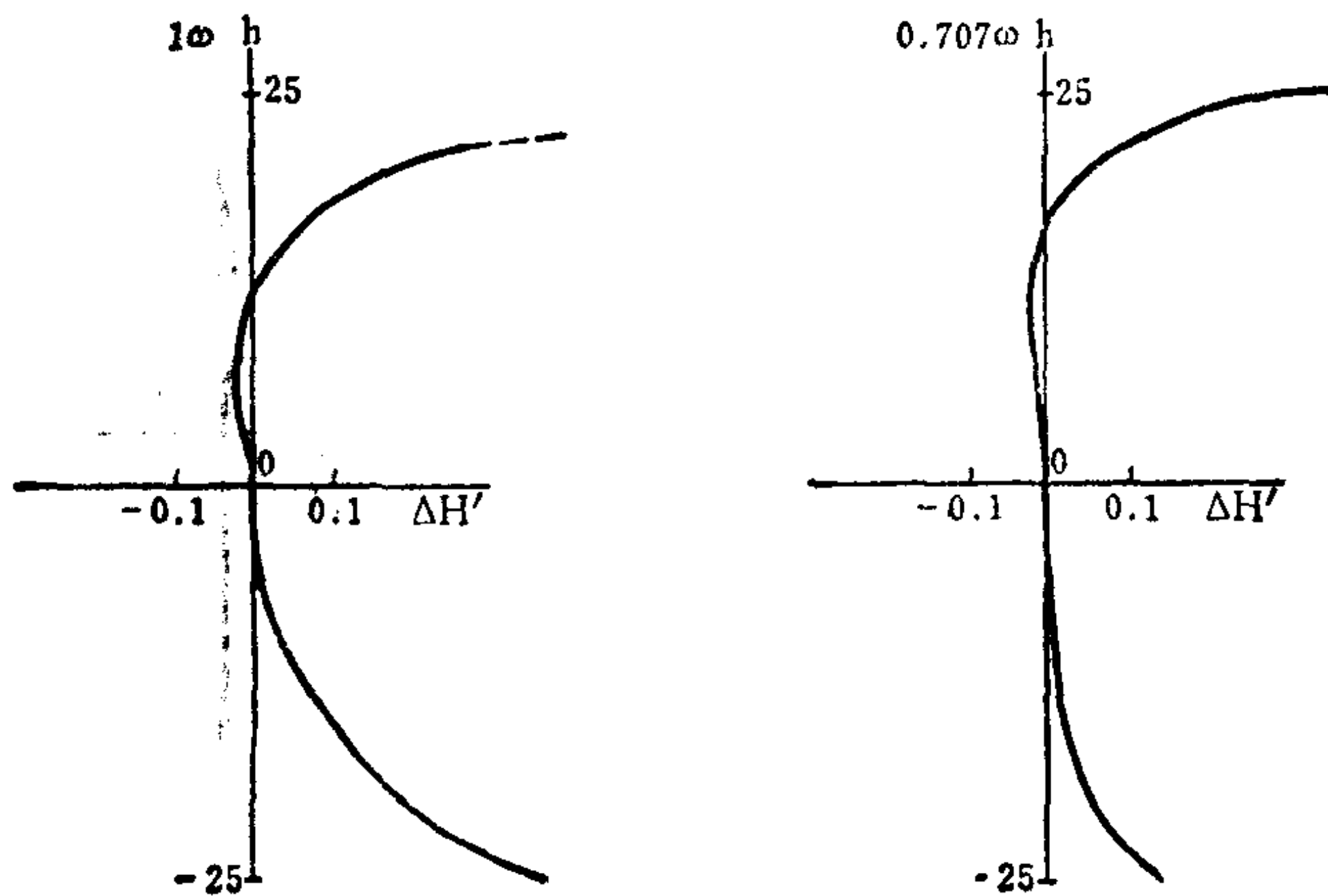
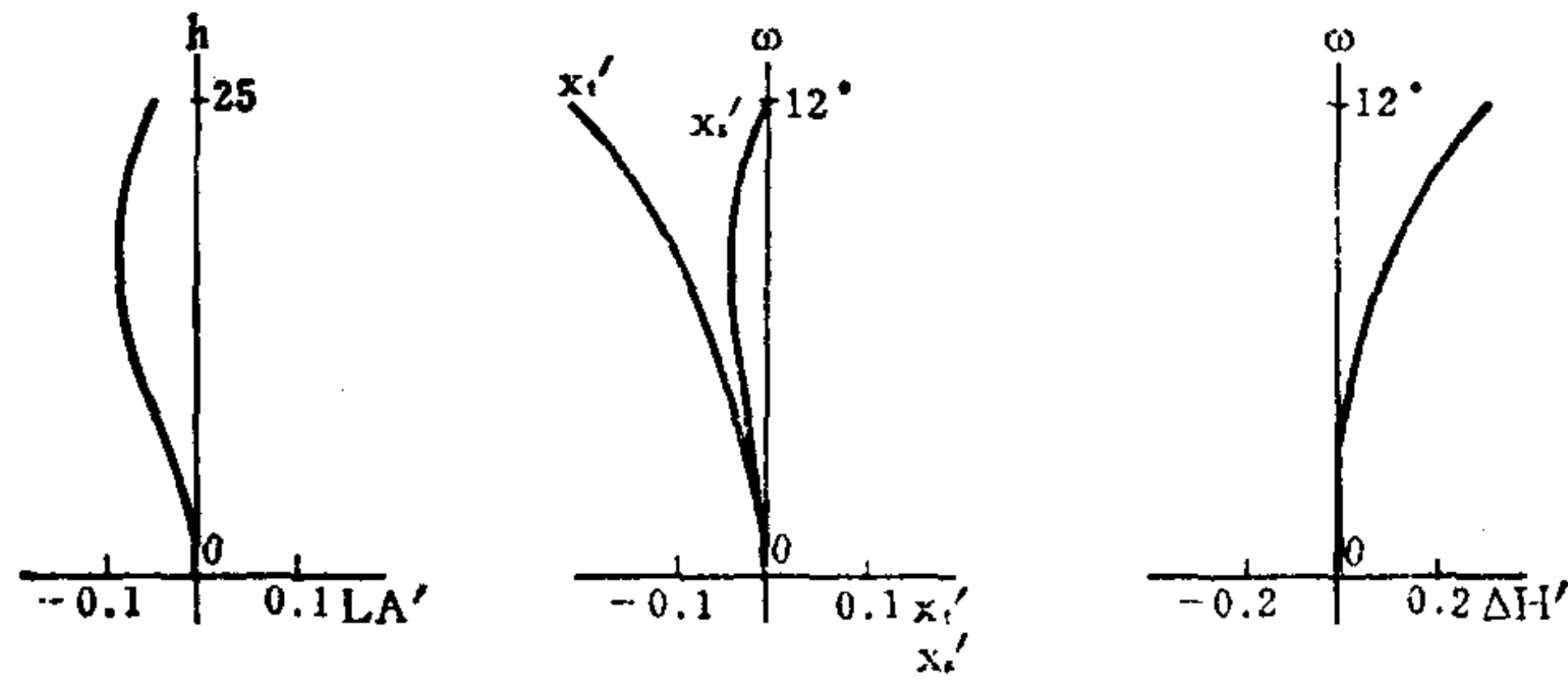

编号: 07-00-004

反 远 距 物 镜

E. F. L = 1

B. F. L = 0.84

FNo. = 1.6

F. A. = $\pm 28^\circ$

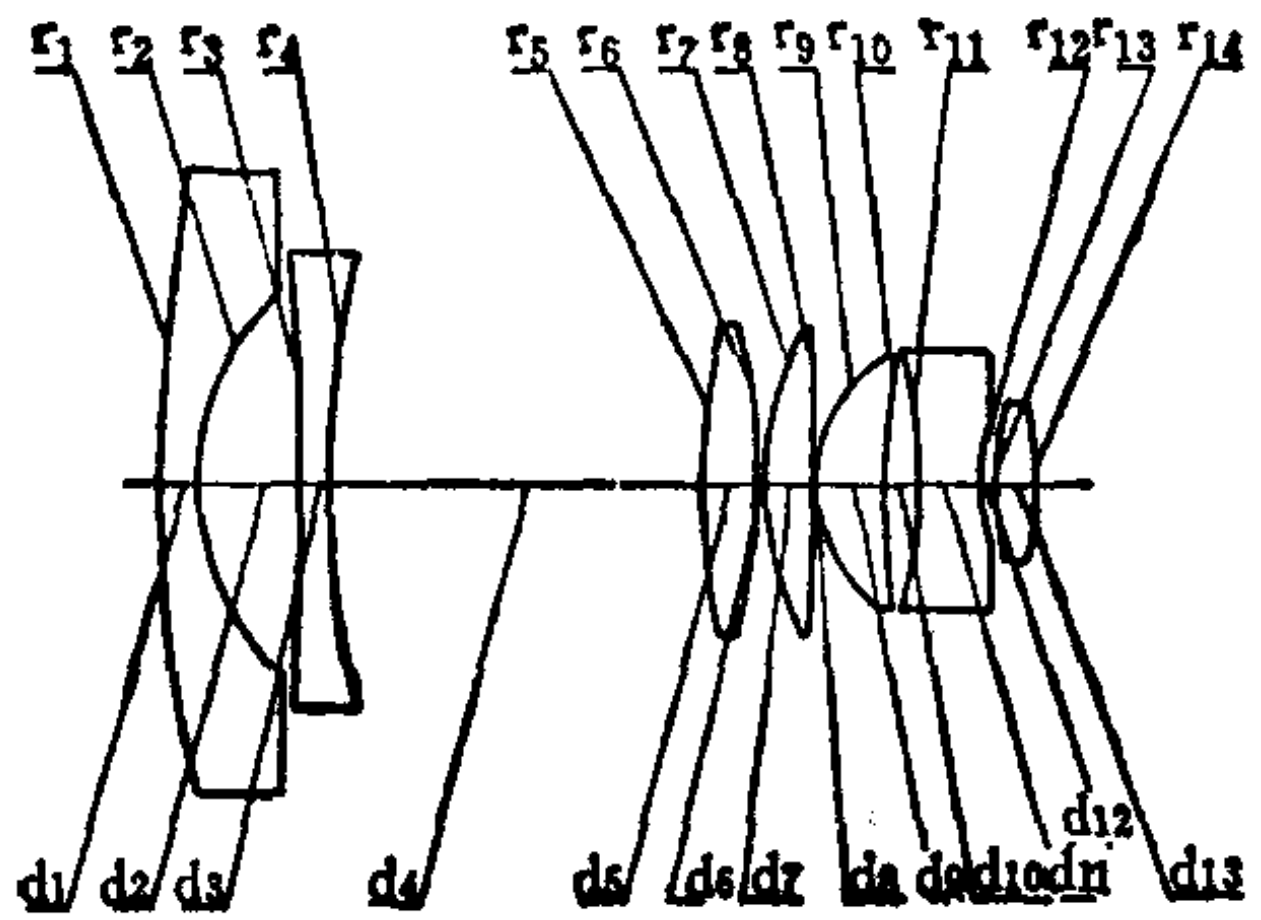

序号	r	d	n_d	v_d	序号	r	d	n_d	v_d
1	10.650	0.215	1.487	70.4	8	-24.784	0.015		
2	1.689	0.615			9	0.988	0.446	1.504	66.9
3	-20.951	0.169	1.518	65.1	10	13.517	0.108		
4	6.461	2.415			11	-4.626	0.431	1.785	26.1
5	4.541	0.323	1.518	65.1	12	0.668	0.154*		
6	-4.541	0.015			13	2.587	0.277	1.658	57.3
7	2.548	0.262	1.620	60.3	14	-1.093			

$0.154^* = 0.104 + 0.050$

	ΣS_1	ΣS_2	ΣS_3	ΣS_4	ΣS_5	HI	QP(1 ω)
	-0.00461	-0.00018	0.00046	-0.00347	-0.00168	0.53	-0.07%
h 或 ω %	LA'	$\Delta H'$	x'_t	x'_s	$x'_t - x'_s$	K'_{T1}	$K'_{T0.7}$
100	-0.00641	-0.00039	-0.0157	-0.0089	-0.0068	0.03	0.00563
70	-0.00878	-0.00078	-0.0039	-0.0066	0.0027	0.00303	0.00065

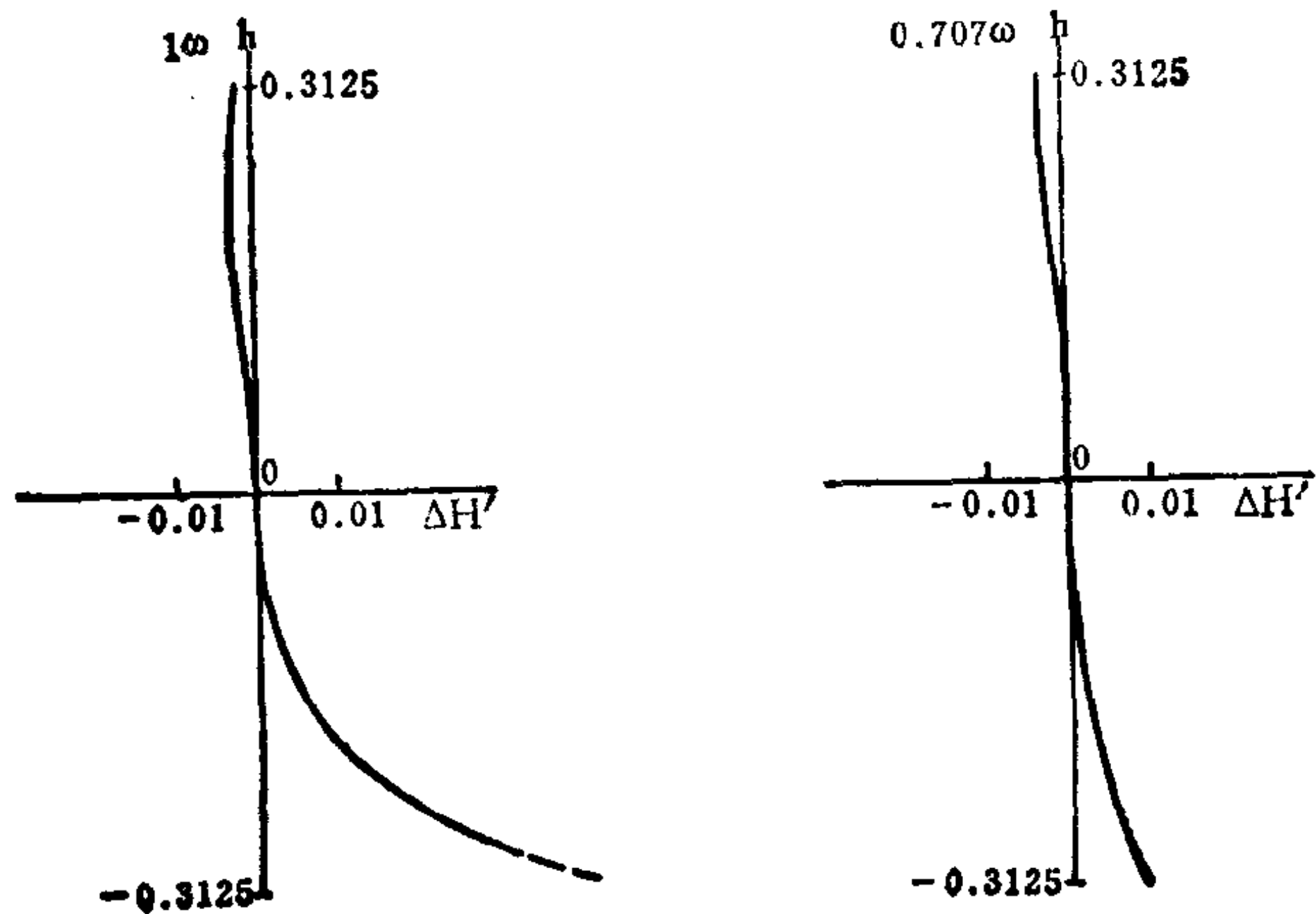
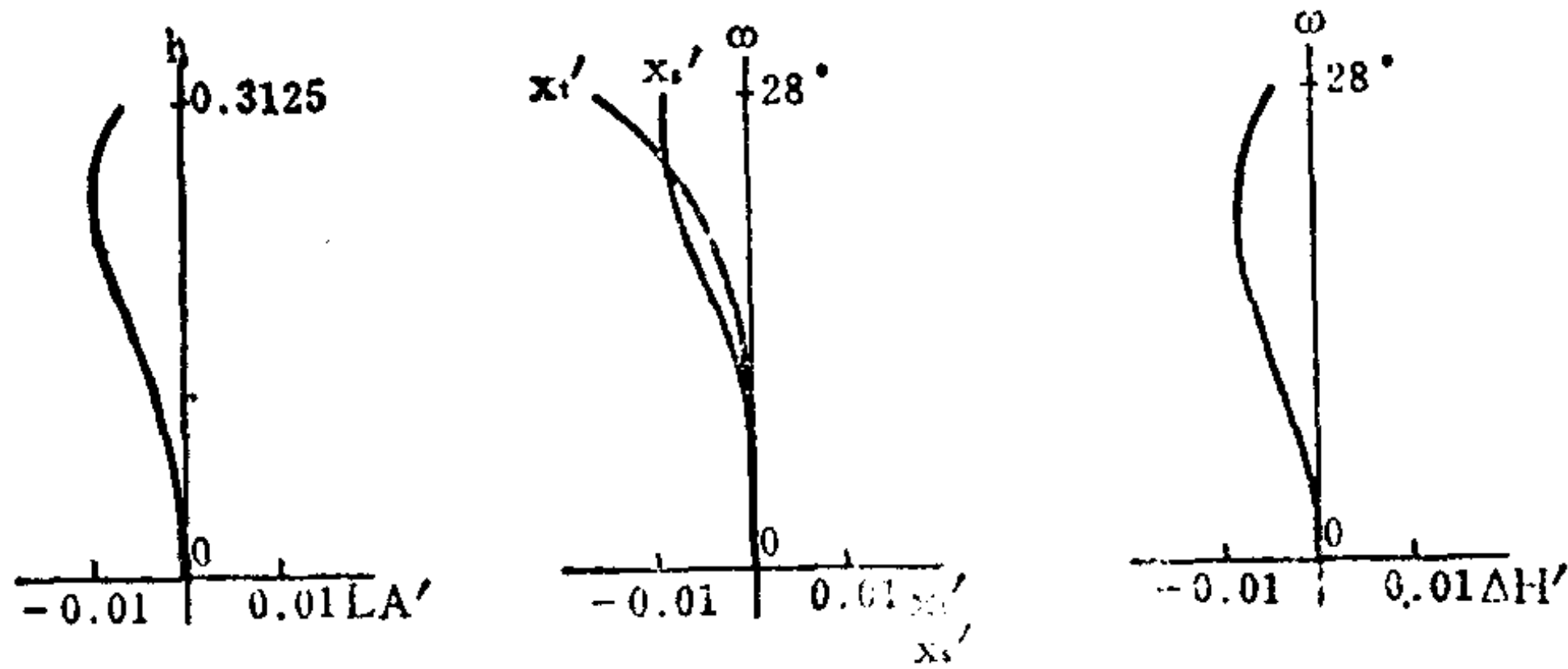

编号: 07-00-005

反 远 距 物 镜

E. F. L = 1

B. F. L = 0.75

FNo. = 1.6

F. A. = ± 28°

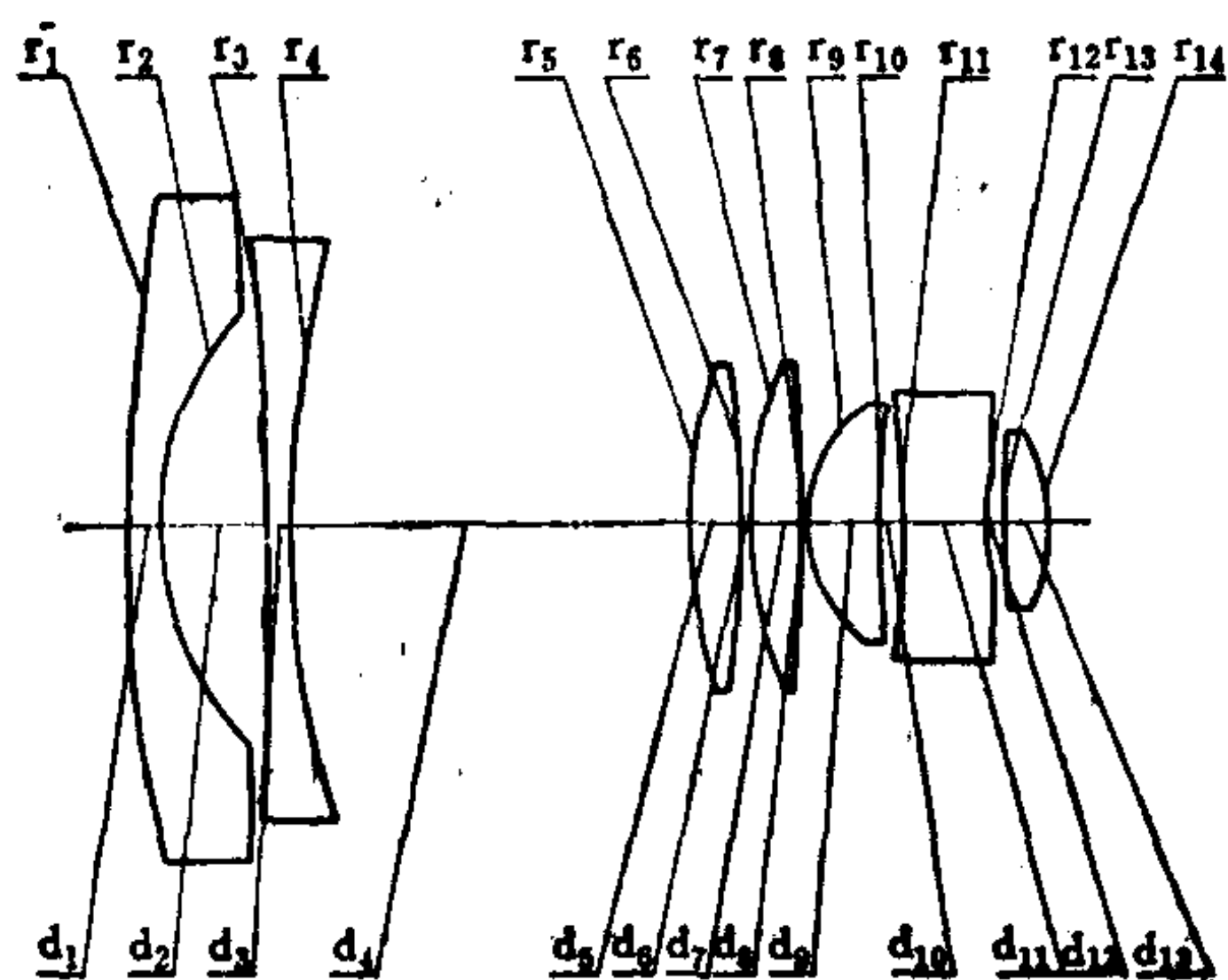

序号	r	d	na	va	序号	r	d	na	va
1	10.853	0.221	1.487	70.4	8	-31.964	0.014		
2	1.848	0.614			9	0.908	0.441	1.504	66.9
3	-14.482	0.166	1.518	65.1	10	11.682	0.110*		
4	6.463	2.414			11	-5.071	0.428	1.785	26.1
5	4.541	0.317	1.518	65.1	12	0.611	0.152		
6	-4.541	0.014			13	2.448	0.276	1.678	55.2
7	2.547	0.262	1.620	60.3	14	-1.115			

0.110* = 0.055 + 0.055

	ΣS_1	ΣS_2	ΣS_3	ΣS_4	ΣS_5	HI	QP (1 ω)
	-0.00441	-0.00356	-0.00207	-0.00324	-0.00094	0.53	1.4%
h 或 ω %	LA'	$\Delta H'$	x'_t	x'_s	$x'_t - x'_s$	K'_{T1}	$K'_{T0.7}$
100	-0.00450	0.0076	0.00349	-0.00274	0.00623	0.02763	0.00675
70	-0.00790	0.0012	-0.01184	-0.00813	-0.00371	0.00495	-0.00074

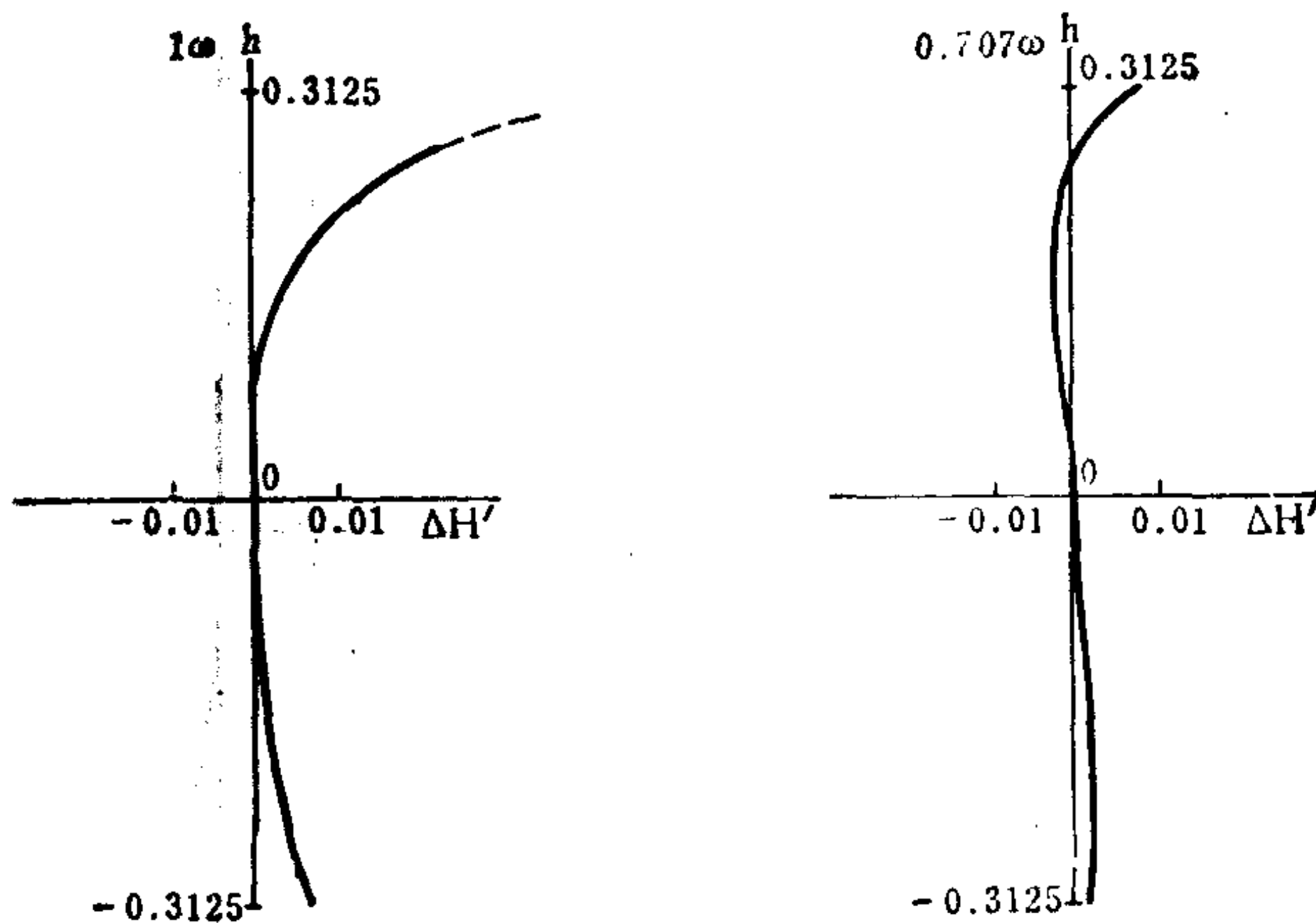
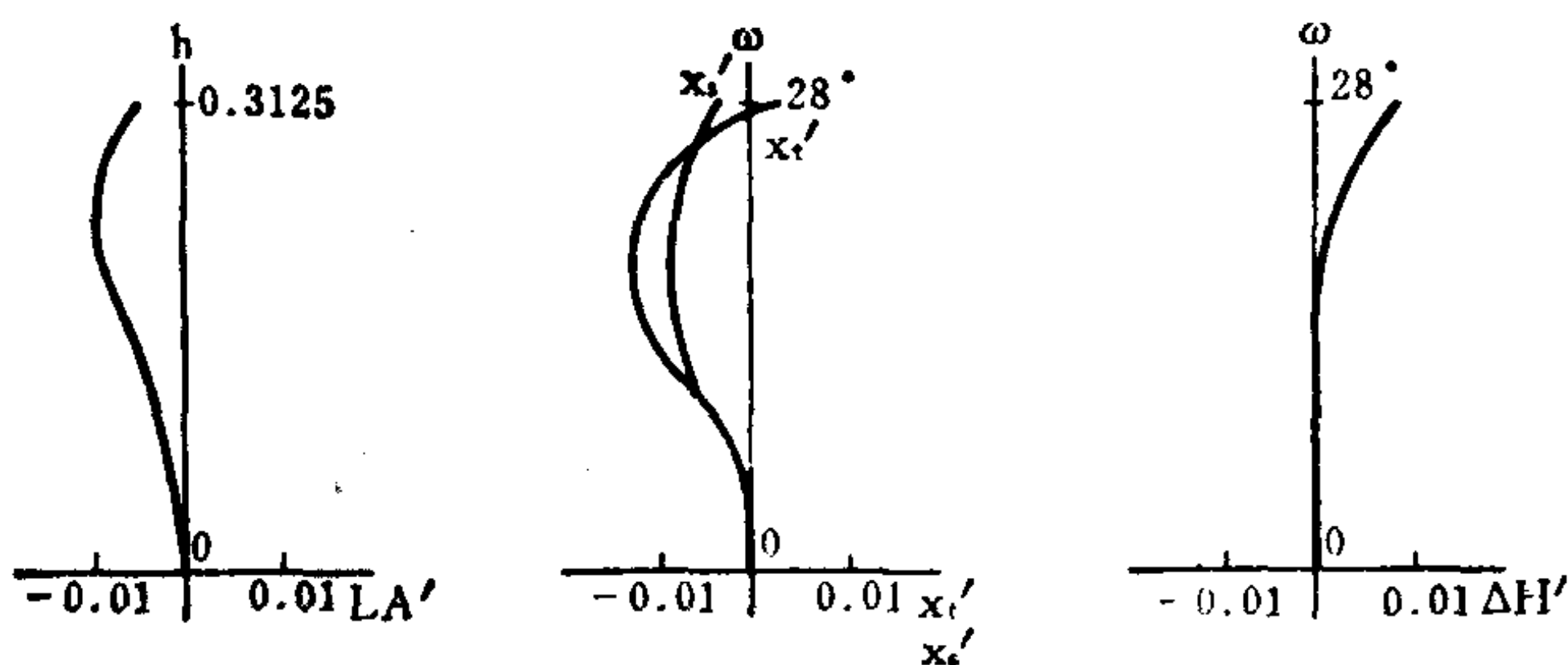

编号: 07-00-006

大 孔 径 照 相 物 镜

E. F. L = 100.2

B. F. L = 75.57

FNo. = 1.2

F. A. = $\pm 23^\circ$

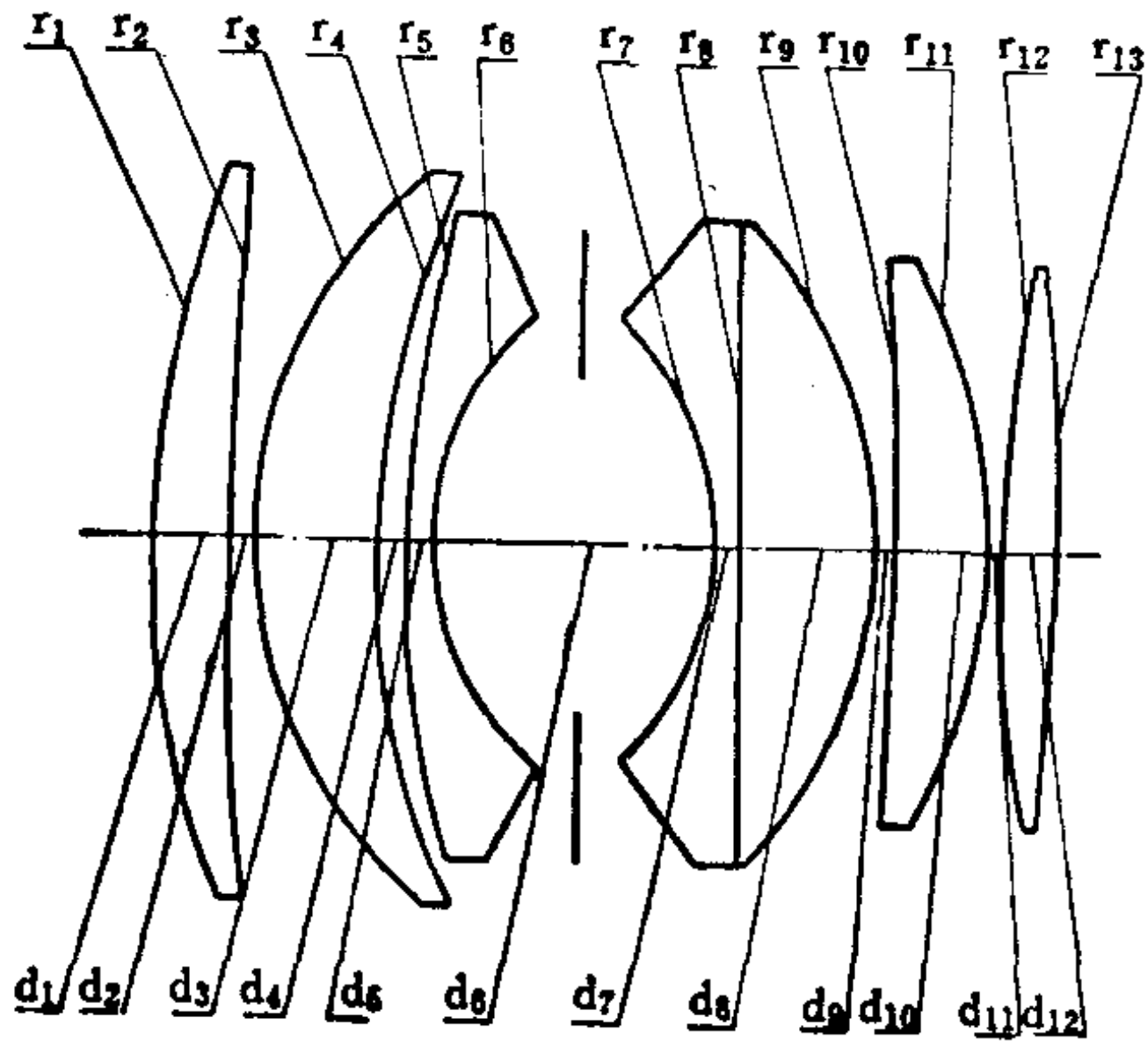

序号	r	d	nd	va	序号	r	d	nd	va
1	129.845	10.80	1.79631	40.8	8	∞	16.86	1.74443	49.4
2	1490.891	0.19			9	-55.039	0.19		
3	55.233	16.09	1.74400	44.9	10	-348.837	11.82	1.72000	50.2
4	116.279	2.91			11	-67.248	0.19		
5	168.605	2.91	1.68893	31.1	12	178.566	6.20	1.76684	46.6
6	35.252	34.50*			13	-503.465			
7	-35.271	2.13	1.78470	26.1					

34.50* = 17.25 + 17.25

	ΣS_1	ΣS_2	ΣS_3	ΣS_4	ΣS_5	HI	QP (1 ω)
	-0.2742	-0.0282	0.1267	-0.4307	-0.8312	42.56	-2.1%
h 或 ω %	LA'	$\Delta H'$	x'_i	x'_s	$x'_i - x'_s$	K'_{T1}	$K'_{T0.7}$
100	-0.0268	-0.890	-0.833	0.066	-0.899	-0.0339	-0.2861
70	-0.0680	-0.367	-0.157	-0.247	0.090	0.2710	-0.0947

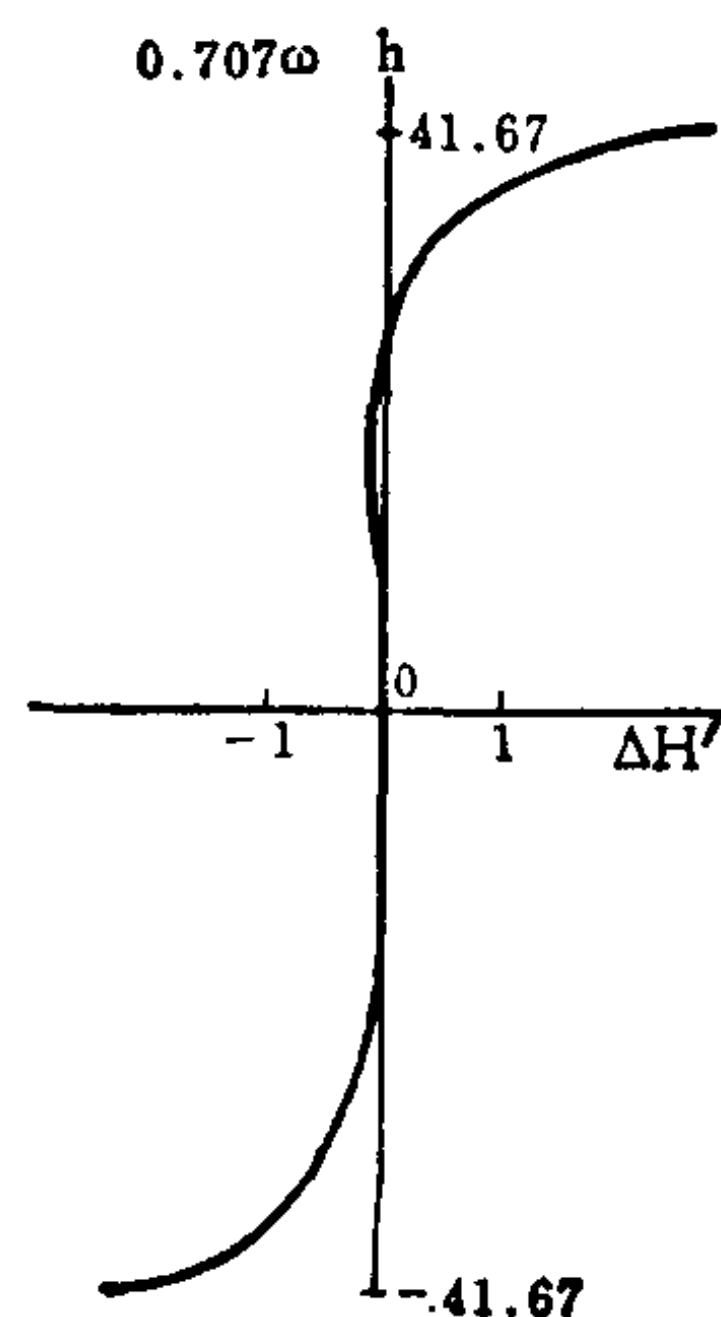
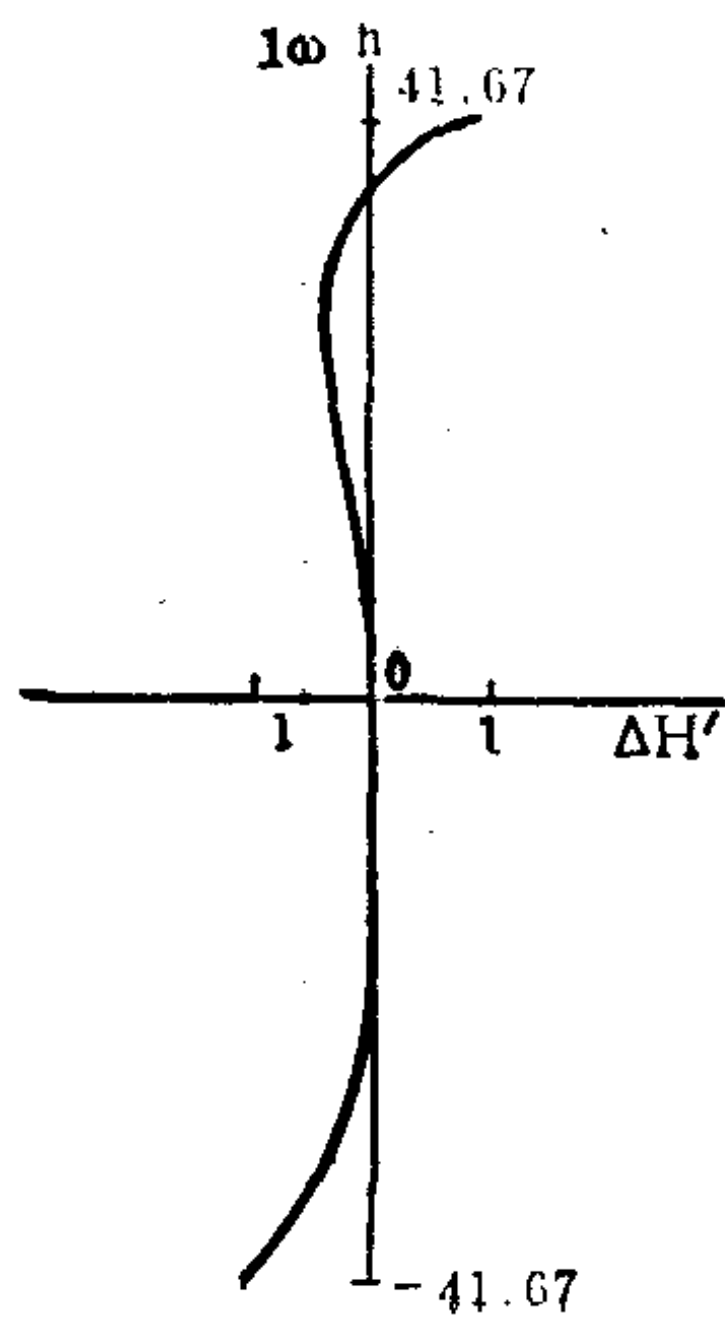
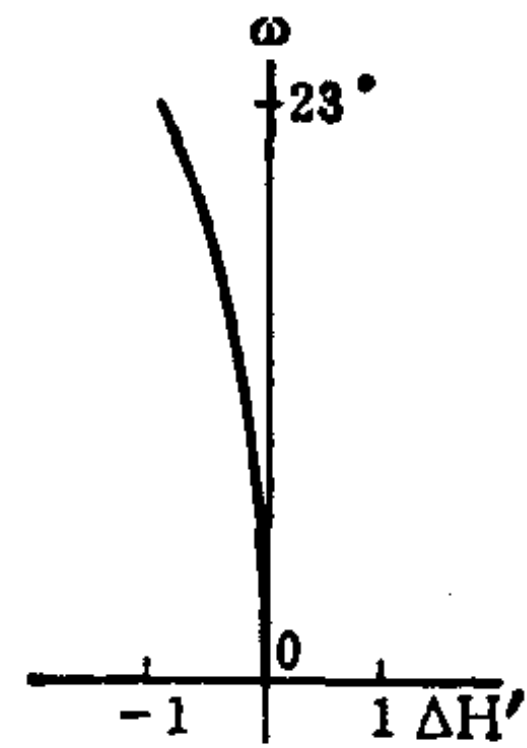
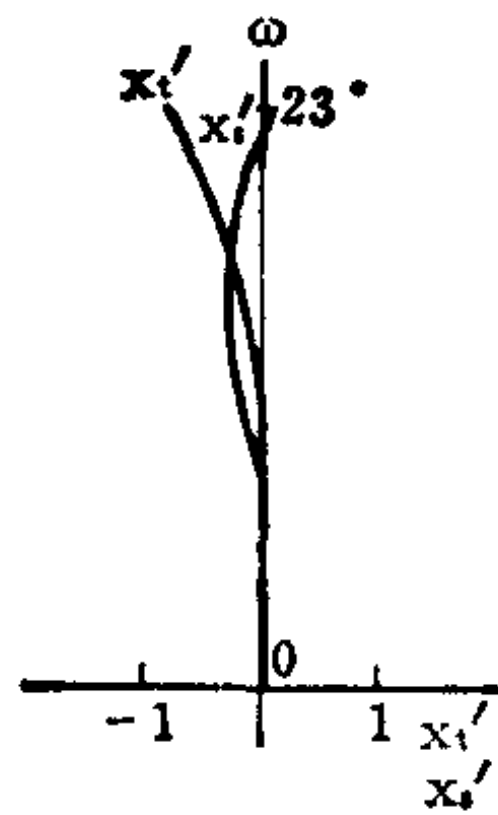
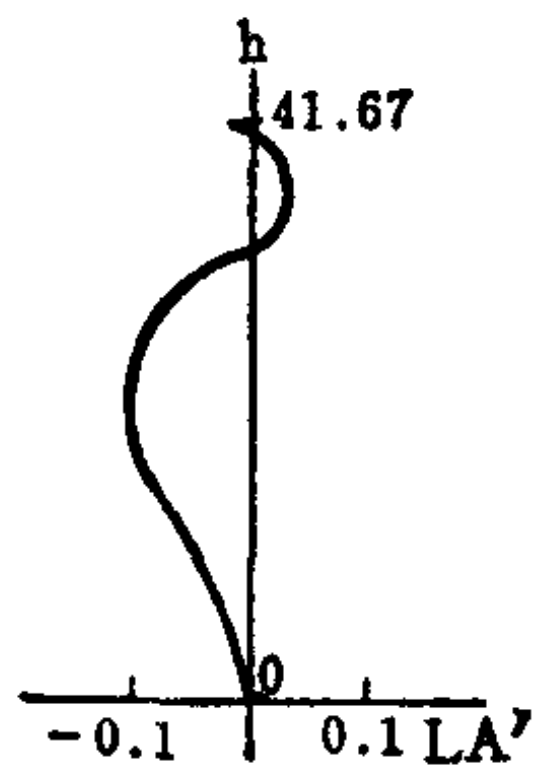

编号: 07-00-007

小型远摄物镜

E. F. L = 99.2

B. F. L = 35.2

FNo. = 2.8

F. A. = $\pm 10.2^\circ$

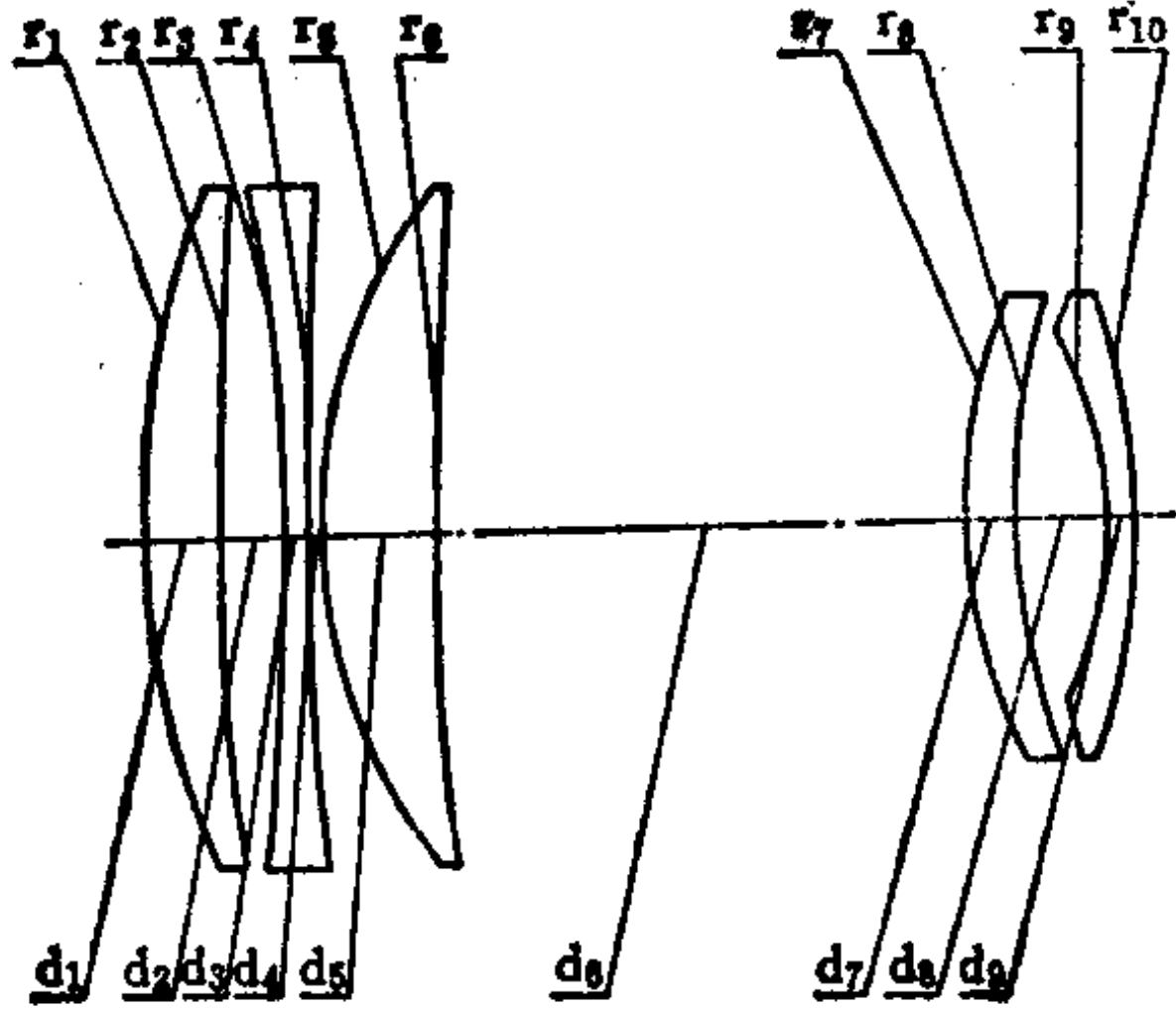

序号	r	d	n	v	序号	r	d	n	v
1	38.98	4.86	1.51821	65.0	6	134.14	28.84*		
2	145.48	3.19			7	30.61	2.88	1.80518	25.4
3	-112.72	1.68	1.80518	25.4	8	53.93	4.86		
4	209.73	0.08			9	-20.54	1.26	1.80610	40.9
5	30.94	5.81	1.55963	61.2	10	-56.03			

$28.84^* = 14.42 + 14.42$

	ΣS_1	ΣS_2	ΣS_3	ΣS_4	ΣS_5	HI	QP (1 ω)
	-0.02295	-0.01189	-0.00216	-0.01786	0.06655	17.8	0.8%
h 或 ω %	LA'	$\Delta H'$	x'_t	x'_s	$x'_t - x'_s$	K'_{T1}	$K'_{T0.7}$
100	-0.0559	0.153	-0.103	-0.215	0.112	0.5071	0.0935
70	-0.0798	0.060	-0.117	-0.133	0.016	0.2090	0.0208

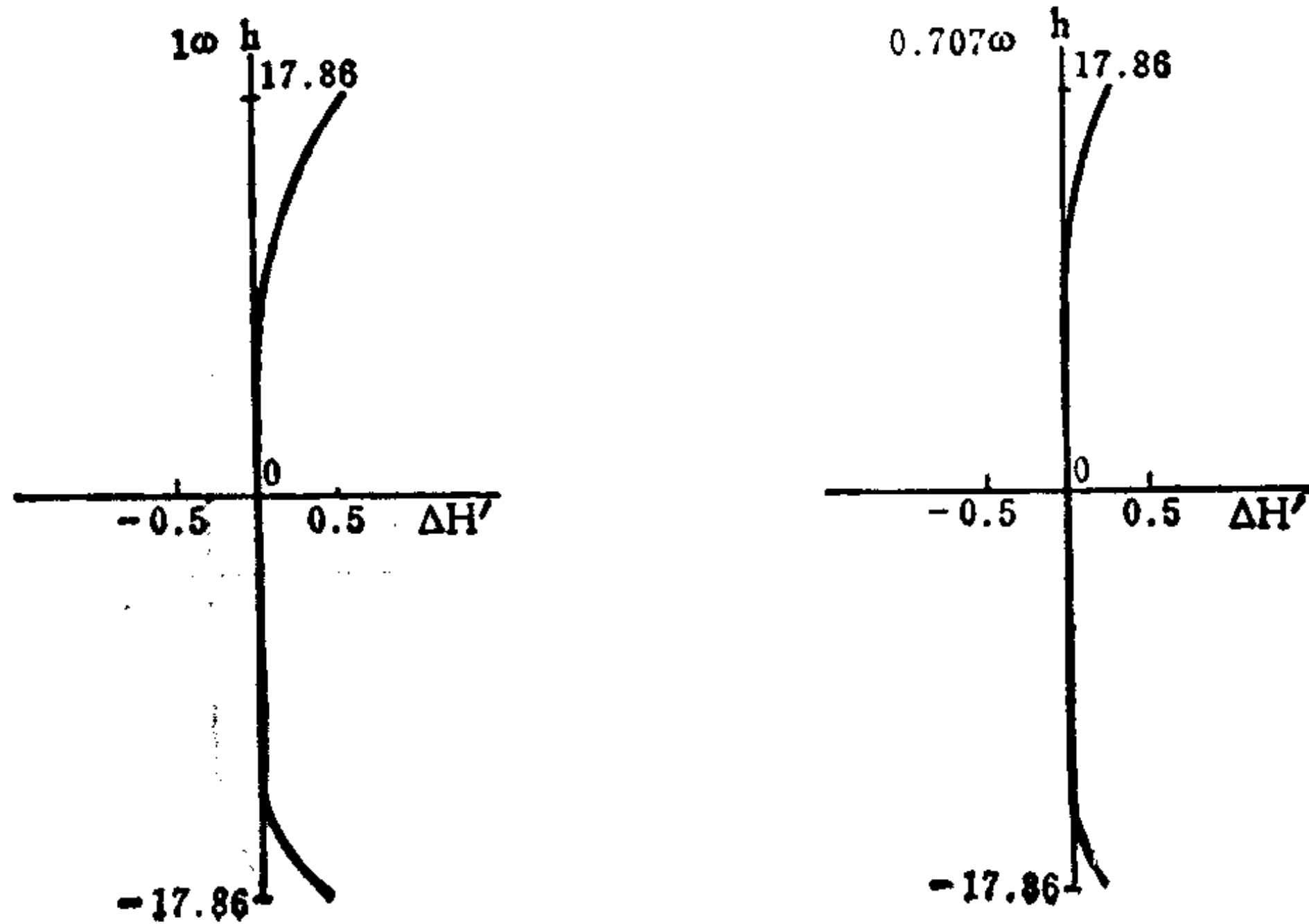
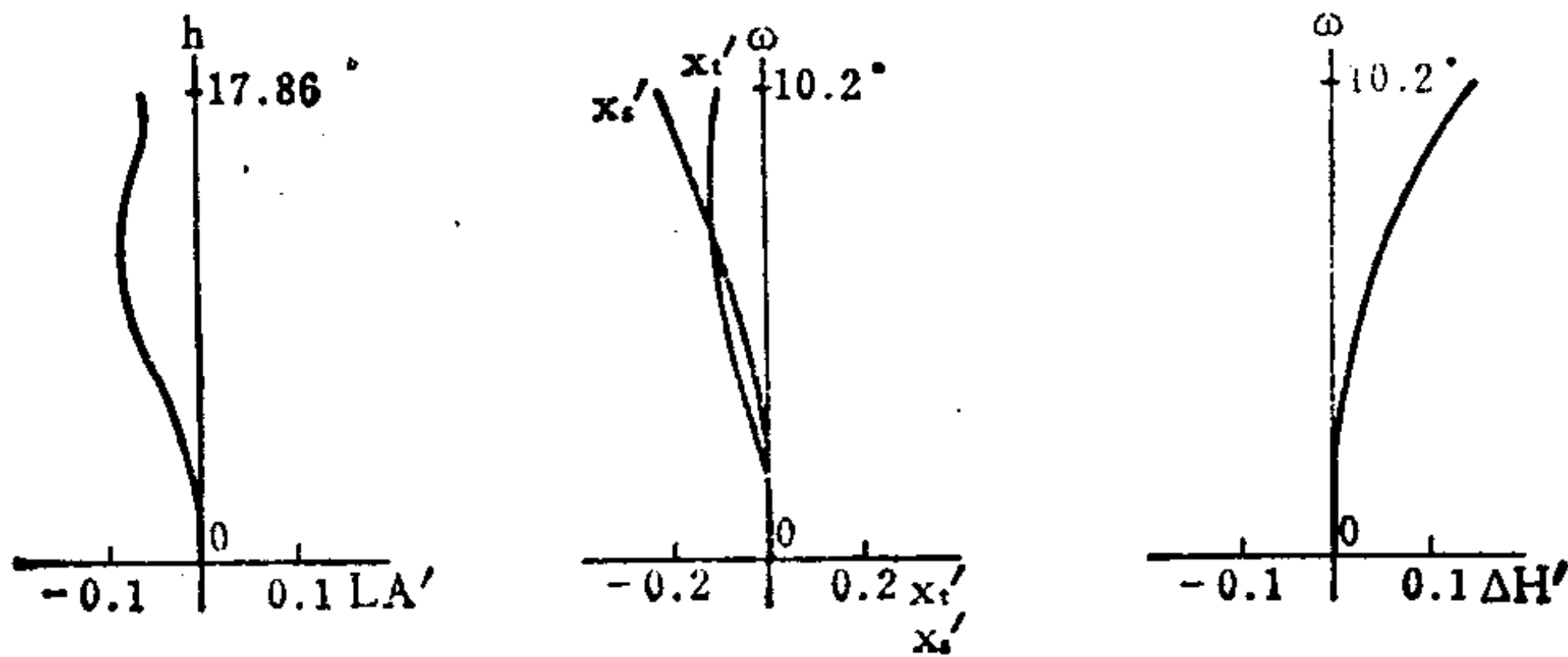

编号: 07-00-008

高斯型放大制版物镜

E. F. L = 100

B. F. L = 54

FNo. = 2

F. A. = ± 25°

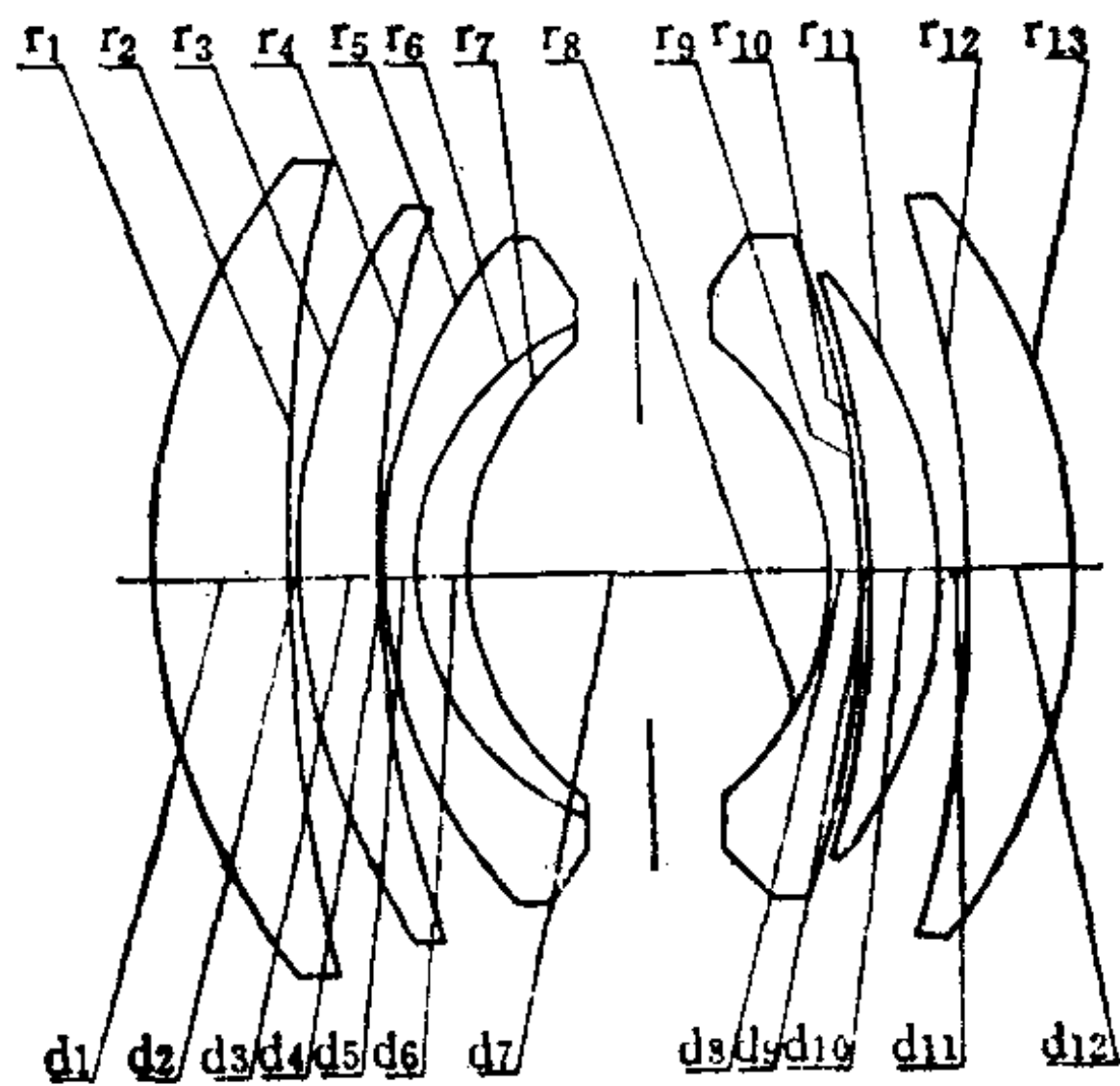

序号	r	d	n	v	序号	r	d	n	v
1	44.506	9.212	1.6031	60.7	8	-20.661	2.632	1.7400	31.7
2	120.873	0.392			9	-64.297	0.329		
3	44.95	5.264	1.6031	60.7	10	-62.544	5.264	1.6516	58.7
4	75.714	0.329			11	-30.053	1.645		
5	34.010	2.303	1.5927	35.3	12	-96.008	7.567	1.7570	47.9
6	17.994	3.948	1.7130	53.9	13	-37.835			
7	20.178	24.346*							

24.346* = 12.173 + 12.173

	ΣS_1	ΣS_2	ΣS_3	ΣS_4	ΣS_5	HI	QP (1 ω)
	0.2404	-0.2426	-0.5372	-0.1401	1.9344	46.6	12.7%
h 或 ω %	LA'	$\Delta H'$	x'_t	x'_s	$x'_t - x'_s$	K'_{T1}	$K'_{T0.7}$
100	6.554	5.930	-25.93	-7.42	-18.51	2.087	0.500
70	1.700	1.600	-10.00	-3.35	-6.65	-0.393	-0.231

注, 1. 以上象差值是按 $d_2 = 0.392$, $l = -\infty$ 计算的。

2. 改变 d_2 , 实现 $M = 4^* (NA = 0.029) \sim 8^*$ 。

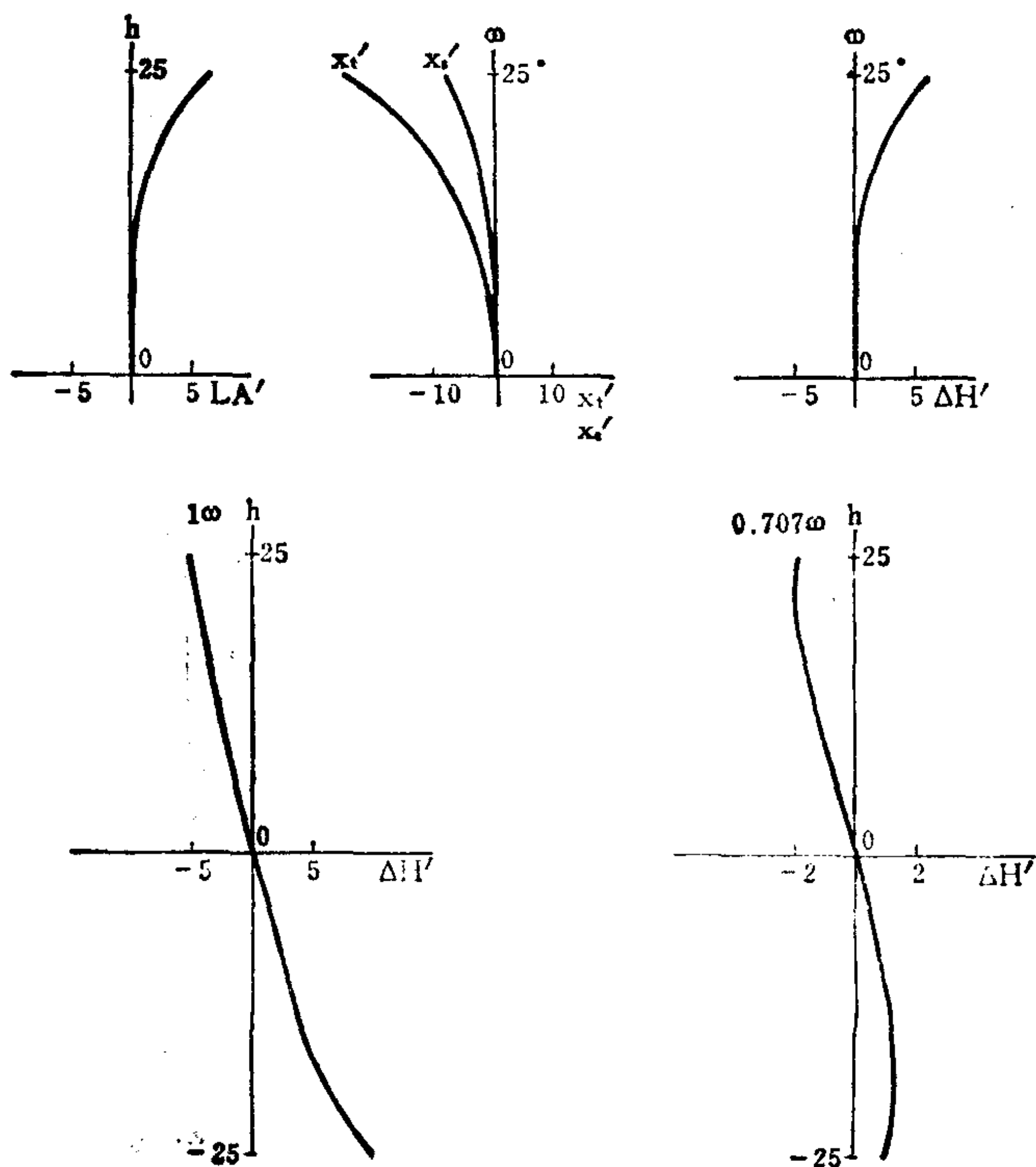

高斯型放大制版物镜

E. F. L = 100

B. F. L = 54.25

FNo. = 2

F. A. = ± 25°

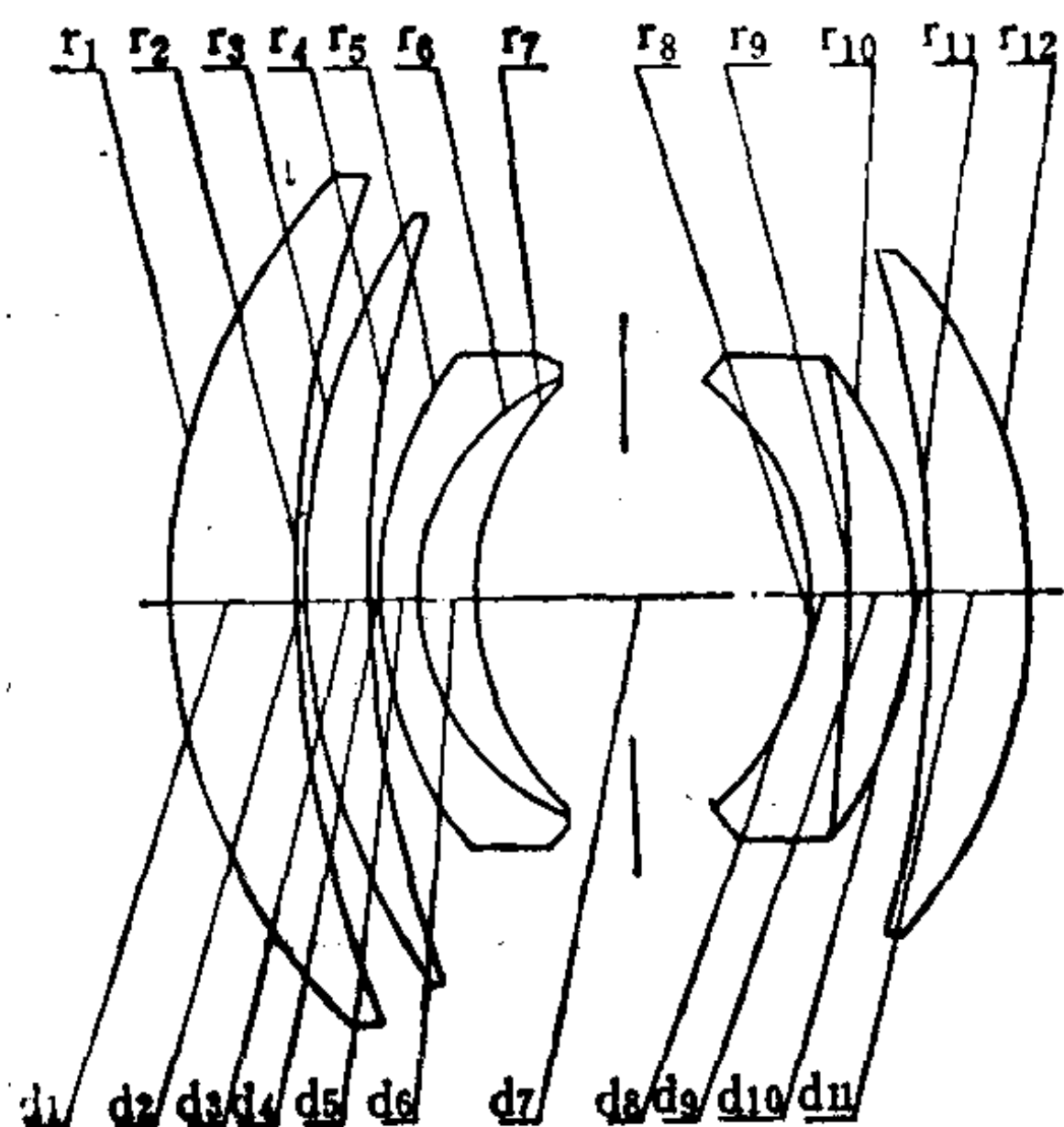

序号	r	d	n	v	序号	r	d	n	v
1	43.438	9.030	1.6031	60.7	7	19.767	24.510*		
2	86.163	0.323			8	-19.187	2.580	1.7495	35.2
3	47.660	5.160	1.6031	60.7	9	-90.487	5.160	1.6385	55.4
4	94.984	0.323			10	-27.870	1.613		
5	31.502	2.258	1.5927	35.3	11	-92.546	7.418	1.7570	47.9
6	16.622	3.870	1.7340	51.5	12	-36.289			

24.510* = 12.250 + 12.260

	ΣS_1	ΣS_2	ΣS_3	ΣS_4	ΣS_5	HI	QP (1 ω)
	0.2686	-0.2889	-0.4552	-0.1120	1.7034	46.6	10.9%
h 或 ω %	LA'	$\Delta H'$	x'_t	x'_s	$x'_t - x'_s$	K'_{T1}	$K'_{T0.7}$
100	11.731	5.118	-21.30	-6.16	-15.14	1.1677	0.1638
70	2.296	1.425	-8.50	-2.83	-5.67	-1.1836	-0.4159

注: 1. 以上象差值是按 $d_2 = 0.323$, $l = -\infty$ 计算的。
 2. 改变 d_2 , 实现 $M = 4^* (NA = 0.028) \sim 8^*$ 。

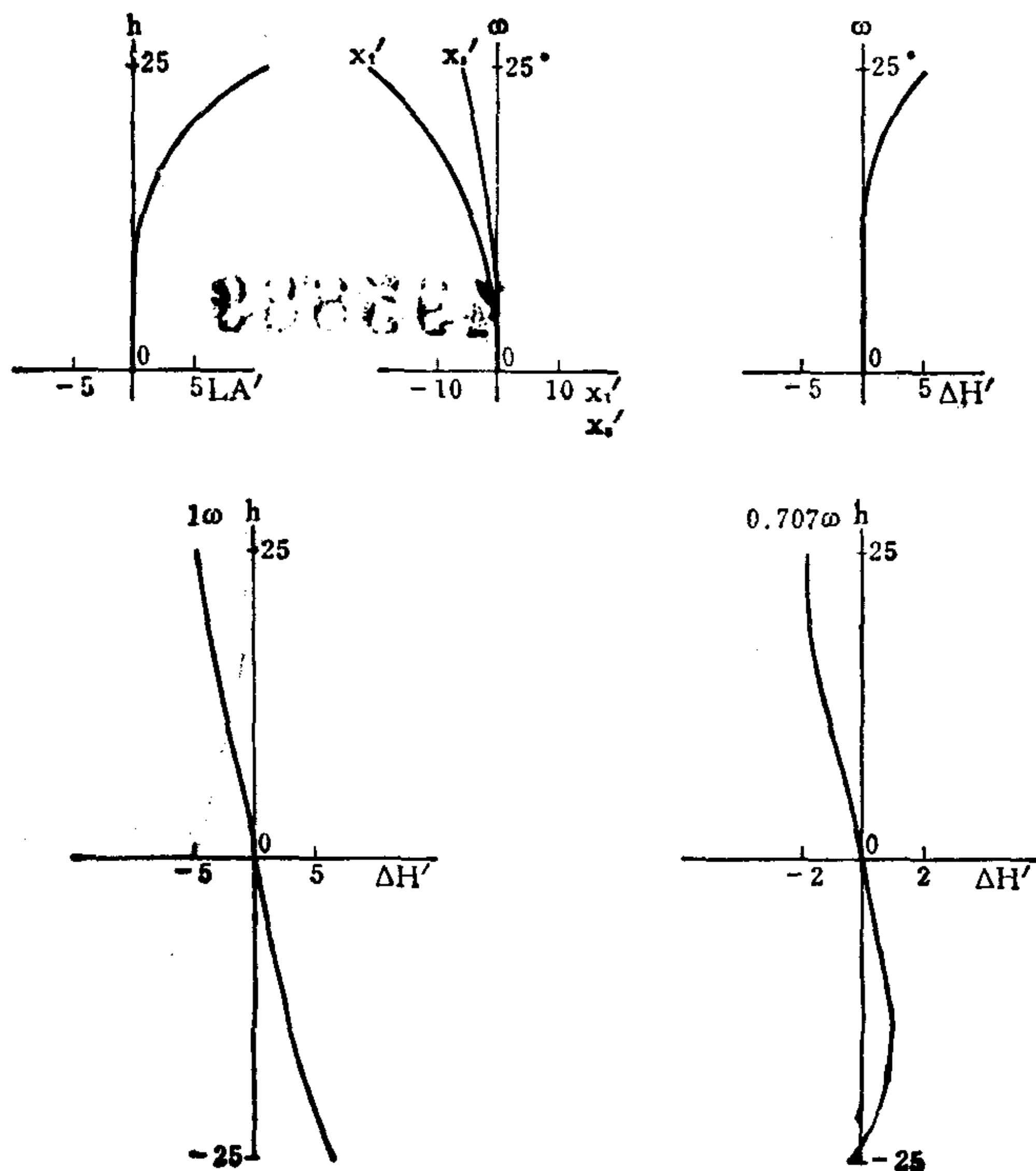

编号: 07-00-010

大口径远摄物镜

E. F. L = 100

B. F. L = 23.73

FNo. = 2.8

F. A. = $\pm 4.12^\circ$

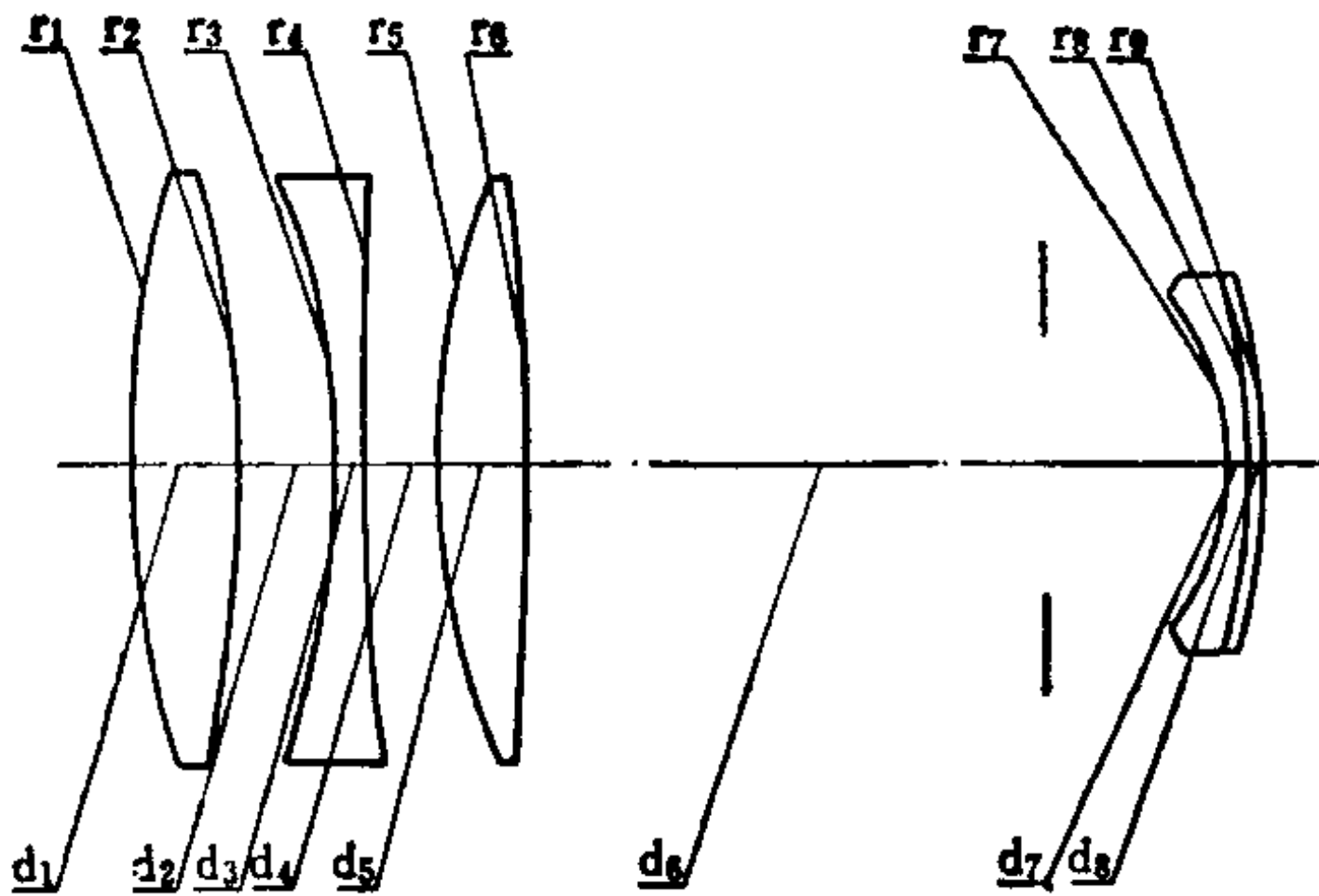

序号	r	d	n	v	序号	r	d	n	v
1	40.5860	7.4978	1.43387	95.1	6	-174.7872	41.1339*		
2	-64.2620	5.0632			7	-15.9528	0.6936	1.51633	64.1
3	-48.2052	1.7929	1.78590	44.2	8	-63.1176	1.2484	1.72151	29.2
4	269.4636	3.4680			9	-34.8221			
5	38.0994	5.5696	1.48749	70.1					

$41.1339^* = 30.0000 + 11.1339$

	ΣS_1	ΣS_2	ΣS_3	ΣS_4	ΣS_5	HI	QP (1 ω)
	-0.01106	0.00387	-0.00200	-0.00218	0.02154	7.2	0.8%
h 或 ω %	LA'	$\Delta H'$	x'_i	x'_s	$x'_i - x'_s$	K'_{T1}	$K'_{T0.7}$
100	0.0173	0.0602	-0.0361	-0.0487	0.0126	3.3447	0.0702
70	-0.0169	0.0213	-0.0375	-0.0281	-0.0094	0.3879	0.0018

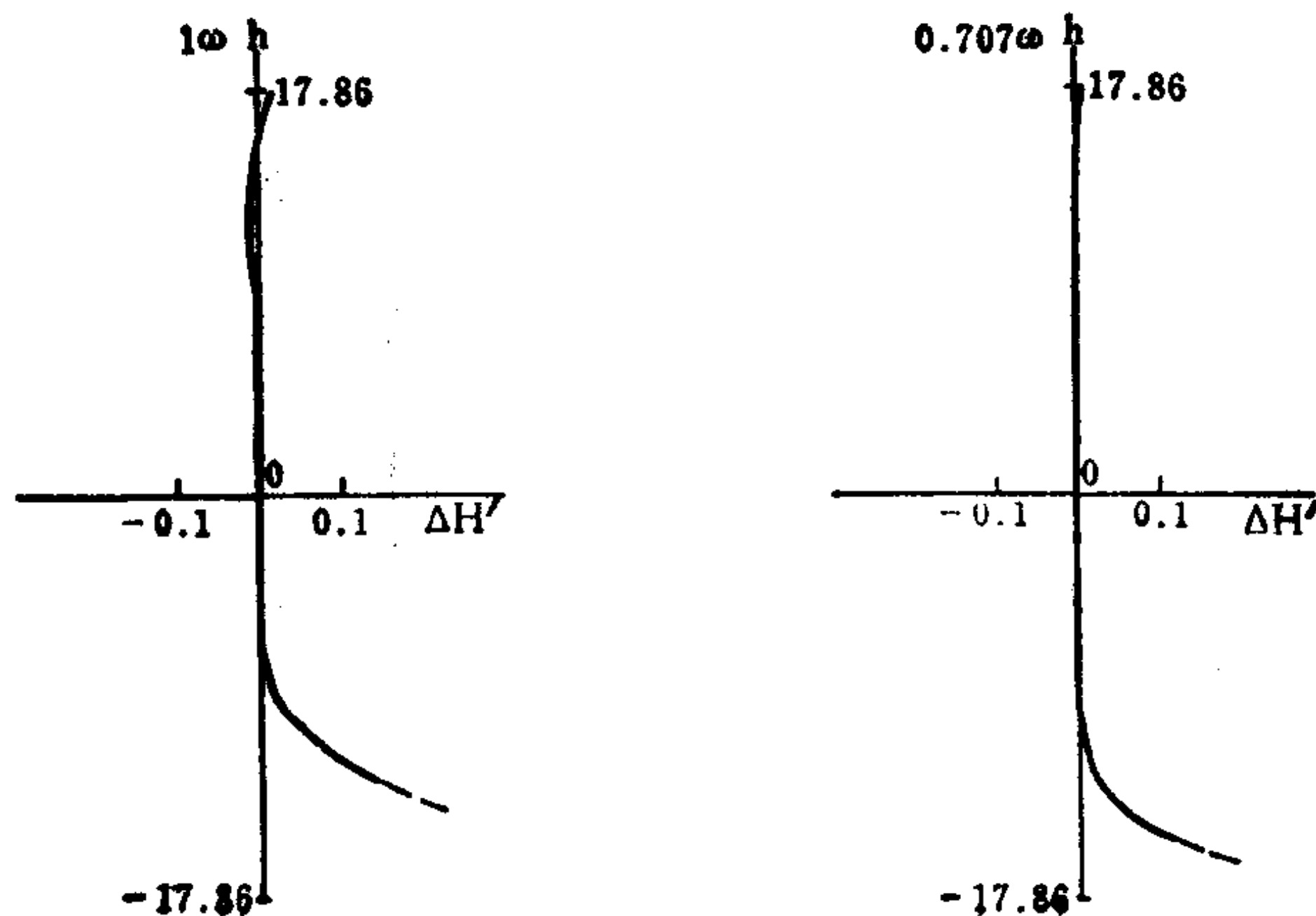
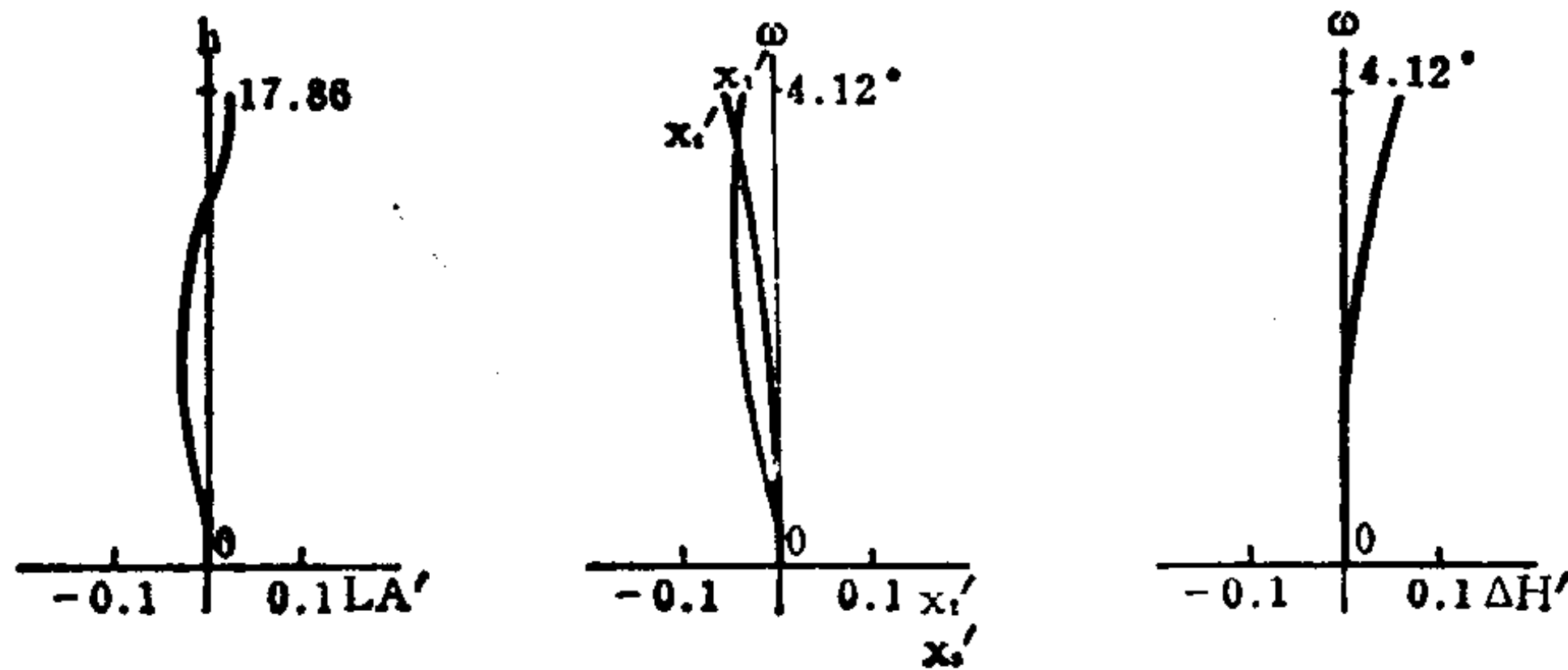

编号: 07-00-011

远 摄 物 镜

E. F. L = 1

B. F. L = 0.36

FNo. = 2.8

F. A. = ± 12°

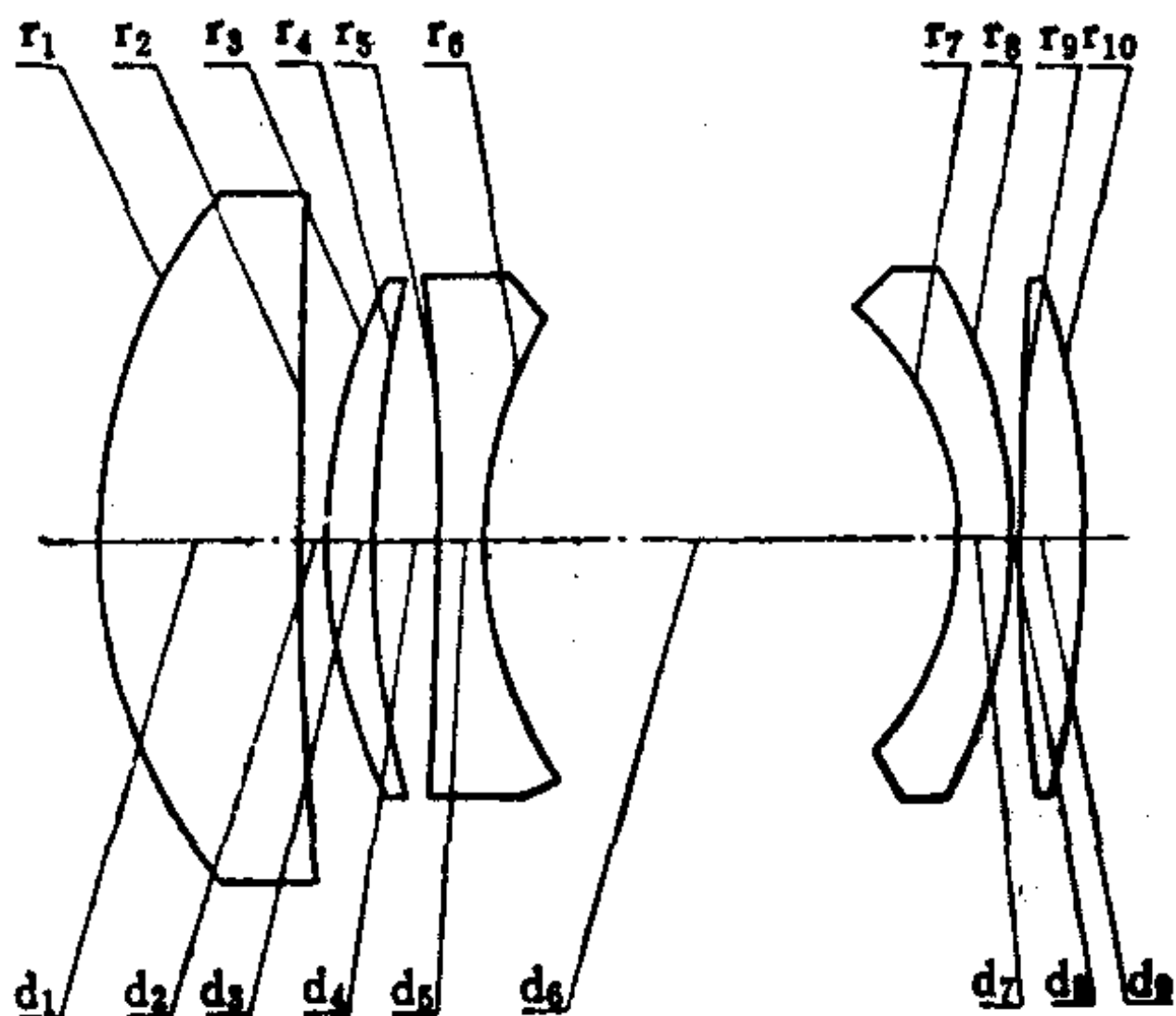

序号	r	d	n	v	序号	r	d	n	v
1	0.31245	0.12459	1.62041	60.2	6	0.24769	0.27499*		
2	24.05484	0.00400			7	-0.18235	0.03000	1.58913	61.0
3	0.30835	0.03099	1.58913	61.0	8	-0.31186	0.00200		
4	0.63555	0.03400			9	3.31487	0.03650	1.72342	37.9
5	-3.21278	0.03485	1.71736	29.5	10	-0.53436			

$0.27499^* = 0.14000 + 0.13499$

	ΣS_1	ΣS_2	ΣS_3	ΣS_4	ΣS_5	HI	QP (1 ω)
	-0.000195	0.000129	-0.000071	-0.000109	0.001193	0.21	1.5%
h 或 ω %	LA'	$\Delta H'$	x'_i	x'_s	$x'_i - x'_s$	K'_{f1}	$K'_{f0.7}$
100	0.00143	0.00332	-0.00392	-0.00091	-0.00301	-0.17208	0.00374
70	-0.00065	0.00115	-0.00096	-0.00081	-0.00015	-0.00279	-0.00032

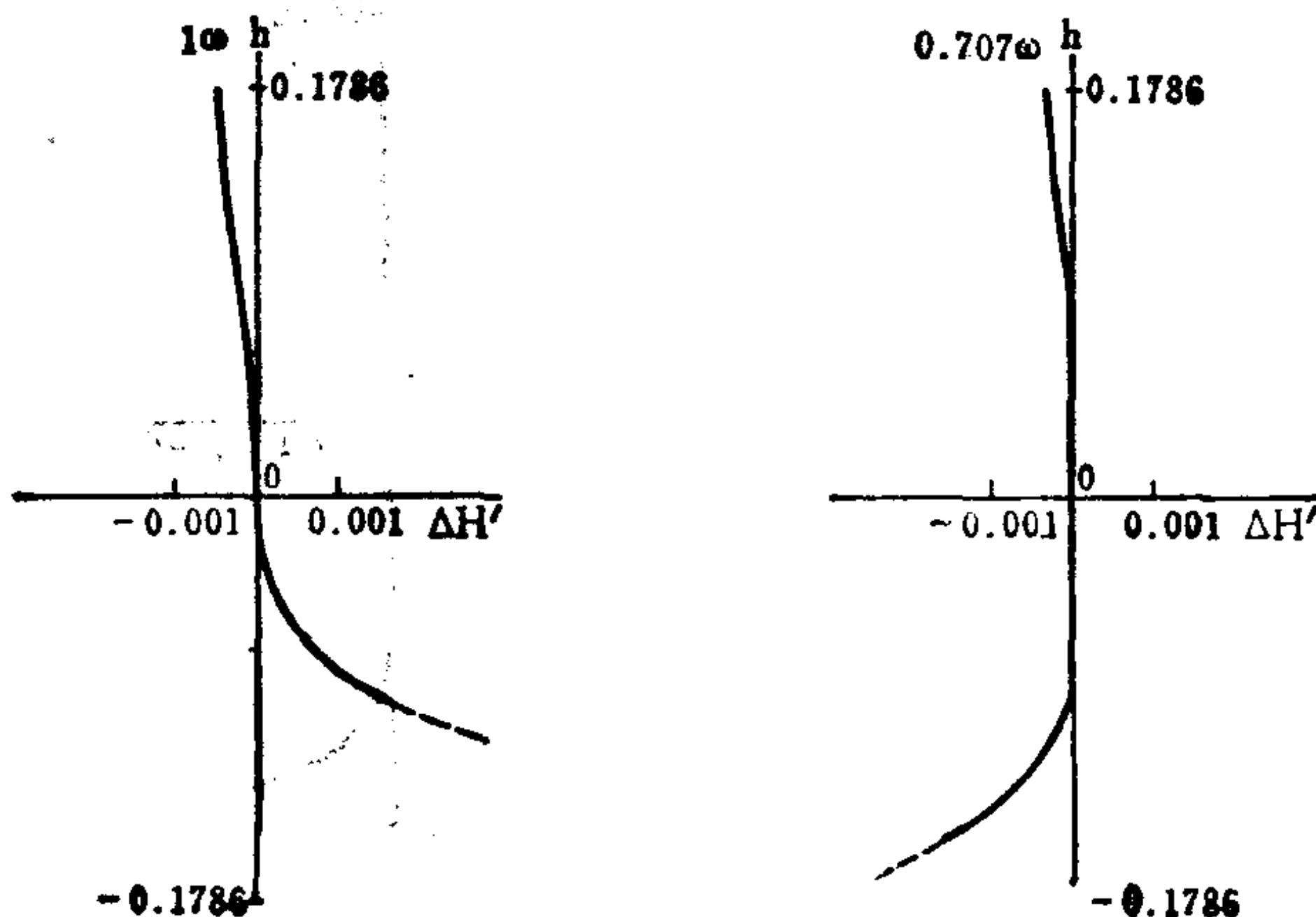
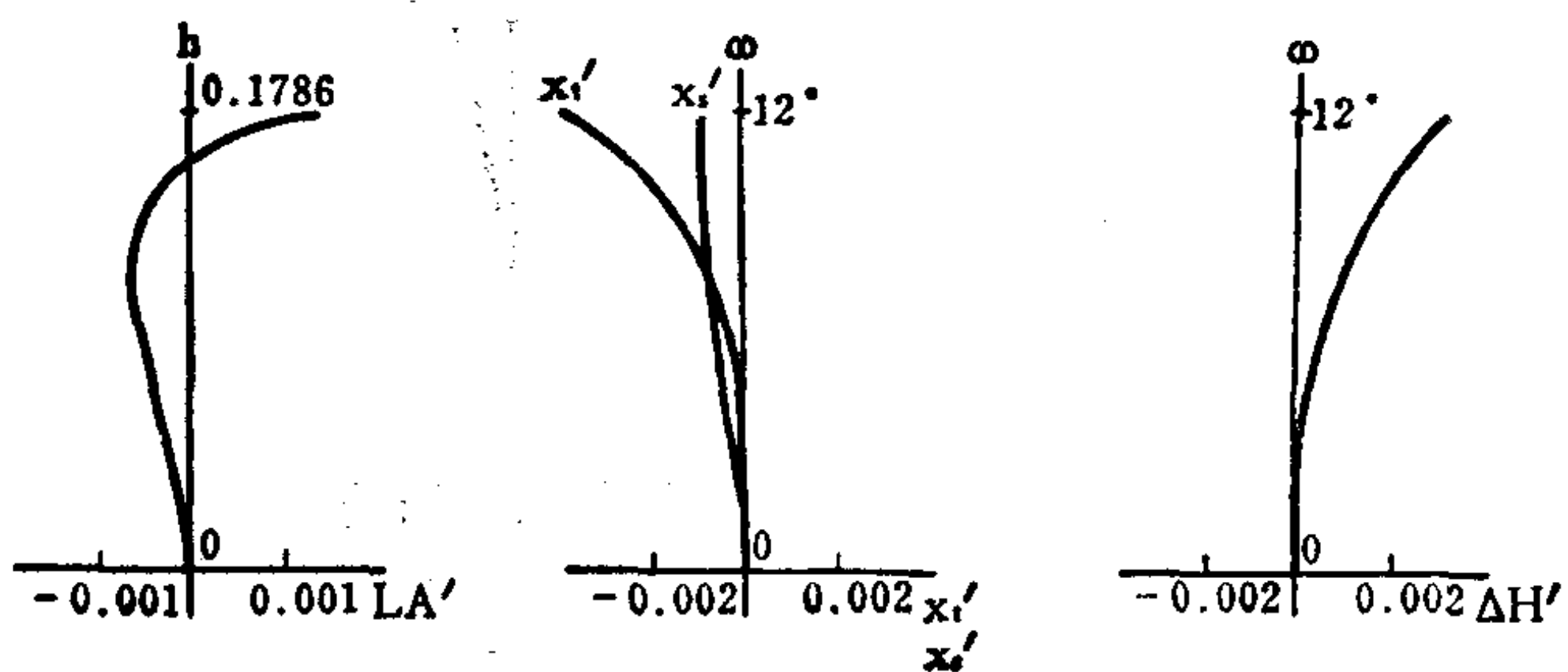

编号: 07-00-012

照 相 物 镜

E. F. L = 1

B. F. L = 0.7187

FNo. = 1.7

F. A. = ± 23°

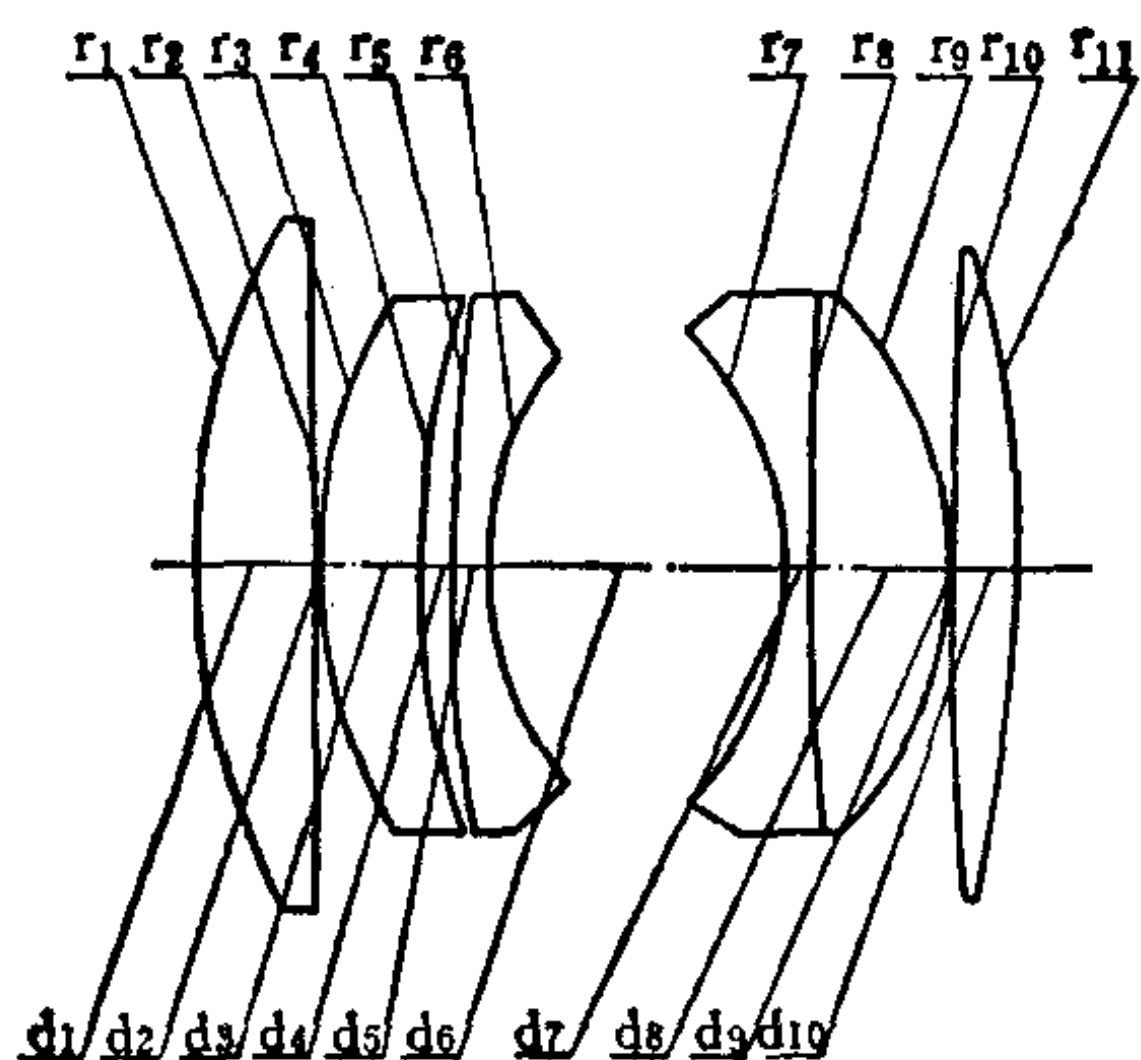

序号	r	d	n	v _d	序号	r	d	n	v _d
1	0.6102	0.1050	1.62299	58.2	7	-0.3002	0.0200	1.69895	30.1
2	6.5307	0.0020			8	3.6790	0.1200	1.65844	50.9
3	0.4429	0.0900	1.67003	47.3	9	-0.3623	0.0020		
4	0.7880	0.0200			10	2.4480	0.0580	1.80610	40.8
5	1.7250	0.0301	1.61293	37.0	11	-1.0667			
6	0.2908	0.2560*							

0.2560* = 0.1280 + 0.1280

	ΣS ₁	ΣS ₂	ΣS ₃	ΣS ₄	ΣS ₅	HI	QP (1ω)
	-0.001073	-0.000047	0.000741	-0.002675	-0.001868	0.42	-1.2%
h 或 ω %	LA'	ΔH'	x' _t	x' _s	x' _t - x' _s	K _{T1}	K _{T0.7}
100	0.00548	-0.00523	-0.00412	0.00119	-0.00531	0.00393	0.00104
70	-0.00073	-0.00151	-0.00132	-0.00310	0.00178	0.00488	0.00094

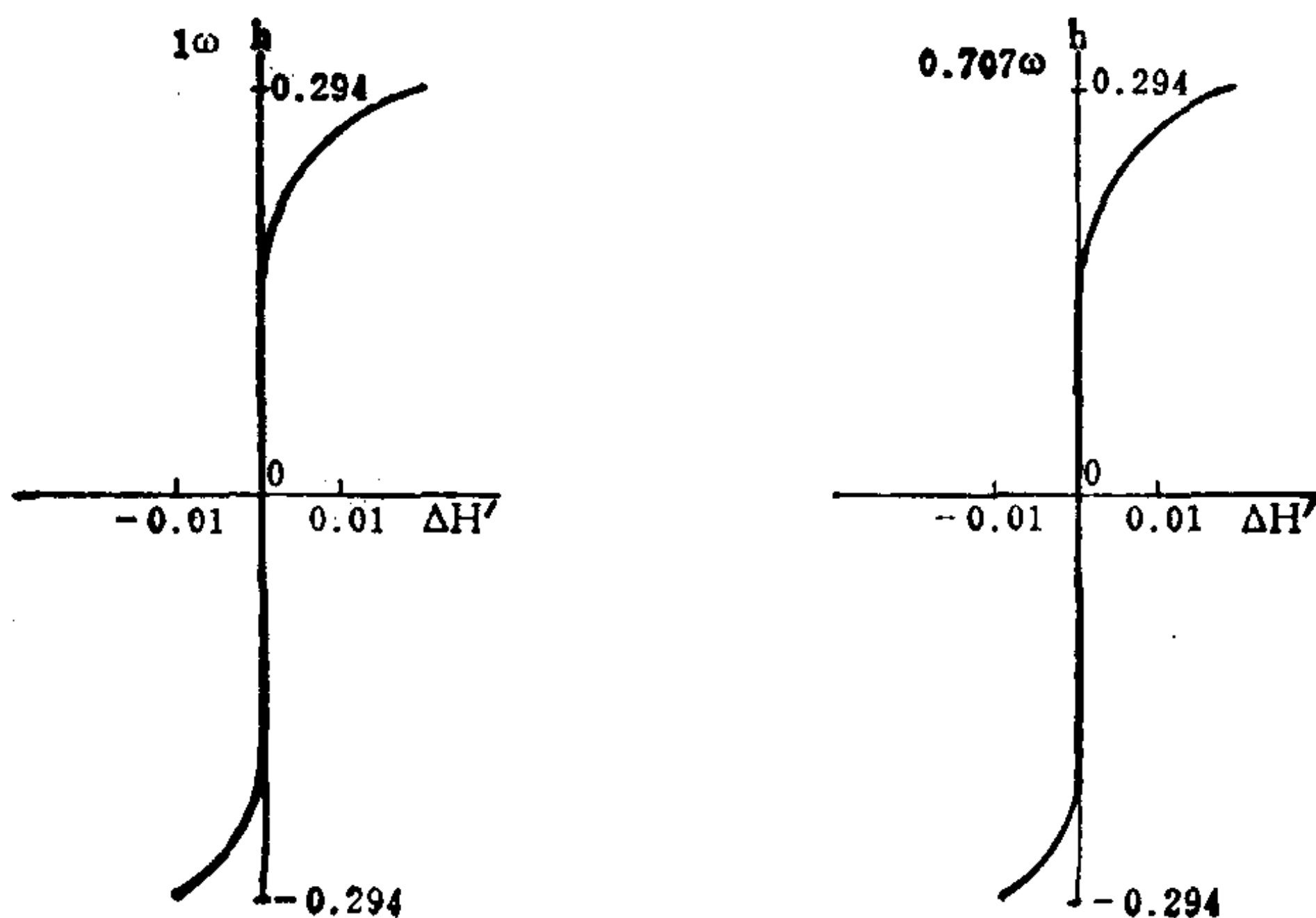
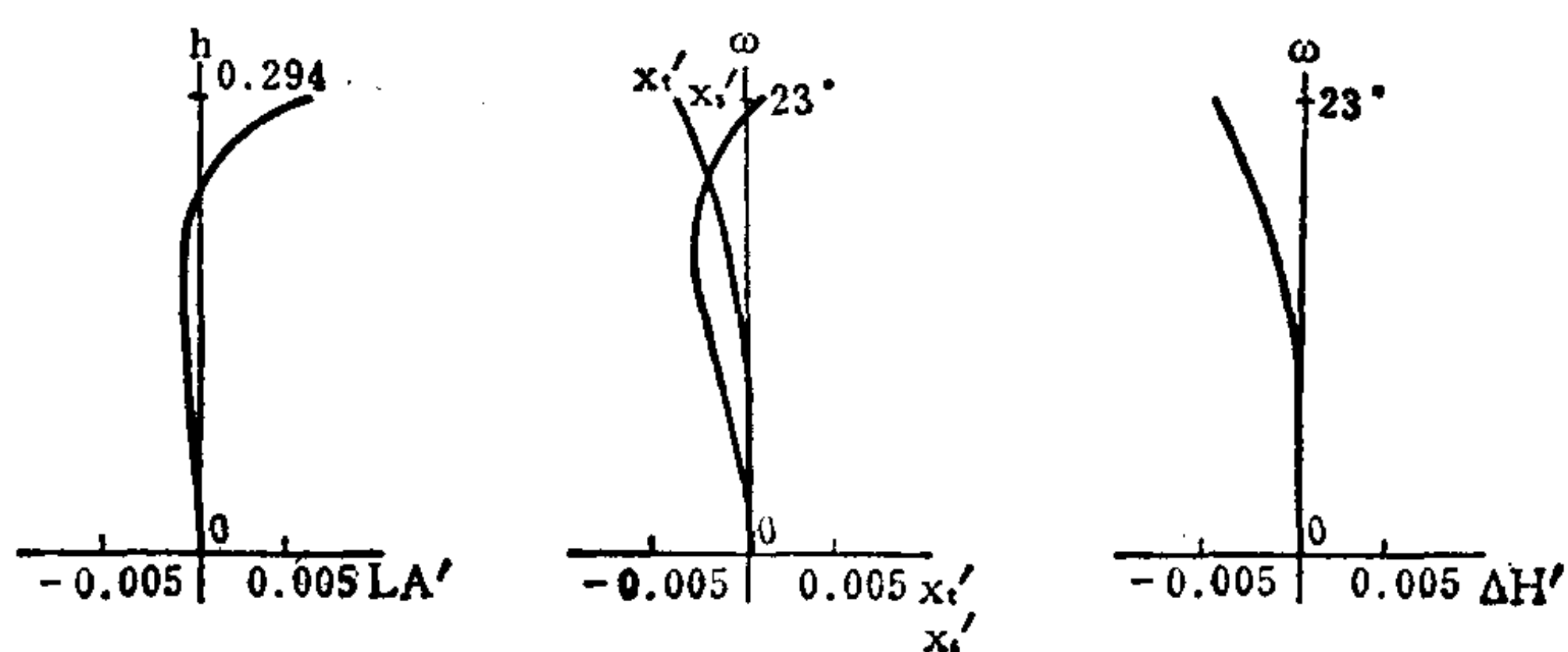

编号: 07-00-013

照 相 物 镜

E. F. L = 1

B. F. L = 0.7196

FNo. = 1.7

F. A. = ± 23°

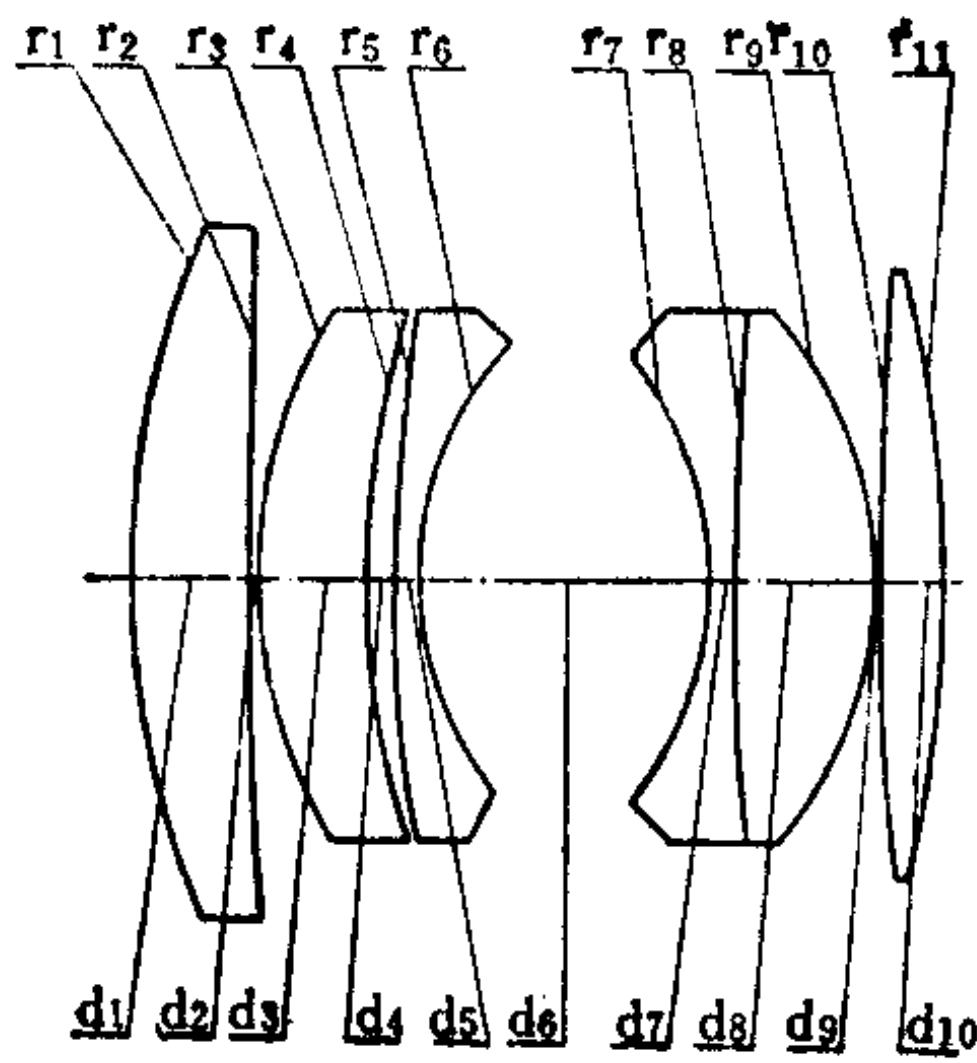

序号	r	d	n	v _d	序号	r	d	n	v _d
1	0.6610	0.1050	1.62299	58.2	7	-0.3044	0.0200	1.69895	30.1
2	6.9311	0.0020			8	3.4250	0.1200	1.65844	50.9
3	0.4525	0.0950	1.74400	44.8	9	-0.3665	0.0020		
4	0.7626	0.0200			10	2.4620	0.0600	1.80610	40.8
5	1.5060	0.0300	1.62588	35.7	11	-1.0764			
6	0.2981	0.2500*							

0.2500* = 0.1250 + 0.1250

	ΣS ₁	ΣS ₂	ΣS ₃	ΣS ₄	ΣS ₅	HI	QP (1ω)
	-0.000950	-0.000092	0.000655	-0.002592	-0.001777	0.42	-1.2%
h 或 ω %	LA'	ΔH'	x _i '	x _s '	x _i ' - x _s '	K _{T1} '	K _{T0.7} '
100	0.00557	-0.00513	-0.00399	0.00141	-0.00540	0.00342	0.00099
70	-0.00051	-0.00146	-0.00166	-0.00306	0.00140	0.00394	0.00081

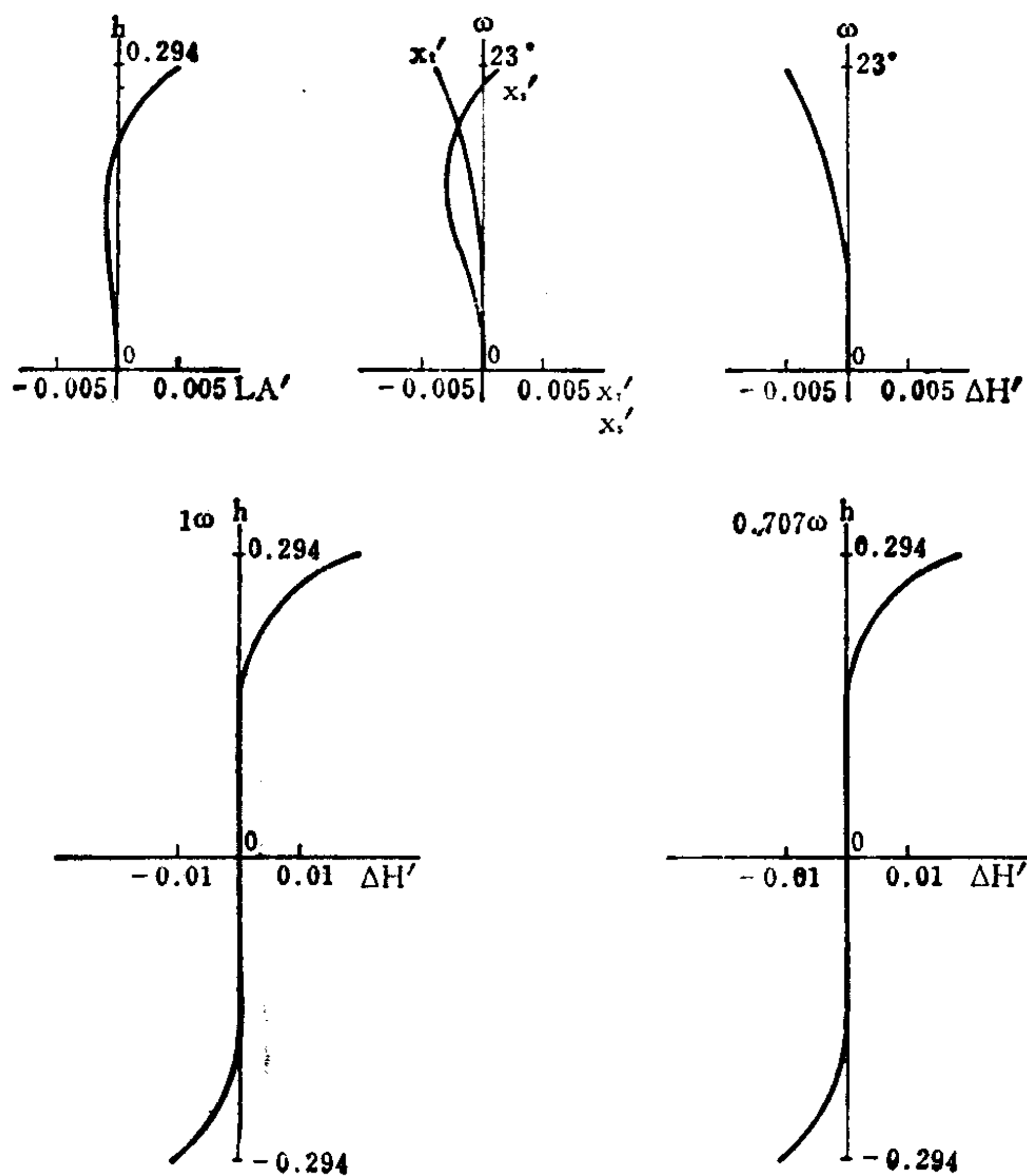

编号: 07-02-014

广角照相物镜

E. F. L = 97

B. F. L = 119.3

FNo. = 1.94

F. A. = ± 32°

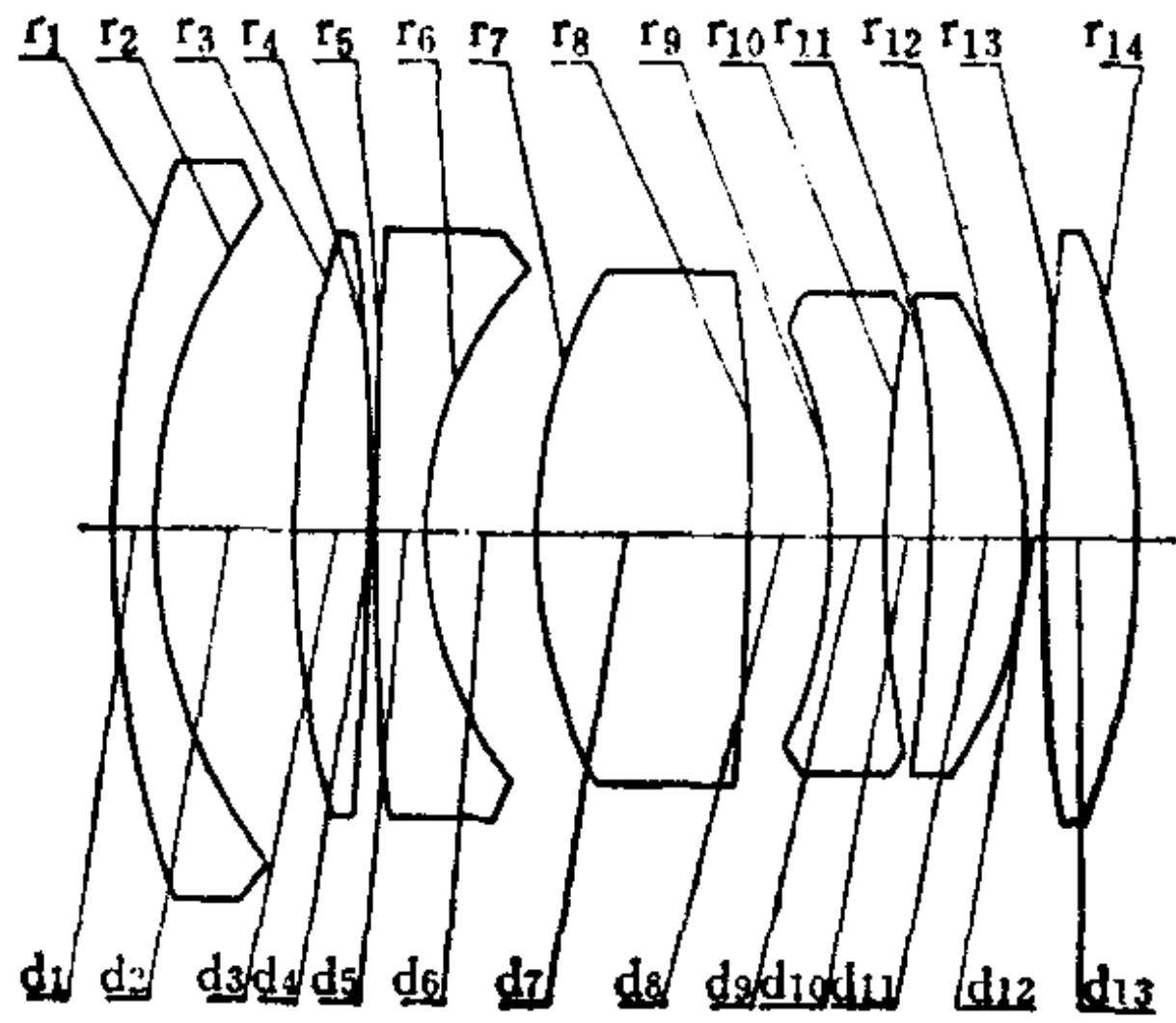

序号	r	d	n	v	序号	r	d	n	v
1	161.15	6.15	1.60738	56.8	8	-362.02	10.91*		
2	72.55	19.93			9	-69.86	7.23	1.80518	25.4
3	186.64	10.50	1.71300	53.9	10	152.00	6.69		
4	-402.24	0.59			11	-235.10	11.40	1.73400	51.5
5	1834.76	6.41	1.56873	63.1	12	-60.16	2.00		
6	49.54	14.12			13	381.07	12.45	1.64000	60.2
7	65.07	30.23	1.79952	42.2	14	-105.28			

10.91* = 5.00 + 5.91

	ΣS_1	ΣS_2	ΣS_3	ΣS_4	ΣS_5	HI	QP (1 ω)
	-0.1608	0.2604	-0.1654	-0.3481	-1.2669	60.6	-4.9%
h 或 ω %	LA'	$\Delta H'$	x'_t	x'_s	$x'_t - x'_s$	K'_{T1}	$K'_{T0.7}$
100	4.358	-2.977	-7.209	-2.277	-4.932	-1.0101	0.2282
70	0.551	-1.037	-3.463	-1.777	-1.686	-1.3835	0.2978

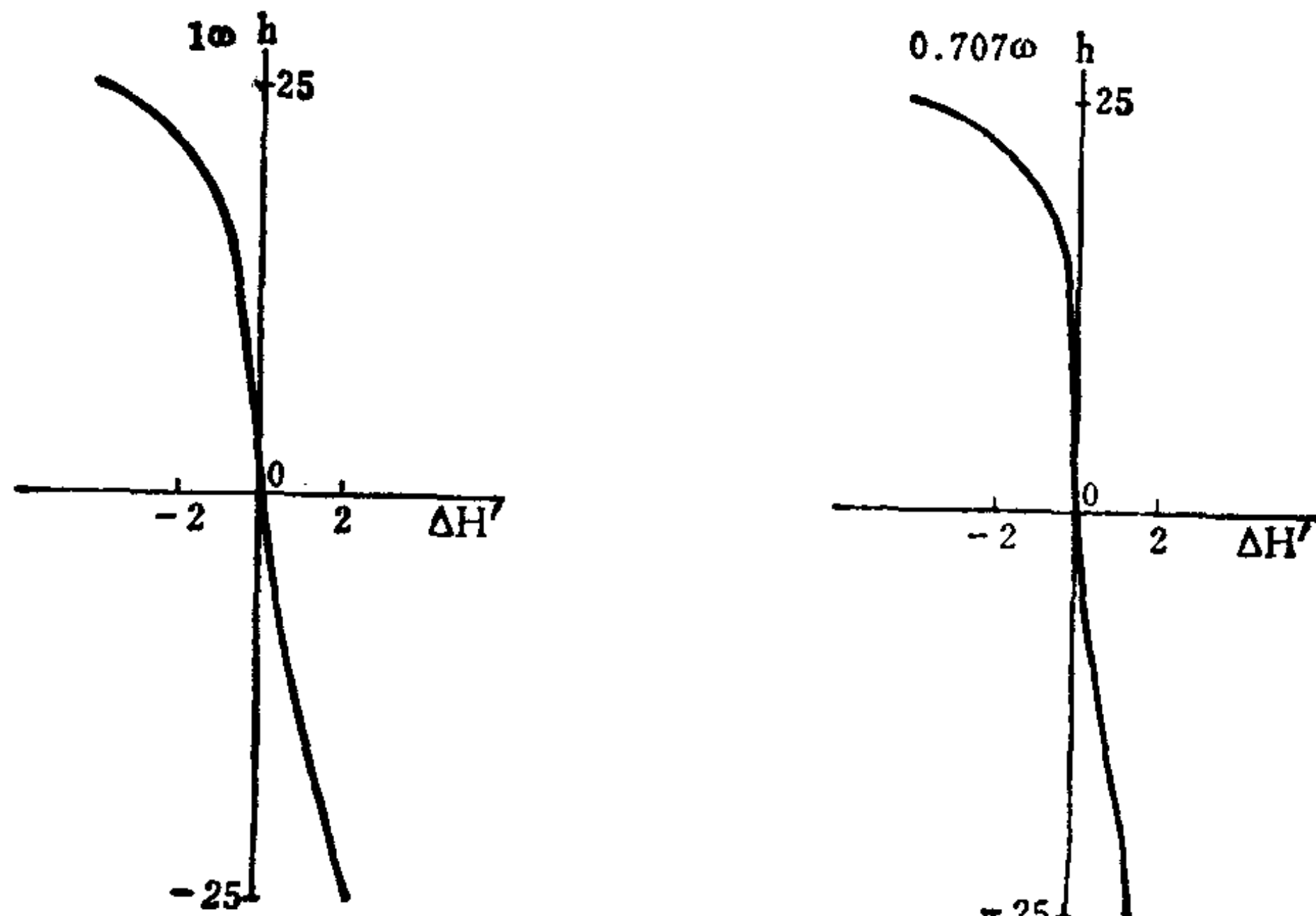
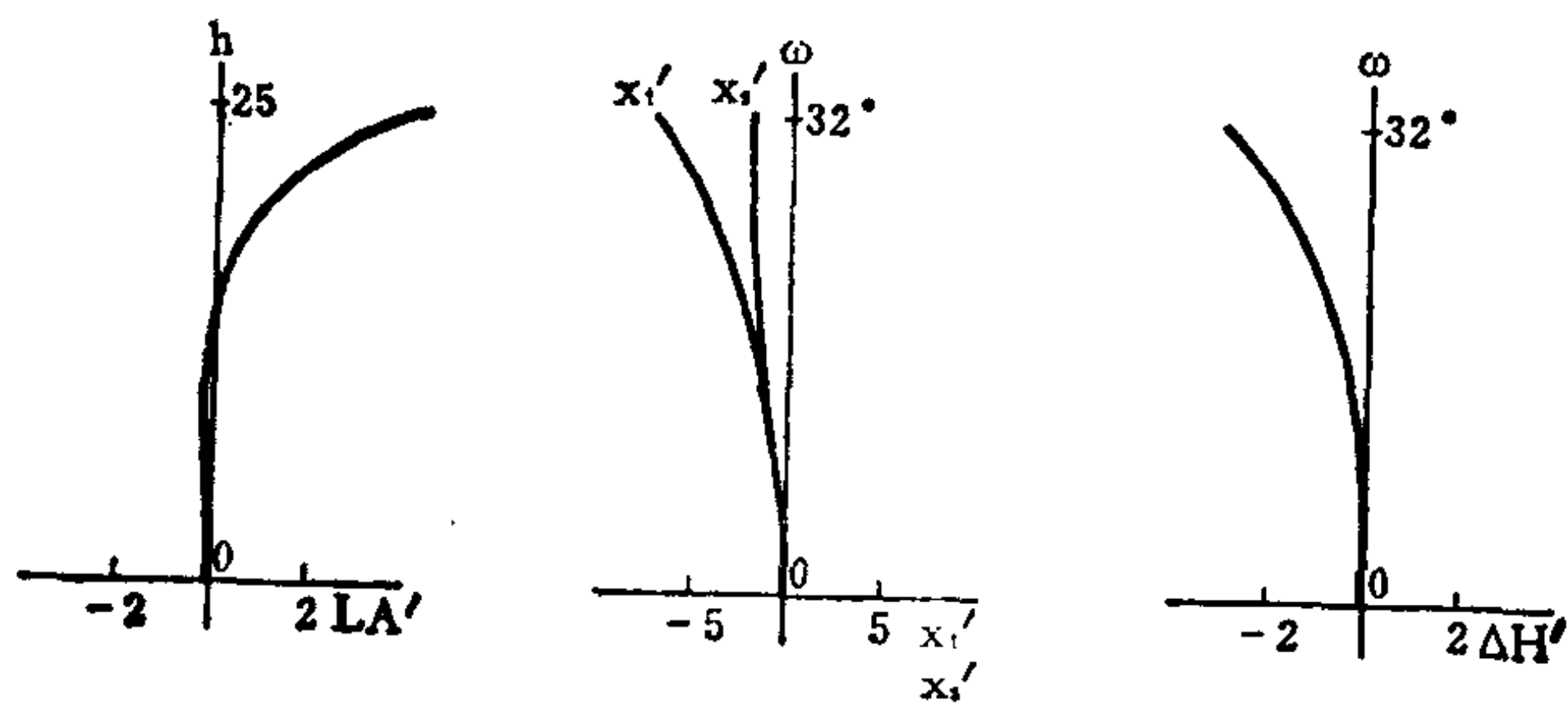

编号: 07-02-015

反远距型广角物镜

E. F. L = 100

B. F. L = 138.49

FNo. = 4

F. A. = $\pm 37.7^\circ$

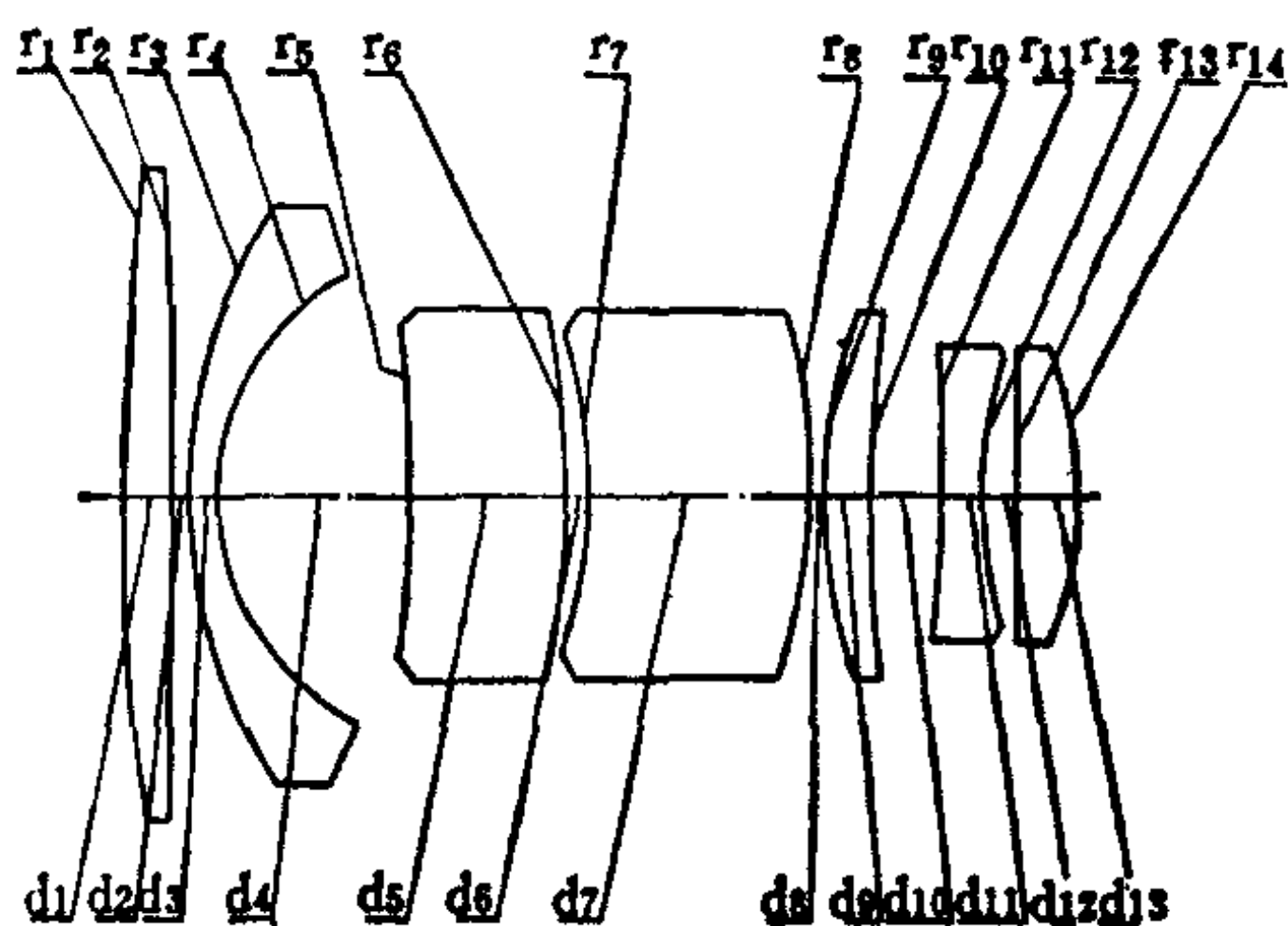

序号	r	d	n	v	序号	r	d	n	v
1	865.02	6.83	1.67003	47.3	8	-77.90	0.88		
2	-1424.08	1.05			9	67.11	6.78	1.72600	53.6
3	72.62	3.82	1.61800	63.4	10	238.28	10.35*		
4	35.36	27.33			11	-370.33	6.97	1.75520	27.5
5	-463.53	22.75	1.66892	45.0	12	70.66	2.75		
6	-114.16	2.67			13	∞	7.90	1.72600	53.6
7	-68.35	31.42	1.67790	55.3	14	-64.98			

10.35* = 5.00 + 5.35

	ΣS_1	ΣS_2	ΣS_3	ΣS_4	ΣS_5	HI	QP (1 ω)
	-0.030795	0.000143	0.000834	-0.049637	-0.555438	77.3	-2%
h 或 ω %	LA'	$\Delta H'$	x'_t	x'_s	$x'_t - x'_s$	K'_{T1}	$K'_{T0.7}$
100	-0.3315	-1.544	-0.999	0.195	-1.194	0.1366	0.0415
70	-0.3605	-0.882	-0.606	-0.576	-0.030	0.0157	-0.0085

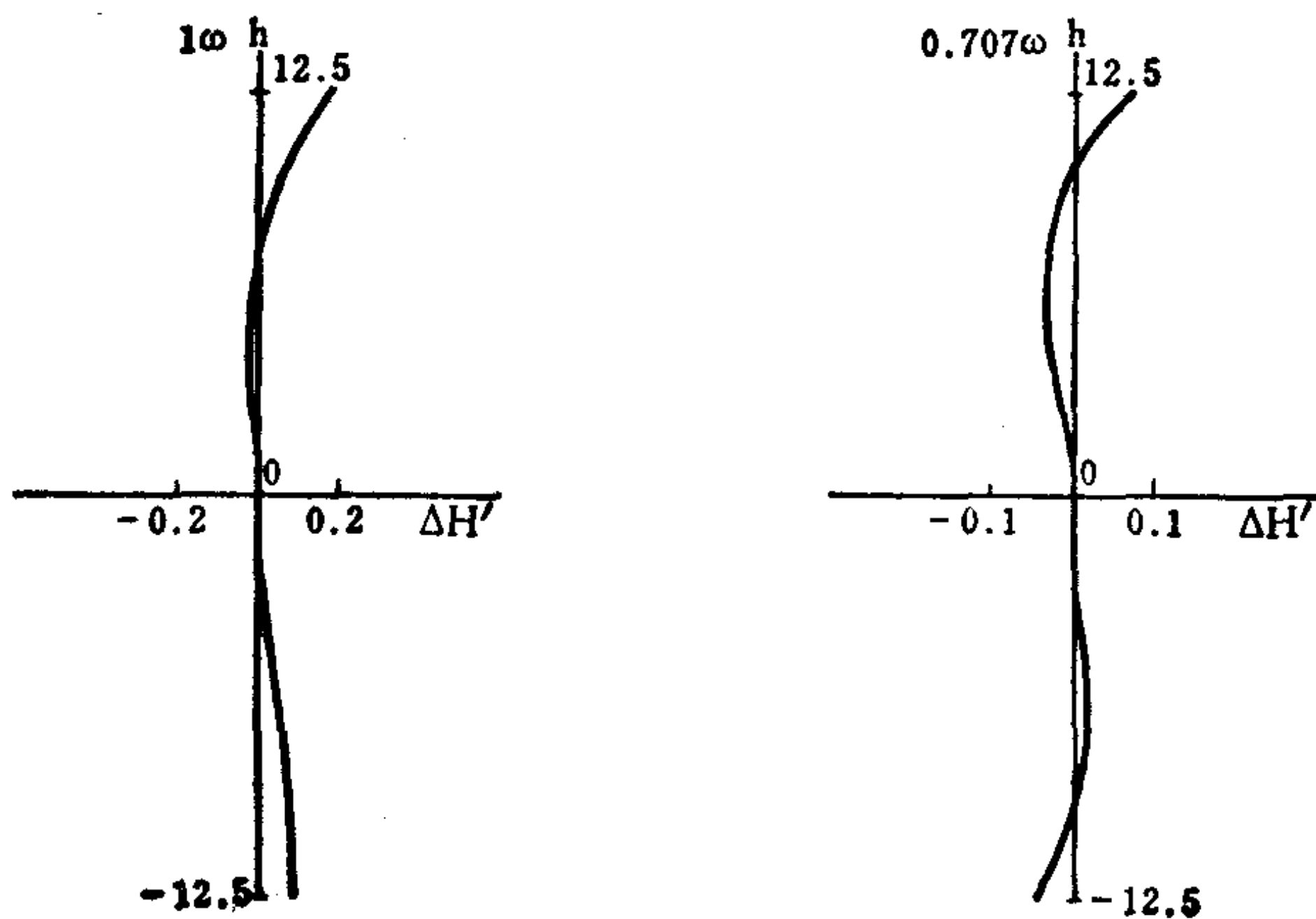
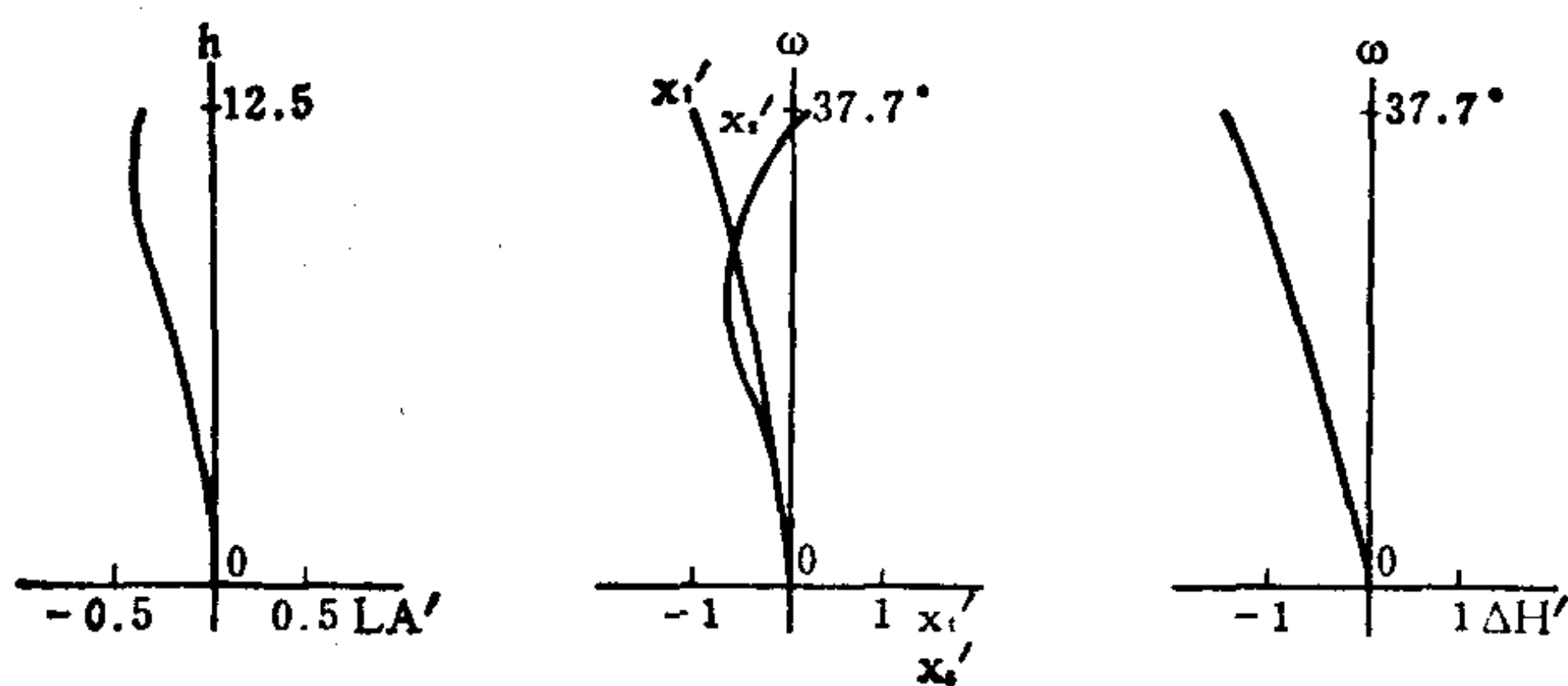

编号: 07-02-016

超广角大孔径物镜

E. F. L = 102.1

B. F. L = 200.3

FNo. = 2.86

F. A. = ± 50.36°

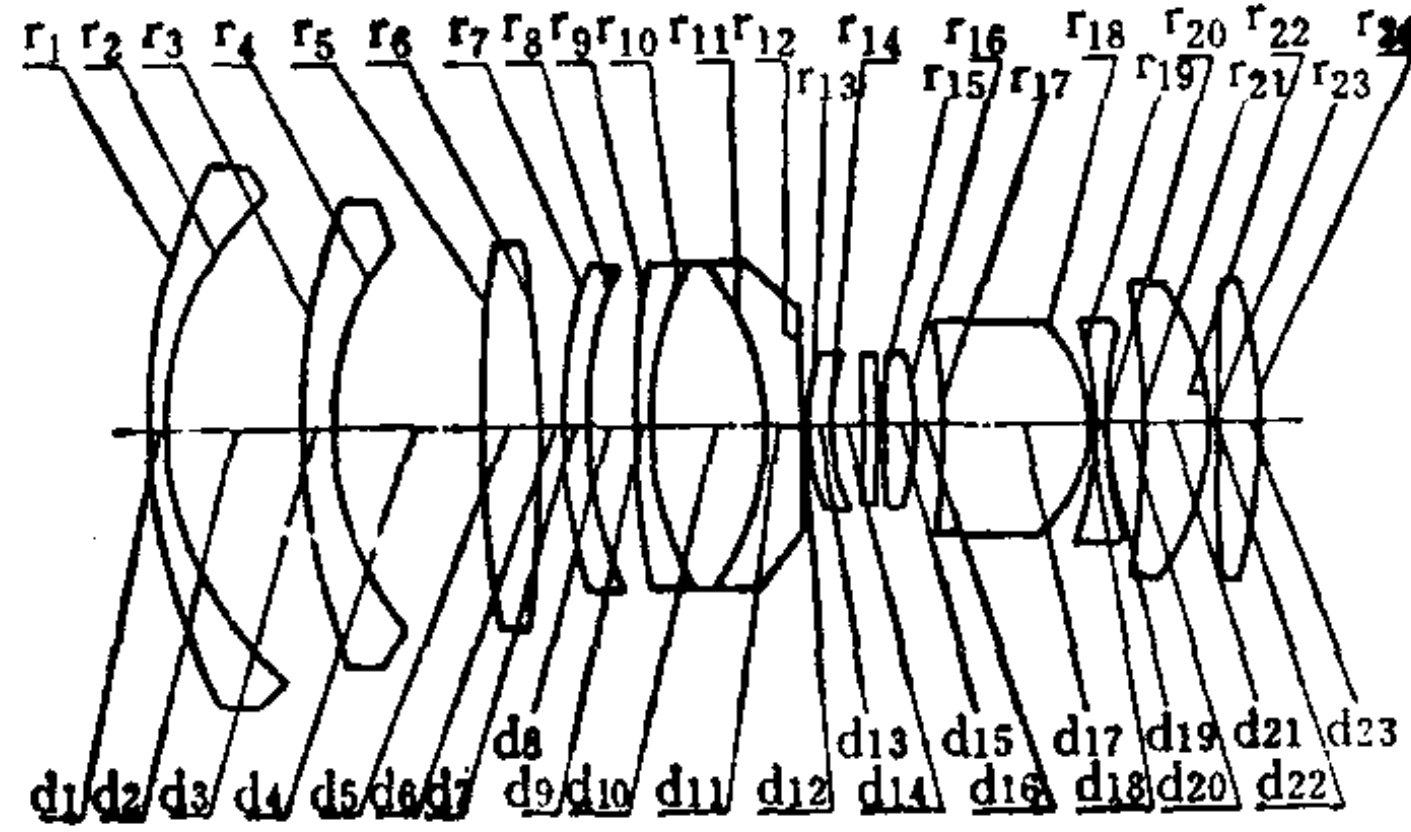

序号	r	d	n	v	序号	r	d	n	v
1	256.3	6.5	1.6031	60.7	14	47.6	20.5*		
2	121.6	47.4				∞			滤色片
3	253.9	14.1	1.7410	52.7		∞			
4	125.8	57.4			15	455.8	10.3	1.8051	25.4
5	783.8	22.9	1.6258	35.7	16	-249.8	9.9		
6	-430.9	6.1			17	-834.6	57.2	1.4645	66.0
7	211.3	9.3	1.8160	46.8	18	-66.9	0.5		
8	119.7	16.4			19	-201.9	5.4	1.8051	25.4
9	277.8	8.1	1.5473	53.6	20	157.9	11.1		
10	119.3	43.2	1.7200	50.2	21	-1167.6	25.5	1.4645	66.0
11	-100.4	12.6	1.5613	45.2	22	-95.6	0.5		
12	5113.5	0.5			23	10629.3	18.9	1.6204	60.3
13	89.6	8.1	1.6968	56.5	24	-209.0			

20.5* = 13.0 + 7.5

	ΣS_1	ΣS_2	ΣS_3	ΣS_4	ΣS_5	HI	QP (1 ω)
	-0.0091	0.1701	0.1815	-0.3255	-1.6049	123.3	-2.9%
h 或 ω %	LA'	$\Delta H'$	x'_t	x'_s	$x'_t - x'_s$	K'_{T1}	$K'_{T0.7}$
100	11.569	-3.681	30.75	11.17	19.58	1.1061	0.7047
70	1.778	-2.367	4.315	-0.268	4.583	1.8436	0.9224

注: 1. 以上象差值计算时, 未考虑滤色片。
2. 滤色片的基底玻璃是K9, d = 4.3。

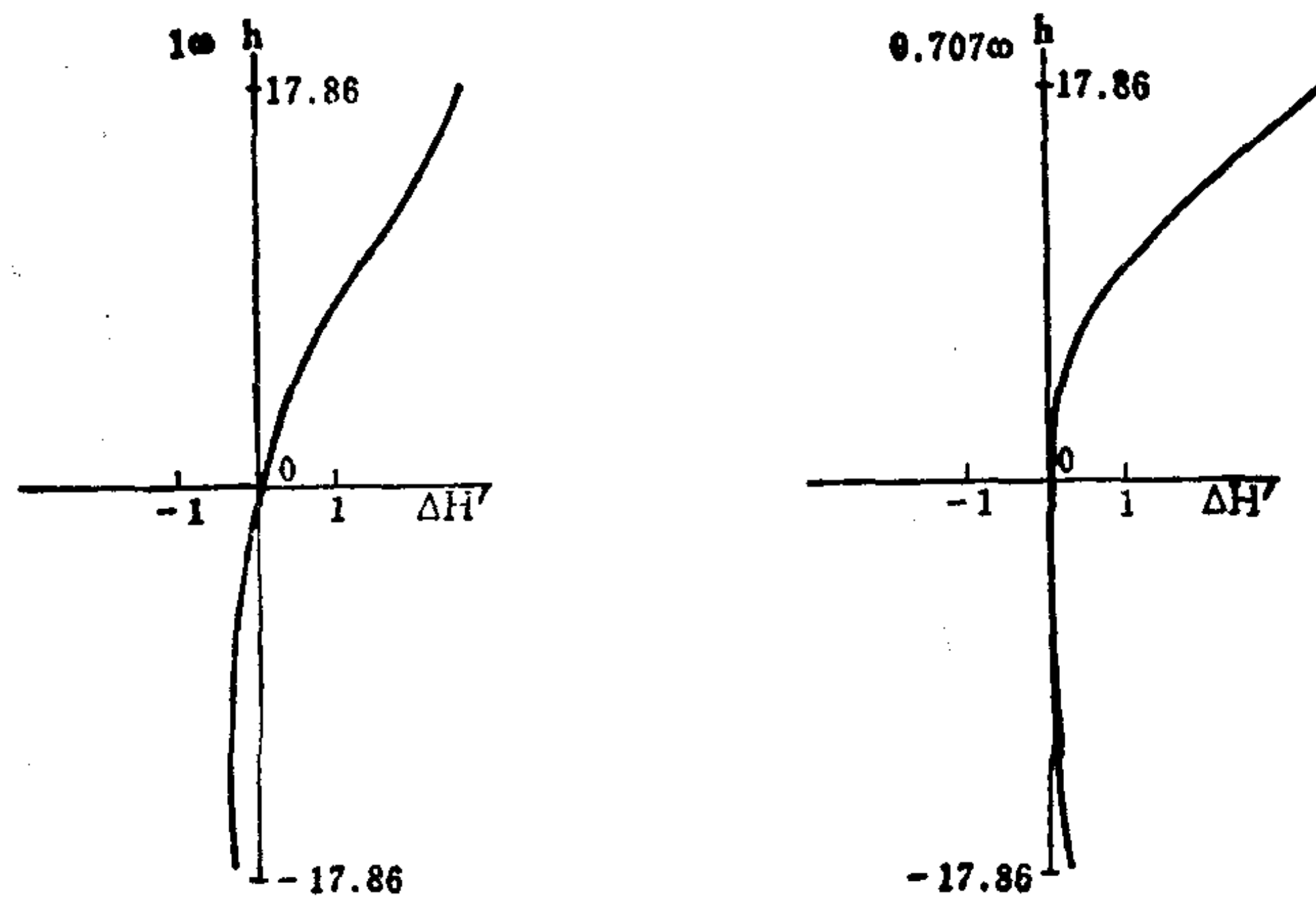
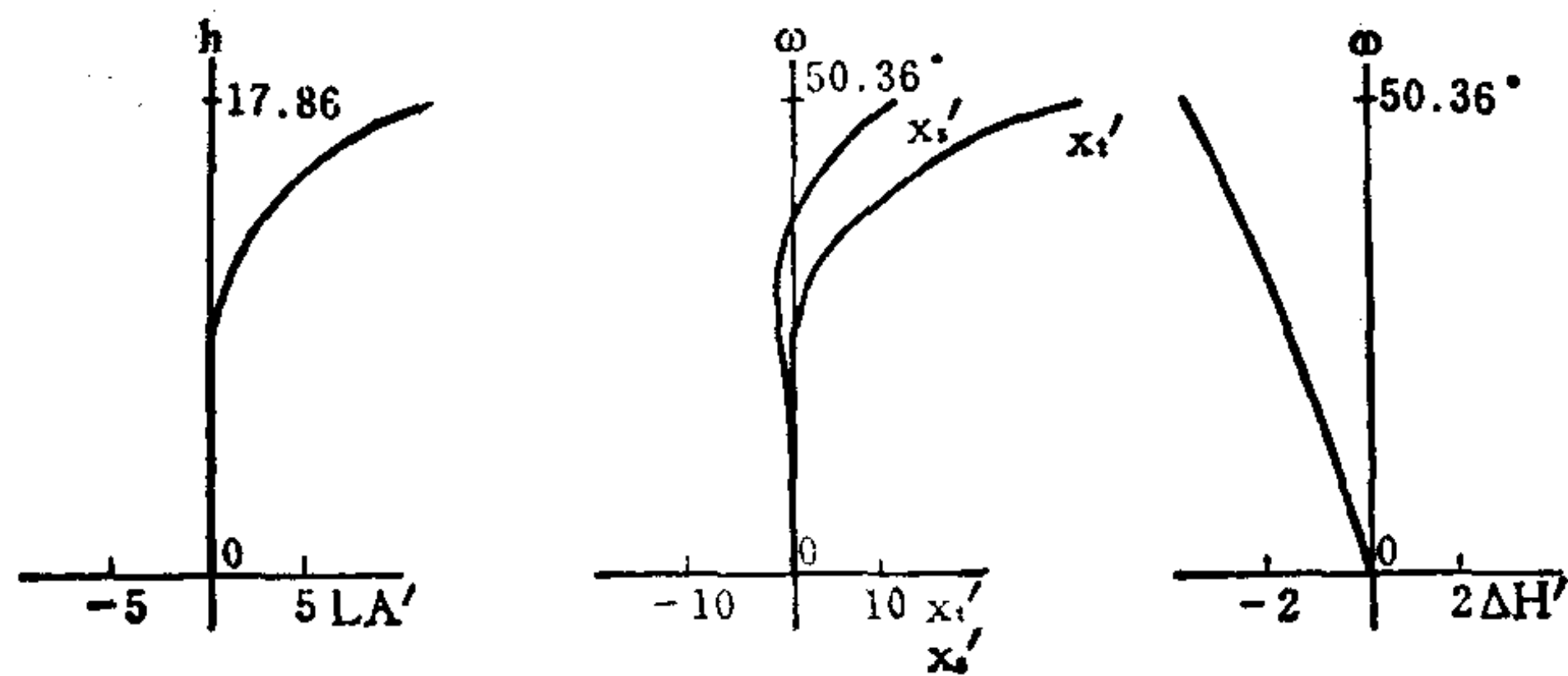

编号: 07-02-017

超广角大孔径物镜

E. F. L = 102.5

B. F. L = 203.1

FNo. = 2.87

F. A. = $\pm 50.3^\circ$

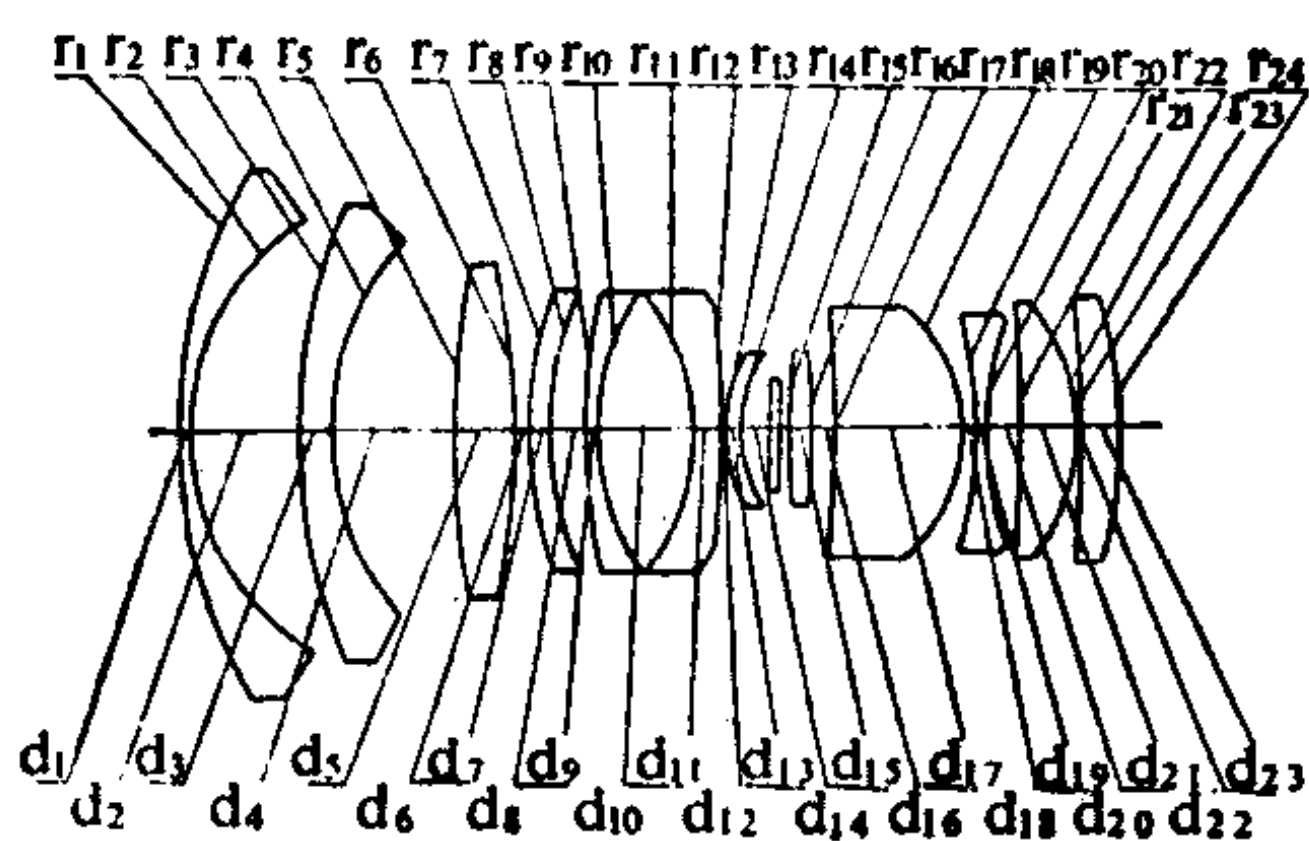

序号	r	d	n	v	序号	r	d	n	v
1	234.4	6.5	1.6031	60.7	14	47.5	16.9*		
2	115.9	48.9				∞			滤色片
3	281.5	14.1	1.7340	51.5		∞			
4	121.9	56.5			15	485.3	11.7	1.8051	25.4
5	600.7	27.6	1.6200	36.3	16	-264.1	9.9		
6	-416.3	7.1			17	-5686.1	62.1	1.4645	66.0
7	205.1	9.3	1.7995	42.2	18	-66.7	0.5		
8	129.4	14.5			19	-273.7	6.5	1.8051	25.4
9	280.4	8.1	1.5523	63.7	20	151.0	14.6		
10	111.9	42.1	1.7200	50.2	21	-725.0	23.4	1.4645	66.0
11	-101.4	12.6	1.5613	45.2	22	-100.0	0.5		
12	-13184.4	0.5			23	-3616.9	18.7	1.6204	60.3
13	102.0	6.4	1.7200	50.2	24	-200.9			

16.9* = 10.0 + 6.9

	ΣS_1	ΣS_2	ΣS_3	ΣS_4	ΣS_5	HI	QP (1ω)
	0.0364	0.1927	0.2090	-0.3152	-1.5401	123.5	-3%
h 或 $\omega\%$	LA'	$\Delta H'$	x'_t	x'_s	$x'_t - x'_s$	K'_{T1}	$K'_{T0.7}$
100	13.558	-3.779	41.89	12.88	29.01	0.4825	0.7149
70	2.328	-2.285	6.621	0.374	6.247	1.5711	1.0892

注: 1. 以上象差值计算时, 未考虑滤色片。
2. 滤色片的基底玻璃是K9, $d = 4.3$ 。

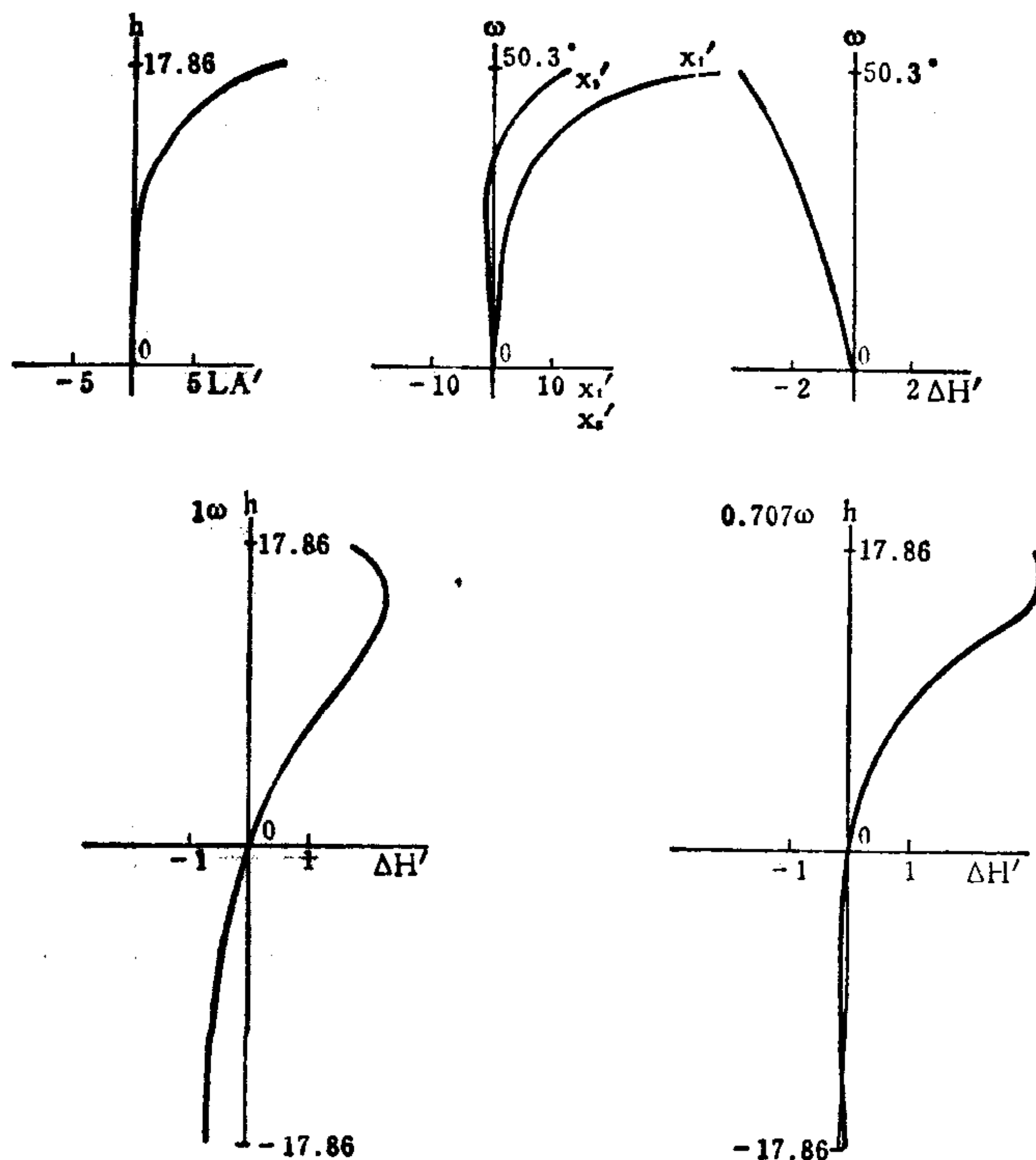

编号: 07-02-018

广角物镜

E. F. L = 100

B. F. L = 105.7

FNo. = 2.8

F. A. = $\pm 31.1^\circ$

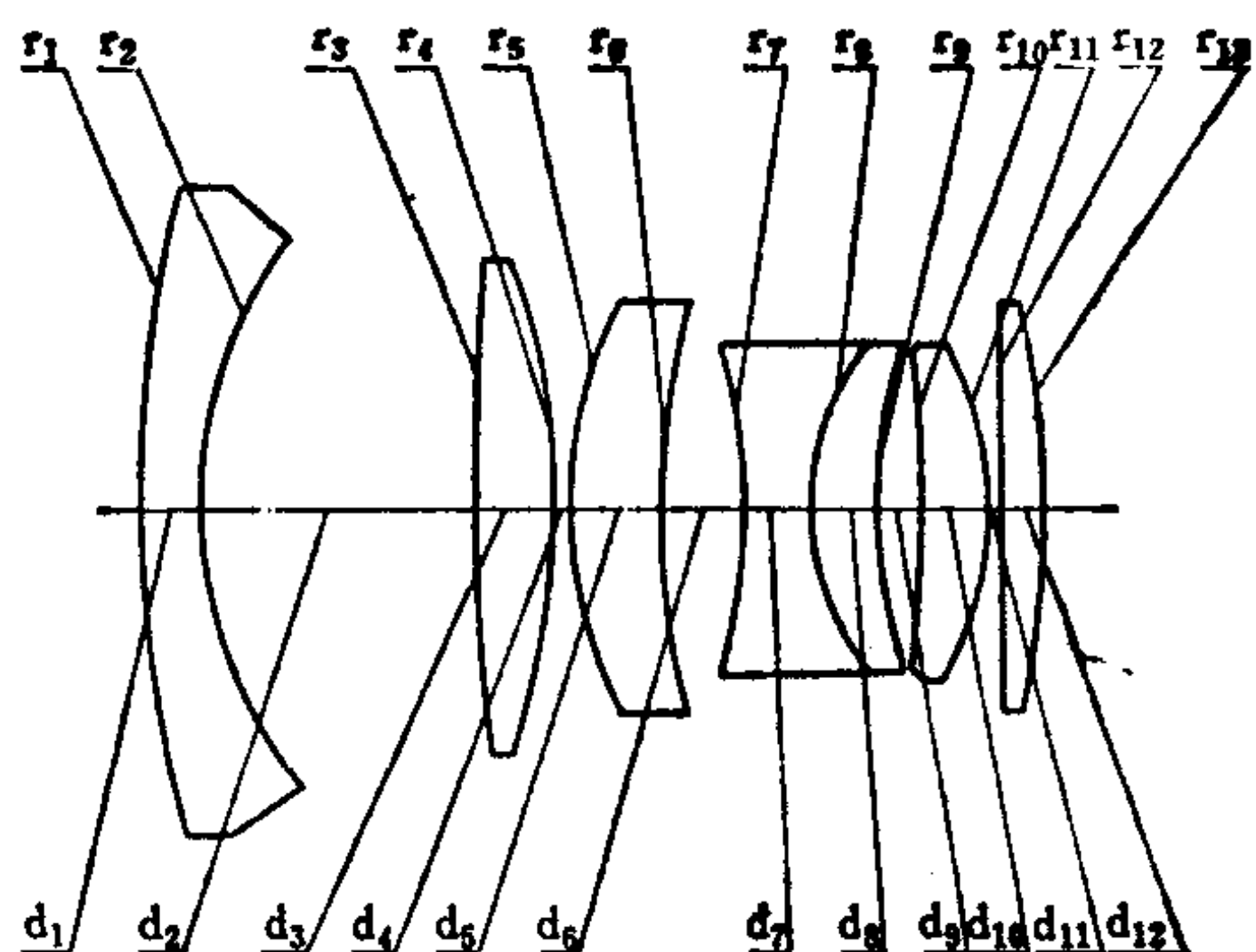

序号	r	d	n	v	序号	r	d	n	v
1	311.1	8.3	1.6425	58.4	8	56.5	10.2	1.6700	51.6
2	74.9	51.3			9	121.9	5.5		
3	1041.7	13.9	1.8061	40.8	10	-462.8	13.3	1.6935	50.8
4	-138.6	1.1			11	-67.1	0.6		
5	71.4	16.2	1.8044	39.6	12	4166.6	8.3	1.7440	44.8
6	127.6	14.7*			13	-175.0			
7	-108.3	14.3	1.7618	26.6					

14.7* = 7.7 + 7.0

	ΣS_1	ΣS_2	ΣS_3	ΣS_4	ΣS_5	HI	QP (1ω)
	-0.0369	-0.0270	0.0500	-0.2006	-0.3405	60.3	-0.3%
h 或 $\omega\%$	LA'	$\Delta H'$	x'_t	x'_s	$x'_t - x'_s$	K'_{T1}	$K'_{T0.7}$
100	0.0365	-0.1909	-3.511	-0.195	-3.316	0.2570	0.0633
70	-0.1668	-0.2765	-0.594	-0.843	0.249	0.1233	-0.0212

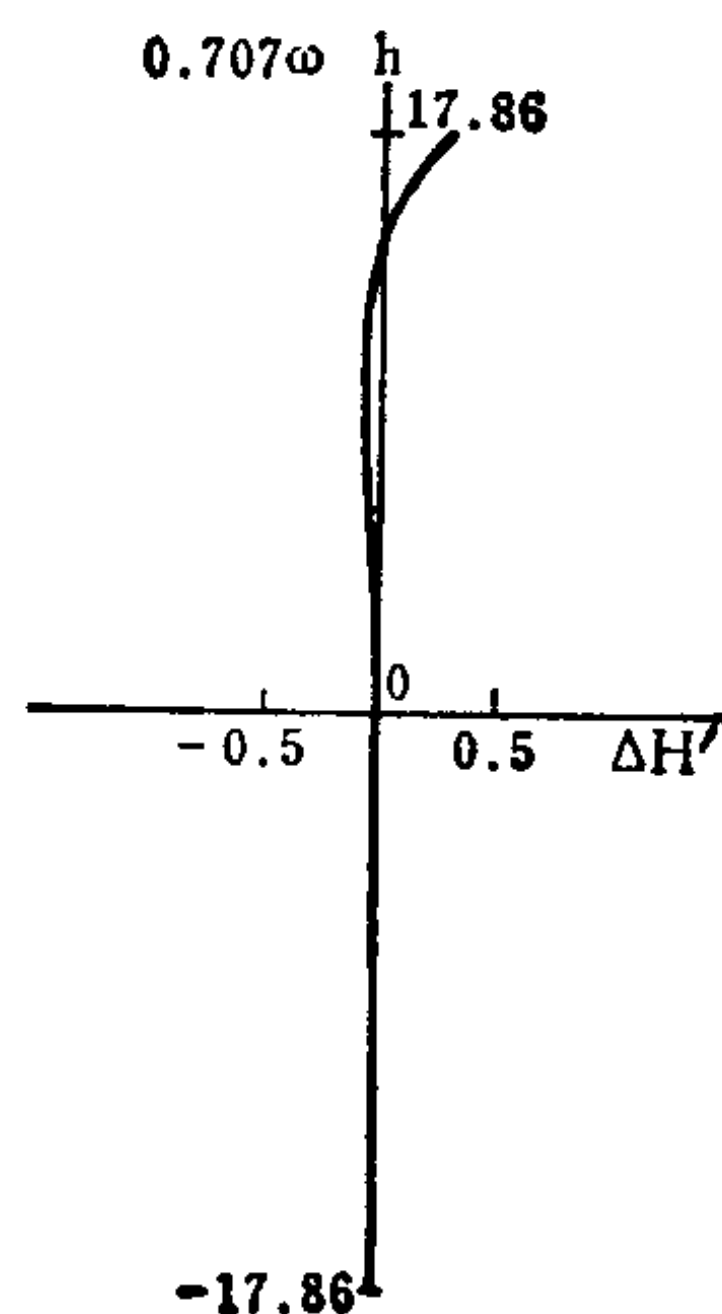
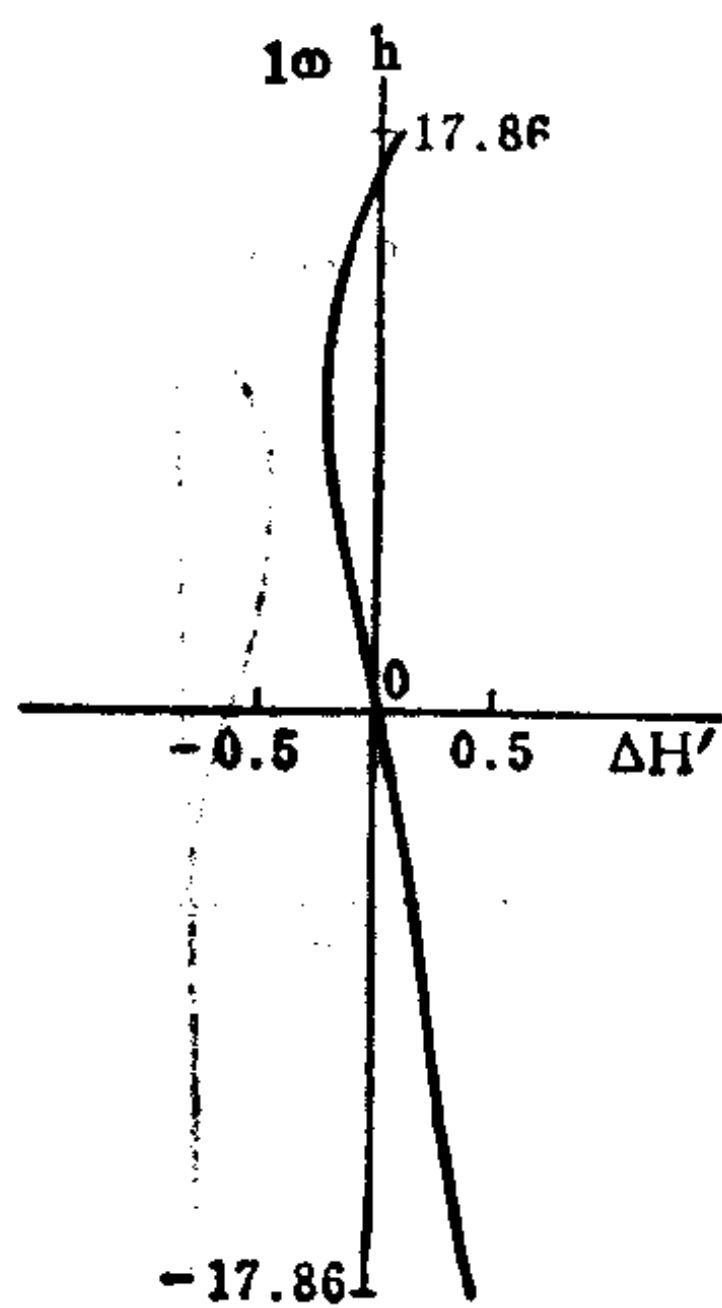
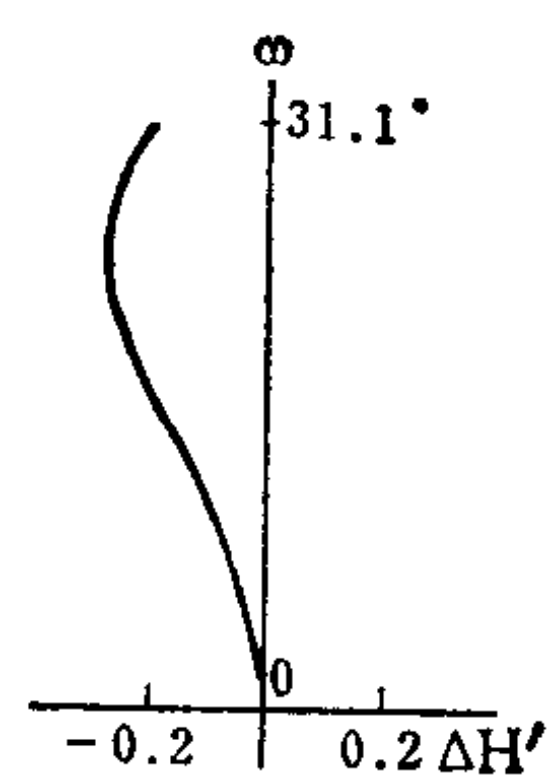
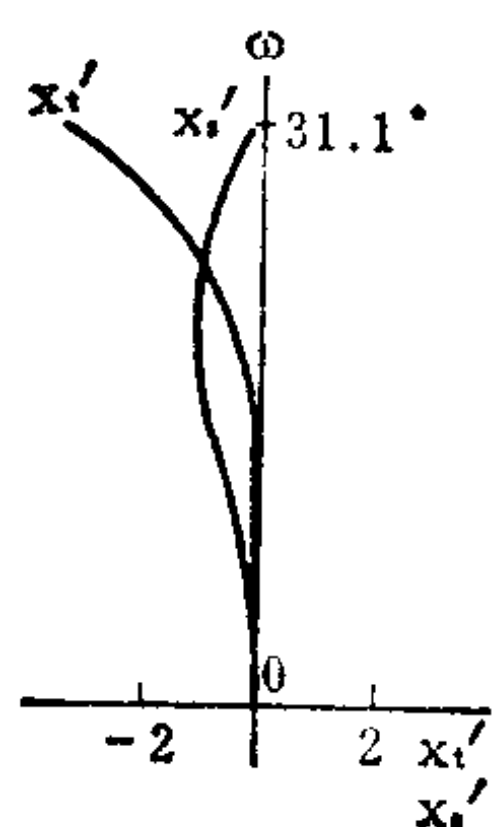
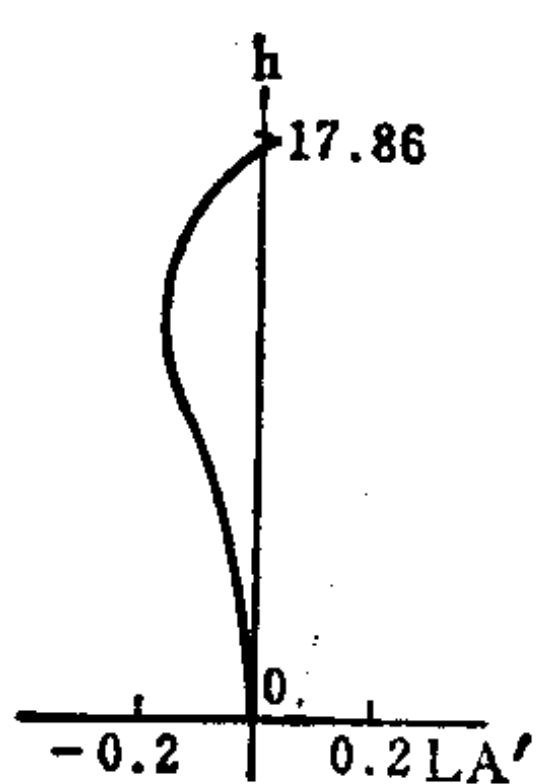

编号: 07-02-019

广 角 物 镜

E. F. L = 99.8

B. F. L = 103.4

FNo. = 2.8

F. A. = ± 31°

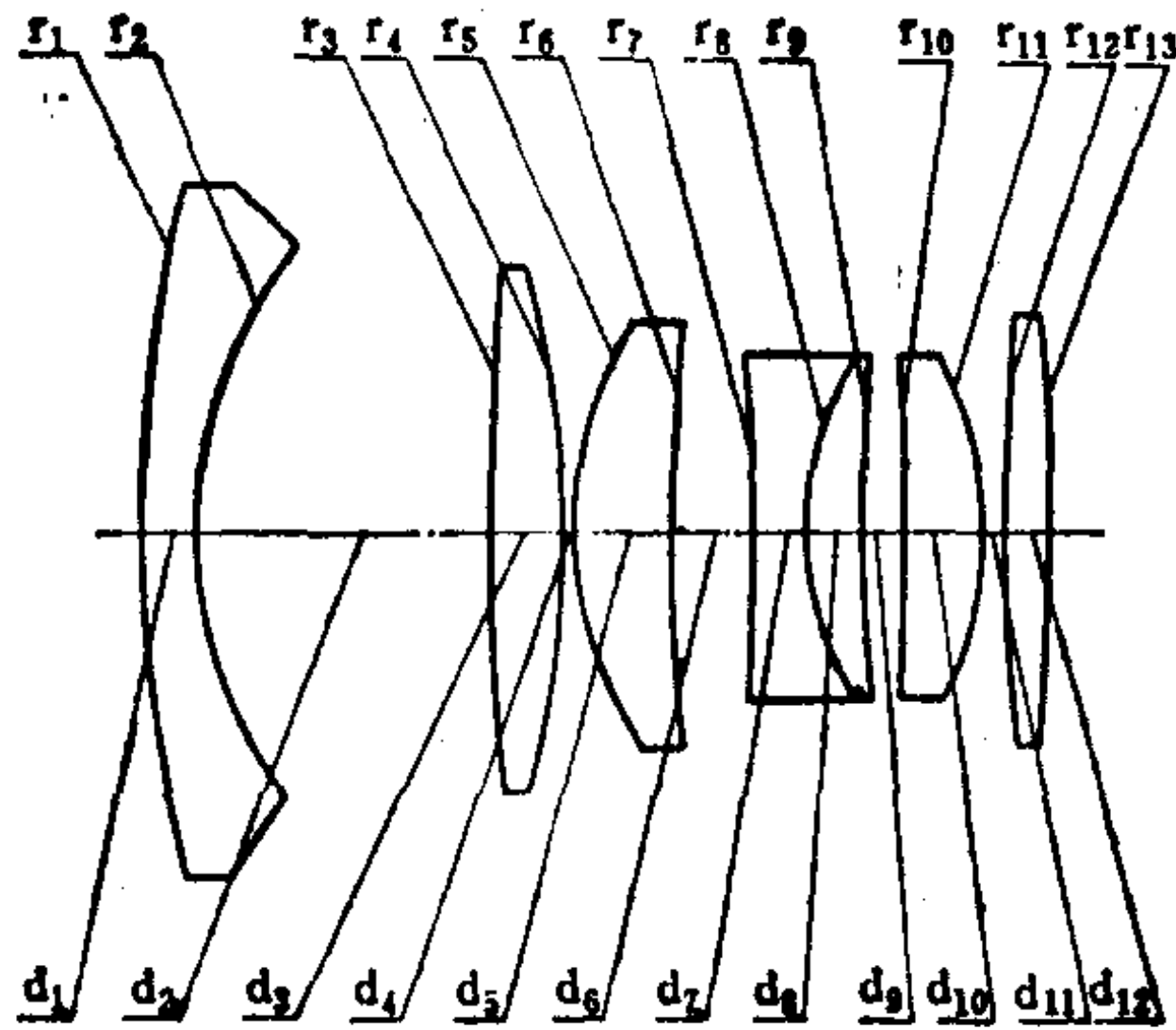

序号	r	d	n	v	序号	r	d	n	v
1	308.2	8.3	1.6425	58.4	8	55.7	10.9	1.6700	51.6
2	71.3	51.4			9	111.9	5.5		
3	754.2	13.9	1.8061	40.8	10	-644.8	12.8	1.6779	50.7
4	-139.5	1.0			11	-64.0	2.9		
5	65.5	16.8	1.8061	40.8	12	373.4	8.7	1.7725	49.6
6	102.4	14.8*			13	-386.3			
7	-112.9	9.7	1.7618	26.6					

14.8* = 7.7 + 7.1

	ΣS_1	ΣS_2	ΣS_3	ΣS_4	ΣS_5	HI	QP (1 ω)
	-0.0425	-0.0291	0.0344	-0.1722	-0.4302	59.9	-1.3%
h 或 ω %	LA'	$\Delta H'$	x'_t	x'_s	$x'_t - x'_s$	K'_{T1}	$K'_{T0.7}$
100	-0.0689	-0.7812	-1.269	0.364	-1.633	0.0708	0.0182
70	-0.2140	-0.4168	-0.369	-0.656	0.287	0.0276	-0.0392

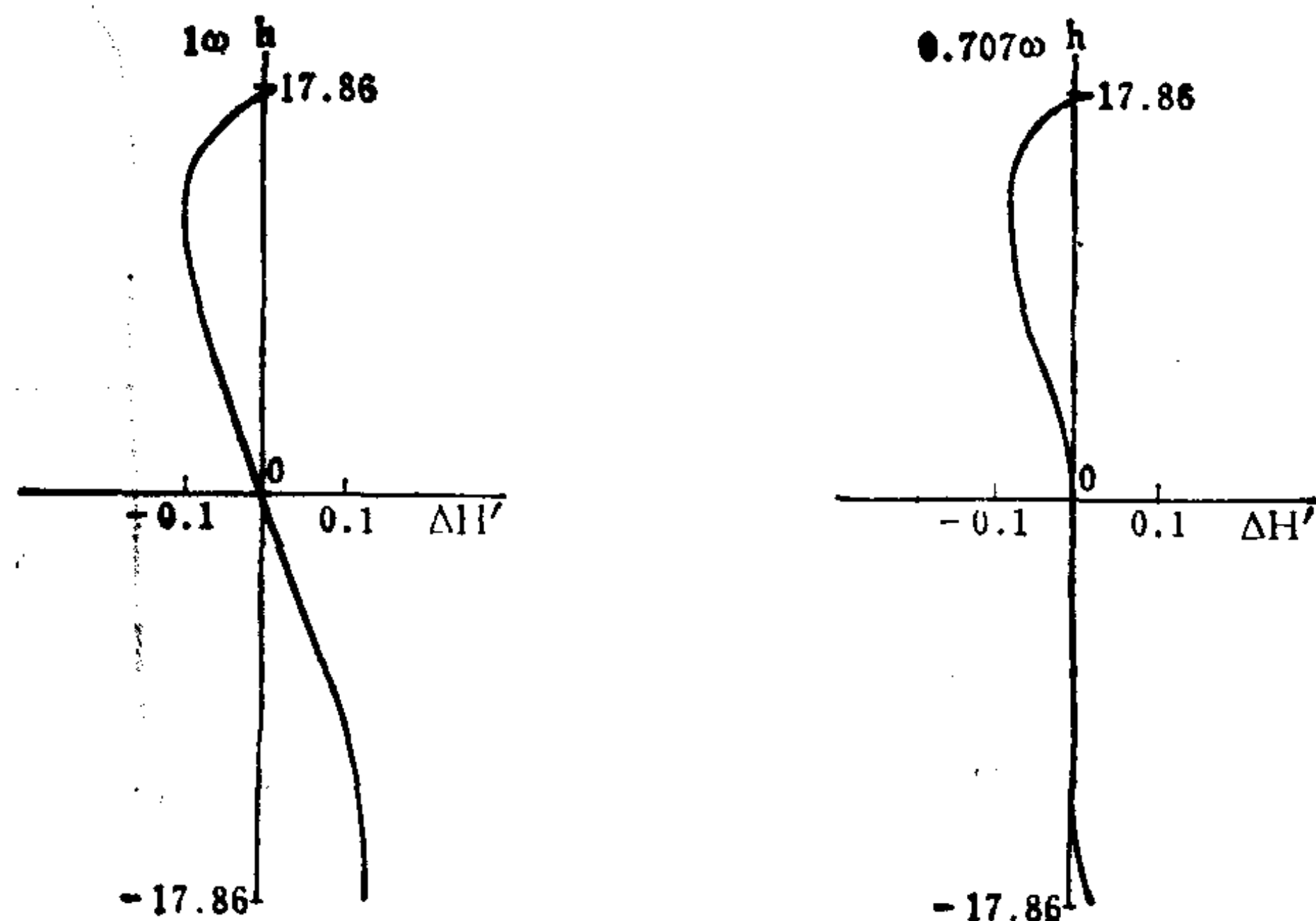
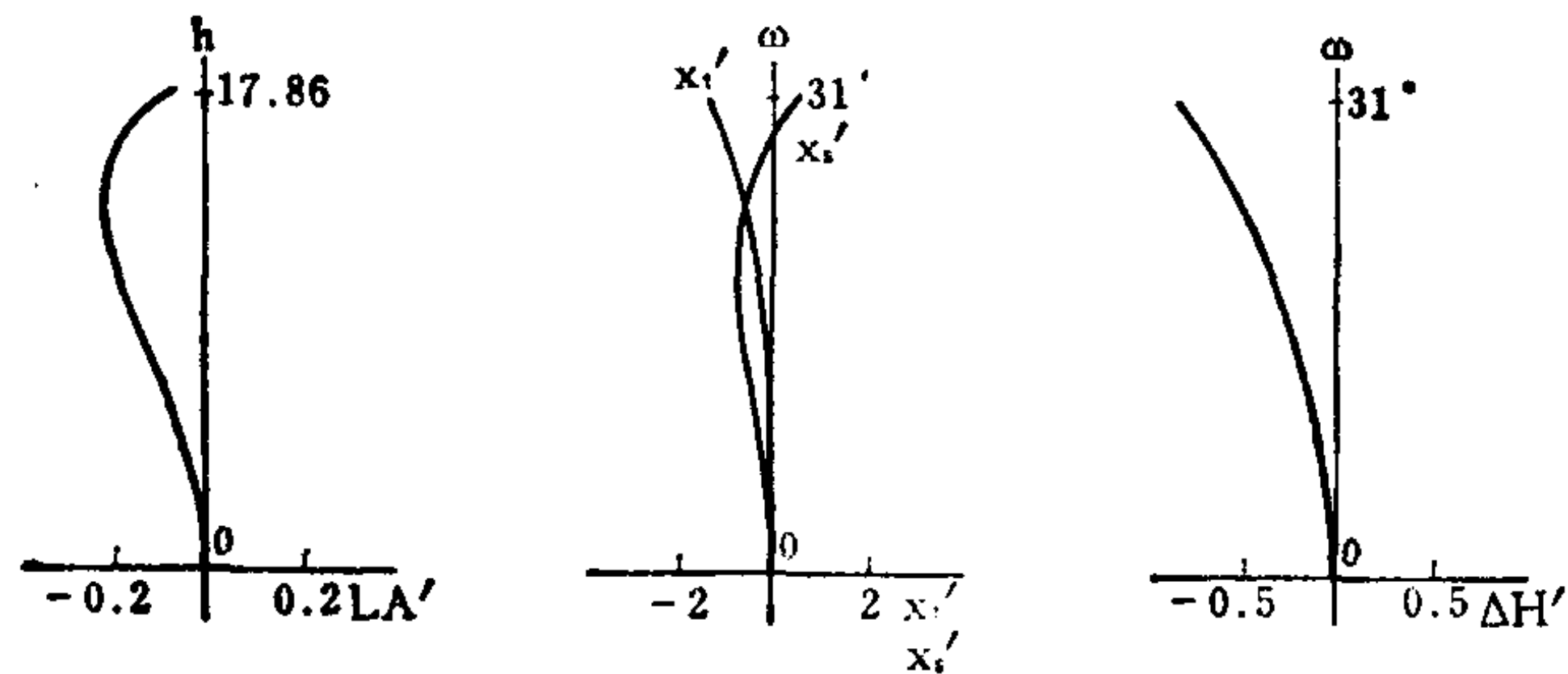

编号: 07-02-020

广 角 物 镜

E. F. L = 100

B. F. L = 166.5

FNo. = 2.8

F. A. = ± 42°

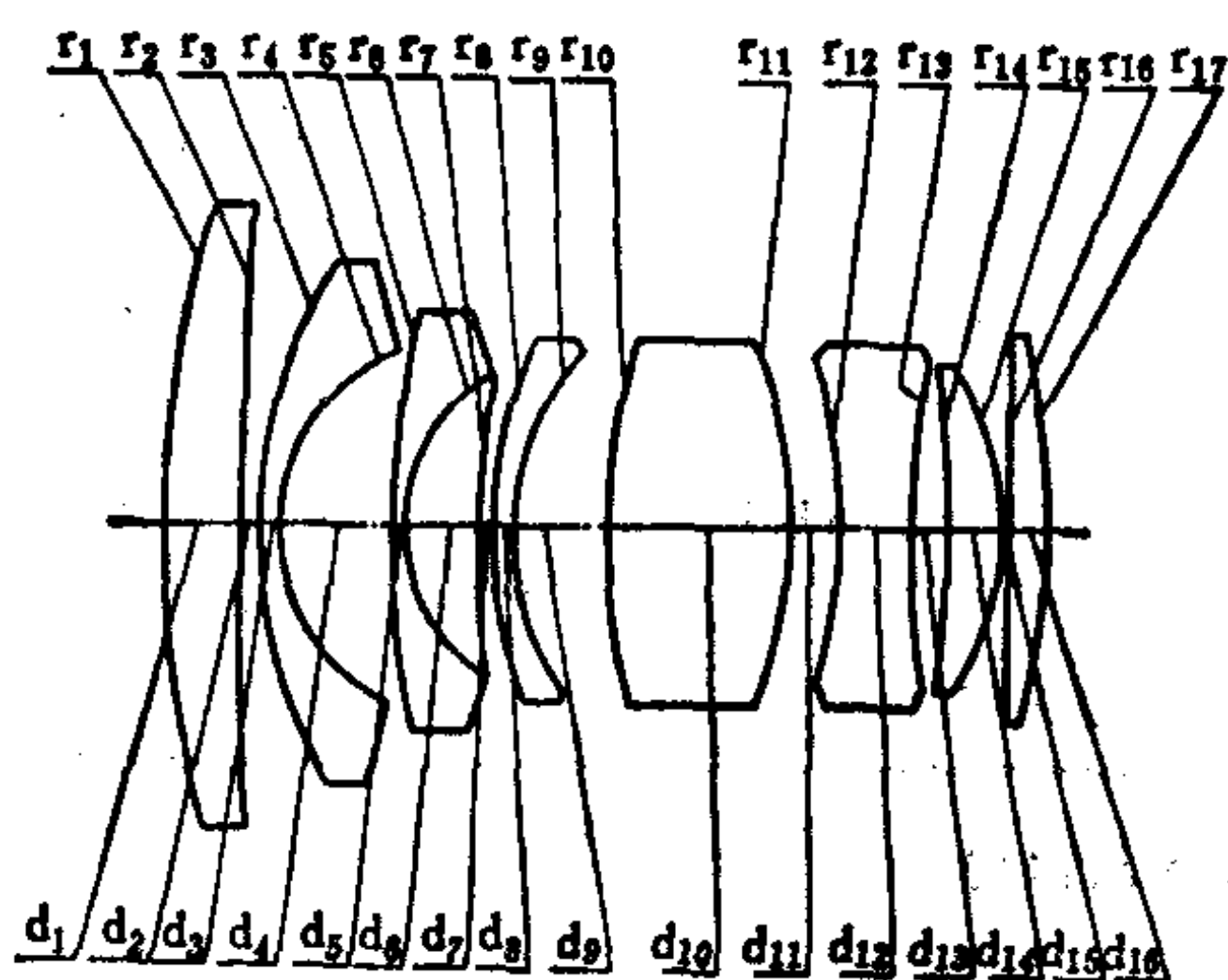

序号	r	d	n	v	序号	r	d	n	v
1	246.8	19.2	1.71300	54.0	10	113.5	43.2	1.7432	49.4
2	604.7	0.4			11	-91.2	10.7*		
3	103.5	6.1	1.62041	60.3	12	-126.2	16.0	1.80518	25.4
4	43.6	23.1			13	171.9	5.5		
5	183.0	4.1	1.78590	44.2	14	-563.0	14.3	1.52307	58.4
6	47.5	15.8	1.67270	32.1	15	-65.3	0.4		
7	172.8	2.0			16	34680.0	10.8	1.6968	55.7
8	111.4	5.3	1.6425	58.4	17	-146.9			
9	53.0	18.5							

10.7* = 5.0 + 5.7

	ΣS_1	ΣS_2	ΣS_3	ΣS_4	ΣS_5	HI	QP (1 ω)
	-0.1880	0.1907	-0.1375	-0.1549	-0.9945	90	-2.3%
h 或 ω %	LA'	$\Delta H'$	x_t'	x_s'	$x_t' - x_s'$	K_{T1}	$K_{T0.7}$
100	0.4666	-2.0733	-4.566	-0.437	-4.129	-0.4352	-0.1398
70	-0.7306	-1.3438	-1.253	-1.068	-0.185	-0.3883	-0.0362

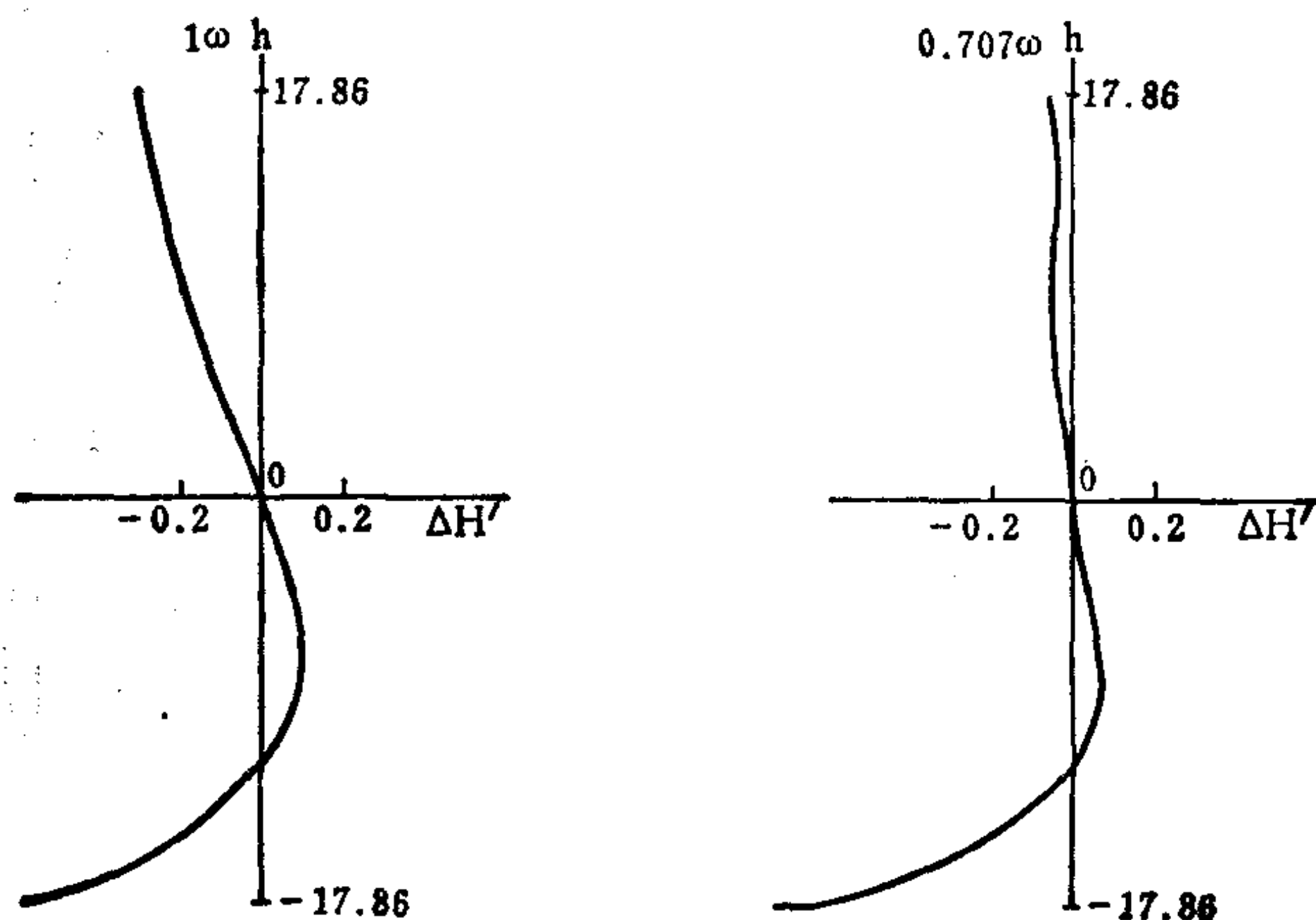
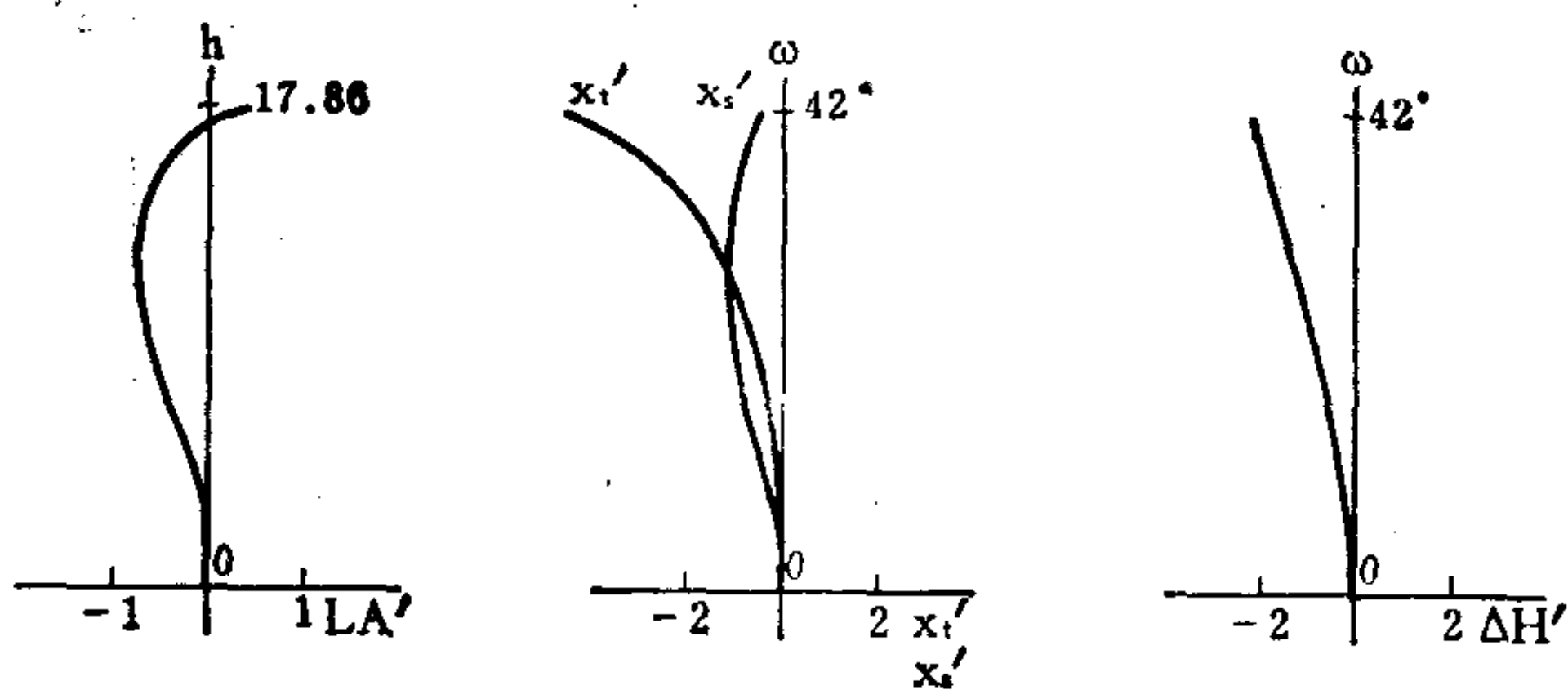

编号: 07-02-021

体积小的反远距型广角物镜

E.F.L = 100

B.F.L = 134.05

FNo. = 3.5

F.A. = ± 38°

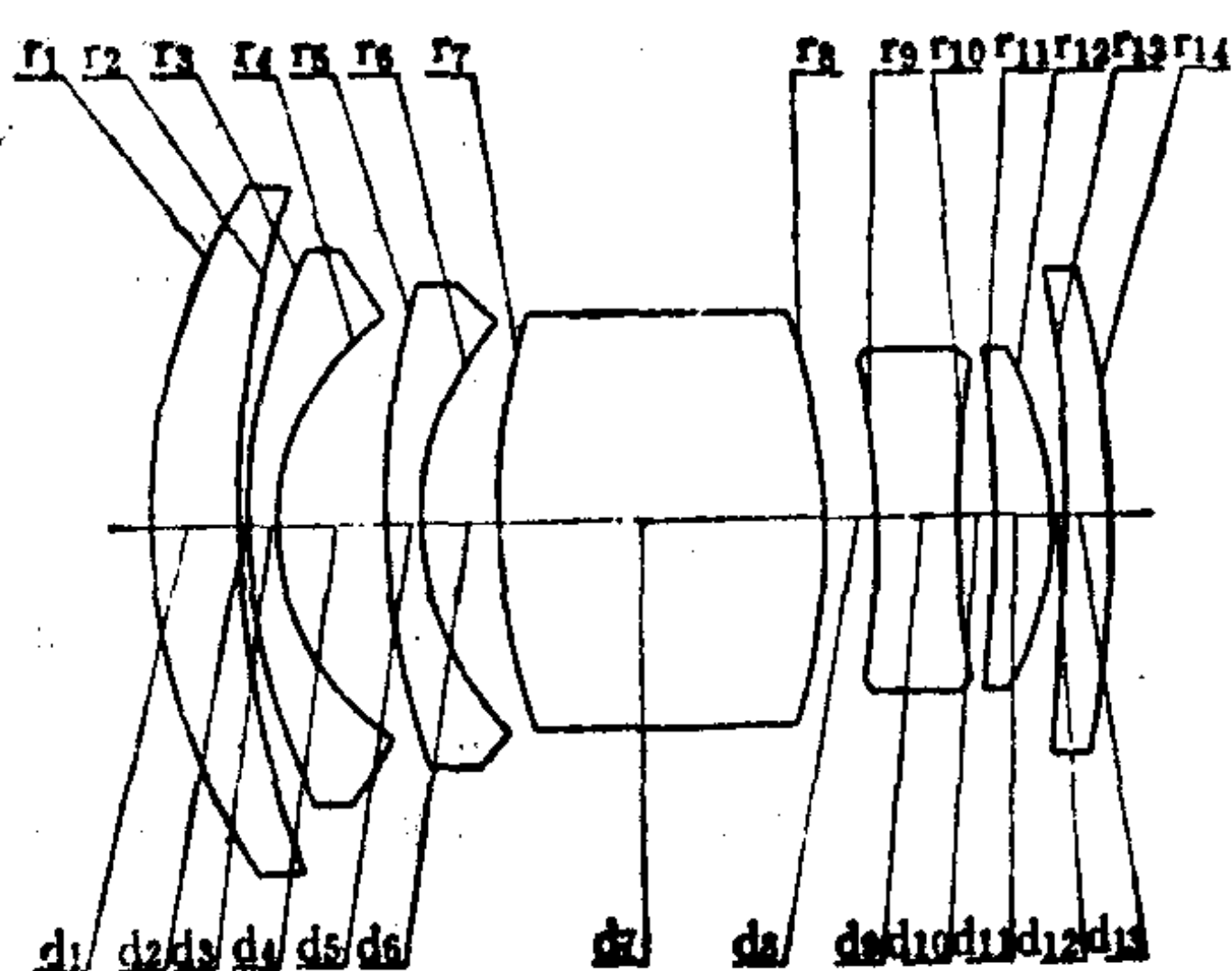

序号	r	d	n	v	序号	r	d	n	v
1	87.306	14.2800	1.72000	42.08	8	-73.327	7.1410*		
2	162.911	0.3570			9	-76.694	10.9260	1.76180	27.11
3	97.551	5.3560	1.58913	61.11	10	230.504	4.6060		
4	36.310	14.6000			11	-143.783	8.9270	1.69680	55.62
5	114.111	5.3560	1.58913	61.11	12	-50.050	0.5360		
6	39.524	11.2830			13	-1724.112	7.8550	1.56873	63.16
7	78.687	48.7750	1.67790	53.36	14	-113.904			

7.1410* = 3.0000 + 4.1410

	ΣS_1	ΣS_2	ΣS_3	ΣS_4	ΣS_5	HI	QP (1 ω)
	-0.06559	0.02544	-0.00099	-0.08790	-0.37709	78.1	-1.3%
h 或 ω %	LA'	$\Delta H'$	x'_i	x'_s	$x'_i - x'_s$	K'_{T1}	$K'_{T0.7}$
100	-0.2056	-1.008	-1.749	-0.408	-1.341	-0.10202	0.00940
70	-0.5173	-0.536	-0.732	-0.849	0.117	-0.11355	-0.01558

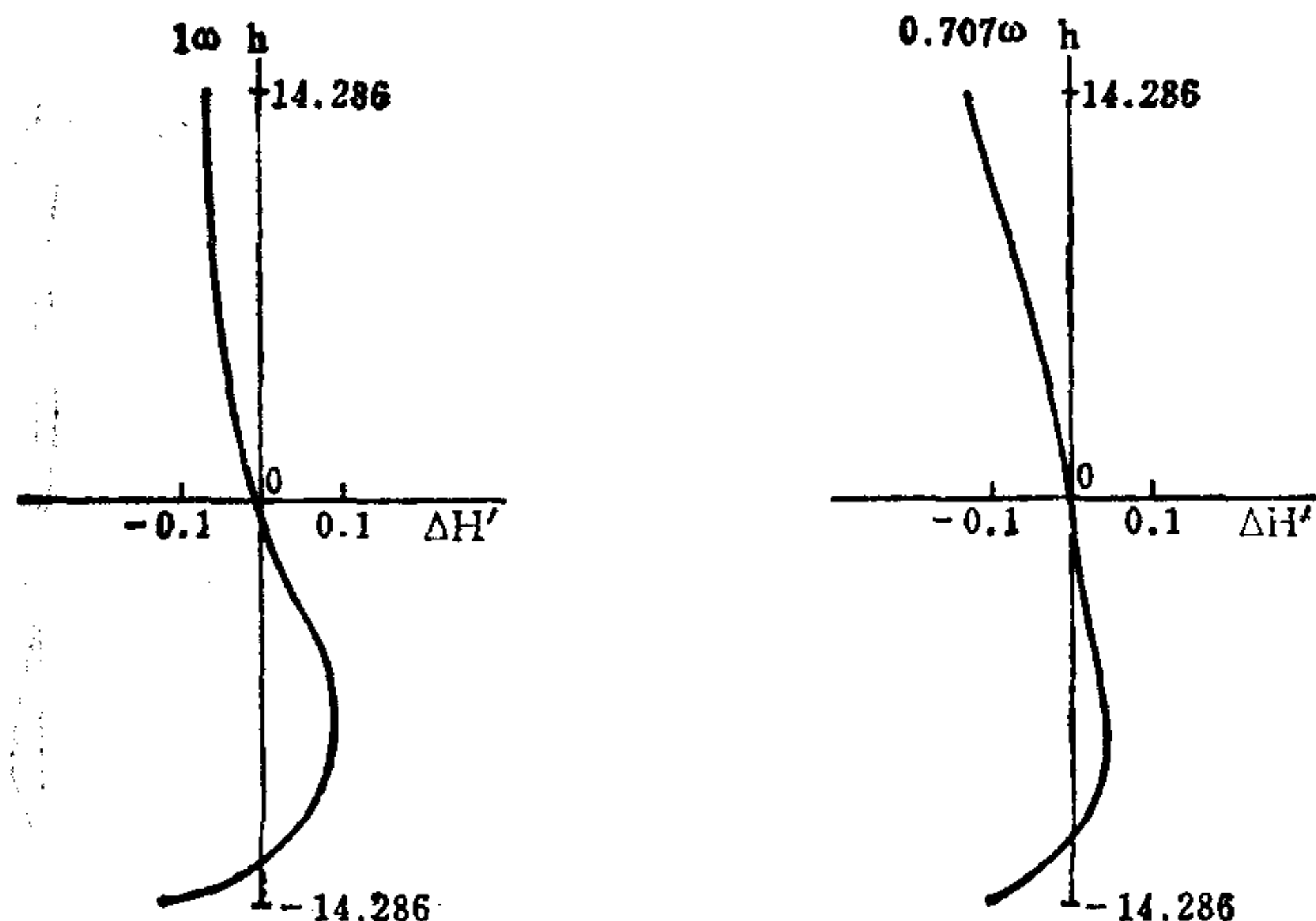
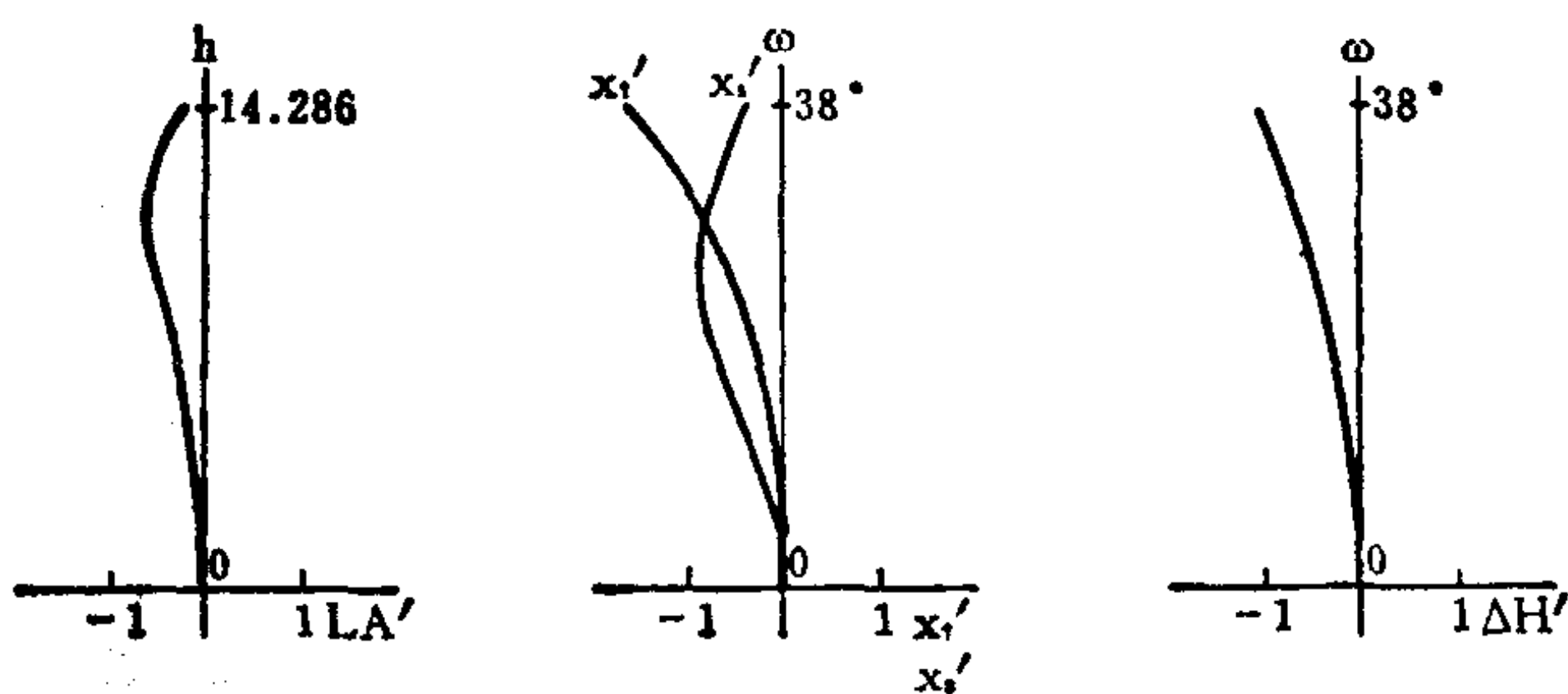

编号: 07-02-022

体积小的反远距型广角物镜

E.F.L = 100

B.F.L = 133.96

FNo. = 3.5

F.A. = ± 38°

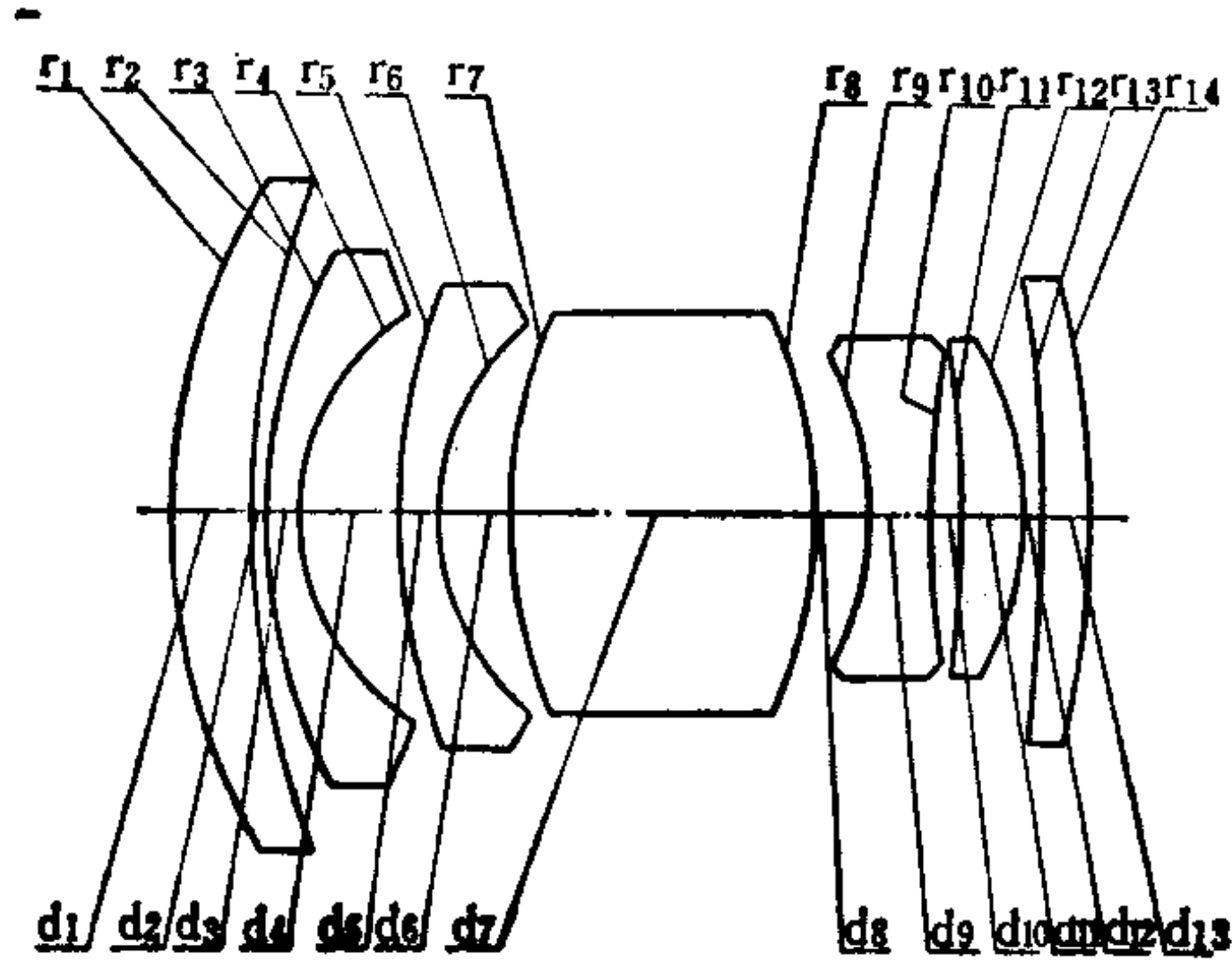

序号	r	d	n	v	序号	r	d	n	v
1	96.475	14.29	1.73520	41.08	8	-72.651	7.14*		
2	160.012	0.36			9	-74.912	10.93	1.72825	28.46
3	85.458	5.36	1.50378	66.81	10	193.104	4.61		
4	35.556	14.61			11	-170.430	8.93	1.64000	60.26
5	109.514	5.36	1.64000	60.25	12	-46.484	0.54		
6	37.124	11.29			13	-943.009	7.86	1.56873	63.16
7	76.508	44.46	1.67790	53.36	14	-117.467			

7.14* = 3.00 + 4.14

	ΣS_1	ΣS_2	ΣS_3	ΣS_4	ΣS_5	HI	QP (1 ω)
	-0.06872	0.01688	-0.00439	-0.08783	-0.36350	78.1	-1.27%
h 或 ω %	LA'	$\Delta H'$	x'_t	x'_s	$x'_t - x'_s$	K'_{T1}	$K'_{T0.7}$
100	-0.1063	-0.995	-2.178	-0.374	-1.804	-0.07689	0.03069
70	-0.5277	-0.523	-0.989	-0.916	-0.073	-0.13219	-0.02412

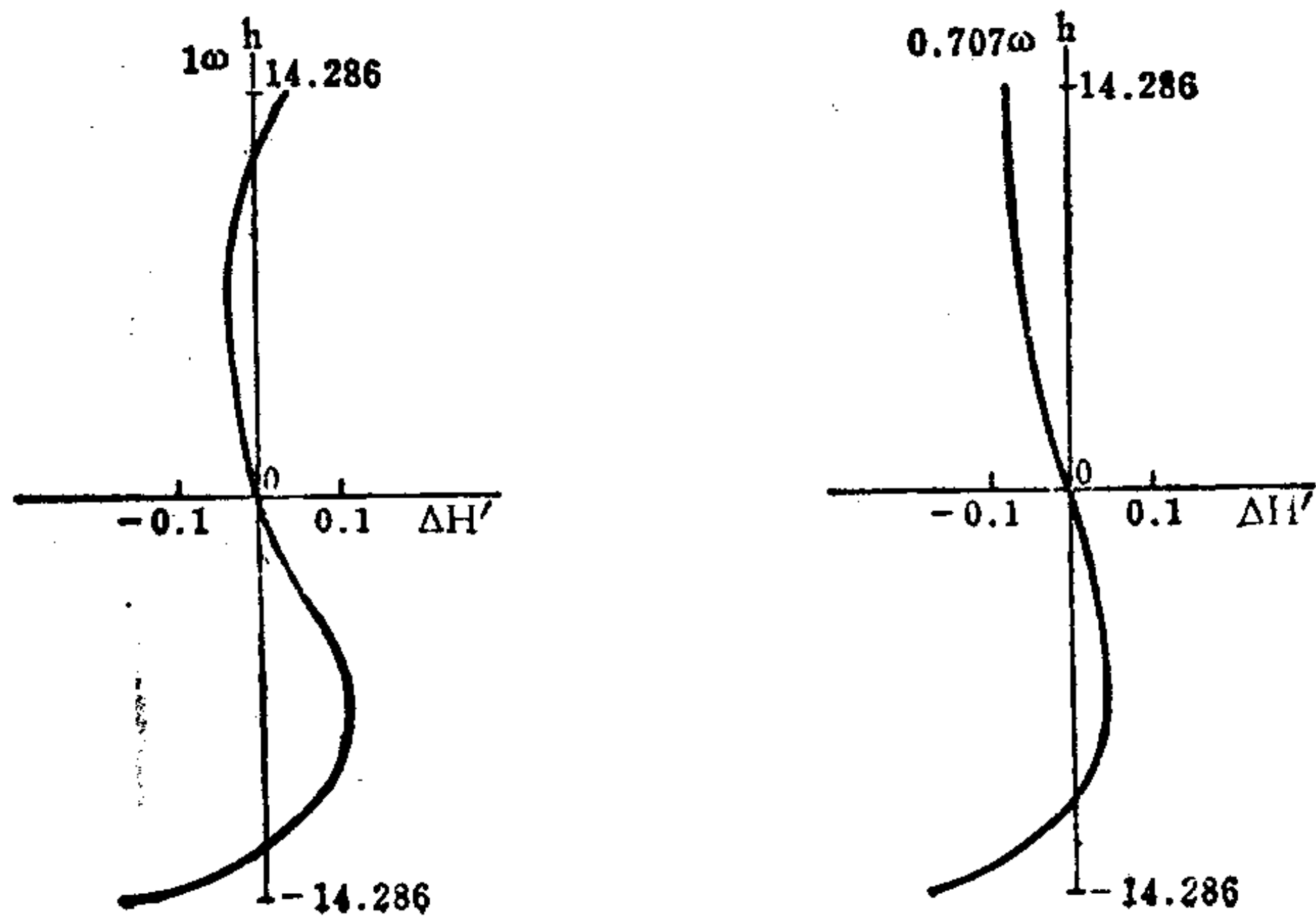
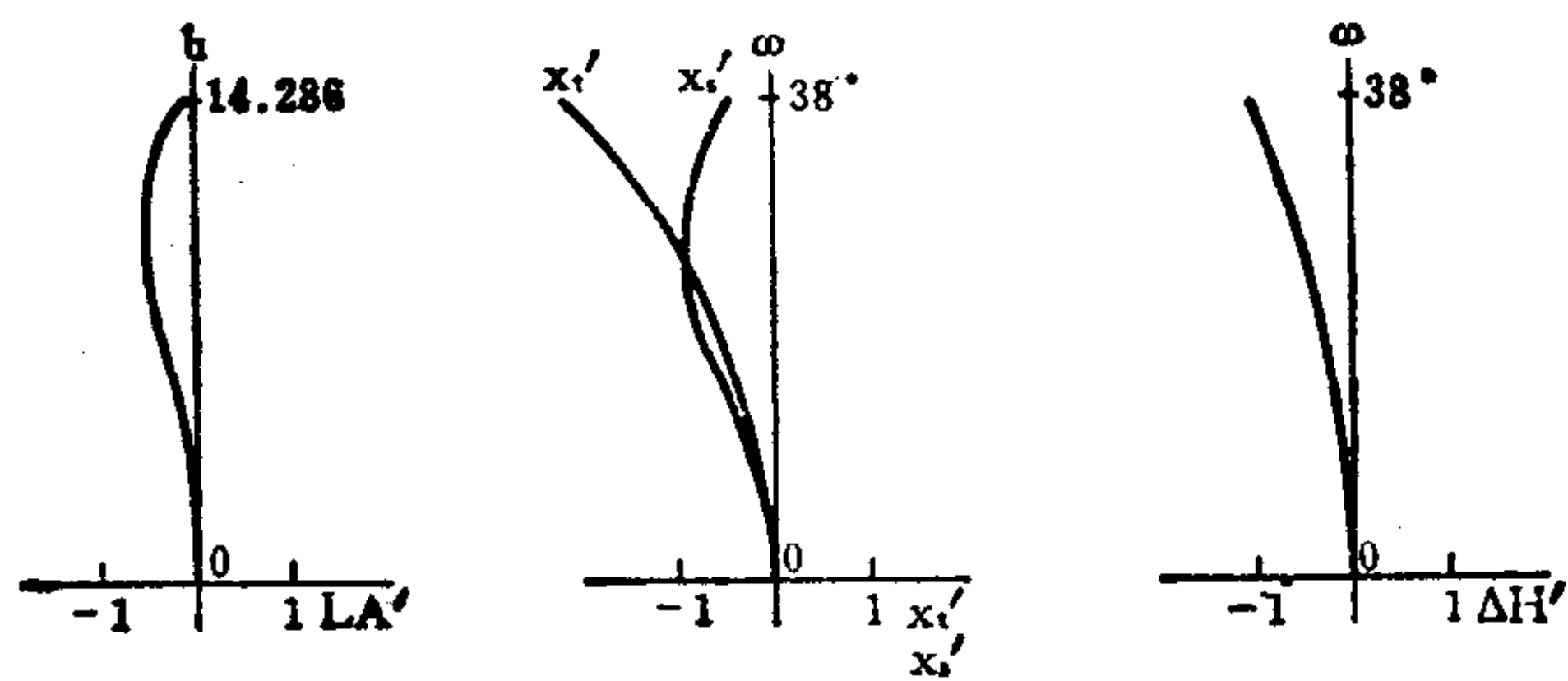

编号: 07-02-023

准广角大孔径物镜

E.F.L=99.4

B.F.L=94.9

FNo.=1.79

F.A.=±28.5°

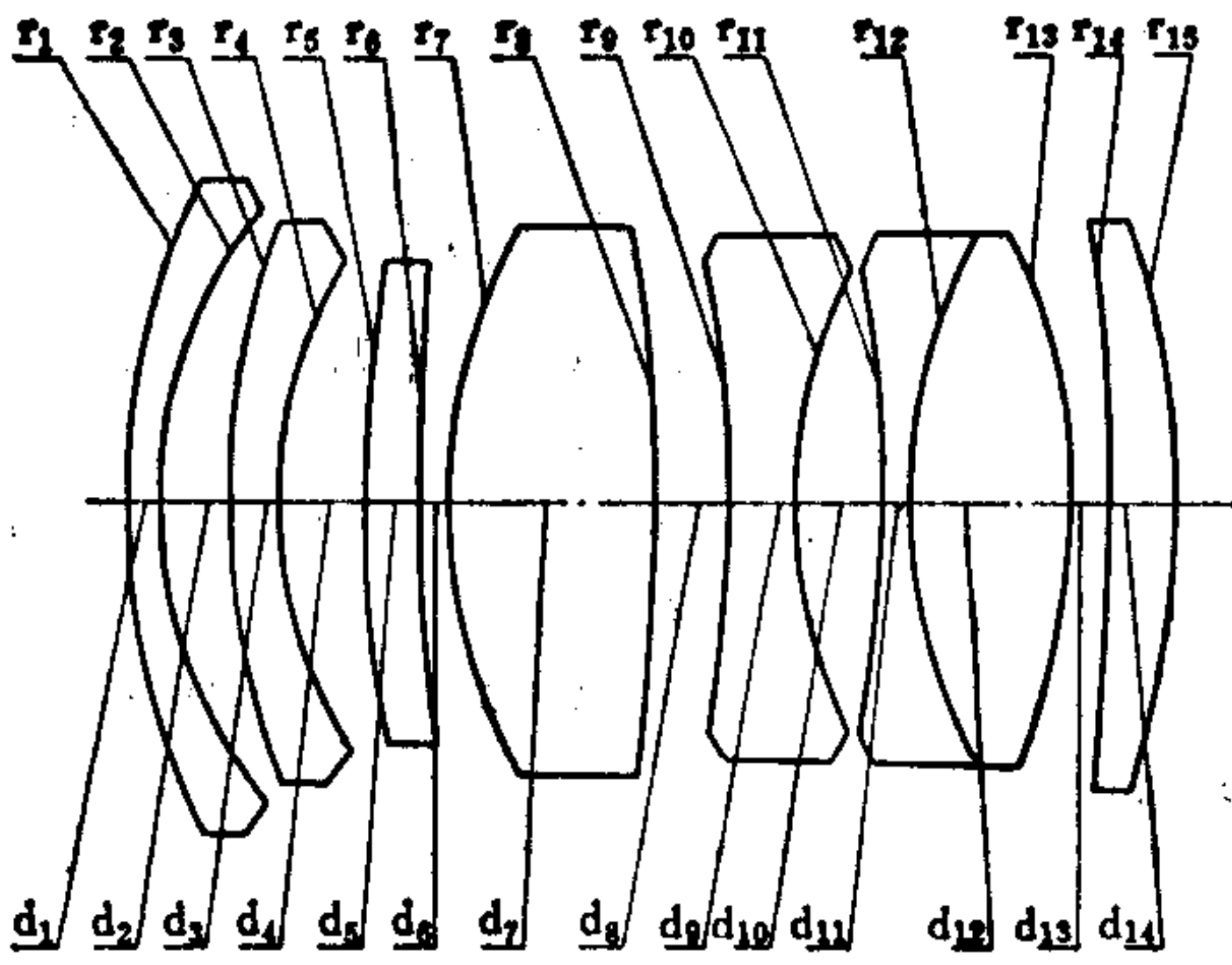

序号	r	d	n	v	序号	r	d	n	v
1	92.500	3.95	1.51633	64.1	9	-149.500	9.00	1.76182	26.6
2	57.275	9.52			10	68.250	9.67		
3	132.250	5.32	1.69350	53.3	11	-159.375	5.00	1.74077	27.8
4	55.875	9.42			12	80.750	19.20	1.80610	40.8
5	167.500	7.50	1.83400	37.2	13	-79.500	3.75		
6	1537.500	2.50			14	-951.448	8.75	1.78590	44.2
7	68.313	26.50	1.78590	44.2	15	-111.275			
8	-178.523	9.27*							

9.27* = 4.00 + 5.27

	ΣS_1	ΣS_2	ΣS_3	ΣS_4	ΣS_5	HI	QP (1 ω)
	-0.2623	-0.1323	0.0783	-0.4032	-0.3870	53.9	-0.4%
h 或 ω %	LA'	$\Delta H'$	x'_i	x'_s	$x'_i - x'_s$	K'_{T1}	$K'_{T0.7}$
100	-1.749	-0.234	-1.337	0.223	-1.560	-2.1169	0.0585
70	-0.550	-0.205	-0.396	-0.656	0.260	-2.3123	-0.2289

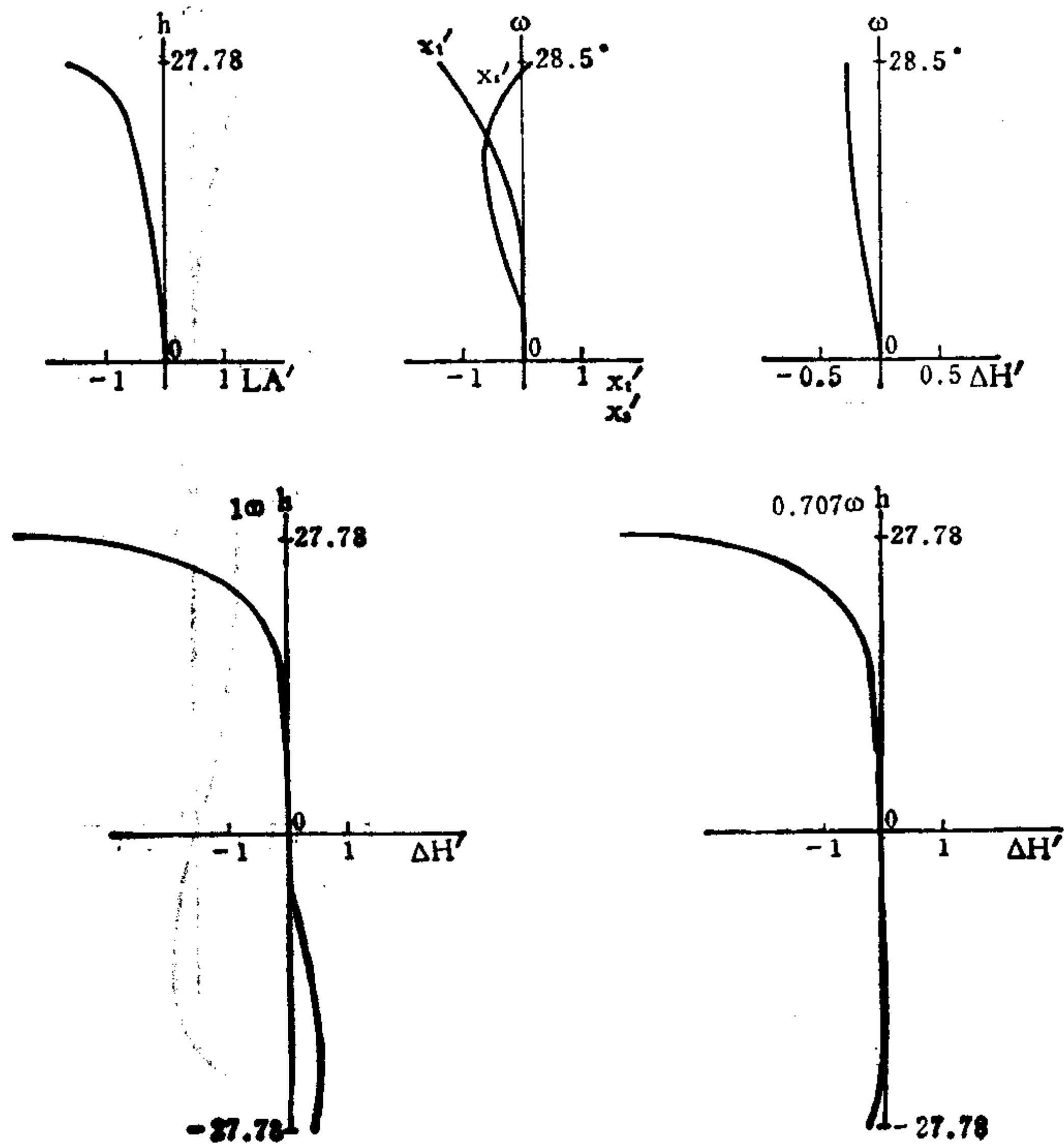

编号: 07-02-024

准广角大孔径物镜

E.F.L = 100

B.F.L = 92.6

FNo. = 1.8

F.A. = ± 28.9°

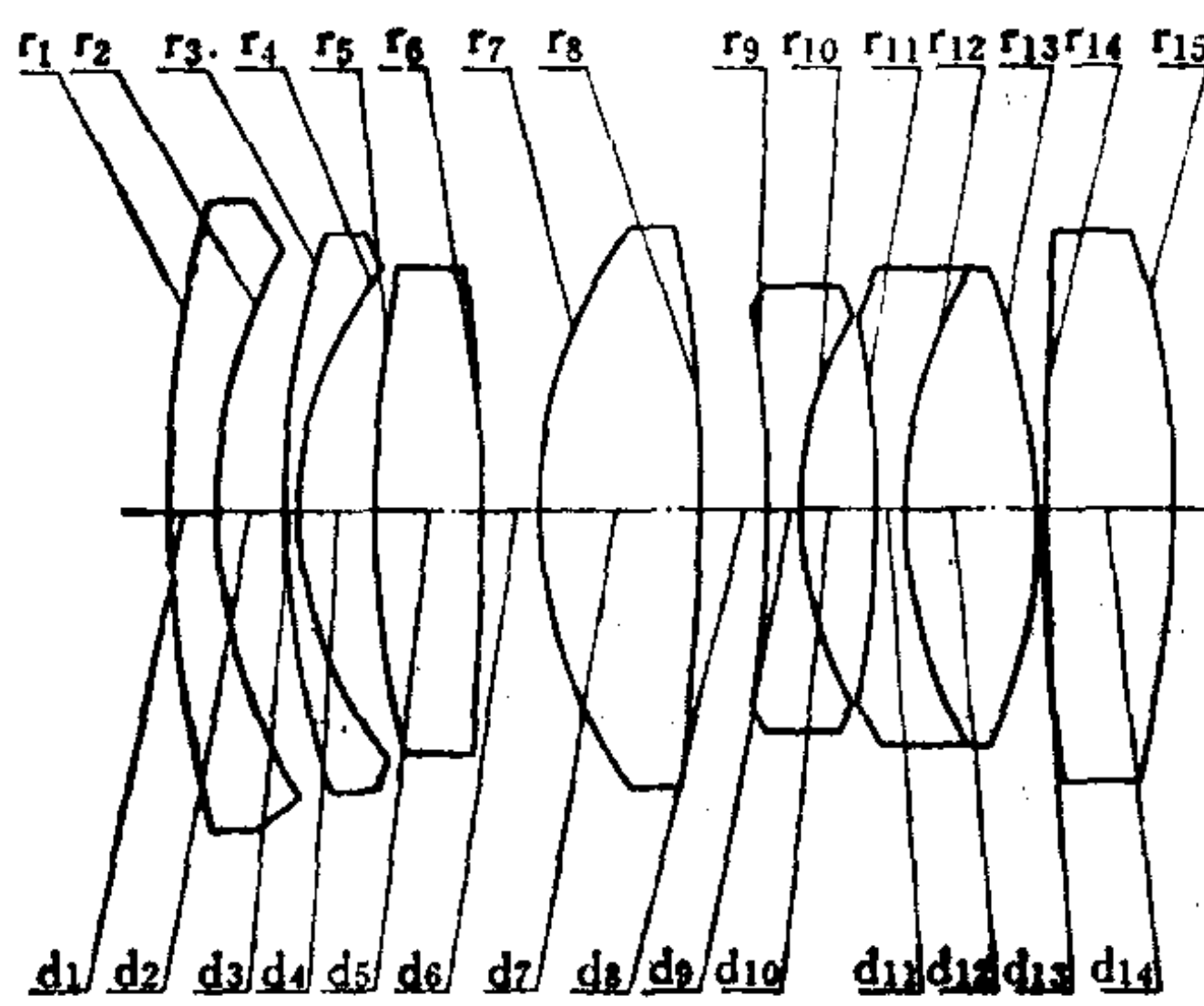

序号	r	d	n	v	序号	r	d	n	v
1	175.400	6.90	1.53172	48.9	9	-195.000	6.25	1.72825	28.5
2	73.563	9.42			10	58.013	10.25*		
3	128.468	3.00	1.54072	47.2	11	-176.700	3.75	1.69895	30.1
4	56.023	10.95			12	70.078	18.85	1.78590	44.2
5	168.280	15.37	1.83400	37.2	13	-79.025	0.25		
6	-3453.988	8.27			14	996.250	18.80	1.65830	53.4
7	71.325	23.82	1.79952	42.3	15	-155.585			
8	-246.250	9.05							

10.25° = 5.00 + 5.25

	ΣS_1	ΣS_2	ΣS_3	ΣS_4	ΣS_5	HW	QP (1 ω)
/	-0.2012	0.0809	0.0043	-0.3189	-0.5285	55.25	-1.8%
h 或 ω %	LA'	$\Delta H'$	x'_t	x'_s	$x'_t - x'_s$	K'_{T1}	$K'_{T0.7}$
100	-0.0611	-0.999	-0.1125	0.6208	-0.7333	-5.1149	-0.9011
70	-0.2504	-0.396	-0.3790	-0.5437	0.1647	-1.3155	-0.1206

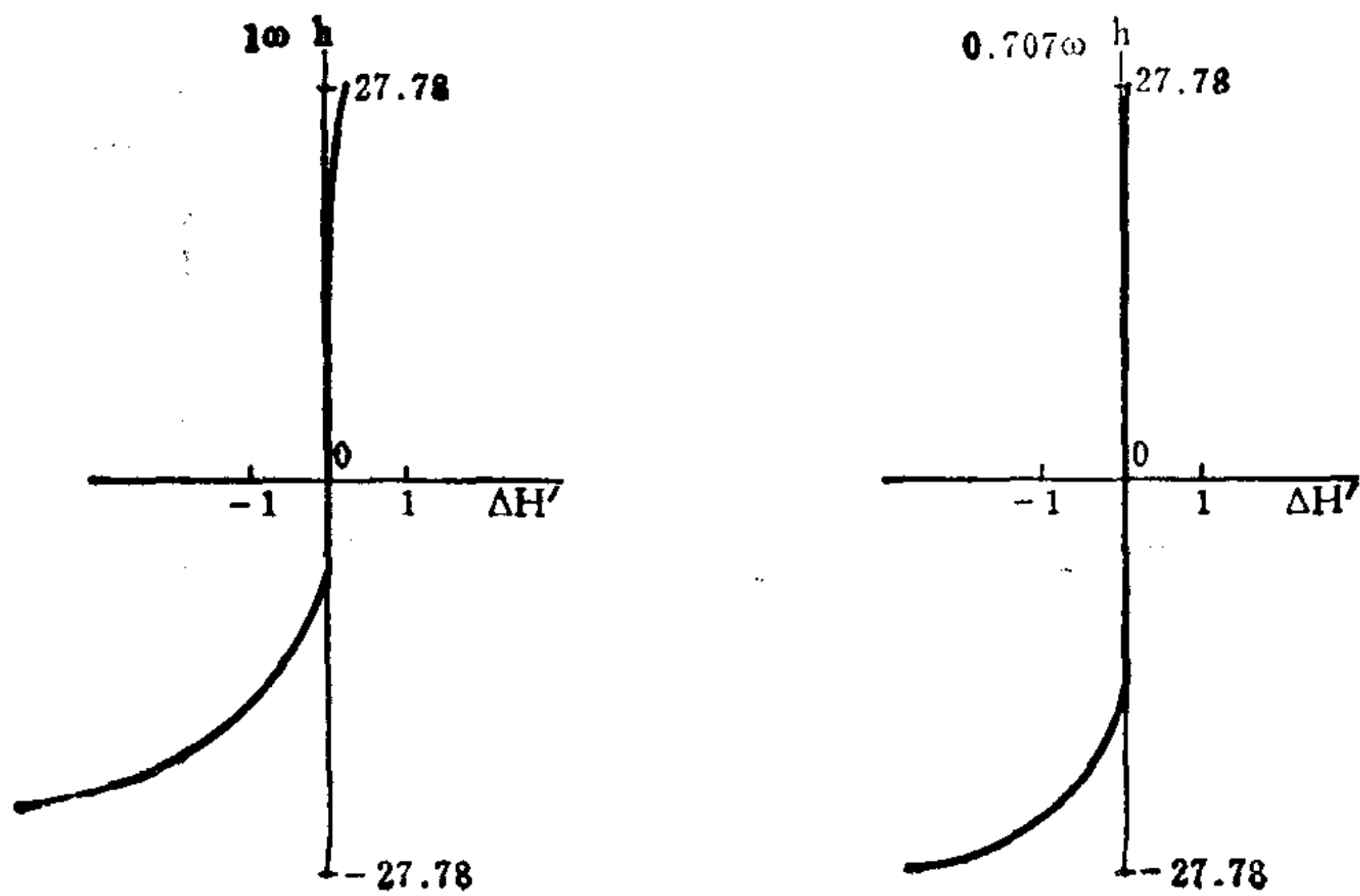
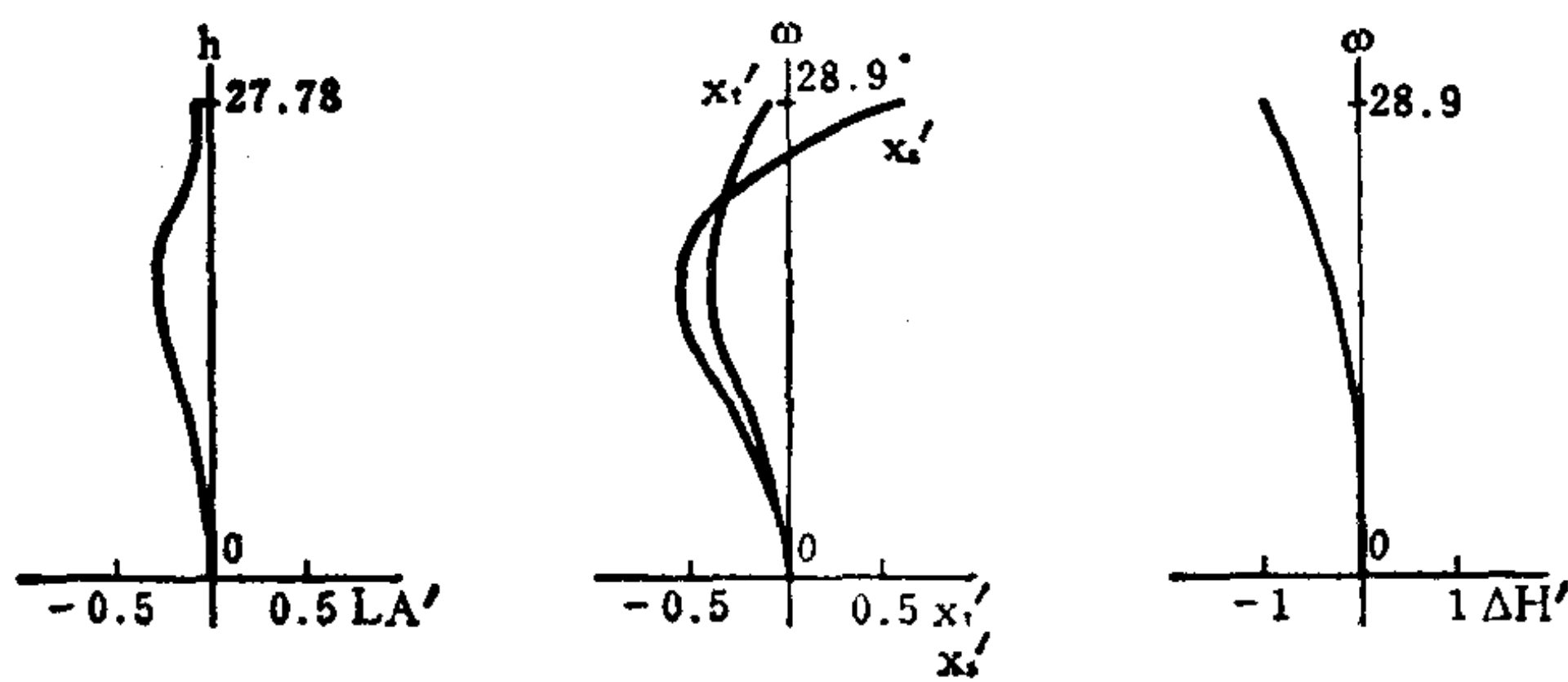

编号: 07-02-025

准 广 角 大 孔 径 物 镜

E.F.L = 100

B.F.L = 93.3

FNo. = 1.8

F.A. = $\pm 28.8^\circ$

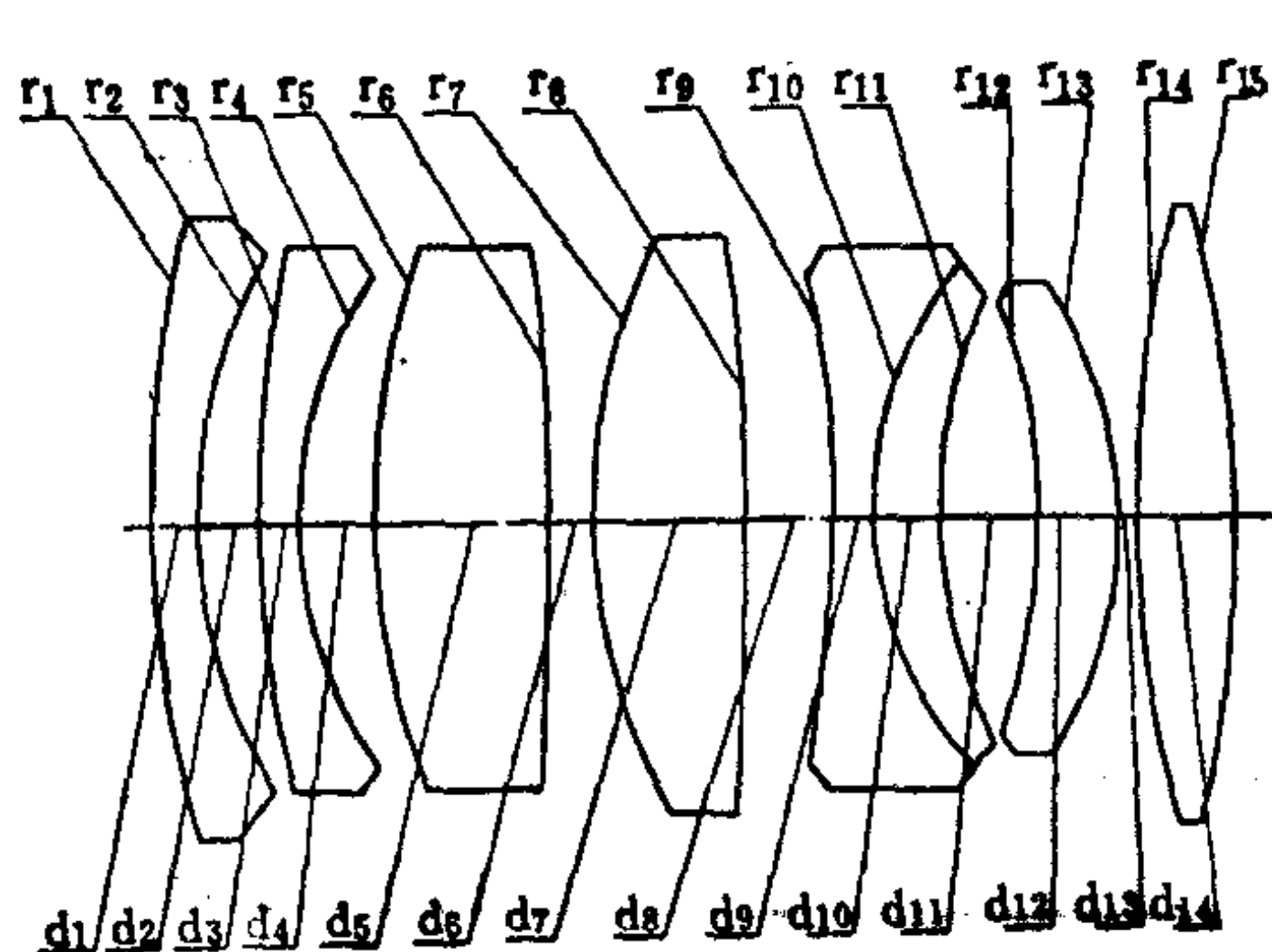

序号	r	d	n	v	序号	r	d	n	v
1	217.623	6.17	1.49782	66.8	9	-215.345	5.00	1.84666	23.9
2	69.596	9.20			10	57.528	9.77	1.78800	47.5
3	234.650	4.75	1.51454	54.7	11	79.998	13.67		
4	64.373	12.02			12	-87.823	10.60	1.77250	49.6
5	108.900	23.57	1.83400	37.2	13	-62.057	0.25		
6	-34888.149	6.52			14	182.638	14.45	1.81600	46.8
7	91.838	21.75	1.78800	47.5	15	-229.152			
8	-269.731	12.27*							

12.27* = 6.00 + 6.27

	ΣS_1	ΣS_2	ΣS_3	ΣS_4	ΣS_5	HI	QP (1 ω)
	-0.1770	0.0367	0.0823	-0.3721	-0.5173	54.9	-1.8%
h 或 ω %	LA'	$\Delta H'$	x'_t	x'_s	$x'_t - x'_s$	K'_{T1}	$K'_{T0.7}$
100	0.0393	-0.973	-0.292	0.543	-0.835	-0.7582	-0.0542
70	-0.3092	-0.360	-0.219	-0.546	0.327	-0.4398	-0.0255

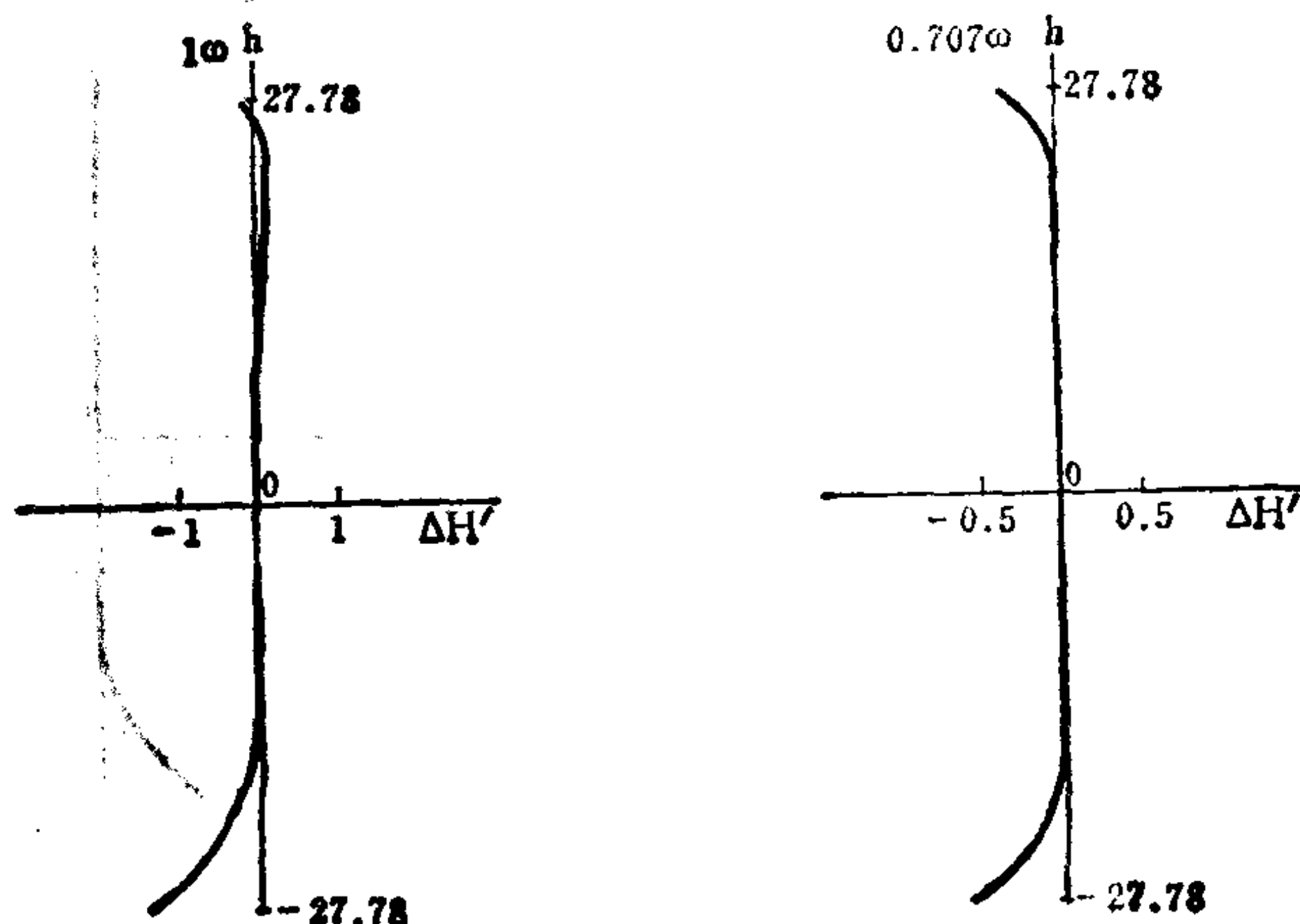
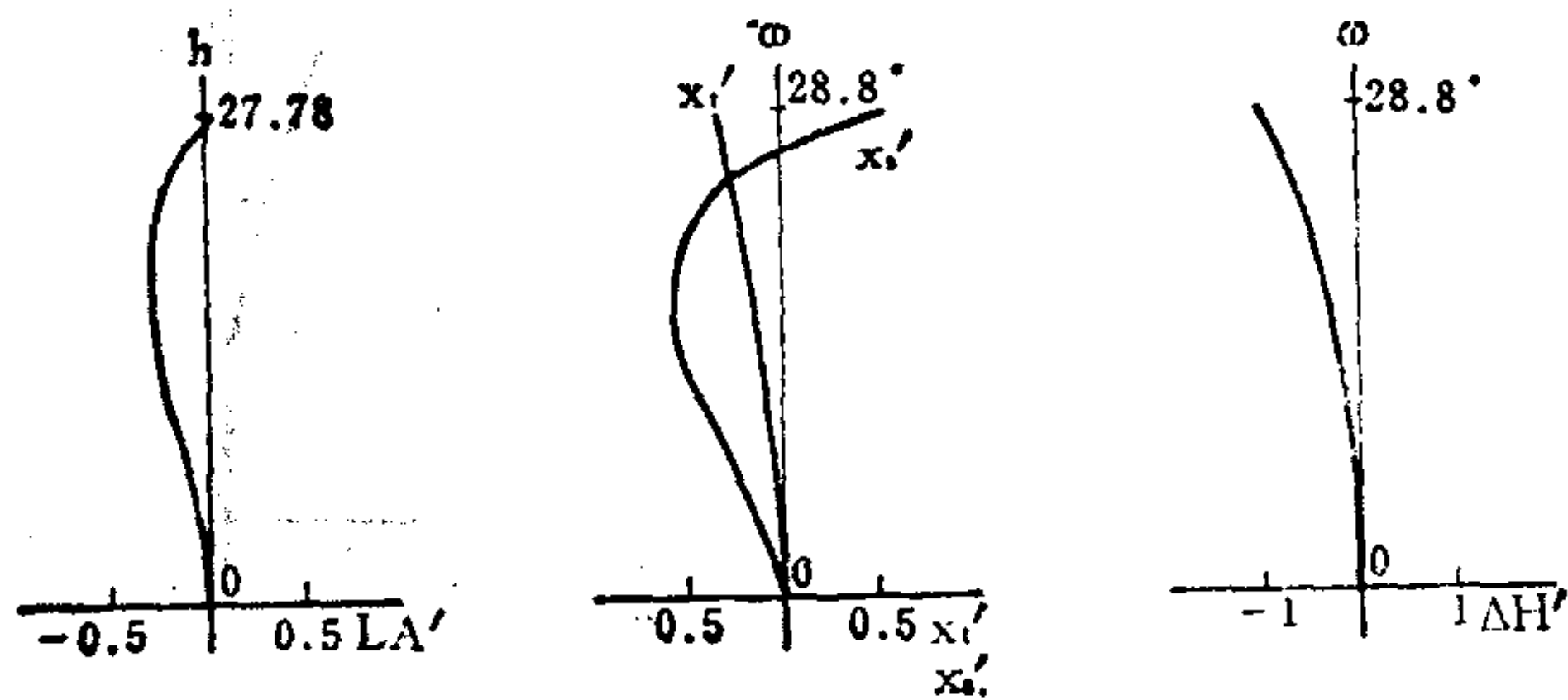

编号: 07-02-026

五片式反远距型广角物镜

E.F.L=1

B.F.L=1.06

FNo.=2.8

F.A.=±32°

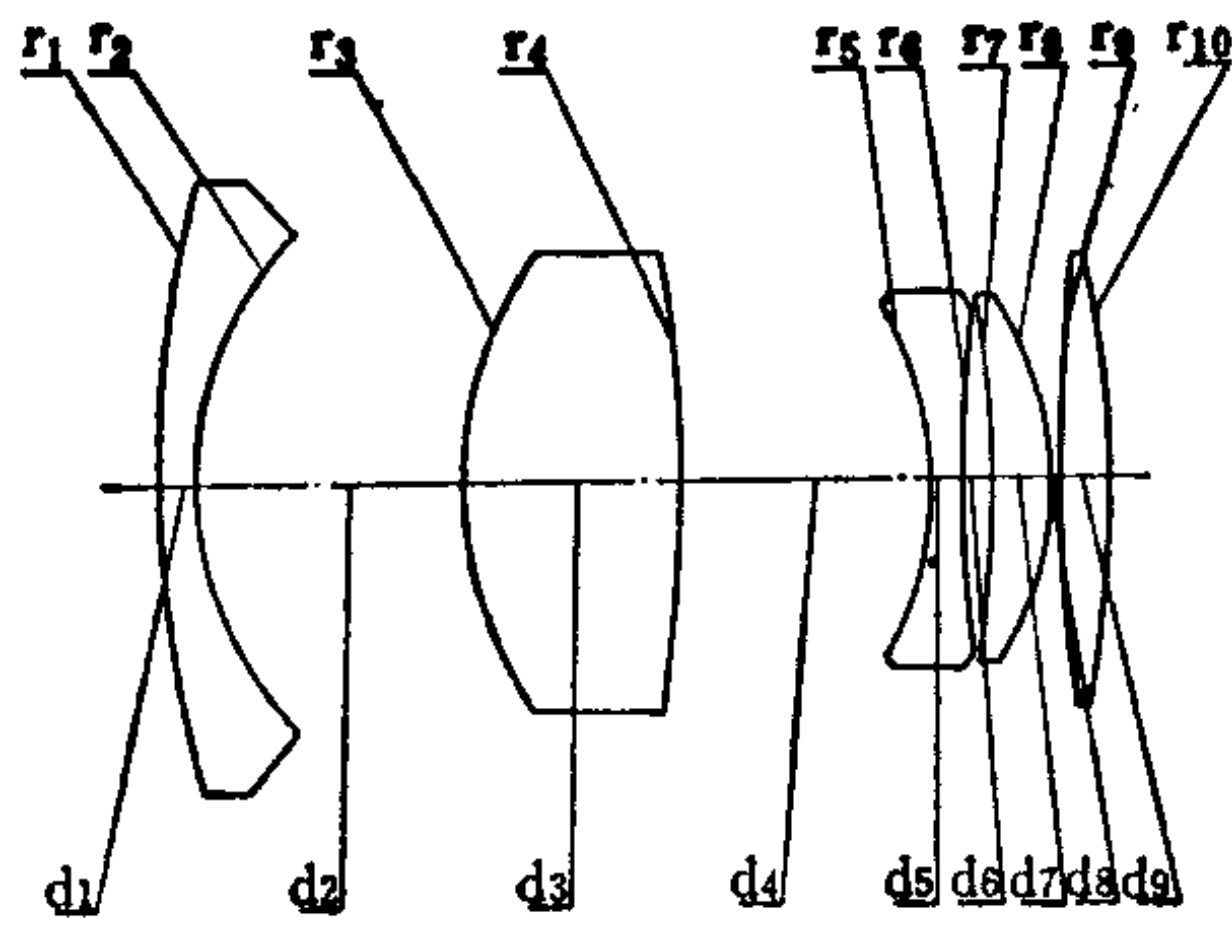

序号	r	d	n	v	序号	r	d	n	v
1	2.3437	0.0441	1.5714	53.0	6	2.3930	0.0283		
2	0.4709	0.3538			7	-1.4595	0.0670	1.7200	50.3
3	0.6206	0.2800	1.6583	58.5	8	-0.4496	0.0029		
4	-1.8643	0.3182*			9	2.4019	0.0680	1.6204	60.3
5	-0.4012	0.0379	1.6889	31.2	10	-1.1931			

$0.3182^* = 0.1600 + 0.1582$

	ΣS_1	ΣS_2	ΣS_3	ΣS_4	ΣS_5	HI	QP(1 ω)
	-0.000909	-0.000031	0.000184	-0.001549	-0.004084	0.62	-1.4%
h 或 ω %	LA'	$\Delta H'$	x'_i	x'_s	$x'_i - x'_s$	K'_{T1}	$K'_{T0.7}$
100	-0.00375	-0.00879	-0.01320	0.00012	-0.01332	-0.00148	-0.00062
70	-0.00517	-0.00421	-0.00766	-0.00774	0.00008	-0.00078	-0.00020

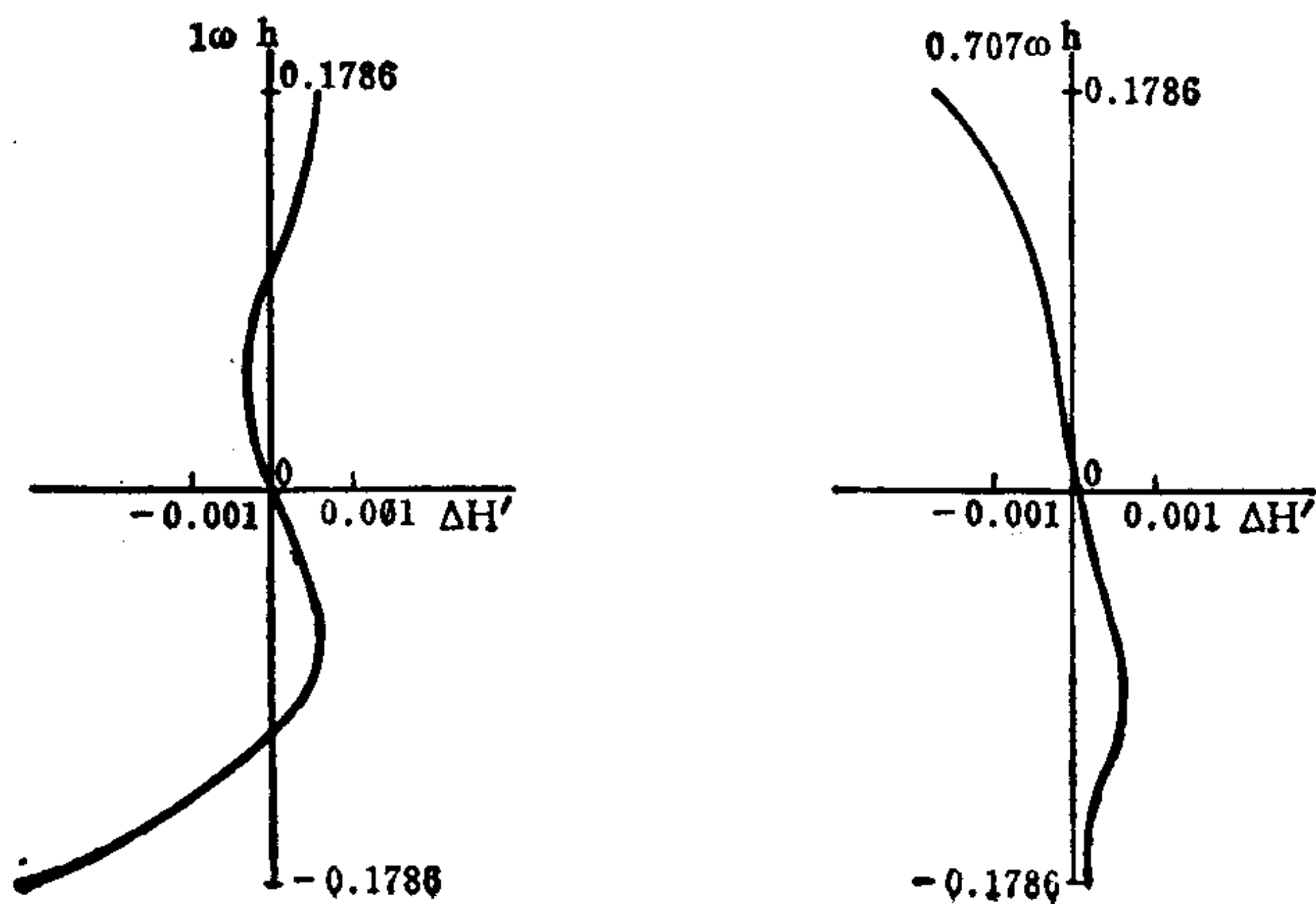
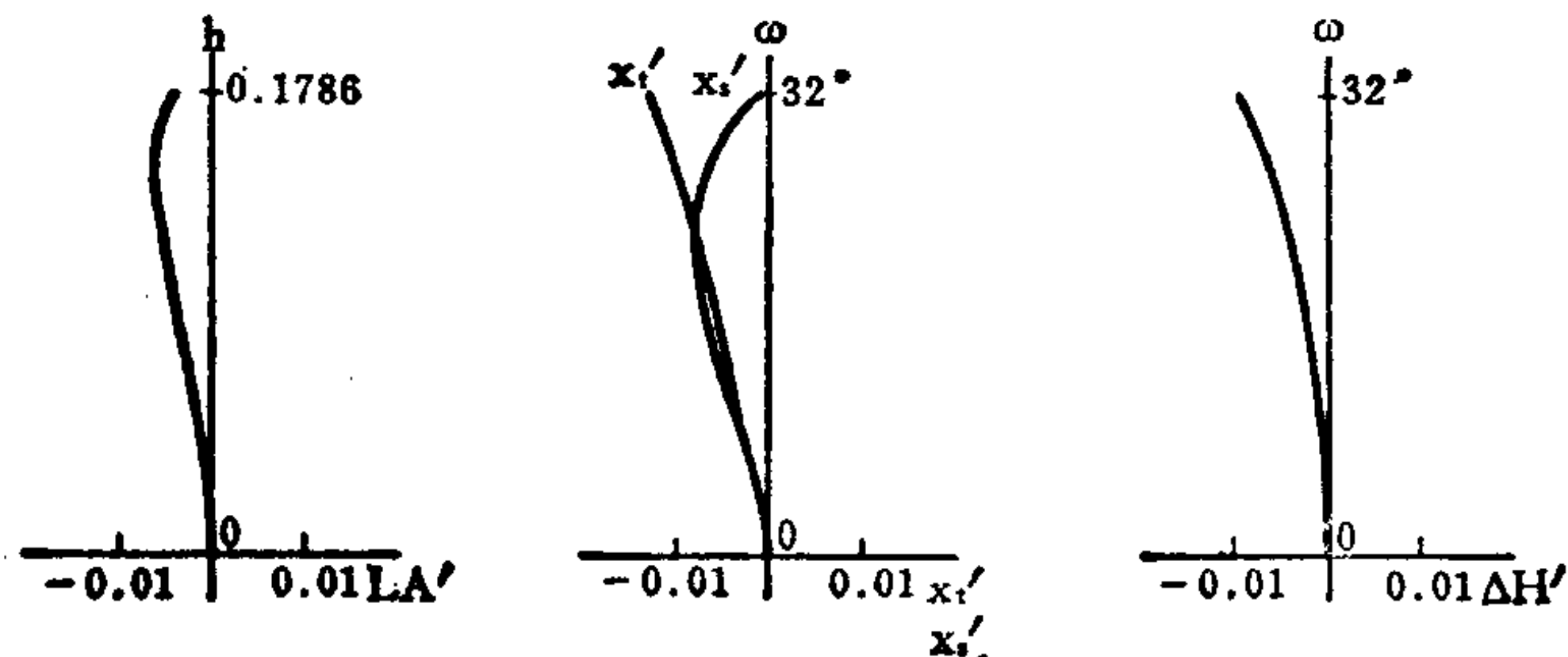

编号: 07-02-027

五片式反远距型广角物镜

E.F.L=1

B.F.L=1.06

FNo.=2.8

F.A.=±32°

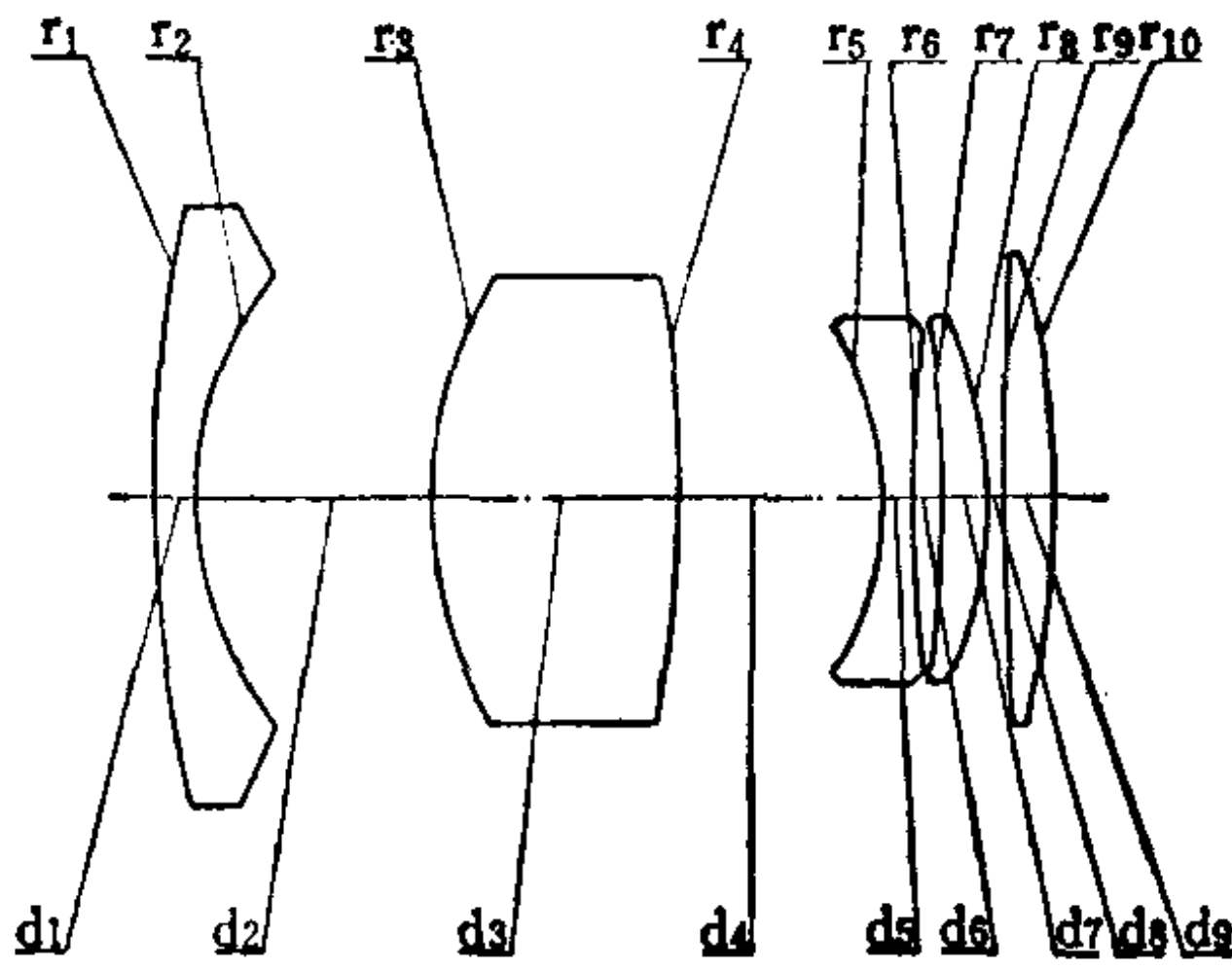

序号	r	d	n	v	序号	r	d	n	v
1	2.5414	0.0469	1.5725	57.5	6	2.1911	0.0376		
2	0.4915	0.3284			7	-1.9373	0.0670	1.7495	50.1
3	0.6600	0.3345	1.6968	55.6	8	-0.4795	0.0029		
4	-1.8698	0.2722*			9	4.3712	0.0680	1.6214	61.3
5	-0.4287	0.0428	1.7006	30.1	10	-1.1652			

$0.2722^* = 0.1400 + 0.1322$

	ΣS_1	ΣS_2	ΣS_3	ΣS_4	ΣS_5	HI	QP(1 ω)
	-0.001096	-0.000037	0.000244	-0.001650	-0.004297	0.62	-1.4%
h 或 ω %	LA'	$\Delta H'$	x'_t	x'_s	$x'_t - x'_s$	K'_{T1}	$K'_{T0.7}$
100	-0.00292	-0.00912	-0.01388	-0.00072	-0.01316	-0.00003	0.00103
70	-0.00602	-0.00442	-0.00677	-0.00805	0.00128	-0.00153	-0.00011

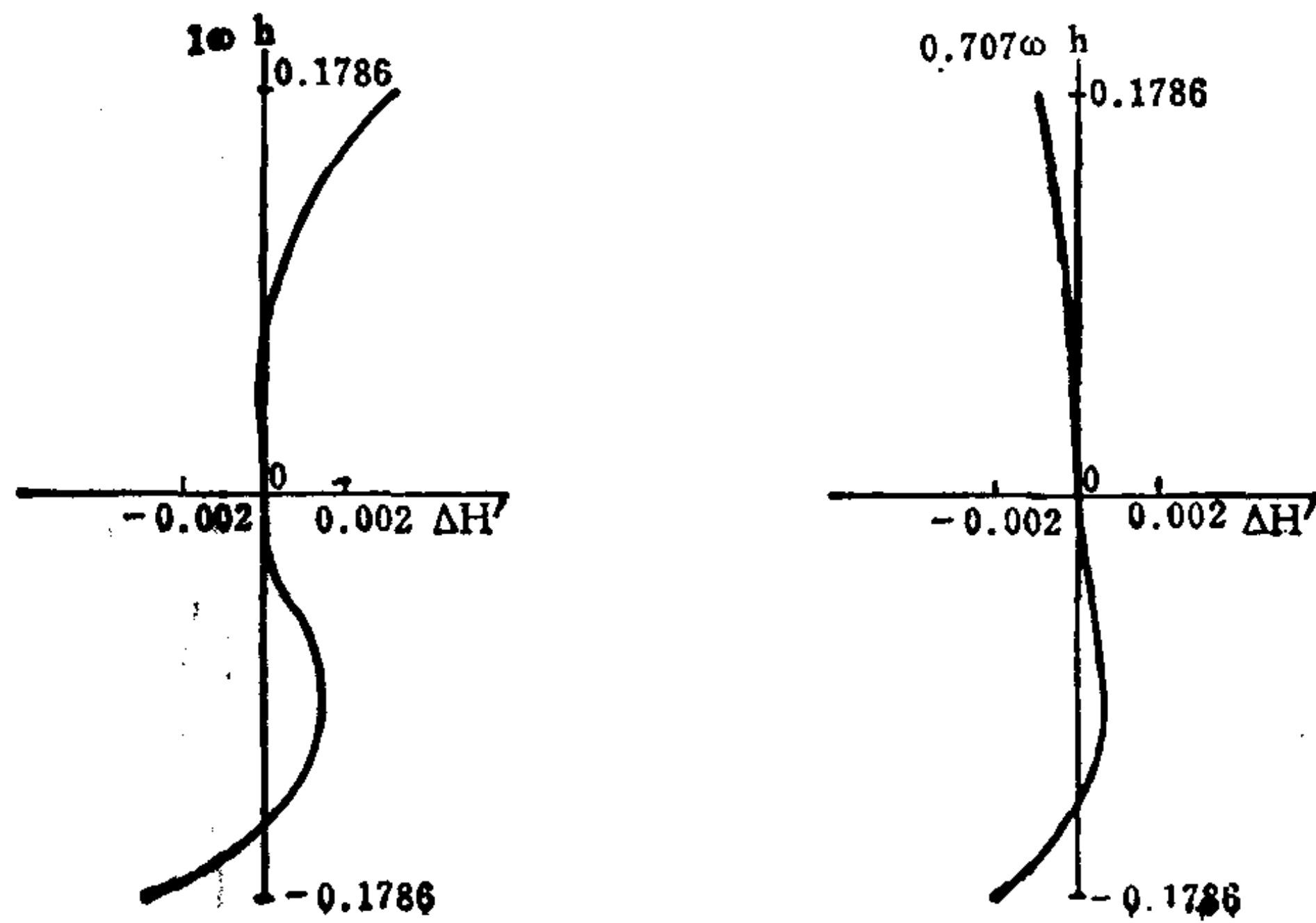
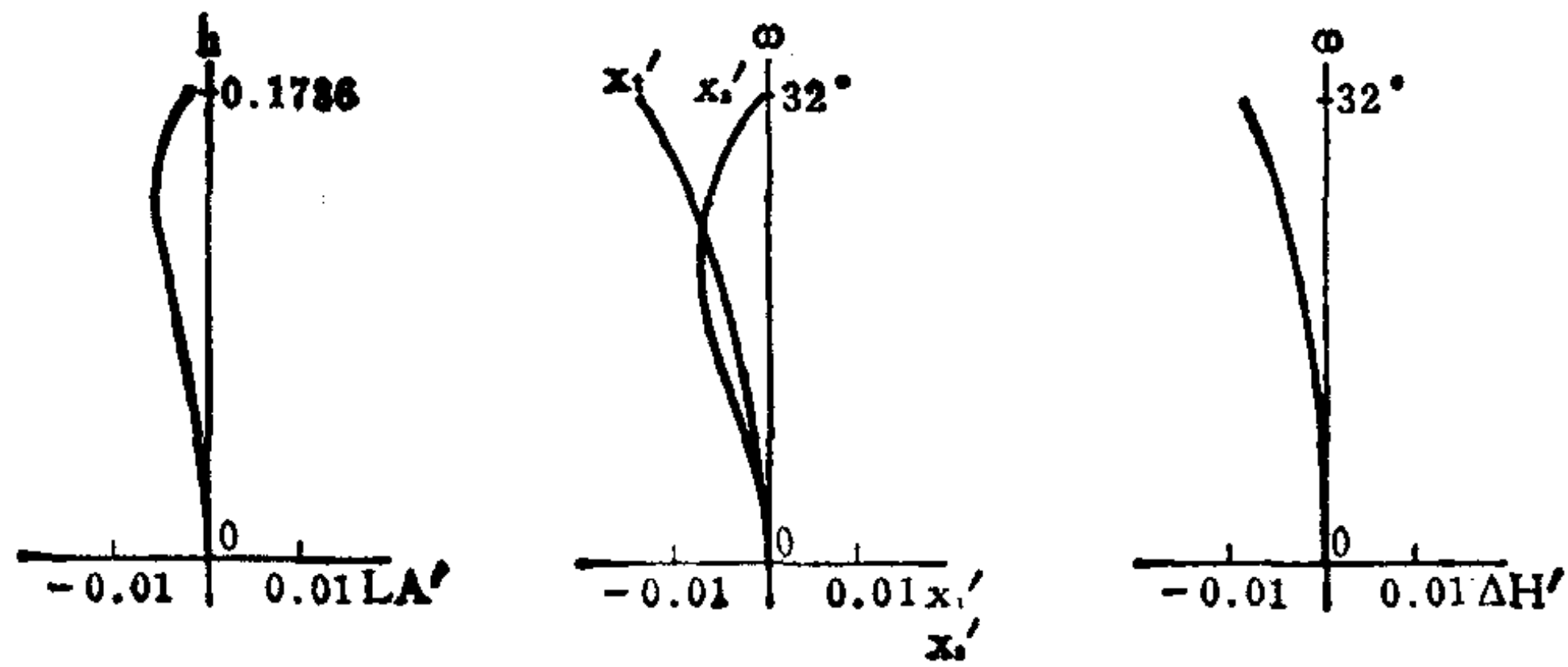

编号: 07-02-028

广角物镜

E.F.L = 99.8

B.F.L = 178.36

FNo. = 2.8

F.A. = ±47.24°

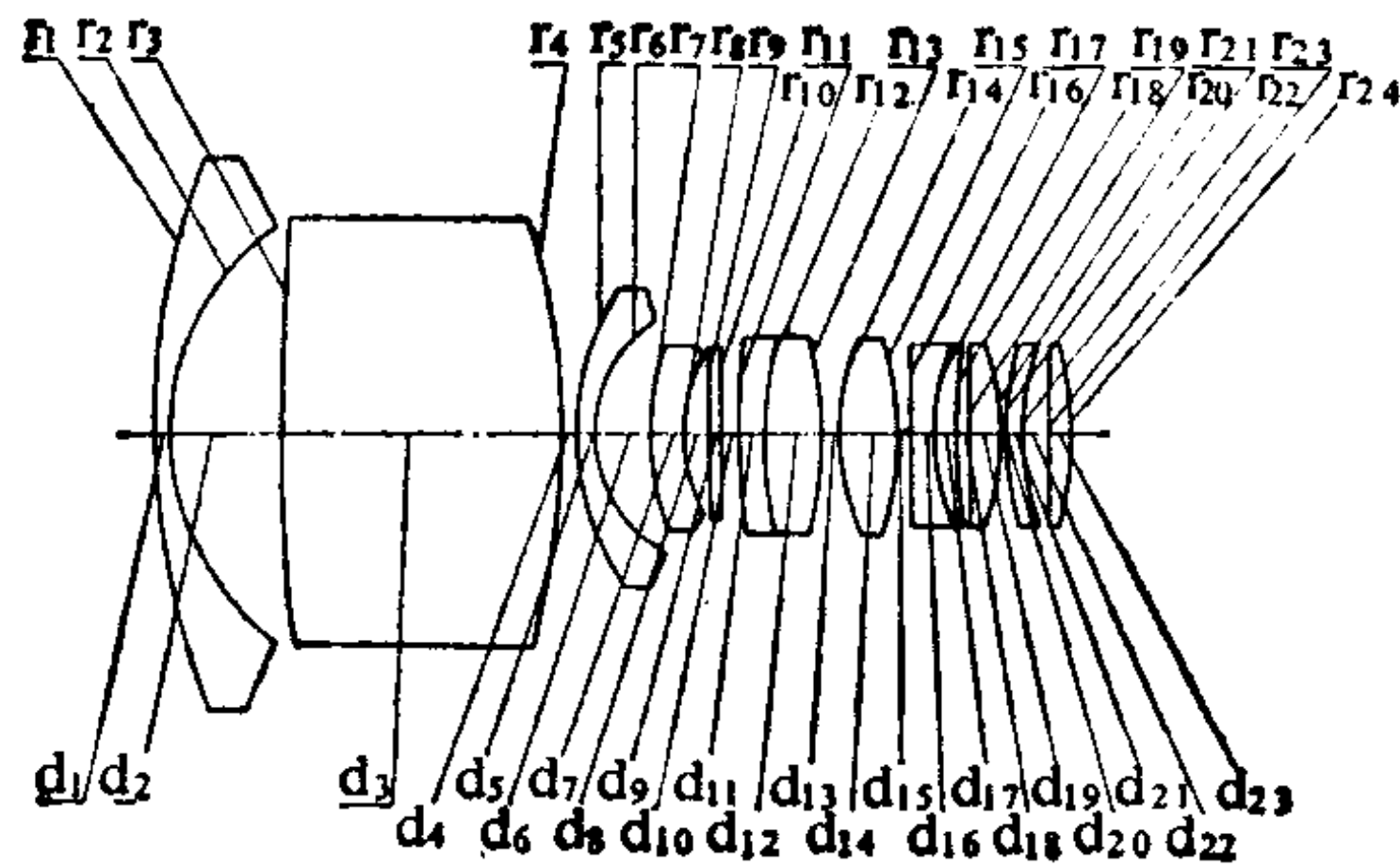

序号	r	d	n	v	序号	r	d	n	v
1	324.0	5.82	1.6400	60.2	13	-189.7	7.76*		
2	126.0	54.94			14	159.7	26.74	1.5892	41.1
3	3321.8	139.21	1.6204	60.3	15	-236.3	5.67		
4	-350.9	0.48			16	∞	11.40	1.8051	25.4
5	119.7	10.19	1.5119	58.1	17	95.5	10.63	1.6393	44.9
6	58.5	28.29			18	202	7.18		
7	189.8	14.56	1.8160	46.8	19	4078.3	15.48	1.6170	62.8
8	86.5	12.13			20	-110.2	0.97		
9	∞	3.88	1.5163	64.1	21	342.2	7.28	1.8051	25.4
10	∞	4.85			22	108.8	14.27		
11	487.4	11.26	1.8074	35.4	23	∞	14.02	1.7865	50.2
12	216.3	28.73	1.7407	27.8	24	-169.6			

7.76* = 3.90 + 3.86

	ΣS ₁	ΣS ₂	ΣS ₃	ΣS ₄	ΣS ₅	HI	QP (1ω)
	-0.1862	0.0160	0.0667	-0.2266	-1.5849	107.9	-3%
h 或 ω %	LA'	ΔH'	x' _t	x' _s	x' _t - x' _s	K' _{T1}	K' _{T0.7}
100	0.0783	-3.298	-1.147	0.606	-1.753	-0.4707	-0.1954
70	-0.7797	-2.093	-0.4926	-1.3195	0.8269	-0.2813	-0.0360

注: 镜片 5 是滤色片。

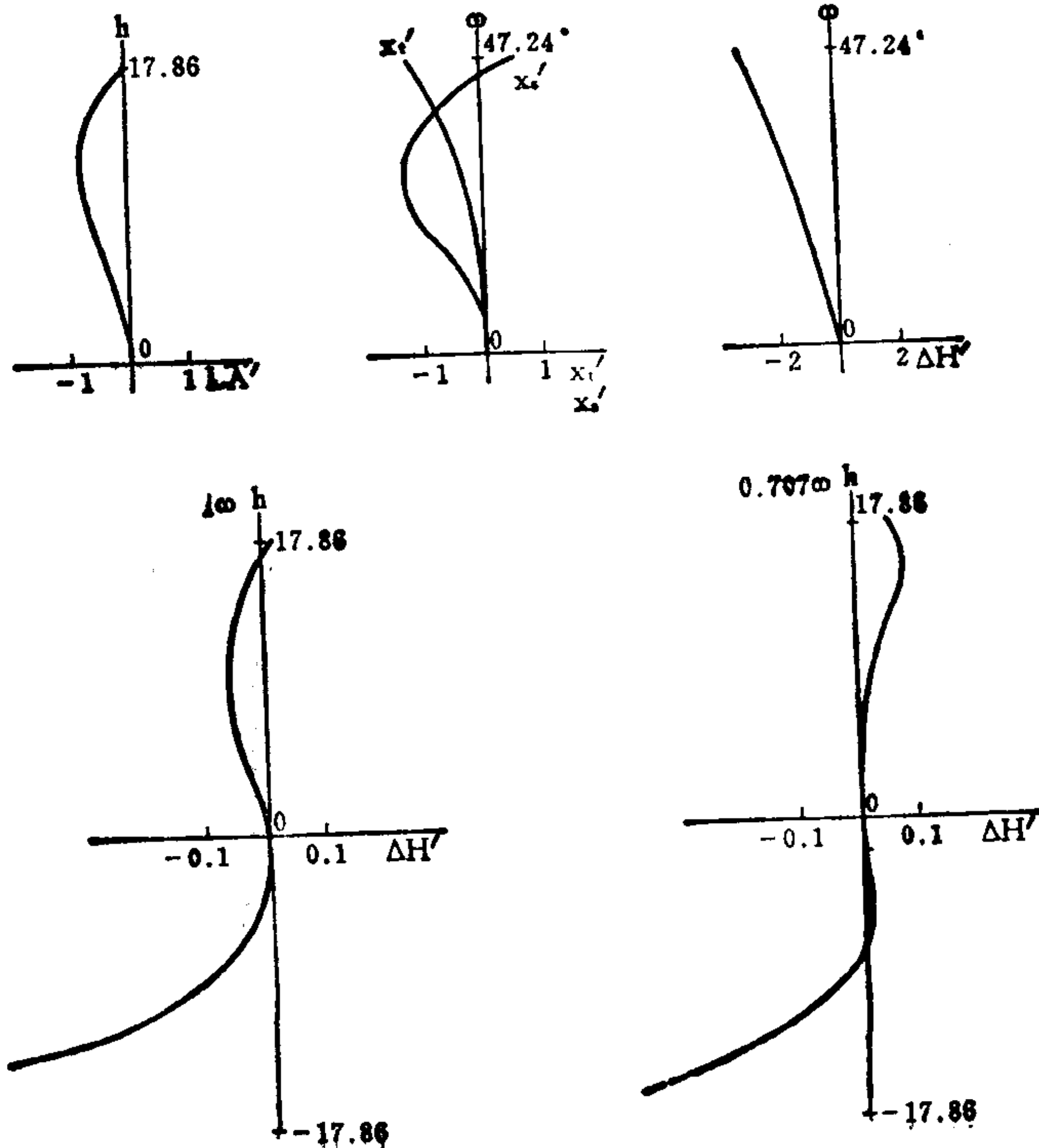

编号: 07-02-029

广 角 物 镜

E.F.L=100

B.F.L=183.8

FNo.=2.8

F.A.=±47.3°

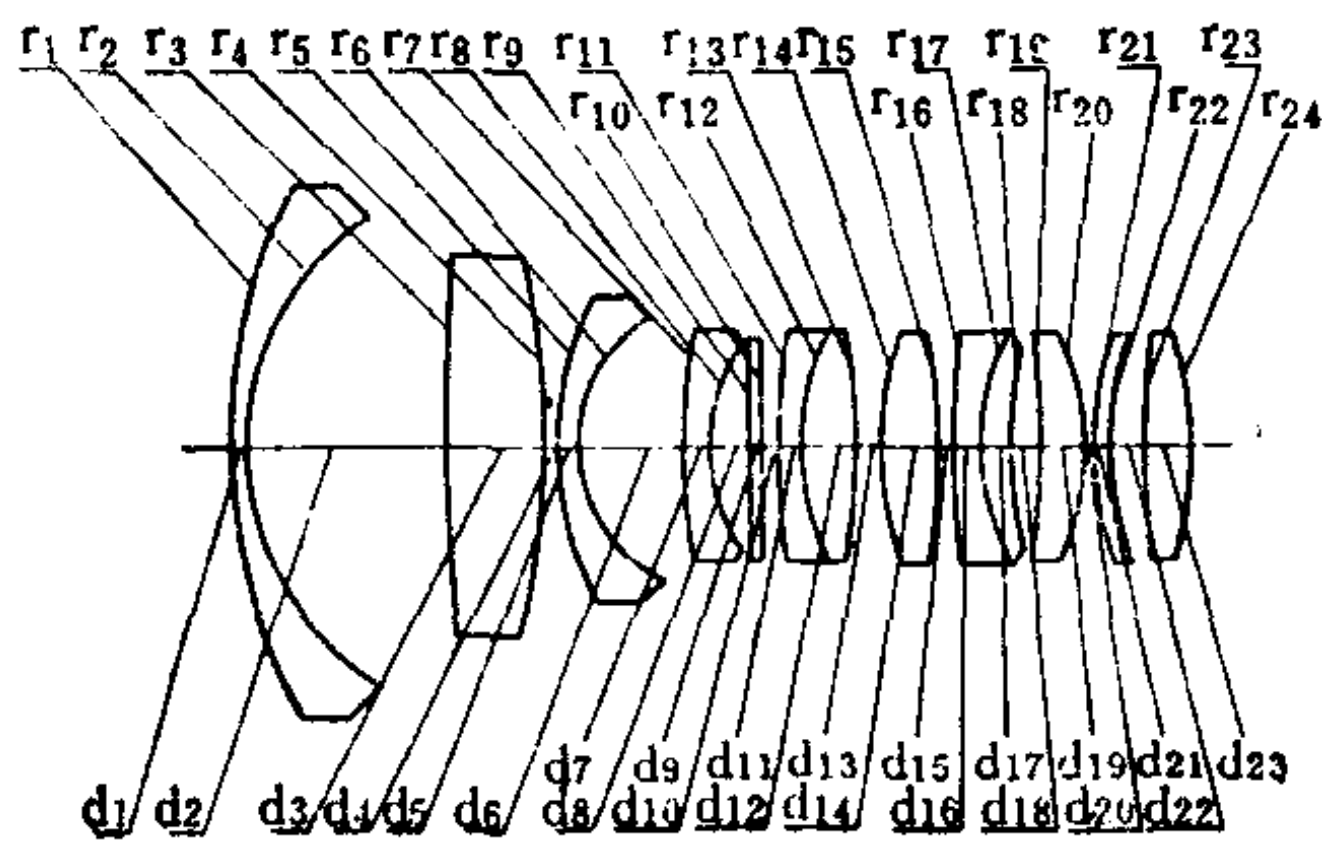

序号	r	d	n	v	序号	r	d	n	v
1	219.2	5.84	1.6968	55.7	13	-165.7	7.30*		
2	110.9	78.58			14	134.7	24.34	1.5892	41.1
3	2434.5	39.00	1.5955	39.2	15	-211.6	1.85		
4	-369.4	0.53			16	35056.8	8.42	1.8051	25.4
5	132.9	8.91	1.6237	46.9	17	77.4	13.13	1.6700	47.3
6	59.3	37.58			18	169.7	9.73		
7	185.1	14.60	1.8061	40.8	19	-3408.3	17.72	1.6134	57.4
8	85.4	12.17			20	-105.6	0.43		
9	∞	3.89	1.5163	64.1	21	299.0	5.89	1.8466	23.9
10	∞	4.86			22	106.5	14.60		
11	420.8	11.44	1.8340	37.2	23	841.8	18.45	1.5891	61.1
12	92.6	20.88	1.7552	27.5	24	-147.5			

7.30* = 3.70 + 3.60

	ΣS_1	ΣS_2	ΣS_3	ΣS_4	ΣS_5	HI	QP(1 ω)
	-0.2606	0.0614	0.0387	-0.2739	-1.6052	108.3	-2.9%
h 或 ω %	LA'	$\Delta H'$	x'_t	x'_s	$x'_t - x'_s$	K'_{T1}	$K'_{T0.7}$
100	0.6354	-3.148	-2.901	-0.100	-2.801	-0.6541	-0.2889
70	-1.0642	-2.159	-1.256	-1.864	0.608	-0.3911	-0.0803

注: 镜片 5 是滤色片。

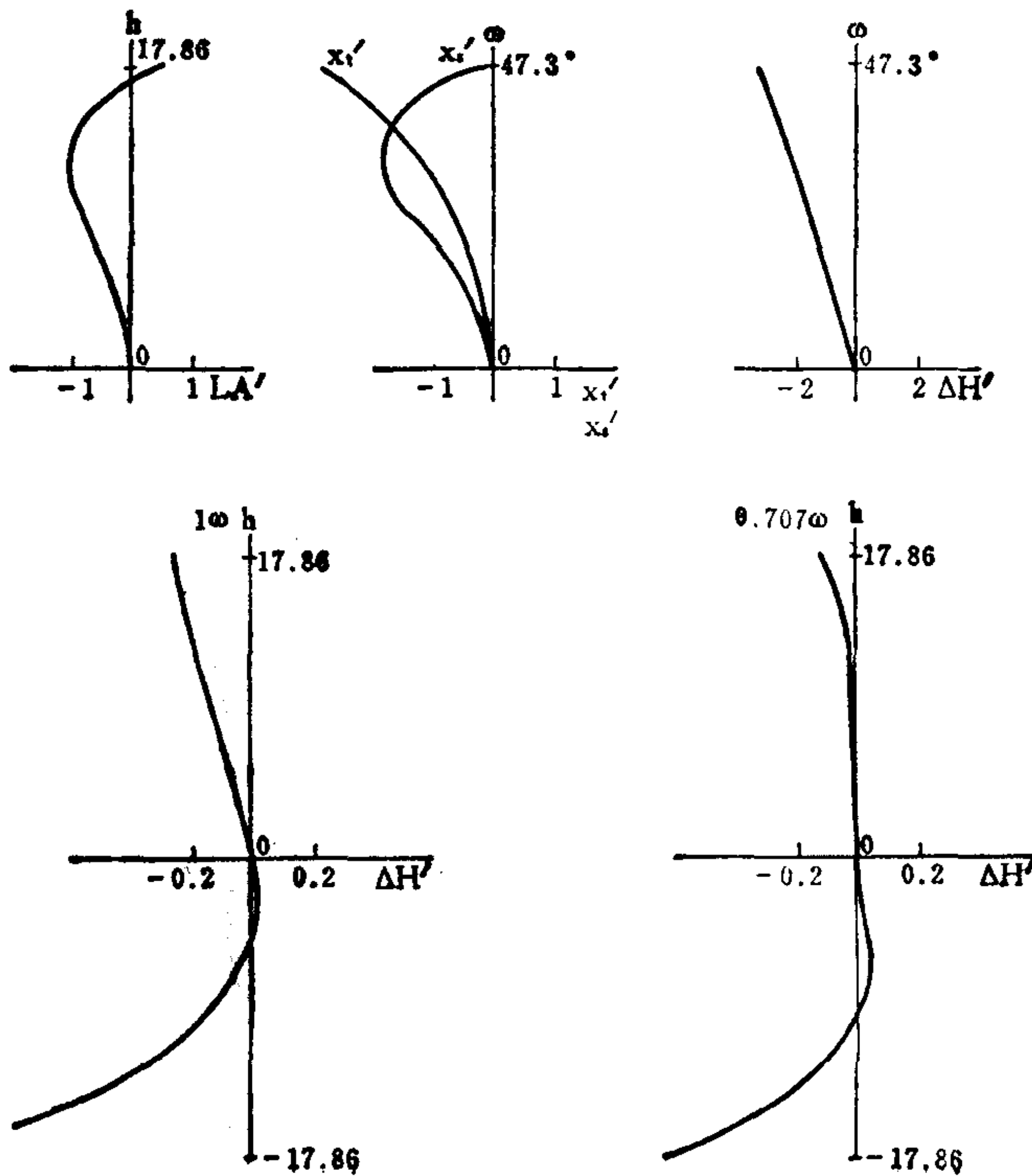

编号: 07-02-030

广角照相物镜

E.F.L = 100

B.F.L = 130.2

FNo. = 2.8

F.A. = ± 37.6°

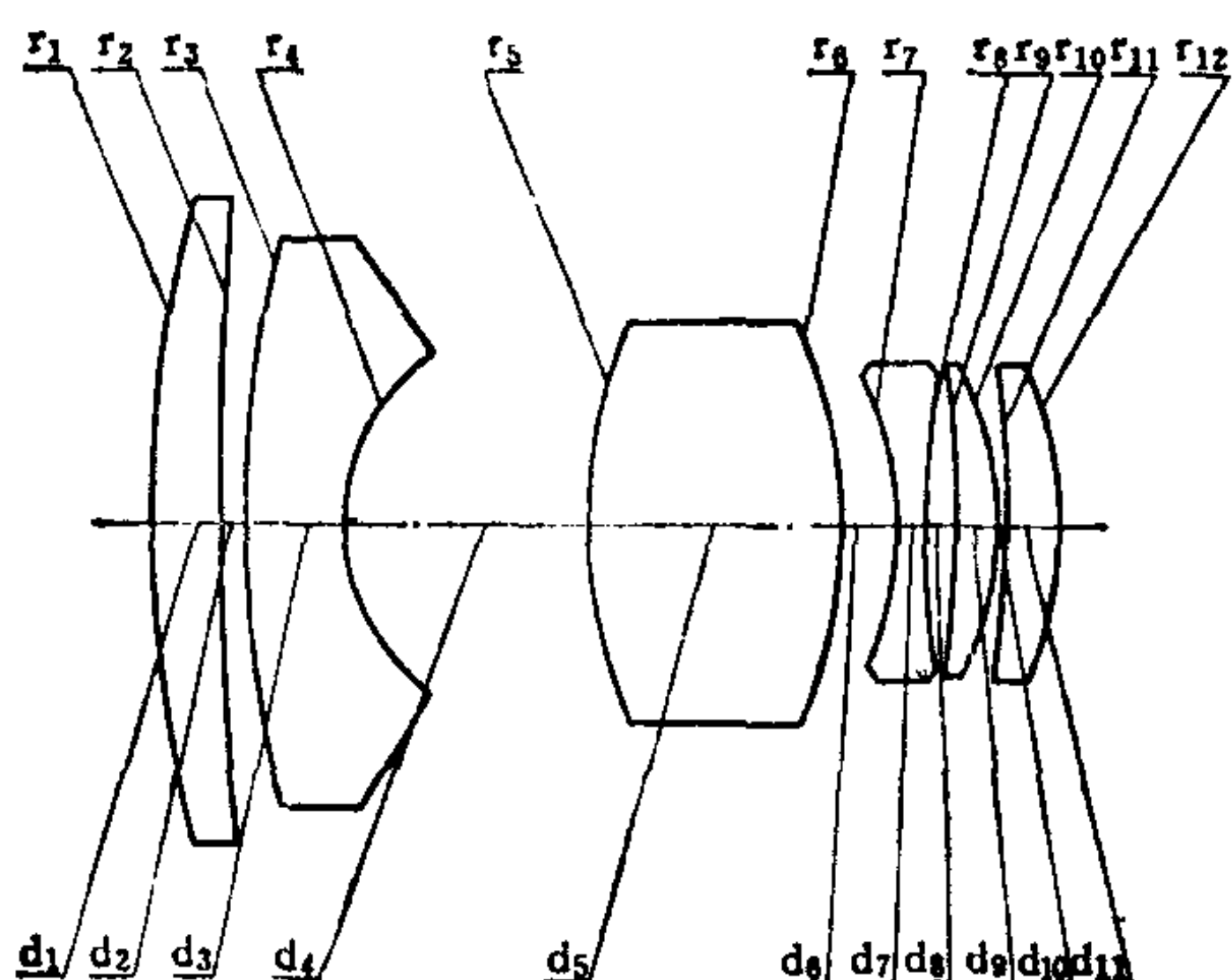

序号	r	d	n	v	序号	r	d	n	v
1	268.630	12.54	1.62280	57.0	7	-62.000	4.23	1.74077	27.8
2	1489.437	0.35			8	137.345	4.86		
3	179.577	19.23	1.62041	60.3	9	-237.782	8.06	1.62281	57.0
4	38.908	45.42			10	-64.877	0.35		
5	94.880	44.26	1.72000	43.7	11	-1802.817	8.52	1.62041	60.3
6	-85.317	10.56*			12	-81.169			

10.56* = 5.00 + 5.56

	ΣS_1	ΣS_2	ΣS_3	ΣS_4	ΣS_5	HI	QP (1 ω)
	-0.1373	0.0633	0.0106	-0.1929	-0.7027	77	-1.17%
h 或 ω %	LA'	$\Delta H'$	x'_t	x'_s	$x'_t - x'_s$	K'_{t1}	$K'_{t0.7}$
100	-0.049	-0.903	-2.894	-0.121	-2.773	-0.4622	-0.0484
70	-0.657	-0.752	-0.667	-1.014	0.347	-0.5135	-0.0841

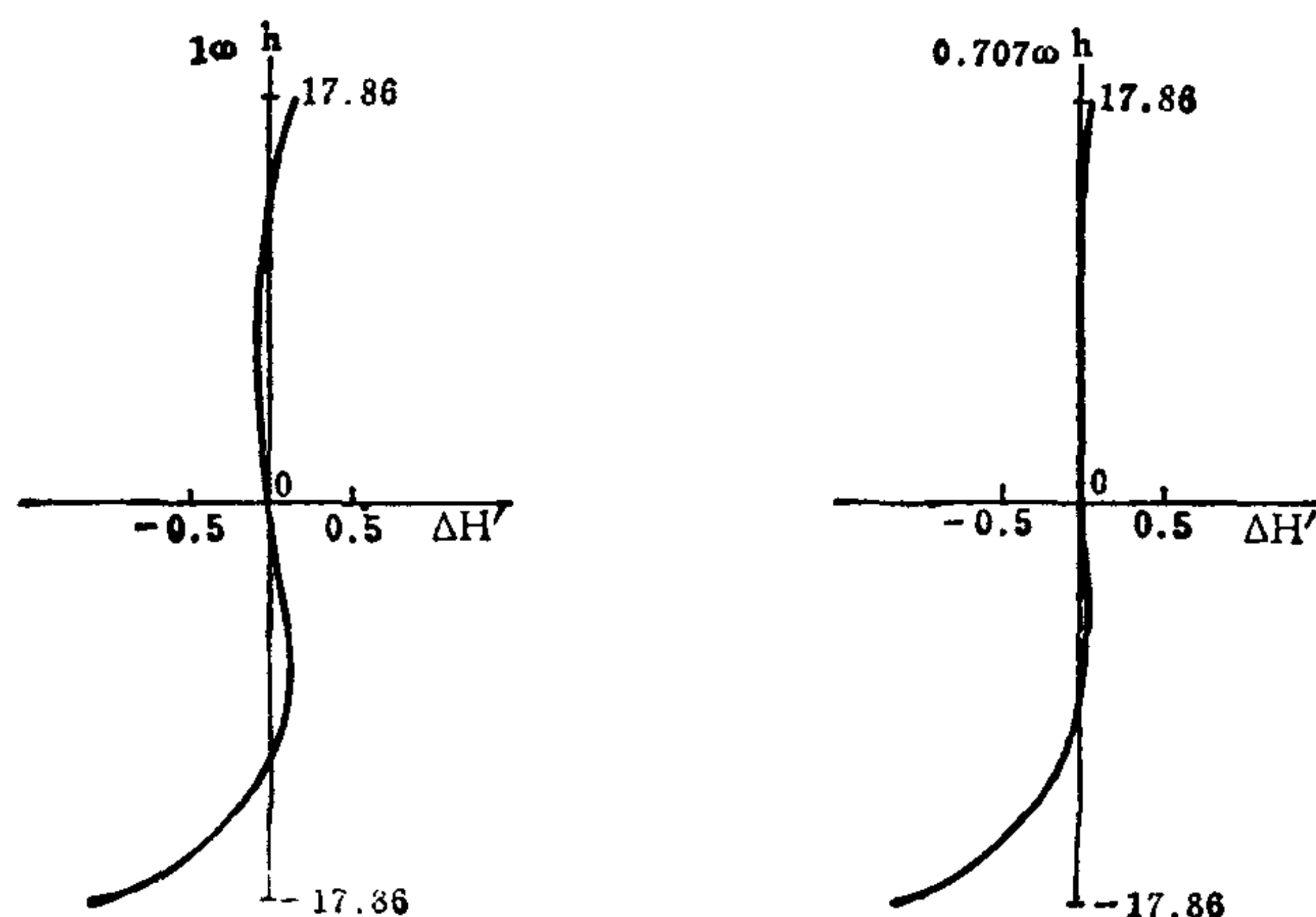
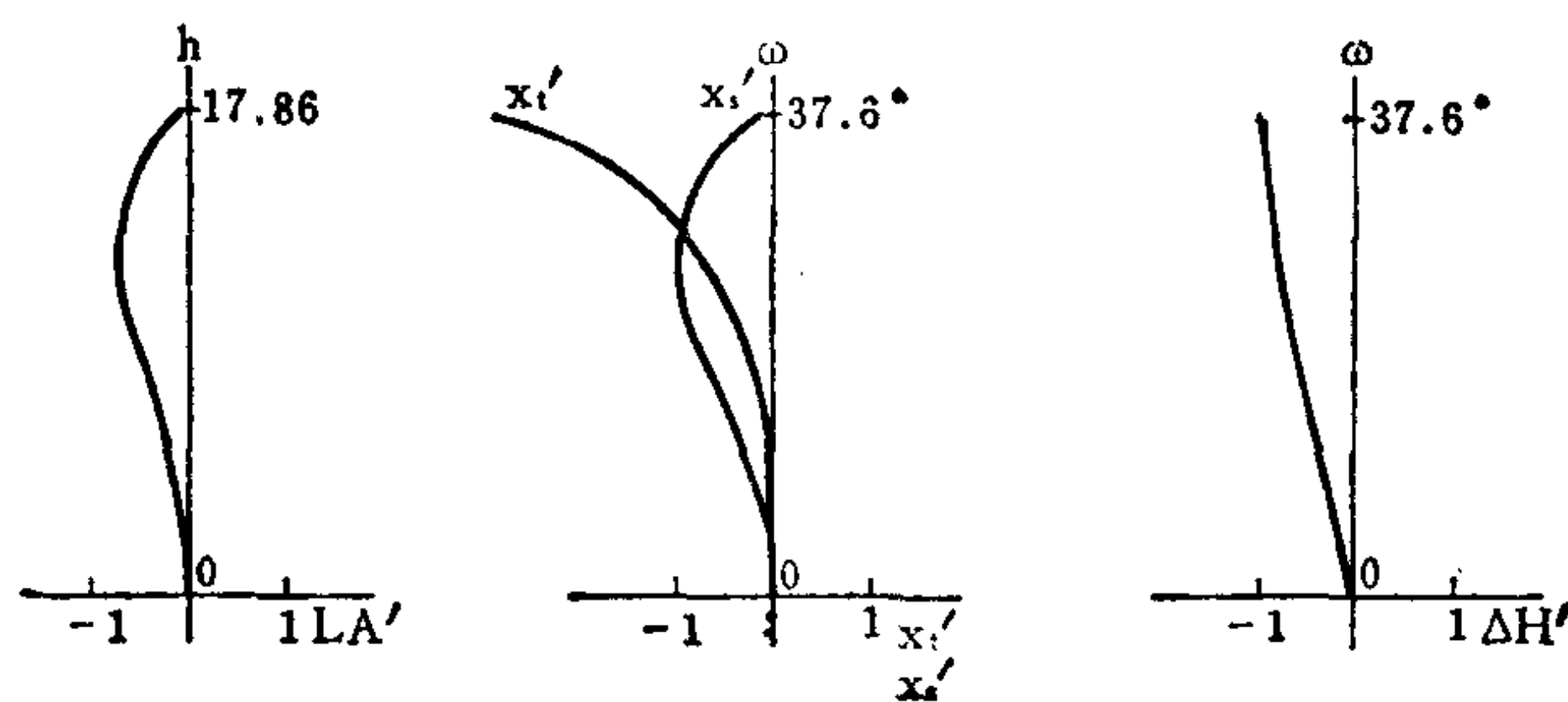

编号: 07-02-031

广角照相物镜

E.F.L=100 B.F.L=130.1 FNo.=3.5 F.A.=±37.6°

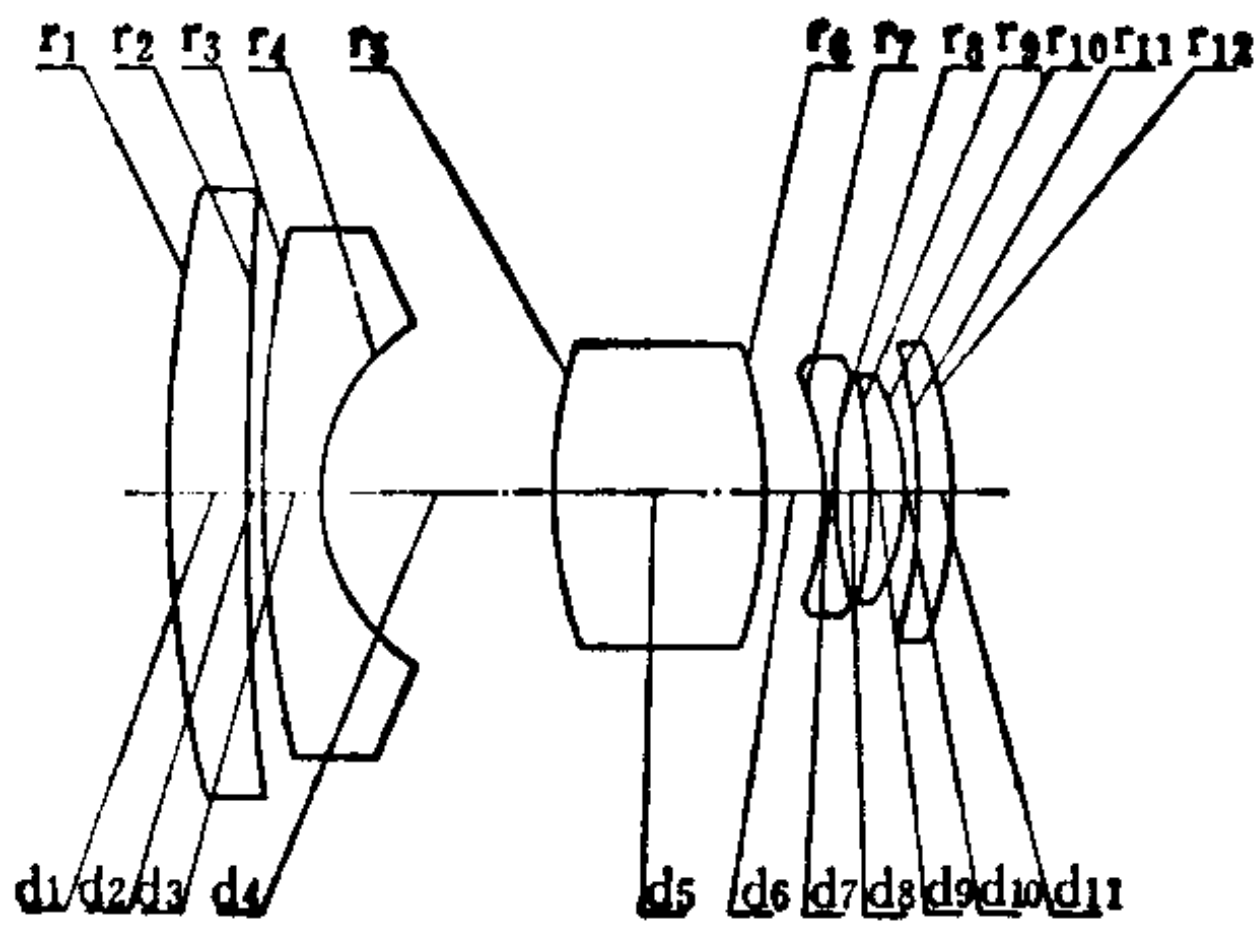

序号	r	d	n	v	序号	r	d	n	v
1	271.127	16.59	1.62280	57.0	7	-63.380	3.98	1.74077	27.8
2	3970.472	0.35			8	127.465	3.78		
3	213.933	13.45	1.62041	60.3	9	-256.651	7.22	1.62280	57.0
4	39.169	45.74			10	-57.049	0.35		
5	83.475	41.13	1.72000	43.7	11	-2112.676	7.36	1.62041	60.3
6	-100.352	10.56*			12	-93.014			

10.56* = 5.00 + 5.56

	ΣS_1	ΣS_2	ΣS_3	ΣS_4	ΣS_5	HI	QP(1 ω)
	-0.0448	0.0281	0.0125	-0.1241	-0.5705	76.99	-1%
h 或 ω %	LA'	$\Delta H'$	x'_t	x'_s	$x'_t - x'_s$	K'_{T1}	$K'_{T0.7}$
100	-0.079	-0.780	-2.923	-0.300	-2.623	-0.3057	-0.0776
70	-0.335	-0.746	-0.543	-1.034	0.491	-0.2745	-0.0553

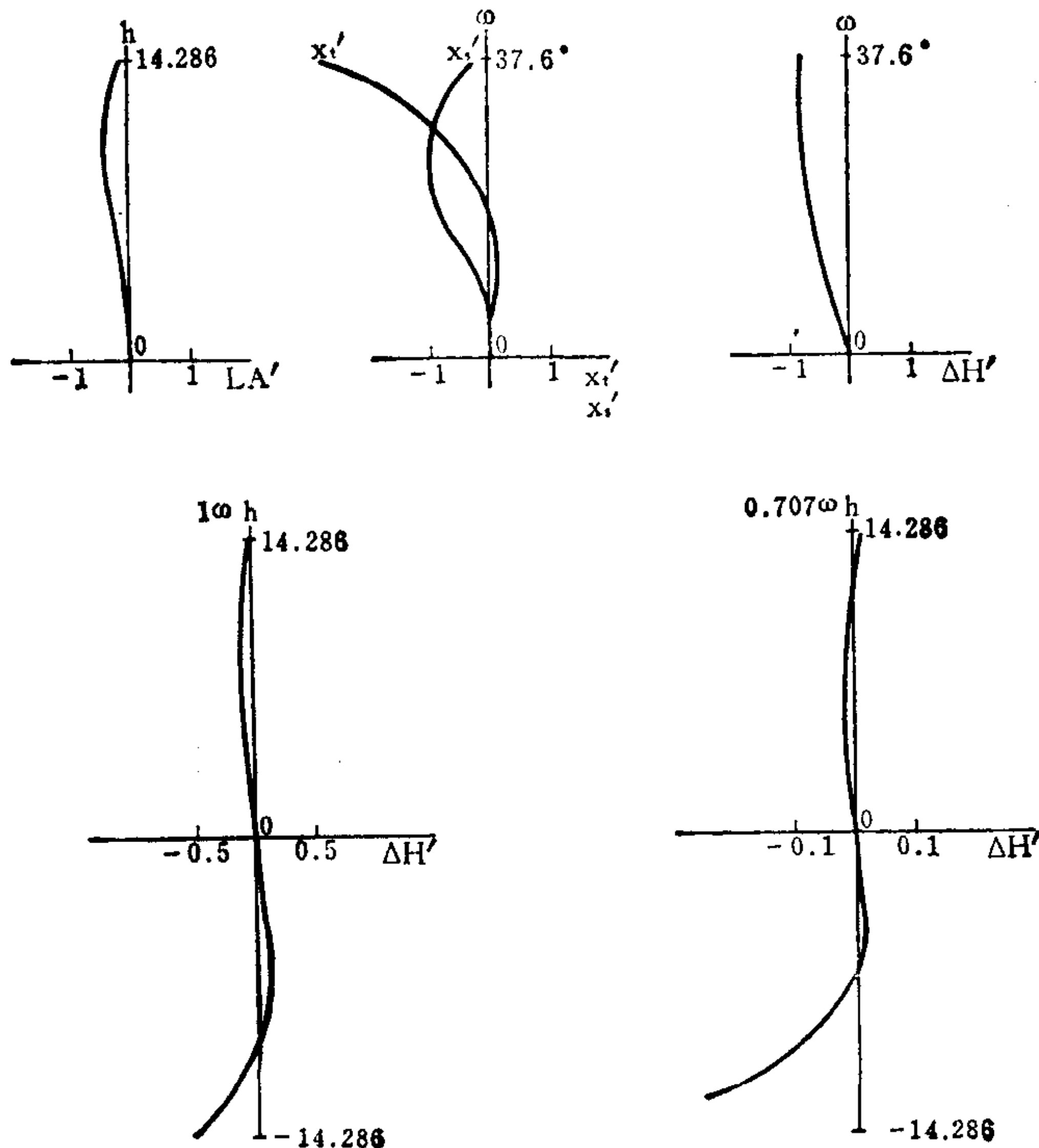

编号: 07-02-032

反远距型超广角照相物镜

E.F.L = 1

B.F.L = 1.488

FNo. = 2.8

F.A. = ±42°

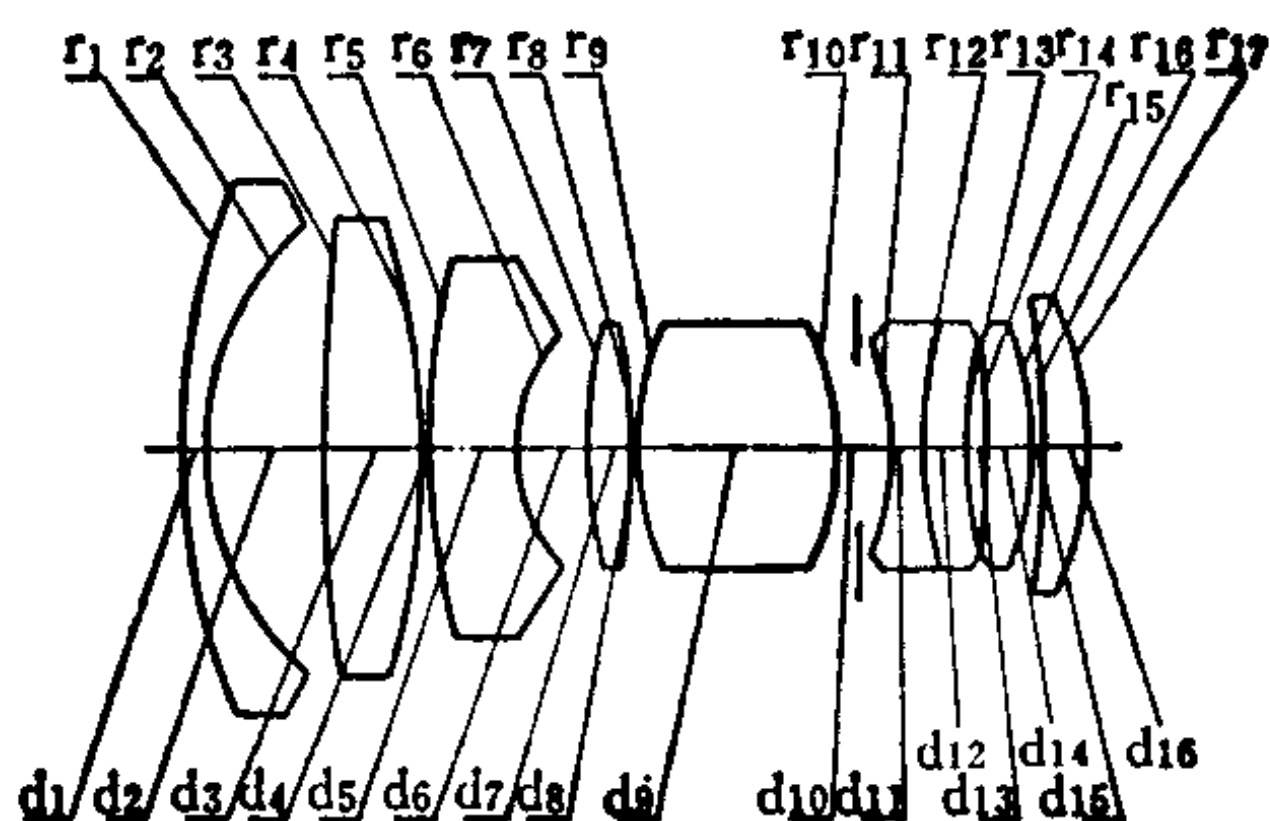

序号	r	d	n	v	序号	r	d	n	v
1	1.7432	0.0815	1.58913	61.0	10	-0.7111	0.1223*		
2	0.7914	0.3087			11	-0.8777	0.0979	1.80518	25.4
3	17.9249	0.2489	1.58913	61.0	12	2.4012	0.1019	1.72342	37.9
4	-2.8661	0.0408			13	1.5432	0.0489		
5	7.4418	0.2201	1.57957	53.7	14	-4.0265	0.1060	1.71300	53.9
6	0.4674	0.1857			15	-0.8657	0.0061		
7	1.8410	0.1142	1.80518	25.4	16	-4.2395	0.1101	1.71300	53.9
8	-9.2564	0.0041			17	-1.0165			
9	1.3639	0.5027	1.58913	61.0					

0.1223* = 0.0600 + 0.0623

	ΣS_1	ΣS_2	ΣS_3	ΣS_4	ΣS_5	HI	QP(1 ω)
	-0.001070	0.000038	0.000464	-0.001995	-0.009588	0.9	-0.88%
h 或 ω %	LA'	$\Delta H'$	x'_t	x'_s	$x'_t - x'_s$	K'_{T1}	$K'_{T0.7}$
100	-0.00439	-0.00794	-0.02580	0.00616	-0.03196	0.003034	0.000705
70	-0.00500	-0.01055	-0.00656	-0.01094	0.00438	-0.000877	-0.000045

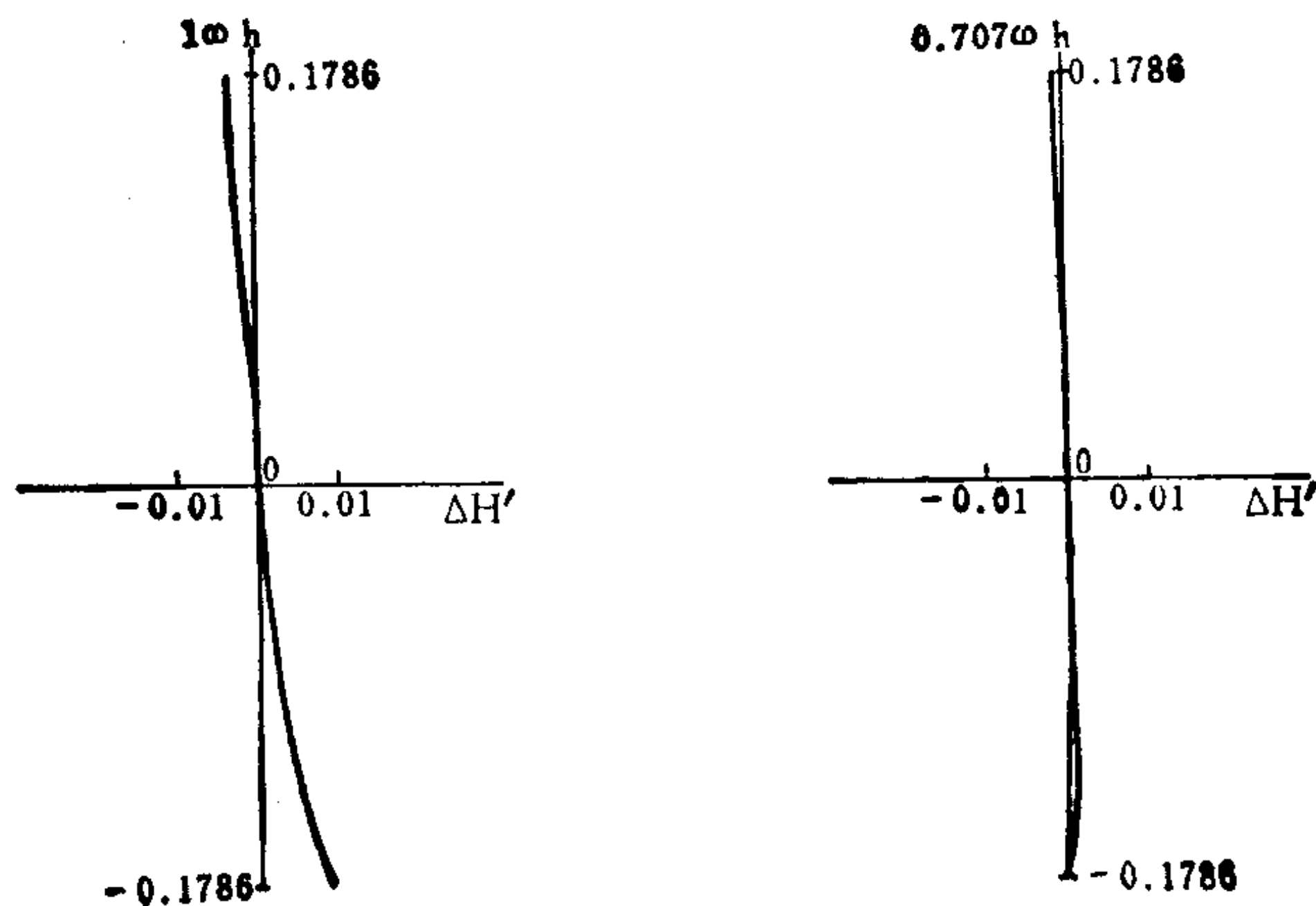
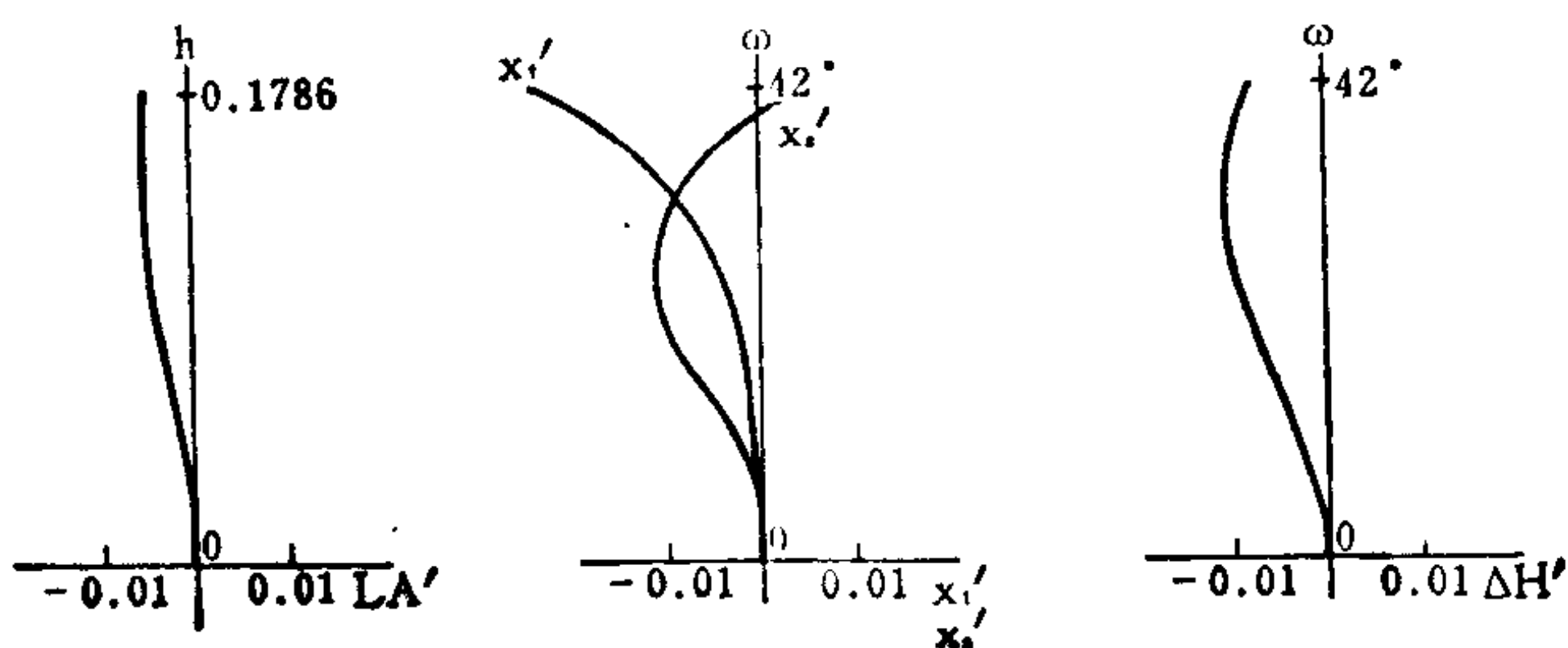

编号: 07-02-033

广 角 物 镜

E.F.L=12.7 B.F.L=6.8 FNo.=4 F.A.=±35°** L'p1=-2

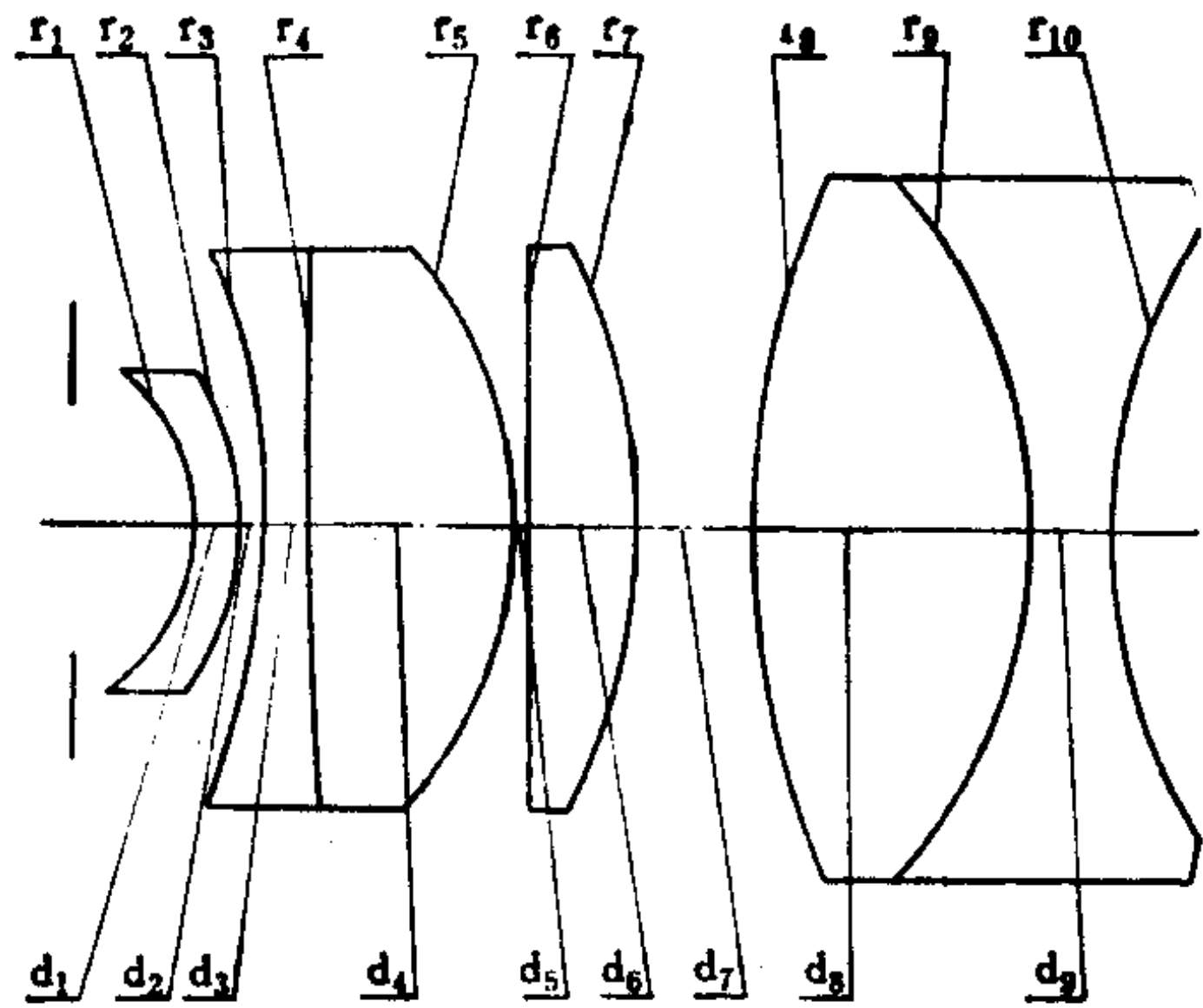

序号	r	d	n	v	序号	r	d	n	v
1	-4.10	1.0	1.73		6	∞	2.2	1.49	
2	-4.82	0.2			7	-12.88	2.2		
3	-15.38	1.0	1.73		8	15.30	6.0	1.62	
4	∞	4.2	1.62		9	-10.25	1.5	1.73	
5	-8.71	0.2			10	11.02			

	ΣS ₁	ΣS ₂	ΣS ₃	ΣS ₄	ΣS ₅	HI	QP(1ω)
	-0.02169	-0.01491	0.01098	-0.00792	-0.15192	8.8	-6.2%
h 或 ω %	LA'	ΔH'	x _t '	x _s '	x _t ' - x _s '	K _{T1} '	K _{T0.7} '
100	-0.694	-0.552	1.814	0.197	1.617	-0.1778	-0.0859
70	-0.346	-0.251	0.460	0.079	0.381	-0.1295	-0.0633

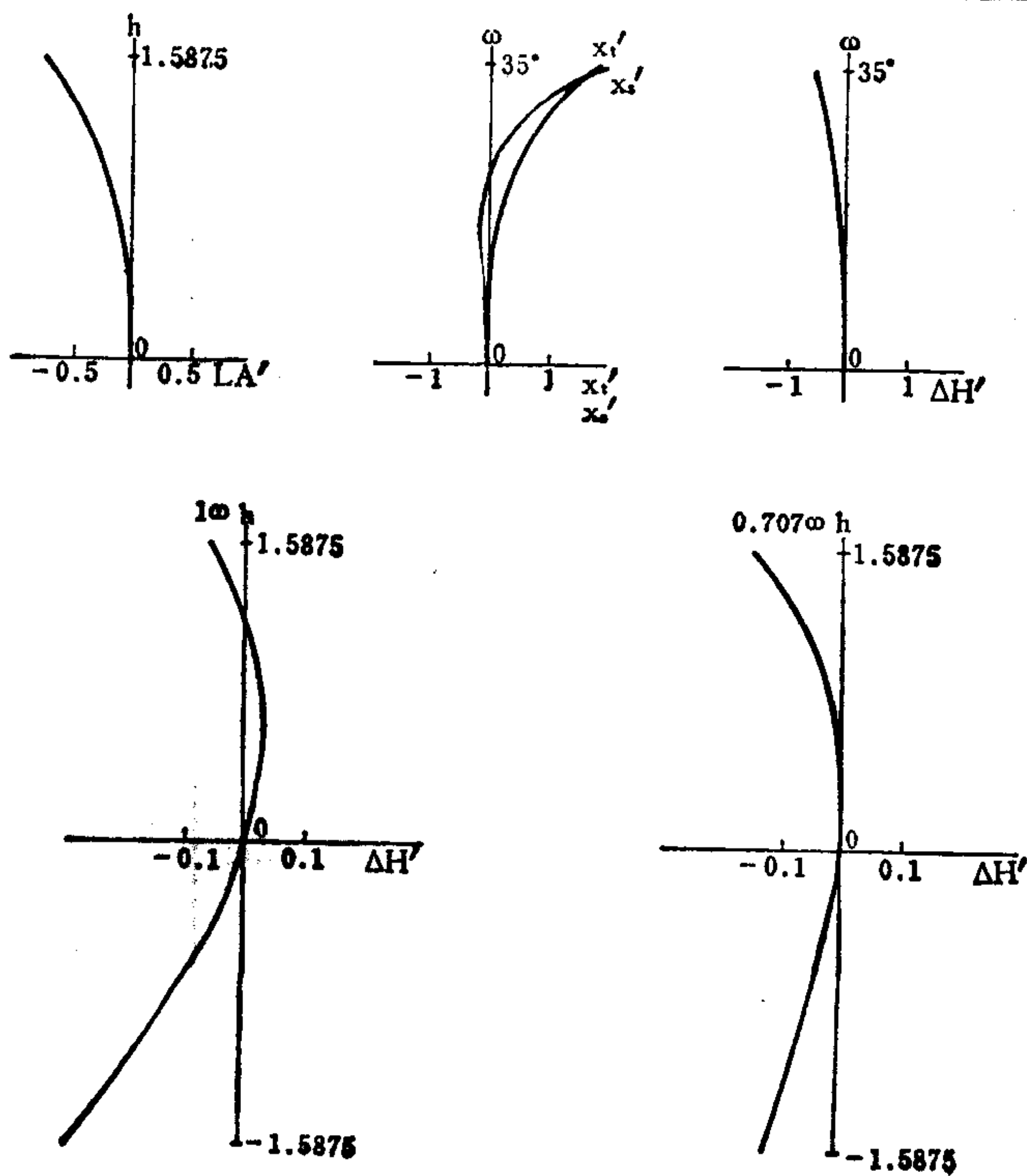

编号: 07-02-034

超广角大孔径物镜

E.F.L = 104.1

B.F.L = 199.6

FNo. = 2.08

F.A. = ±47.1°

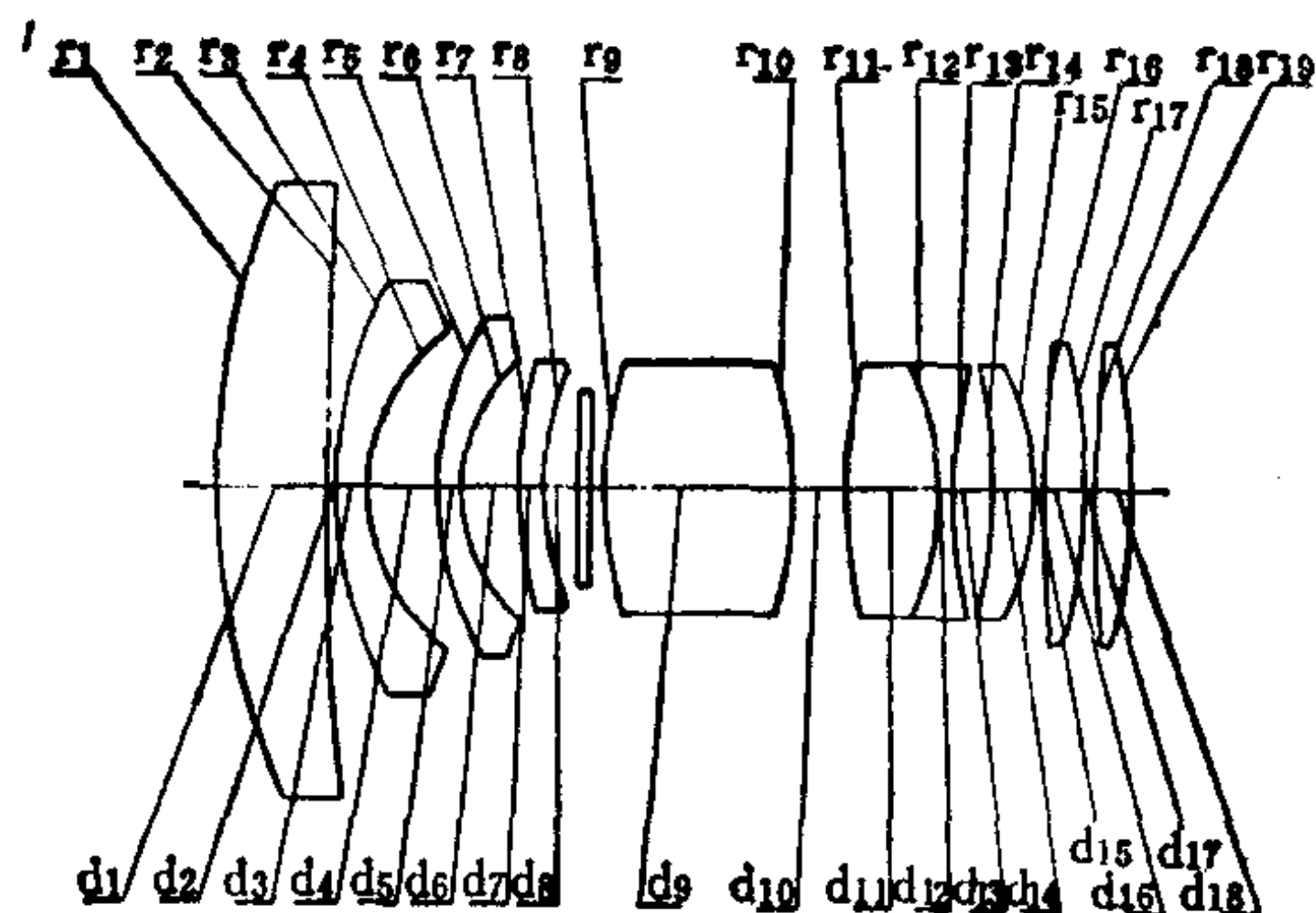

序号	r	d	n	v	序号	r	d	n	v
1	339.720	49.41	1.64000	60.2	10	-272.635	28.77*		
2	952.881	0.49			11	857.551	33.97	1.64000	60.2
3	218.581	9.95	1.74320	49.4	12	-126.036	4.85	1.84666	23.9
4	93.059	32.61			13	276.629	14.56		
5	162.580	8.74	1.51821	65.0	14	-766.797	17.62	1.51821	65.0
6	76.282	24.31			15	-124.736	0.49		
7	213.538	8.74	1.74320	49.4	16	5992.735	17.96	1.74320	49.4
8	97.733	26.69			17	-233.291	0.49		
	∞			滤色片	18	5117.276	13.54	1.69680	55.5
	∞				19	-384.364			
9	202.478	81.34	1.78470	26.2					

28.77° = 14.40 + 14.37

	ΣS ₁	ΣS ₂	ΣS ₃	ΣS ₄	ΣS ₅	HI	QP(1ω)
	0.0715	-0.0488	0.0191	-0.2503	-2.3244	112	-3.2%
h 或 ω%	LA'	ΔH'	x _i '	x _s '	x _i ' - x _s '	K _{T1}	K _{T0.7}
100	6.206	-3.641	-2.369	1.321	-3.690	-0.1887	-0.1018
70	1.384	-2.589	-1.433	-1.097	-0.336	0.0977	0.0011

注: 1. 以上象差值计算时, 未考虑滤色片。

2. 滤色片的基底玻璃是K9, d = 7.28。

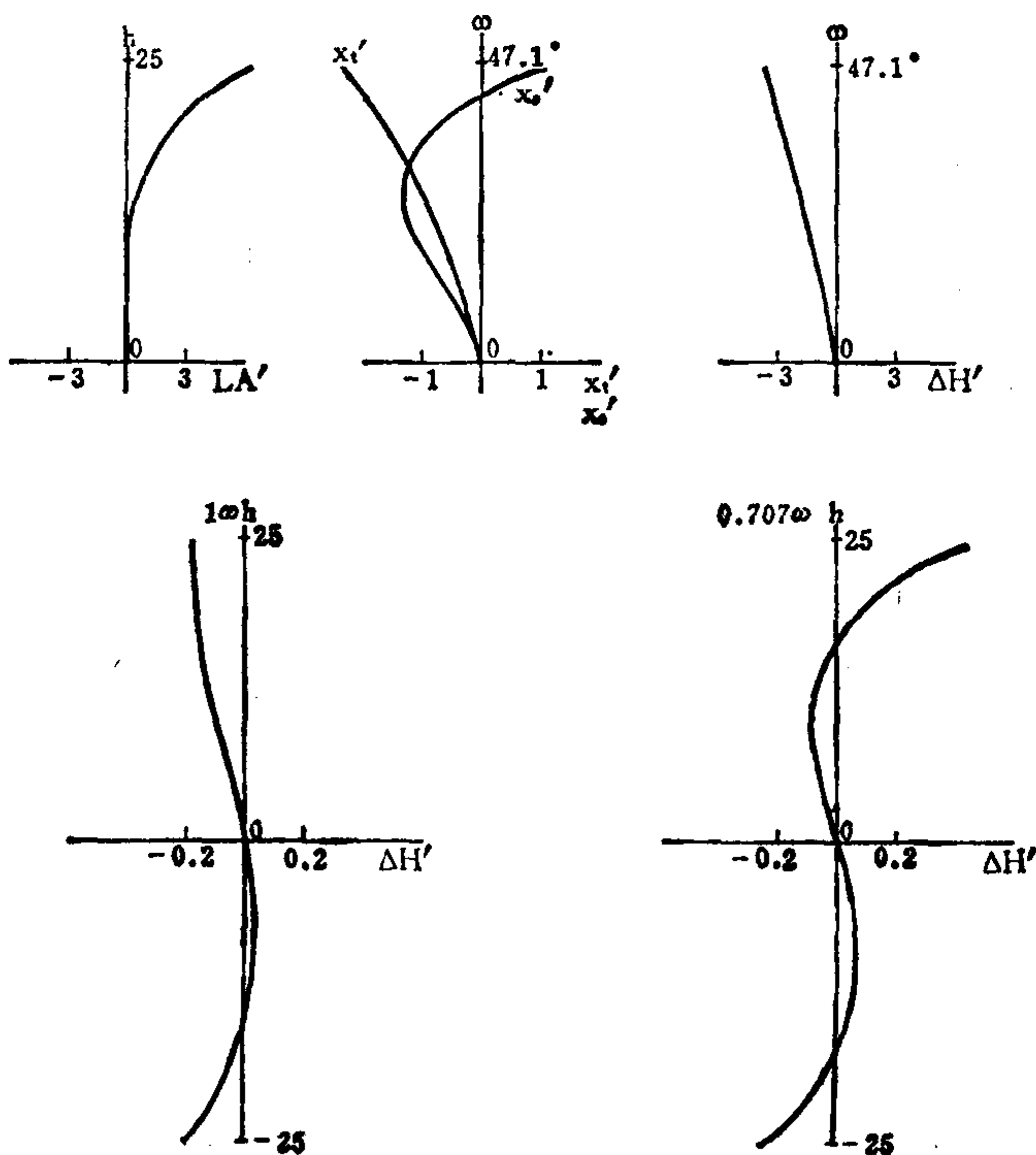

编号: 07-02-035

超广角大孔径物镜

E.F.L = 104.4

B.F.L = 206.2

FNo. = 2.09

F.A. = ±47.1°

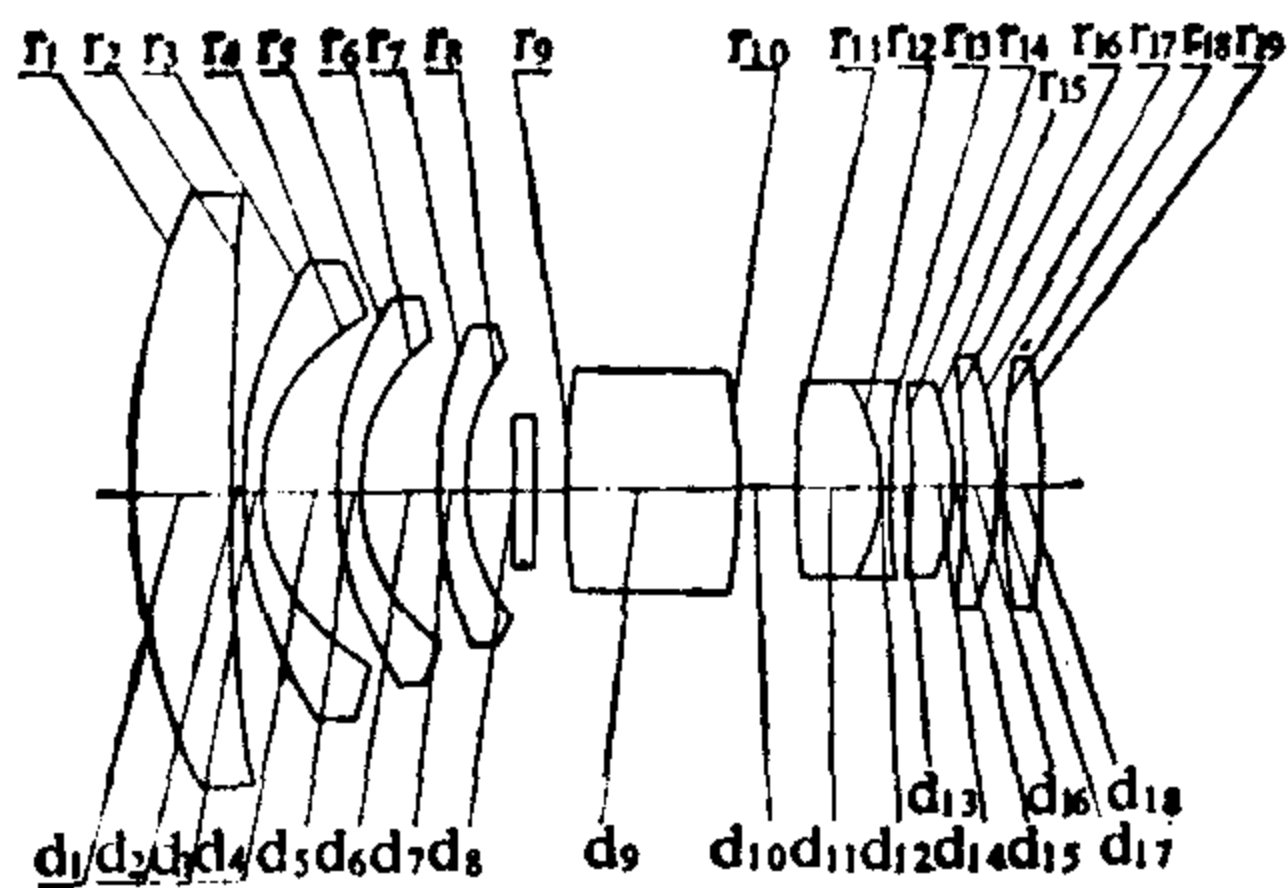

序号	r	d	n	v	序号	r	d	n	v
1	365.854	46.49	1.48749	70.1	10	-253.545	25.24*		
2	1140.959	1.08			11	578.573	39.79	1.64000	60.2
3	174.465	9.73	1.83400	37.2	12	-108.865	6.49	1.84666	23.9
4	94.271	36.93			13	252.722	10.96		
5	186.957	8.65	1.61800	63.4	14	-479.719	18.71	1.48749	70.1
6	91.877	36.07			15	-123.940	0.54		
7	236.259	8.65	1.61800	63.4	16	-4178.124	15.78	1.57135	52.9
8	91.949	45.74			17	-206.188	1.08		
9	∞				18	540.043	16.44	1.53172	48.9
8	∞				19	-468.648			
9	219.886	82.50	1.80518	25.4					

25.24° = 13.00 + 12.24

	ΣS ₁	ΣS ₂	ΣS ₃	ΣS ₄	ΣS ₅	HI	QP(1ω)
	0.0877	-0.0513	0.0225	-0.2622	-2.1657	112.4	-4.5%
h 或 ω %	LA'	ΔH'	x _t '	x _s '	x _t ' - x _s '	K _{t1}	K _{t0.7}
100	8.099	-5.071	-1.812	-0.785	-1.027	-0.2311	-0.1148
70	1.735	-2.508	-1.342	-1.246	-0.096	-0.0763	-0.0366

注: 1. 以上象差值计算时, 未考虑滤色片。
2. 滤色片的基底玻璃是K9, d = 8.11.

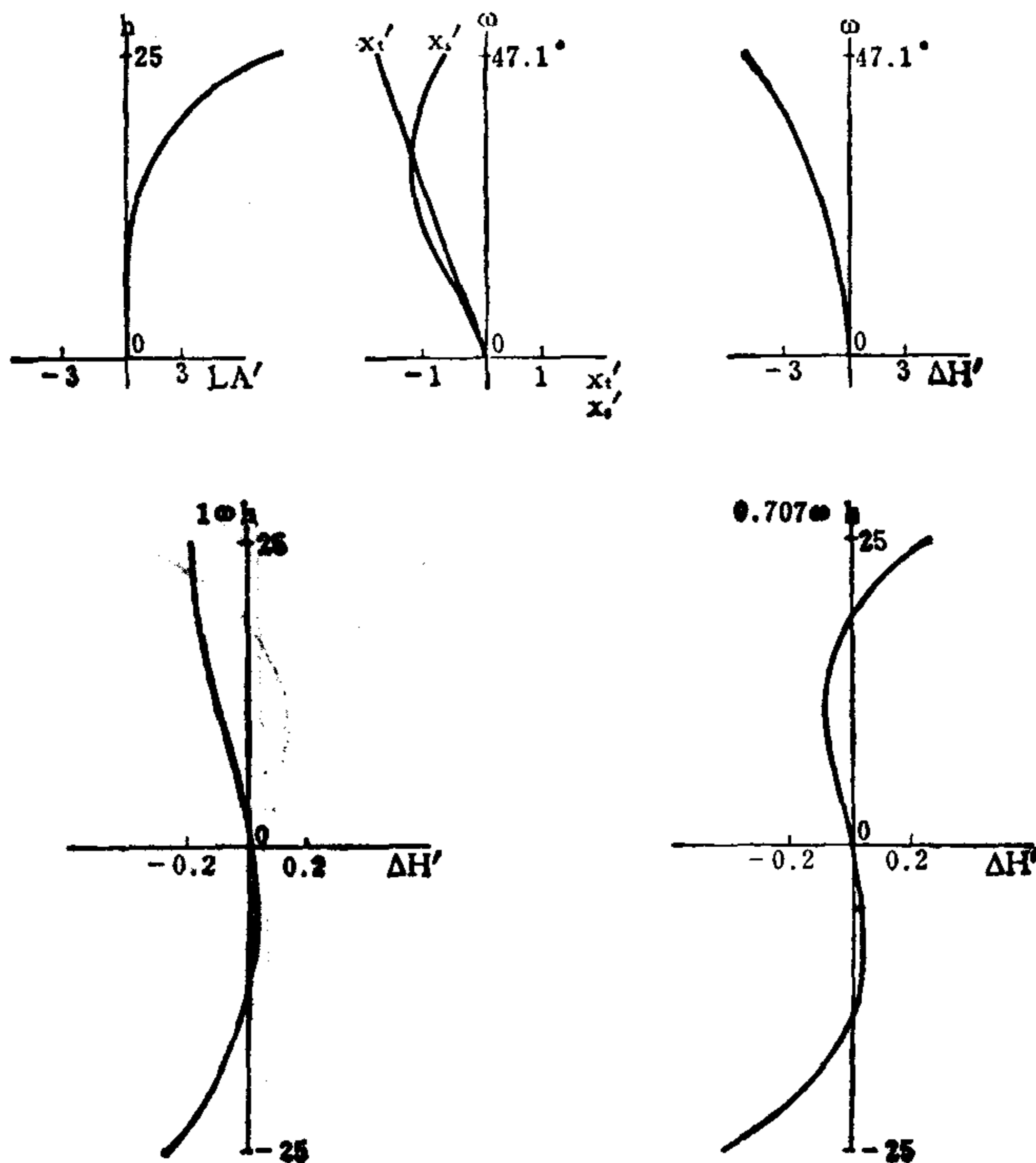

编号: 07-02-036

反远距型广角大孔径物镜

E.F.L = 100

B.F.L = 134.7

FNo. = 2

F.A. = ± 37°

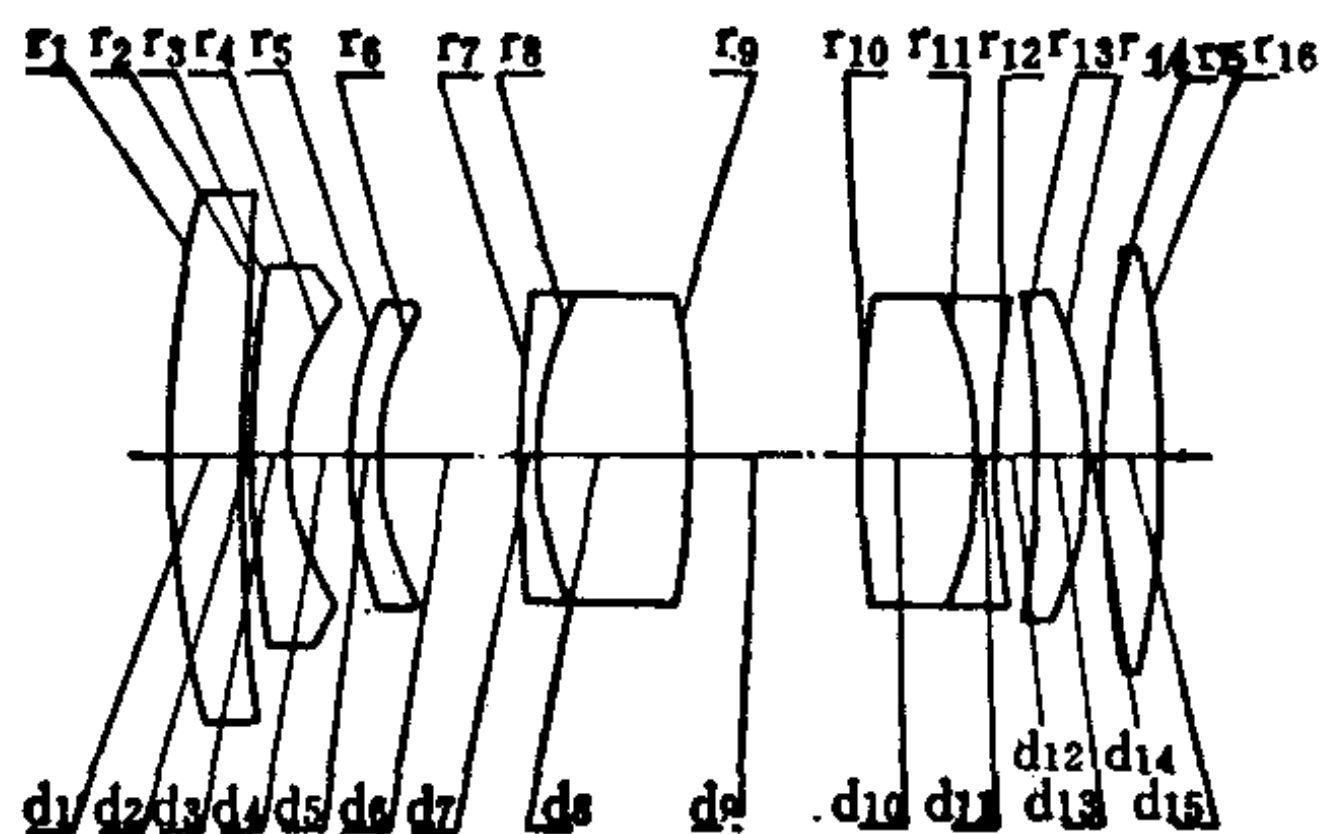

序号	r	d	n	v	序号	r	d	n	v
1	146.803	15.86	1.64000	60.3	9	-6140.173	17.07*		
2	637.795	0.53			10	897.850	21.51	1.79952	42.3
3	193.755	5.20	1.50378	66.8	11	-72.551	3.64	1.76182	26.6
4	44.149	13.02			12	177.680	6.73		
5	81.596	7.11	1.50378	66.8	13	-159.677	10.47	1.69680	55.6
6	54.975	27.48			14	-71.340	0.53		
7	306.164	3.51	1.50378	66.8	15	238.752	10.71	1.69680	55.6
8	67.153	31.31	1.72000	43.7	16	-267.319			

17.07* = 8.50 + 8.57

	ΣS_1	ΣS_2	ΣS_3	ΣS_4	ΣS_5	HI	QP(1 ω)
	-0.2506	0.1163	-0.0066	-0.2880	-1.1858	75.3	-2.4%
h 或 ω %	LA'	$\Delta H'$	x'_t	x'_s	$x'_t - x'_s$	K'_{T1}	$K'_{T0.7}$
100	0.283	-1.818	-1.500	-0.063	-1.437	-0.1762	-0.0521
70	-0.493	-0.982	-0.654	-0.822	0.168	-0.2769	-0.0142

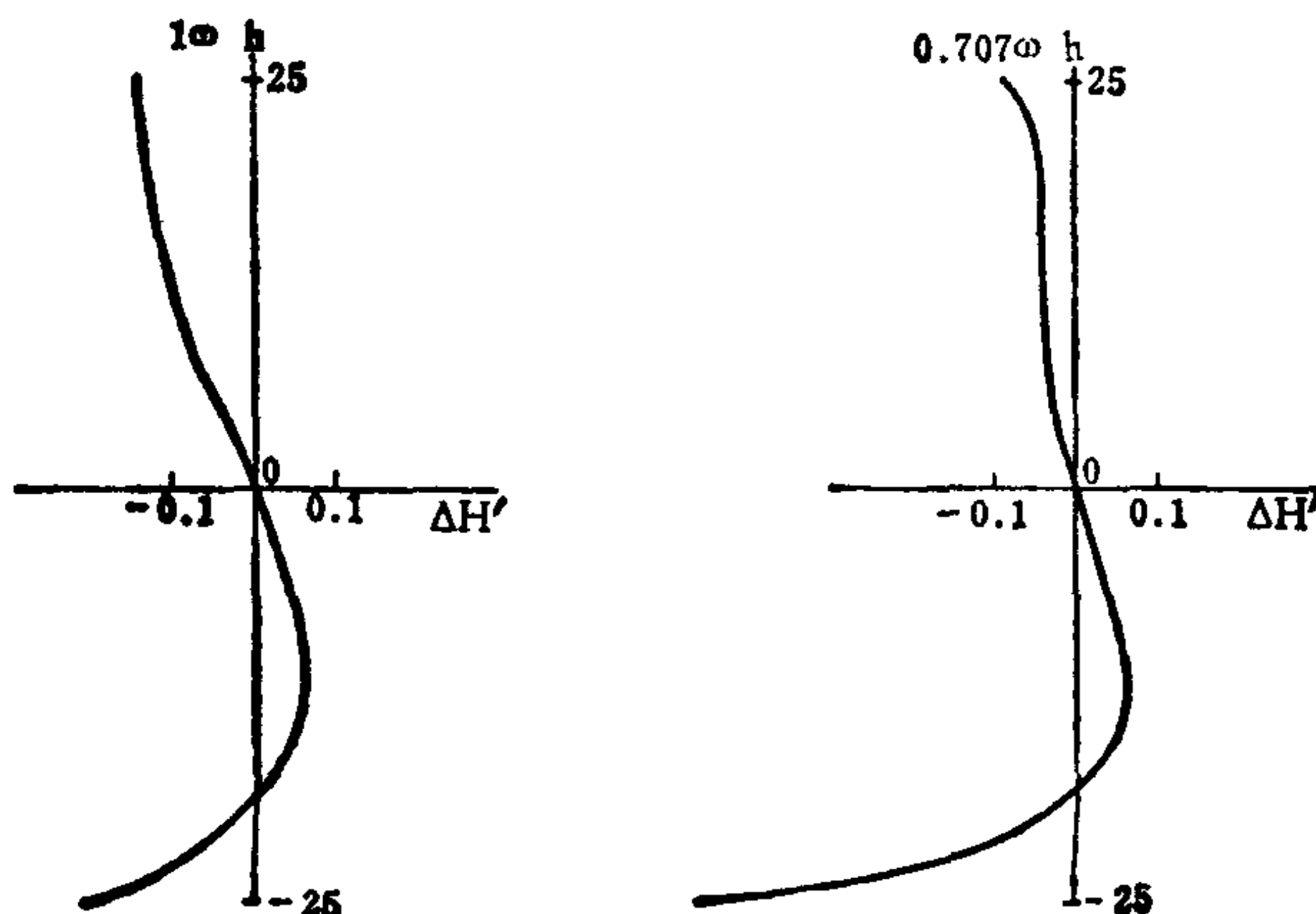
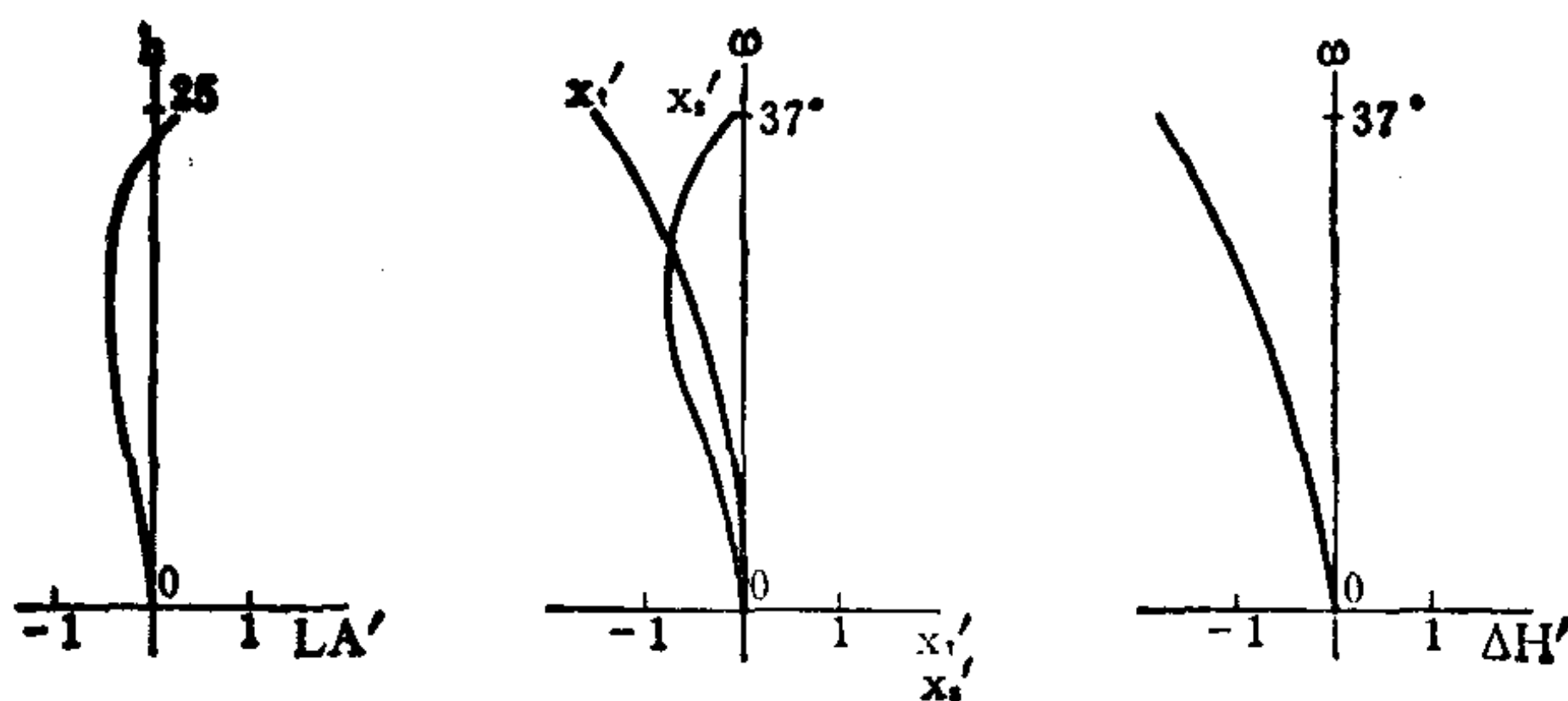

编号: 07-02-037

反远距型广角大孔径物镜

E.F.L=100

B.F.L=134.5

FNo.=2

F.A.=±37°

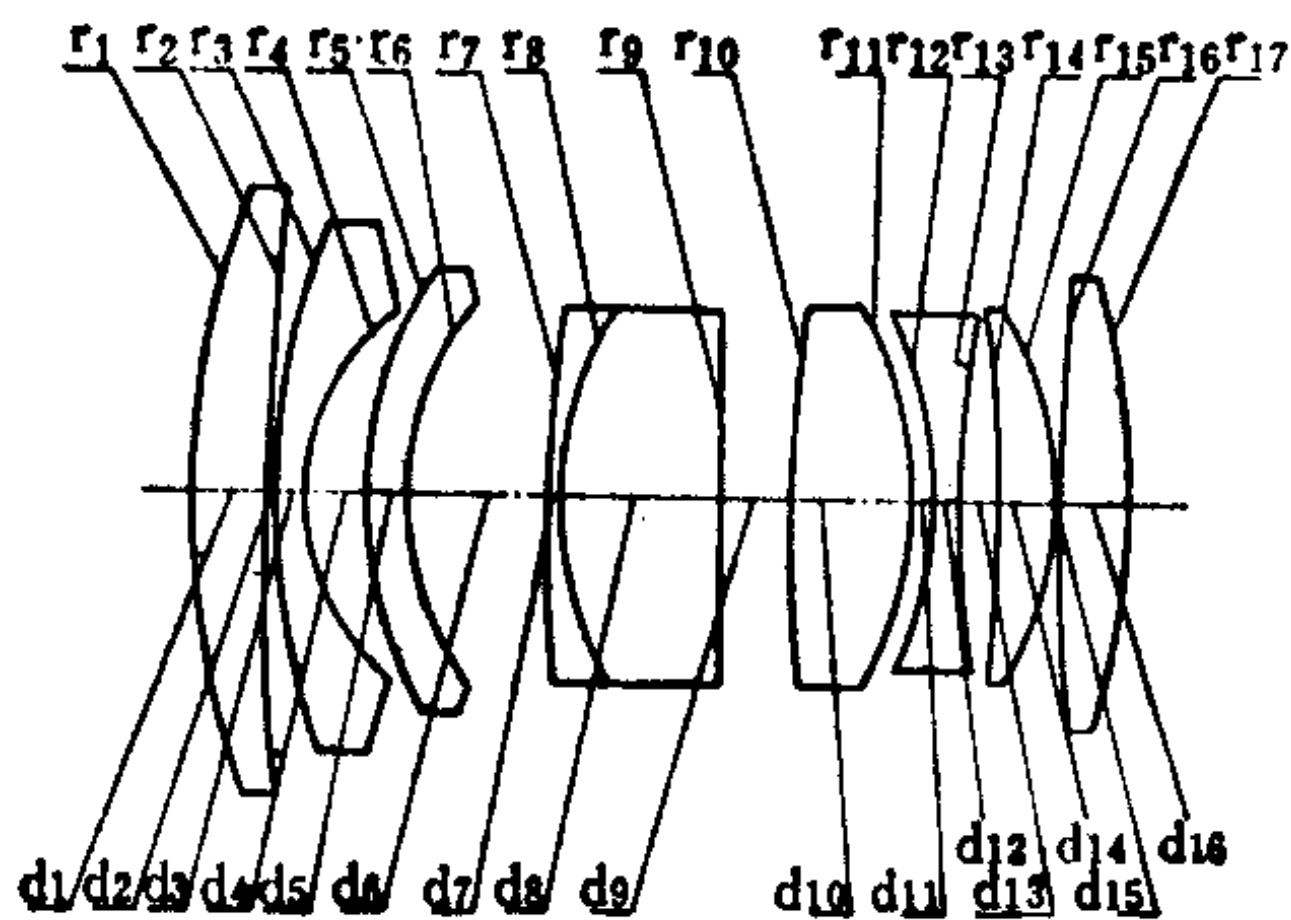

序号	r	d	n	v	序号	r	d	n	v
1	152.802	15.74	1.64000	60.3	10	3194.398	21.77	1.78800	47.5
2	651.702	0.53			11	-82.032	4.58		
3	184.493	5.00	1.50378	66.8	12	-75.997	3.79	1.76182	26.6
4	43.128	13.30			13	223.486	6.63		
5	80.507	7.31	1.50378	66.8	14	-233.989	10.43	1.69680	55.6
6	55.504	27.73			15	-74.255	0.53		
7	329.365	3.72	1.50378	66.8	16	447.901	10.04	1.69680	55.6
8	67.631	31.60	1.72000	46.0	17	-187.702			
9	∞	13.76*							

$13.76^* = 7.00 + 6.76$

	ΣS_1	ΣS_2	ΣS_3	ΣS_4	ΣS_5	HI	QP (1 ω)
	-0.2849	0.1032	-0.0078	-0.2598	-1.1749	75.3	-2.2%
h 或 ω %	LA'	$\Delta H'$	x'_t	x'_s	$x'_t - x'_s$	K'_{T1}	$K'_{T0.7}$
100	0.176	-1.650	-1.343	-0.038	-1.305	-0.1854	-0.0483
70	-0.490	-0.950	-0.676	-0.759	0.083	-0.3319	-0.0306

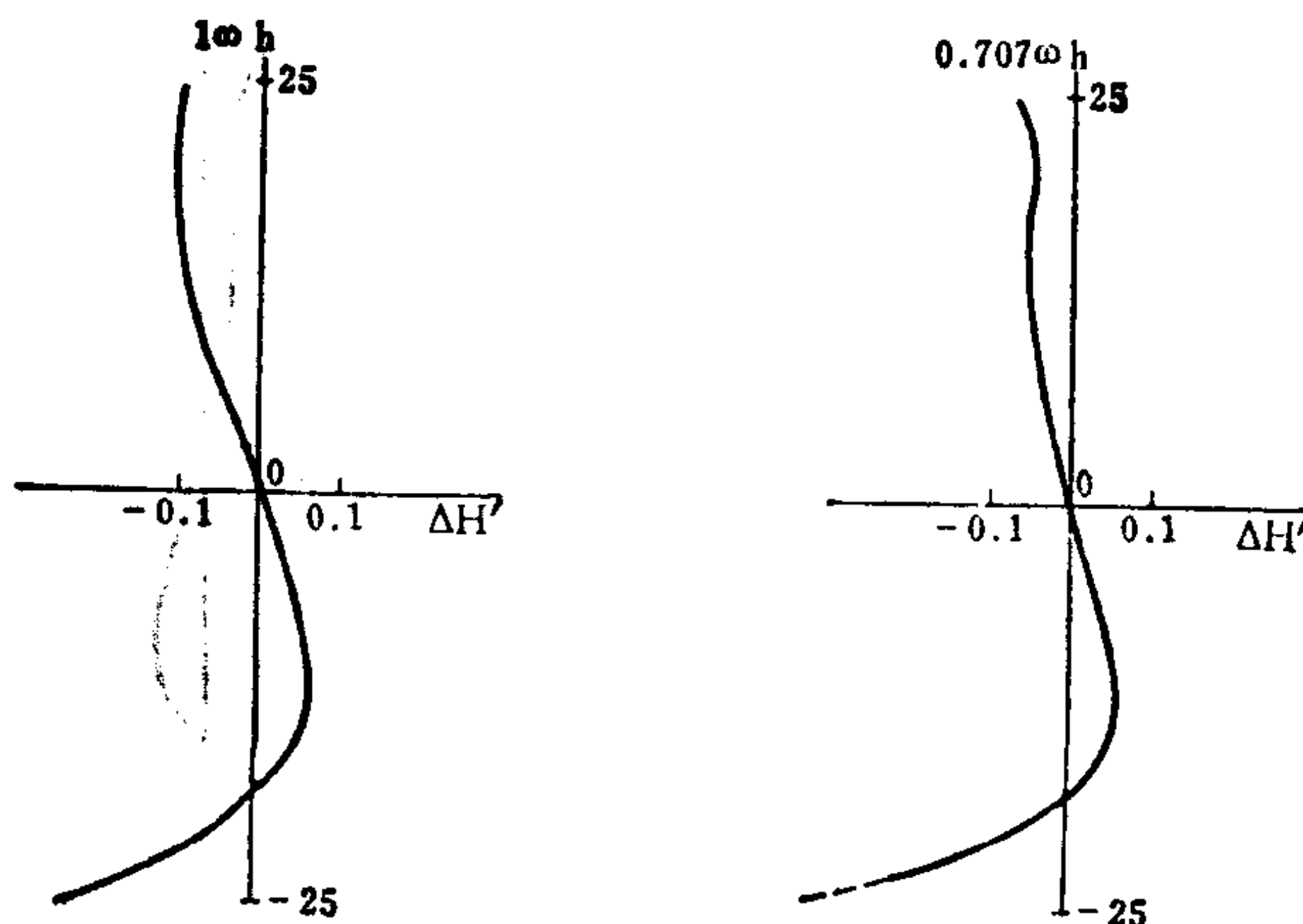
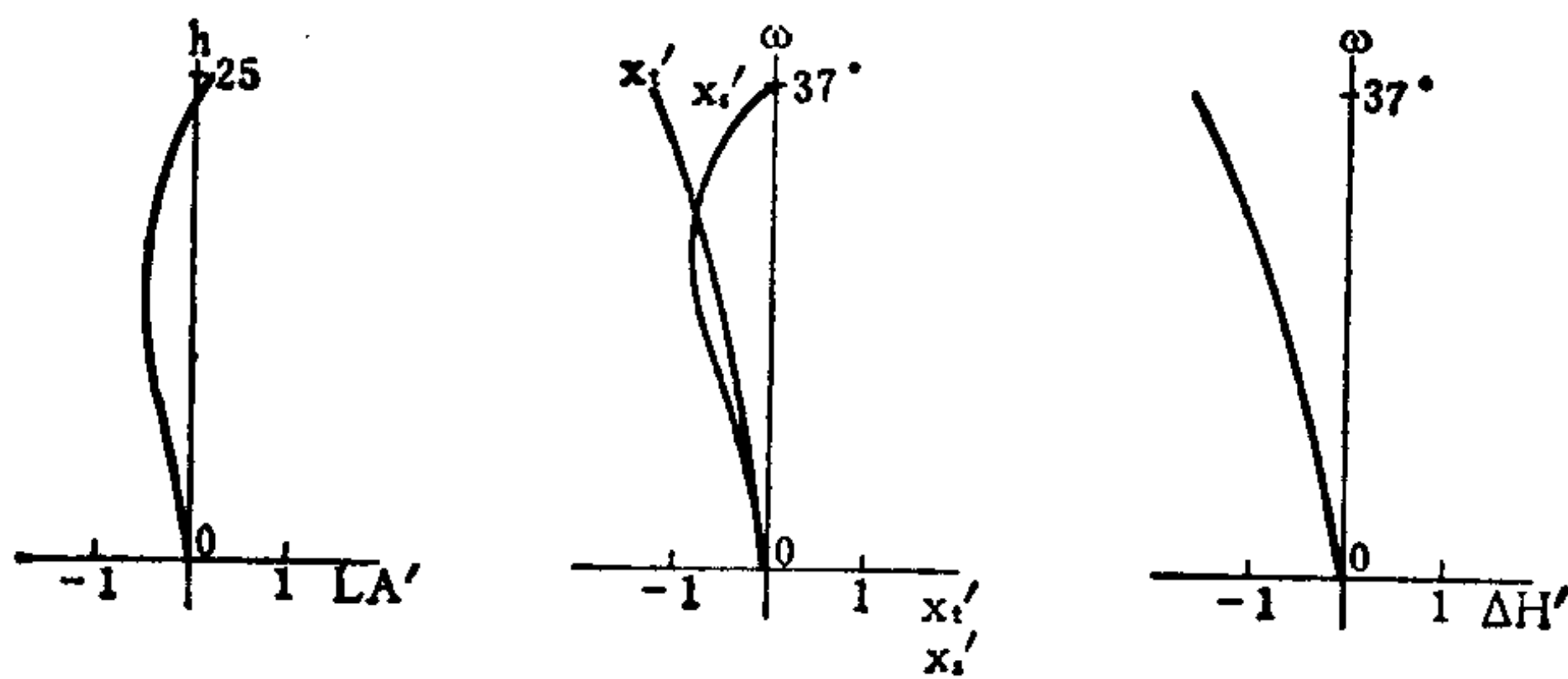

编号: 07-02-038

广角照相物镜

E.F.L = 100

B.F.L = 127.64

FNo. = 2

F.A. = $\pm 37.5^\circ$

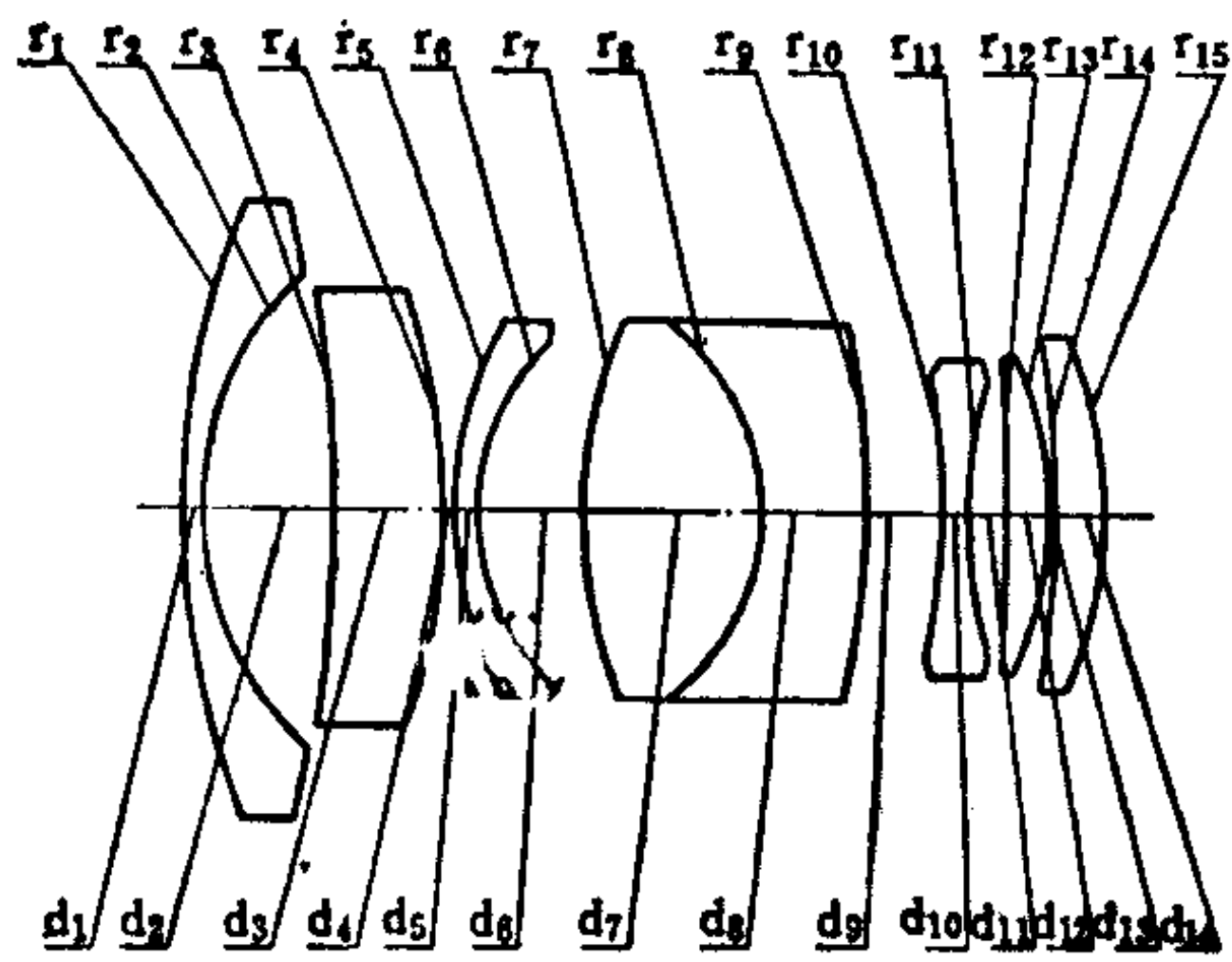

序号	r	d	n	v	序号	r	d	n	v
1	199.730	4.126	1.49831	65.0	9	-196.956	17.754*		
2	68.296	30.168			10	-124.352	4.161	1.84666	23.9
3	-305.836	24.273	1.68250	44.7	11	146.676	8.461		
4	-206.318	3.710			12	-274.954	8.842	1.73400	51.5
5	85.301	4.161	1.71300	53.9	13	-77.738	0.347		
6	52.914	23.683			14	-1074.933	9.536	1.71300	53.9
7	104.026	38.455	1.80610	40.9	15	-115.465			
8	-52.914	24.481	1.72342	38.0					

$17.754^* = 8.000 + 9.754$

	ΣS_1	ΣS_2	ΣS_3	ΣS_4	ΣS_5	HI	QP(1 ω)
	-0.38299	0.09468	0.07912	-0.38976	-1.00043	76.7	-1.9%
h 或 ω %	LA'	$\Delta H'$	x'_t	x'_s	$x'_t - x'_s$	K'_{T1}	$K'_{T0.7}$
100	-1.227	-1.522	-1.582	0.170	-1.752	0.5740	-0.2701
70	-0.372	-0.796	-0.569	-0.982	0.413	-0.3702	-0.0974

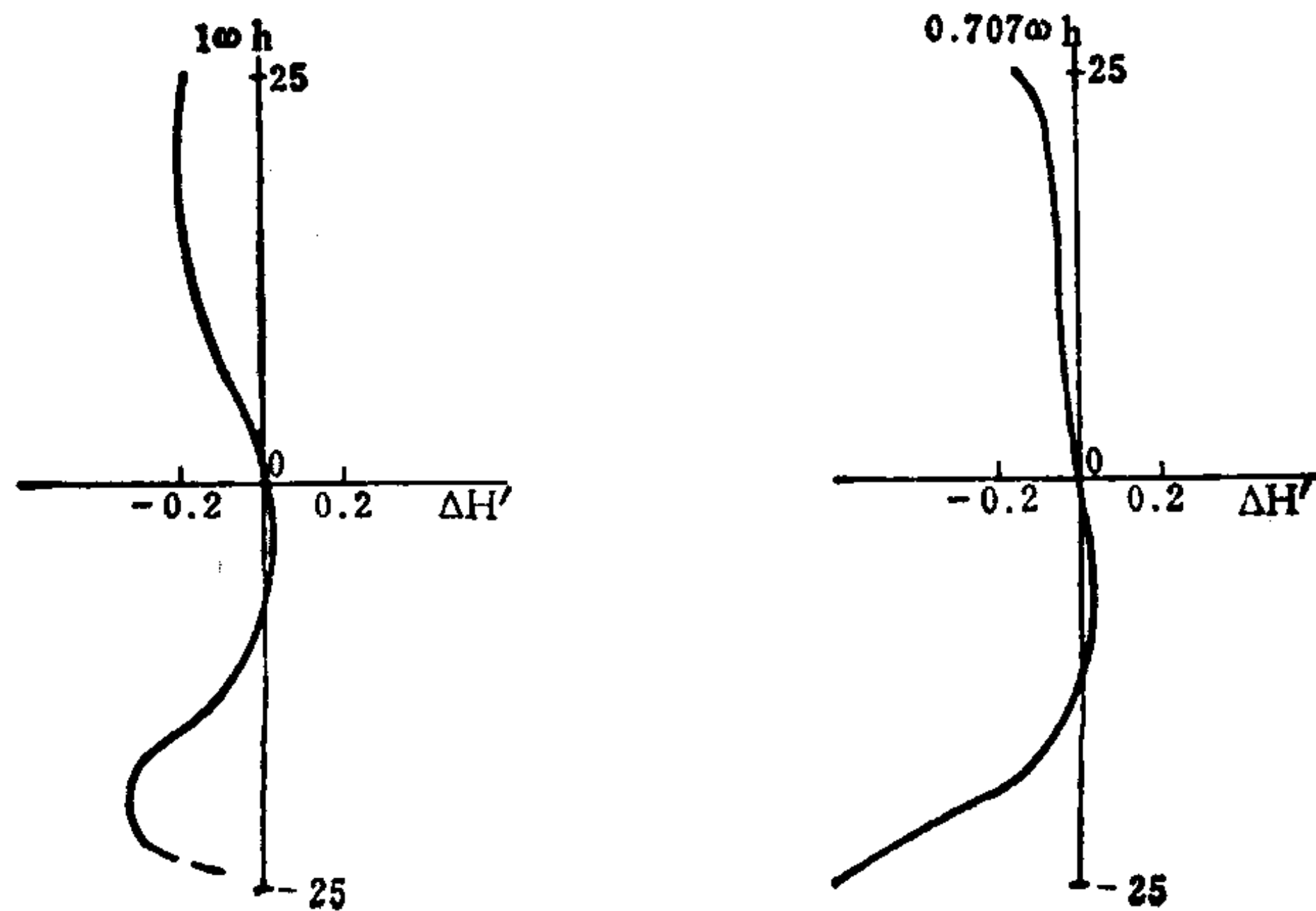
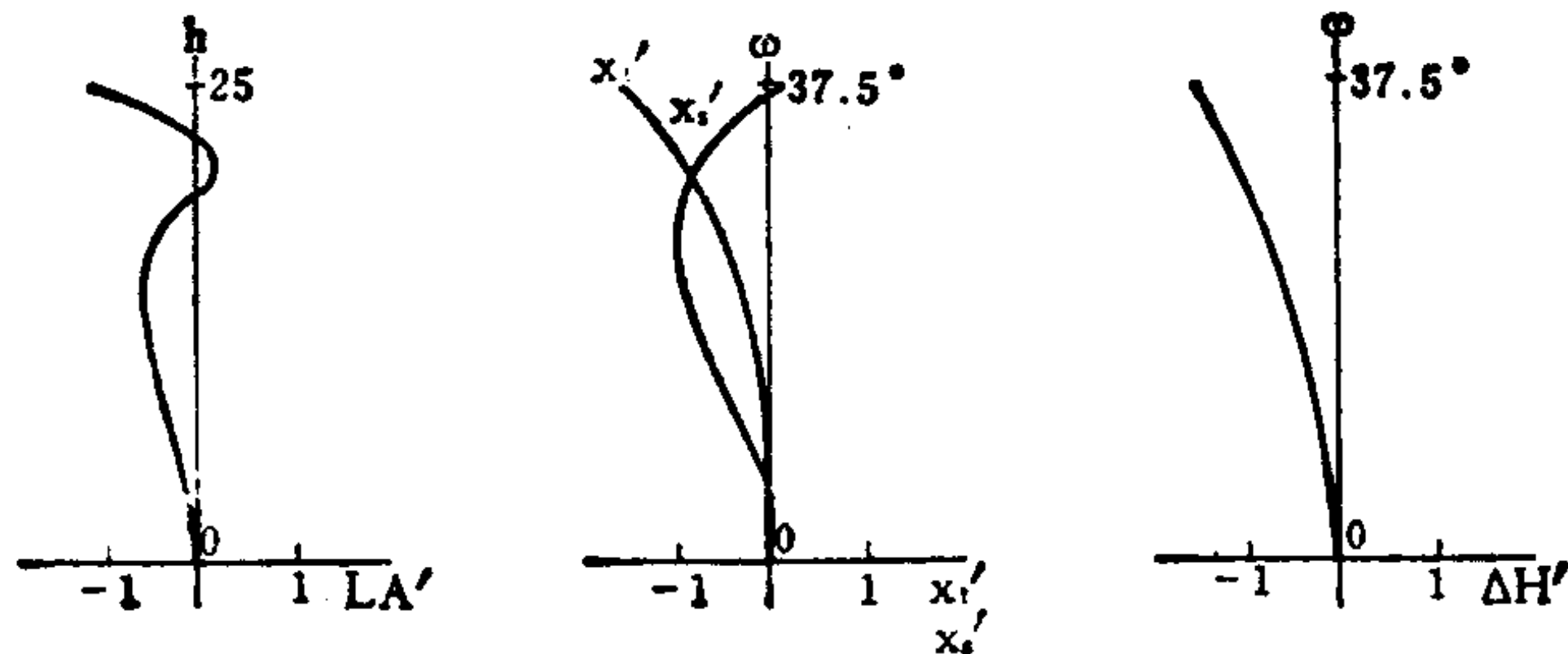

编号: 07-02-039

反远距型广角物镜

E.F.L=1

B.F.L=1.32

FNo.=3.5

F.A.=±37.5°

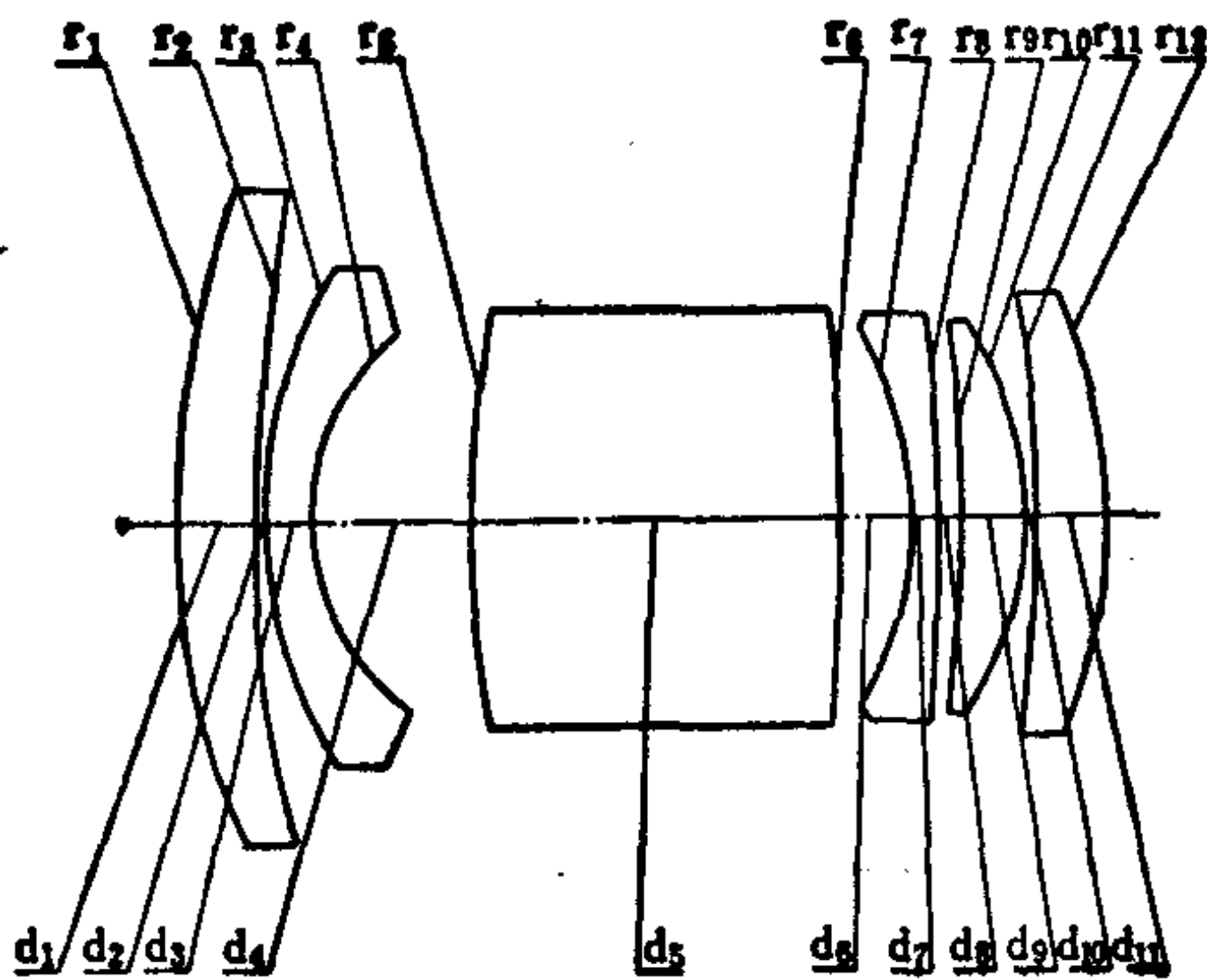

序号	r	d	n	v	序号	r	d	n	v
1	0.98629	0.10574	1.7432	49.4	7	-0.56679	0.04406	1.78472	25.7
2	2.18620	0.00353			8	-115.8307	0.02579		
3	0.64888	0.05287	1.51835	60.3	9	-2.28218	0.07190	1.67000	57.3
4	0.27280	0.19667			10	-0.44600	0.00353		
5	8.13576	0.45926	1.80518	25.4	11	-3.07504	0.07930	1.67000	57.3
6	-2.38235	0.07049*			12	-0.67634			

0.07049* = 0.01000 + 0.06049

	ΣS_1	ΣS_2	ΣS_3	ΣS_4	ΣS_5	HI	QP(1 ω)
	-0.000868	0.000377	0.000196	-0.001275	-0.005378	0.77	-2.4%
h 或 ω %	LA'	$\Delta H'$	x'_i	x'_s	$x'_i - x'_s$	K'_{T1}	$K'_{r0.7}$
100	-0.00128	-0.01874	-0.01443	-0.00456	-0.00987	-0.000209	-0.000134
70	-0.00682	-0.00790	-0.00587	-0.00965	0.00378	-0.000218	0.000014

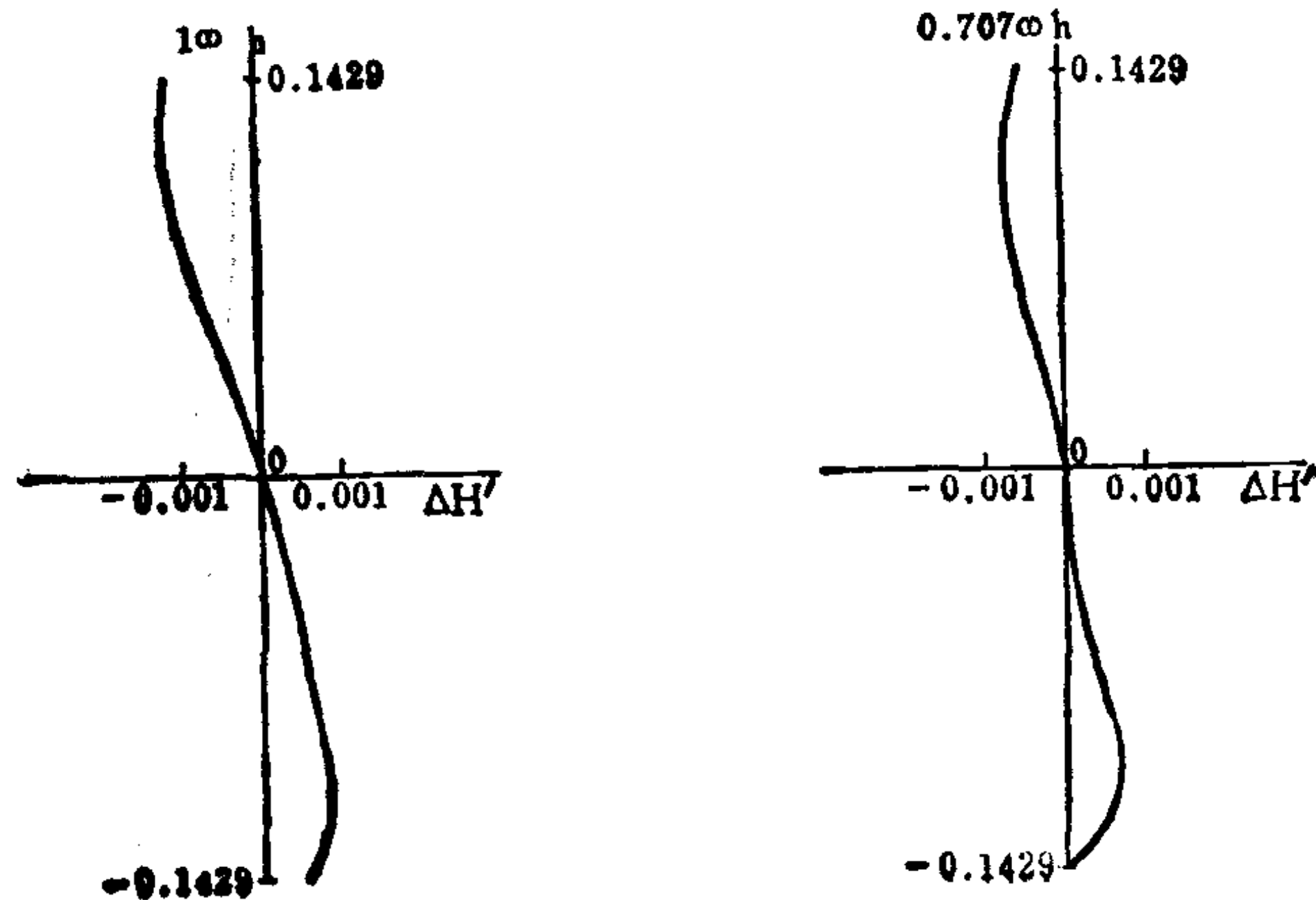
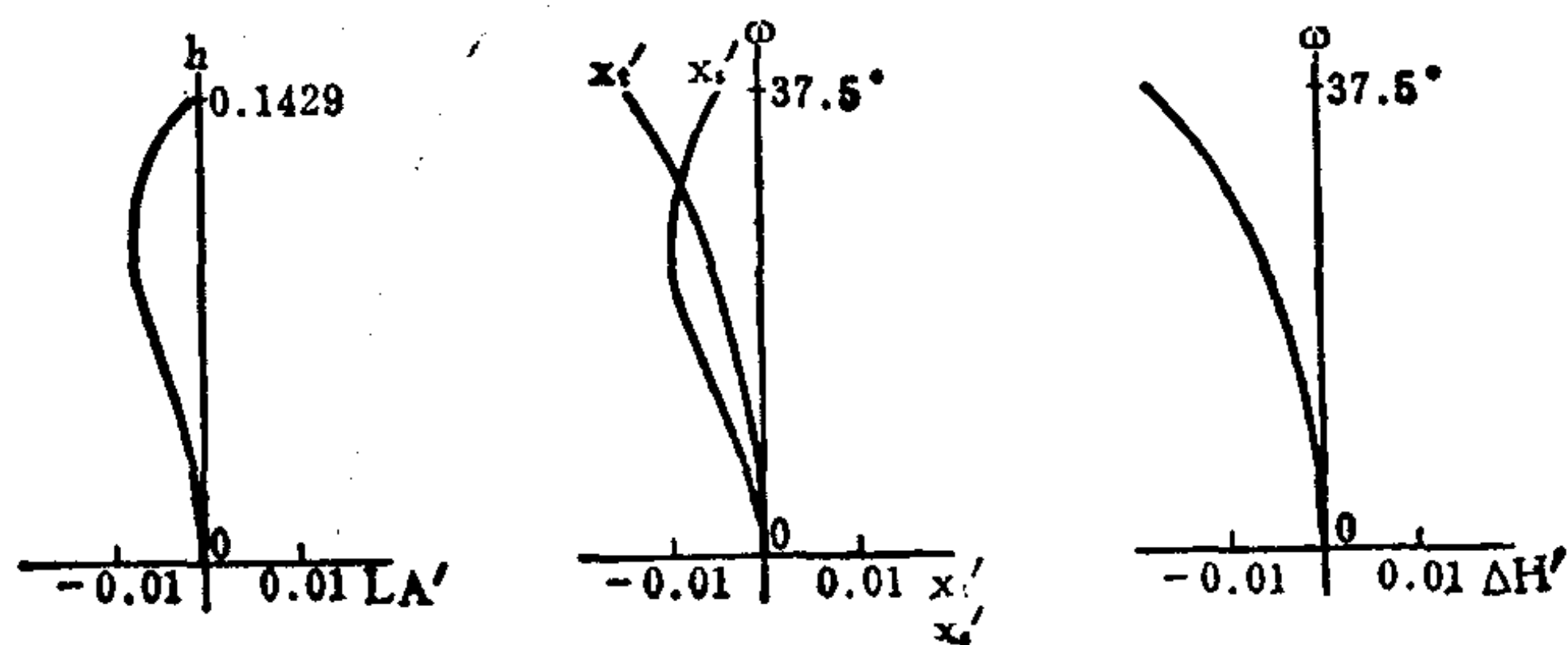

编号: 07-02-040

反远距型广角物镜

E.F.L = 1

B.F.L = 1.31586

FNo. = 3.5

F.A. = ± 37.5°

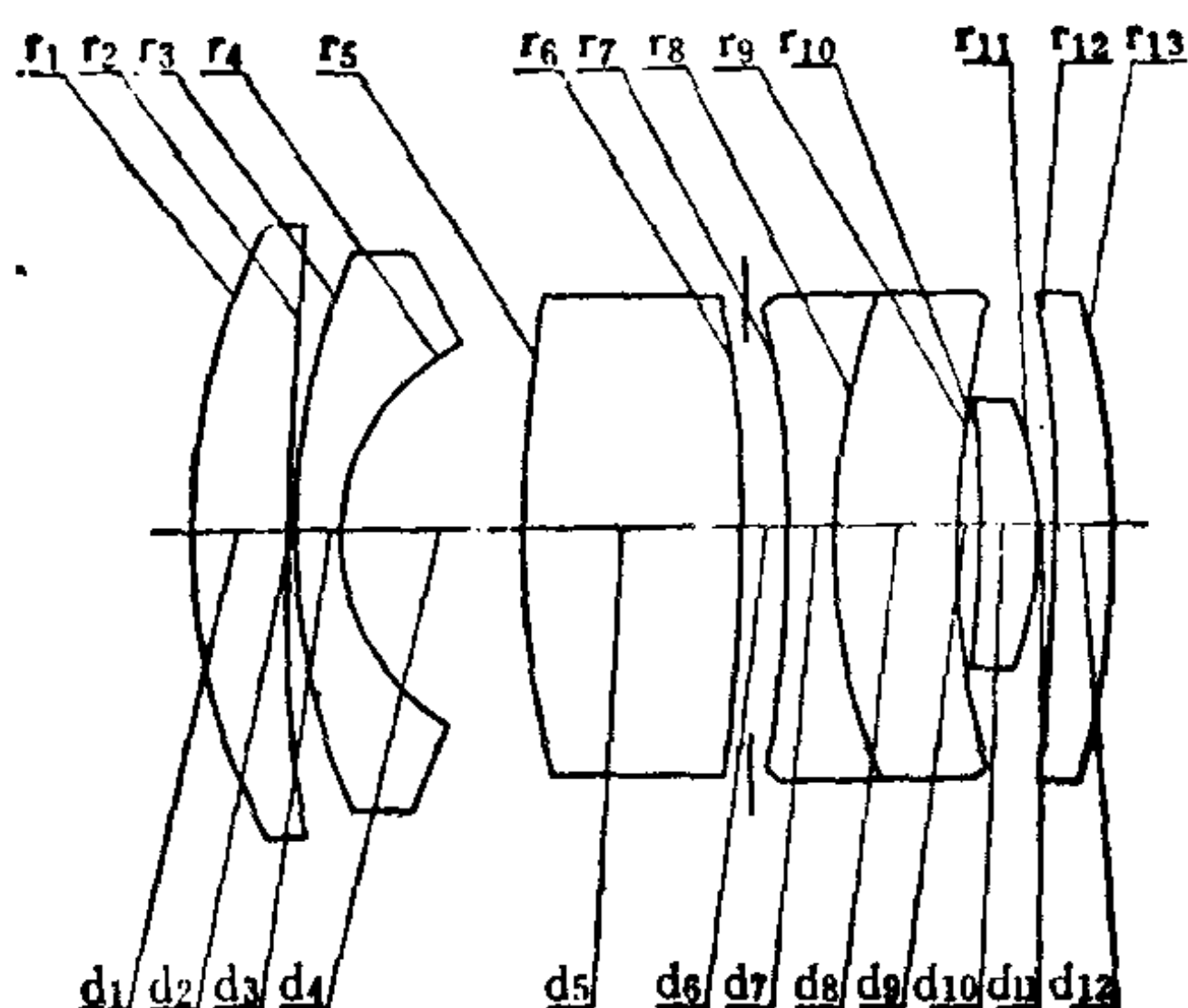

序号	r	d	n	v	序号	r	d	n	v
1	0.77899	0.10990	1.72000	43.7	8	0.79942	0.14716	1.78590	44.1
2	2.21704	0.00351			9	9.96285	0.01898		
3	0.99337	0.05263	1.51835	60.3	10	-1.94162	0.08362	1.67000	57.3
4	0.25837	0.21618			11	-0.45292	0.00351		
5	2.37382	0.25923	1.78472	25.7	12	-3.10087	0.07274	1.67000	57.3
6	-19.16816	0.06070*			13	-1.06628			
7	-1.31411	0.05263	1.78472	25.7					

0.06070* = 0.01000 + 0.05070

	ΣS_1	ΣS_2	ΣS_3	ΣS_4	ΣS_5	HI	QP(1 ω)
	-0.001006	0.000191	0.000168	-0.000959	-0.006046	0.76	-2%
h 或 ω %	LA'	$\Delta H'$	x'_t	x'_s	$x'_t - x'_s$	K'_{T1}	$K'_{T0.7}$
100	-0.00076	-0.01561	-0.01157	-0.00261	-0.00896	-0.000400	-0.000347
70	-0.00775	-0.00840	-0.00596	-0.00785	0.00189	0.000040	-0.000003

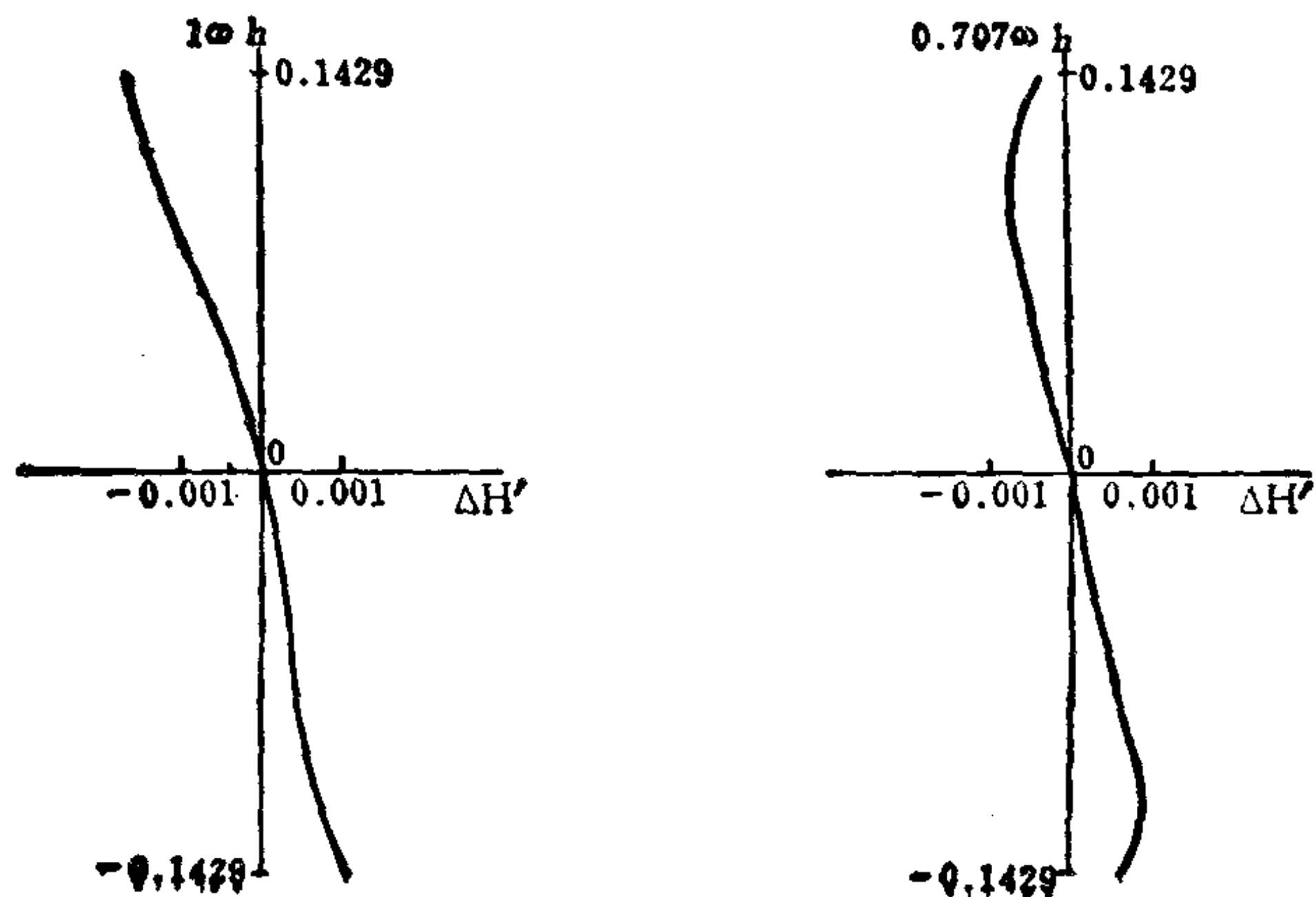
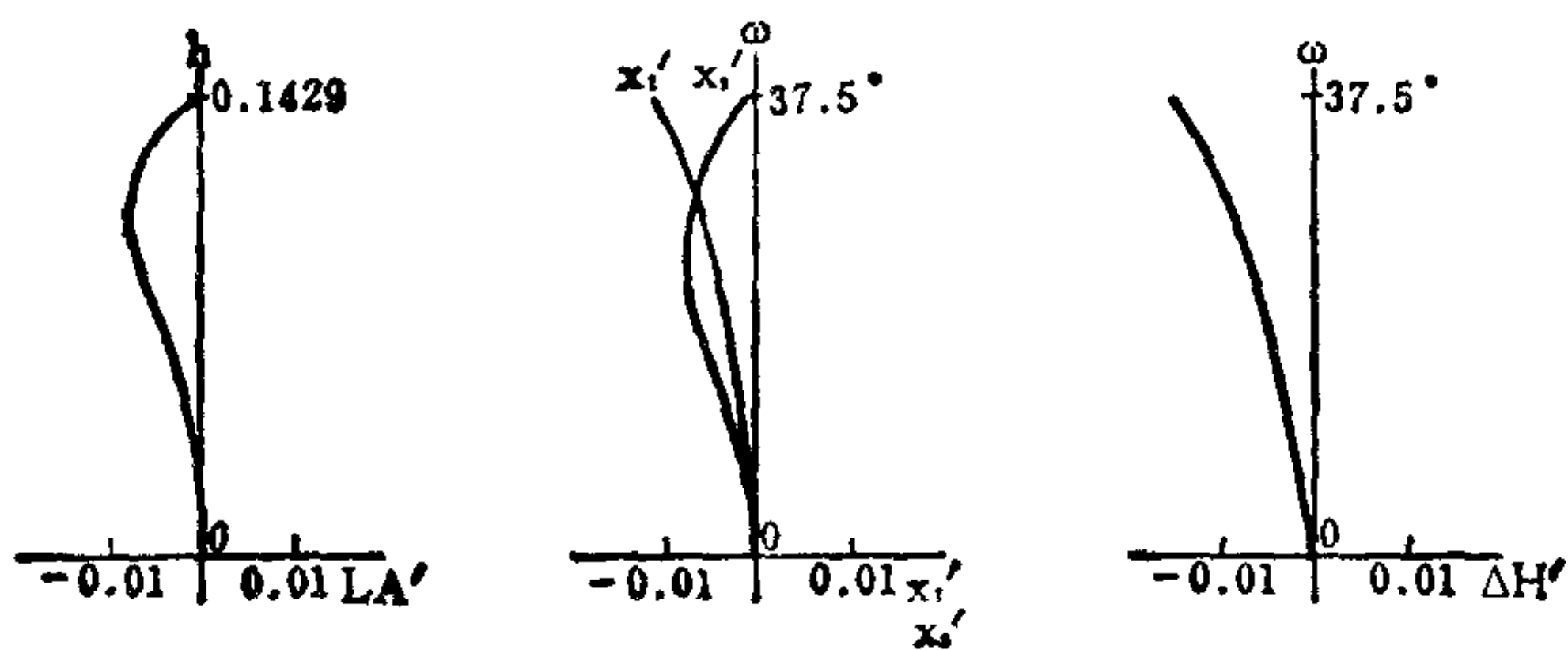

编号: 07-02-041

反远距型广角物镜

E.F.L=1

B.F.L=1.07463

FNo.=2

F.A.=±32°

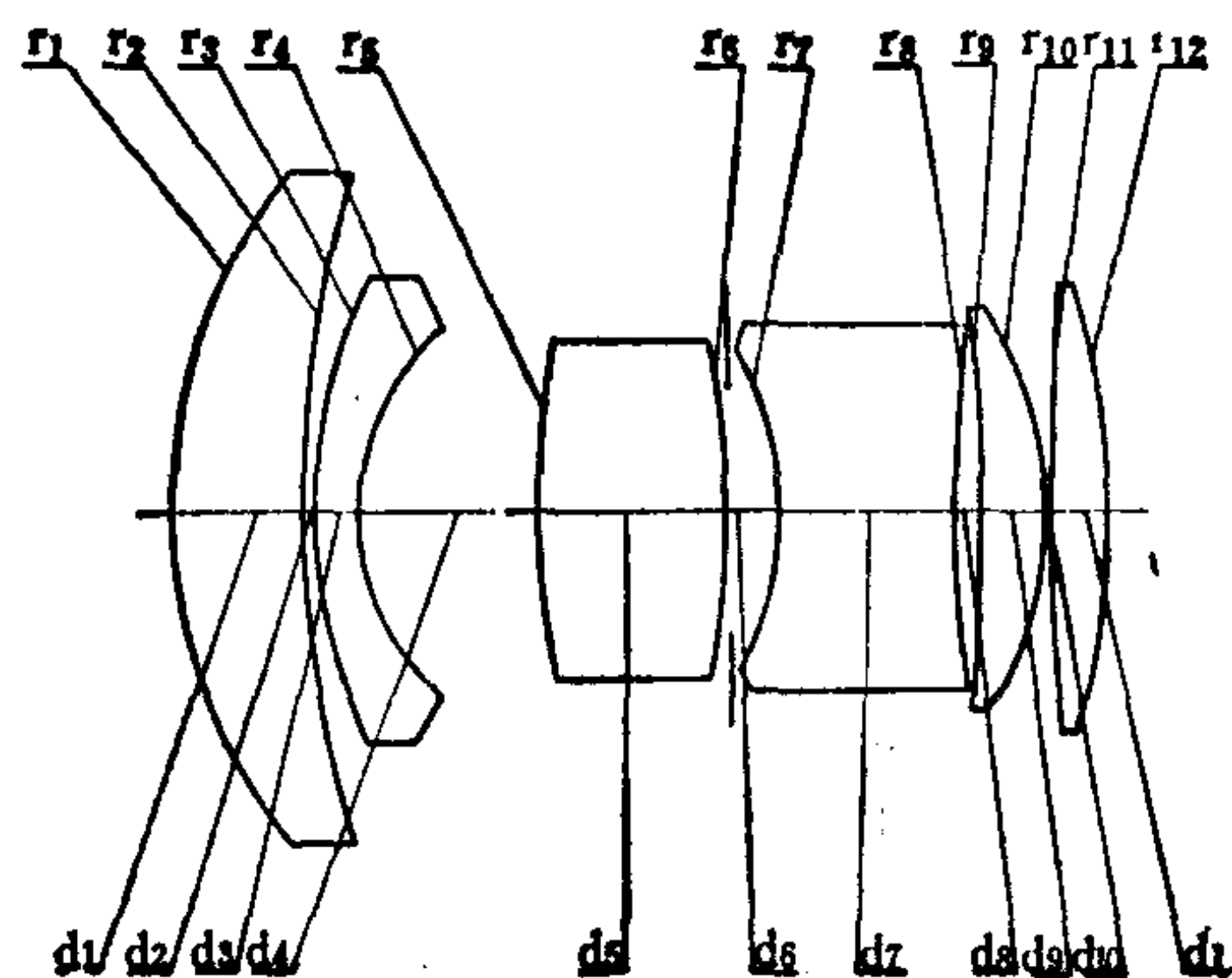

序号	r	d	n	v	序号	r	d	n	v
1	0.78816	0.20003	1.72000	50.3	7	-0.52950	0.27462	1.78472	25.7
2	2.12468	0.00400			8	4.55068	0.01938		
3	0.98386	0.05715	1.51835	60.3	9	-16.67865	0.09939	1.71300	53.9
4	0.36128	0.28096			10	-0.59009	0.00286		
5	2.69252	0.27296	1.80610	40.9	11	3.19140	0.08344	1.71300	53.9
6	-4.93715	0.08567*			12	-1.19632			

0.08567* = 0.01000 + 0.07567

	ΣS_1	ΣS_2	ΣS_3	ΣS_4	ΣS_5	HI	QP(1 ω)
	-0.002182	-0.000128	0.000891	-0.003932	-0.007776	0.62	-2.1%
h 或 ω %	LA'	$\Delta H'$	x'_t	x'_s	$x'_t - x'_s$	K'_{T1}	$K'_{T0.7}$
100	0.00192	-0.01309	-0.01065	-0.00272	-0.00793	0.022249	0.004188
70	-0.00575	-0.00607	-0.00577	-0.00984	0.00407	0.007458	0.000903

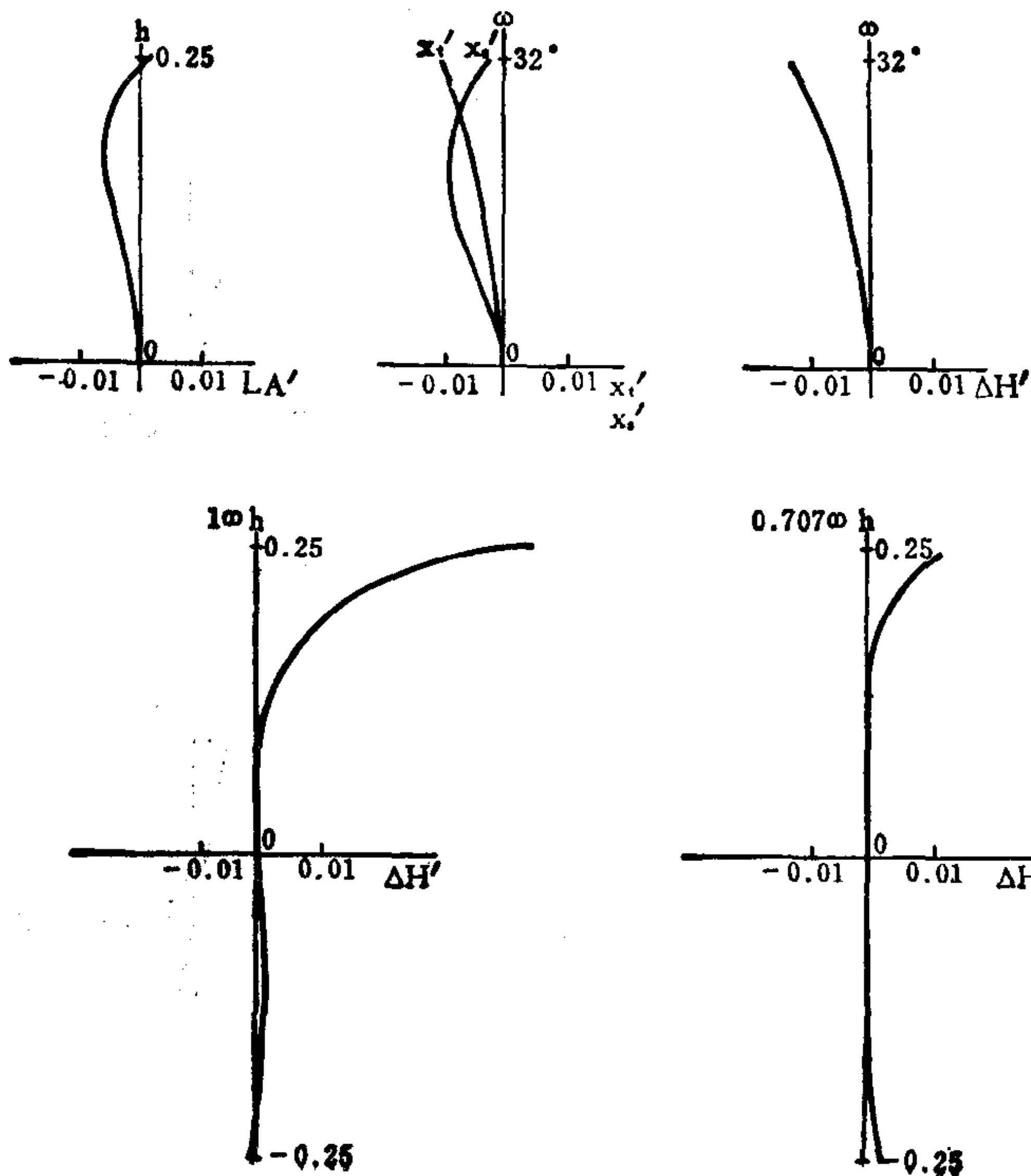

编号: 07-02-042

反远距型广角物镜

E.F.L=1

B.F.L=1.0872

FNo.=2.8

F.A.=±32°

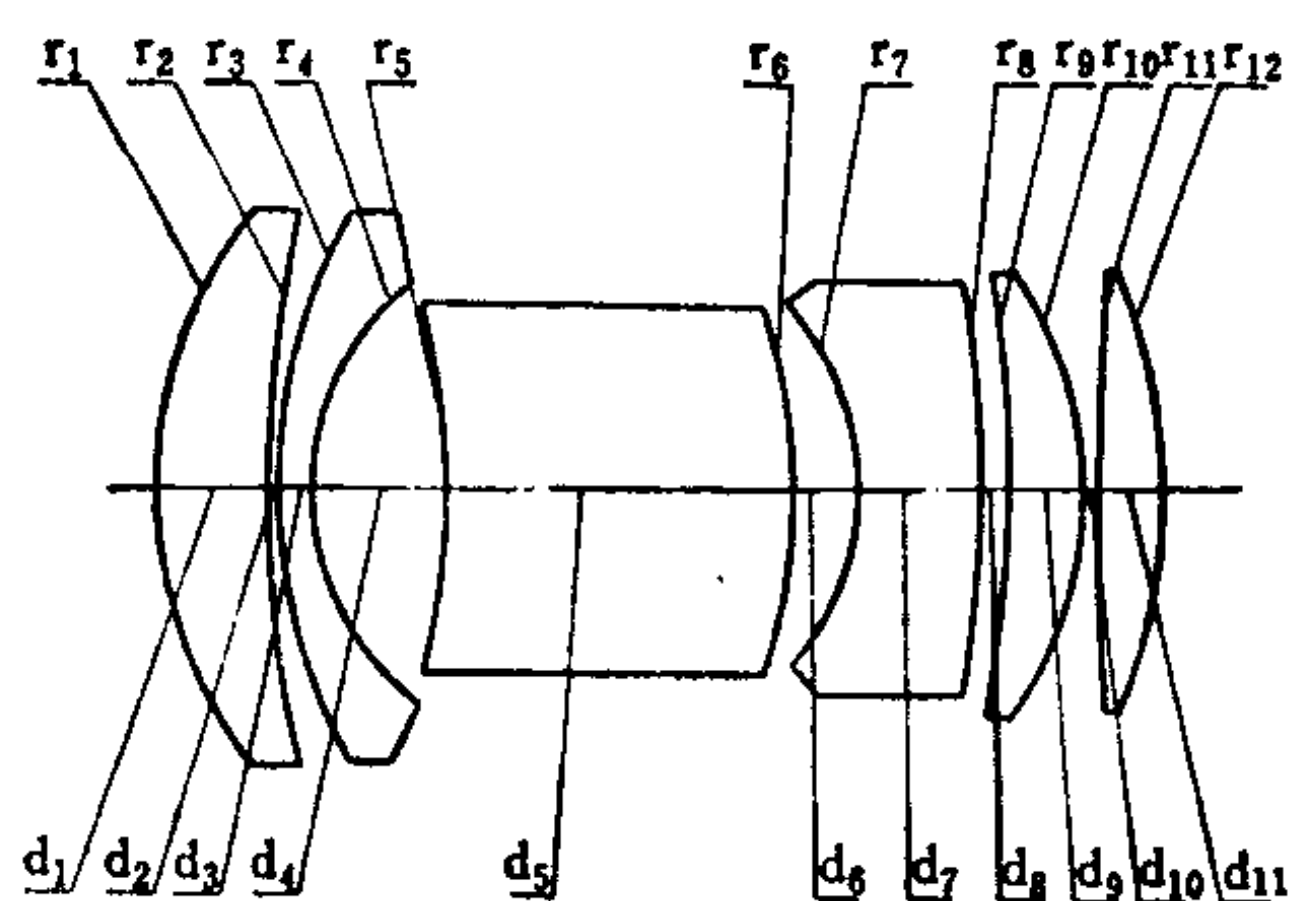

序号	r	d	n	v	序号	r	d	n	v
1	0.54727	0.11265	1.7432	49.4	7	-0.36042	0.13997	1.80518	25.4
2	1.42131	0.00282			8	-4.60381	0.02619		
3	0.62407	0.04224	1.51454	54.7	9	-1.18720	0.06928	1.63854	55.4
4	0.27143	0.14335			10	-0.40325	0.00282		
5	-7.48458	0.37287	1.80518	25.4	11	37.32366	0.06421	1.63854	55.4
6	-1.25726	0.05604*			12	-0.63641			

0.05604* = 0.02600 + 0.03004

	ΣS_1	ΣS_2	ΣS_3	ΣS_4	ΣS_5	HI	QP(1 ω)
	-0.000899	-0.000041	0.000552	-0.001677	-0.003592	0.62	-2%
h 或 ω %	LA'	$\Delta H'$	x'_t	x'_s	$x'_t - x'_s$	K'_{T1}	$K'_{T0.7}$
100	-0.00009	-0.01265	-0.00777	0.00250	-0.01027	-0.000130	-0.000033
70	-0.00452	-0.00428	-0.00198	-0.00596	0.00398	0.001755	0.000072

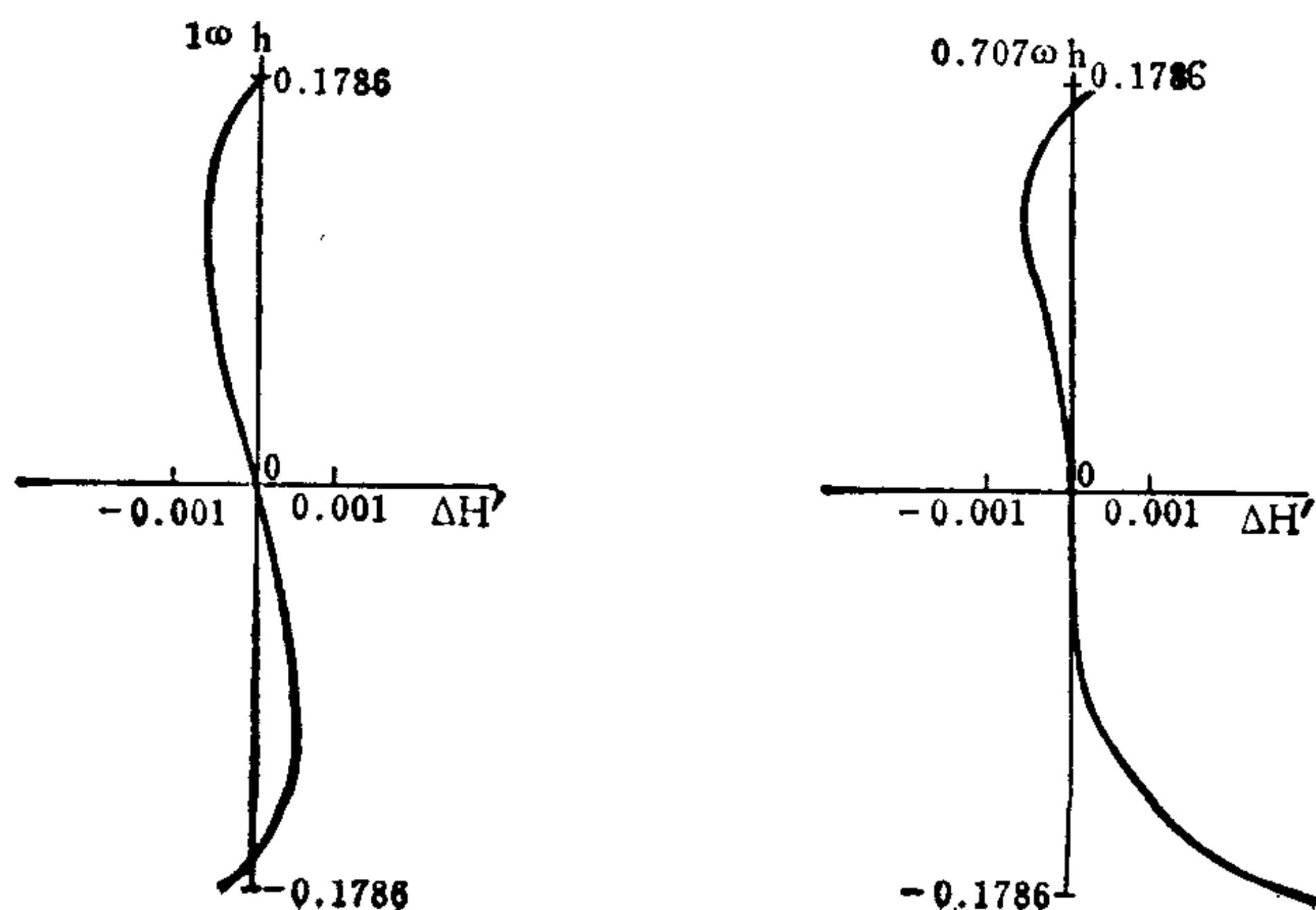
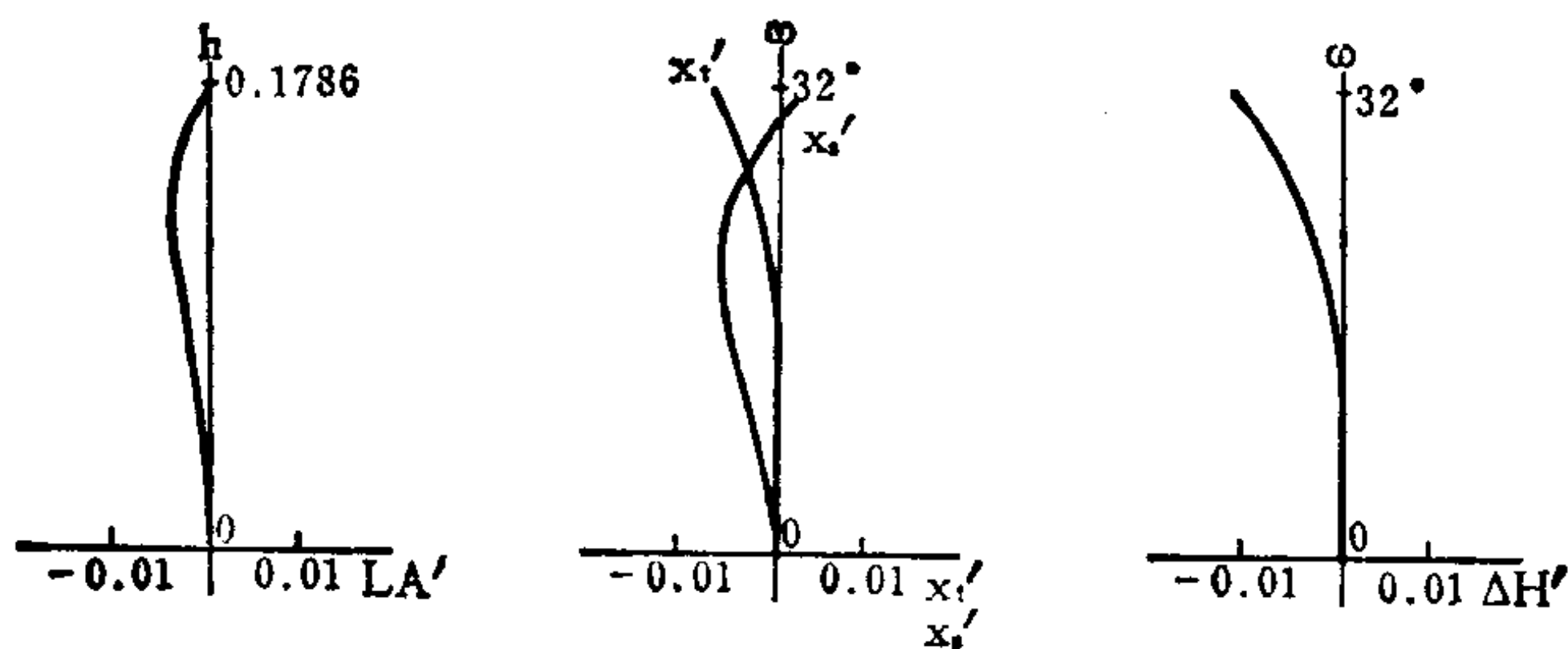

编号: 07-02-043

体积小重量轻的反远距型广角物镜

E.F.L = 100

B.F.L = 109.50

FNo. = 2.8

F.A. = ±31.5°

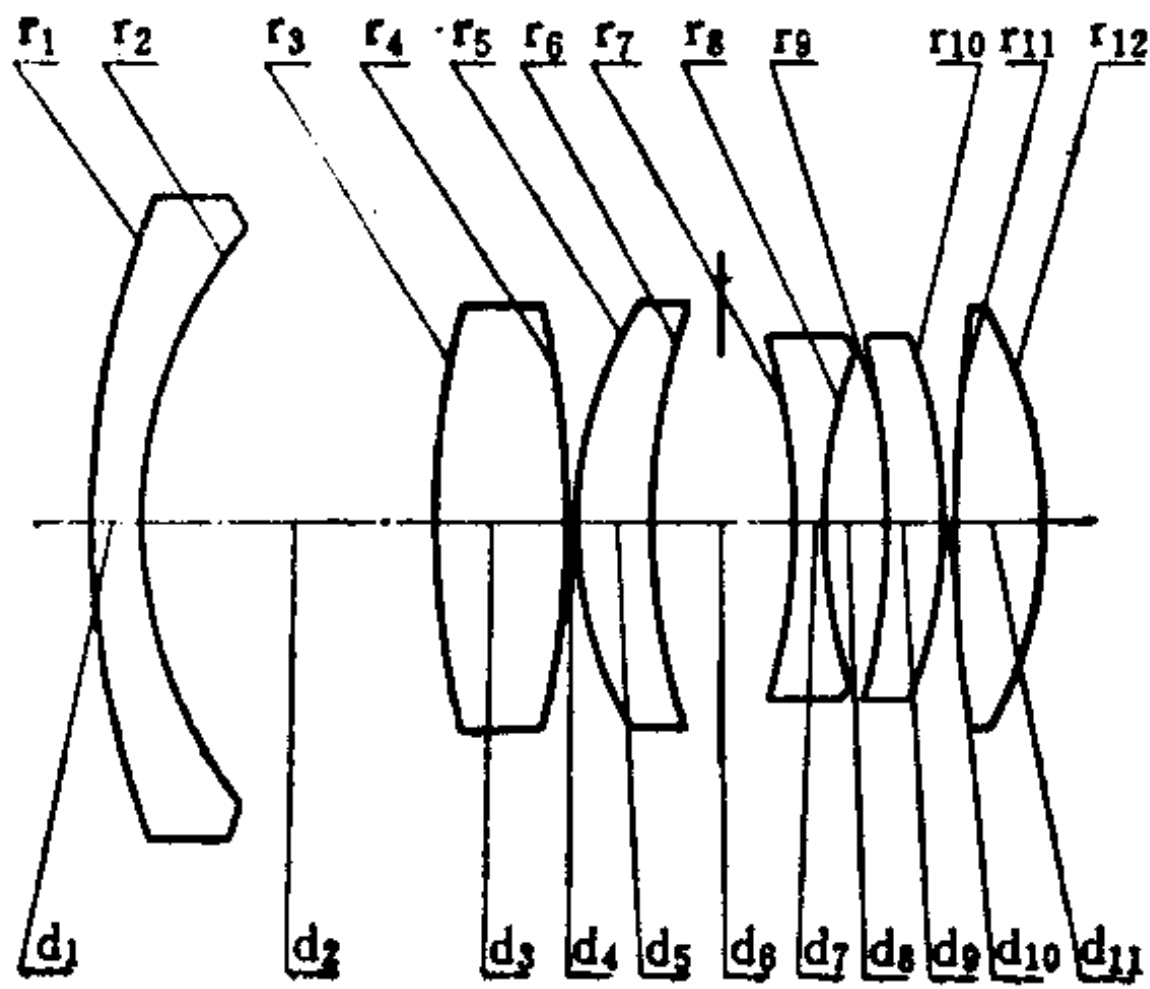

序号	r	d	n	v	序号	r	d	n	v
1	113.67	4.25	1.51633	64.0	7	-63.39	3.40	1.71736	29.5
2	47.25	32.55			8	84.24	5.09		
3	192.81	13.02	1.75700	47.8	9	-148.20	7.08	1.62041	60.2
4	-149.93	0.57			10	-66.76	0.28		
5	48.38	8.10	1.63930	44.8	11	1179.40	9.34	1.62041	60.2
6	63.54	15.00*			12	-50.45			

15.00* = 8.00 + 7.00

	ΣS_1	ΣS_2	ΣS_3	ΣS_4	ΣS_5	HI	QP(1 ω)
	-0.09739	-0.02754	0.01726	-0.20372	-0.29501	61.3	-0.3%
h 或 ω %	LA'	$\Delta H'$	x'_t	x'_s	$x'_t - x'_s$	K'_{t1}	$K'_{t0.7}$
100	0.0189	-0.2021	-1.834	1.394	-3.228	0.9451	0.2986
70	-0.5148	-0.2513	-0.898	-0.825	-0.073	0.5222	0.0683

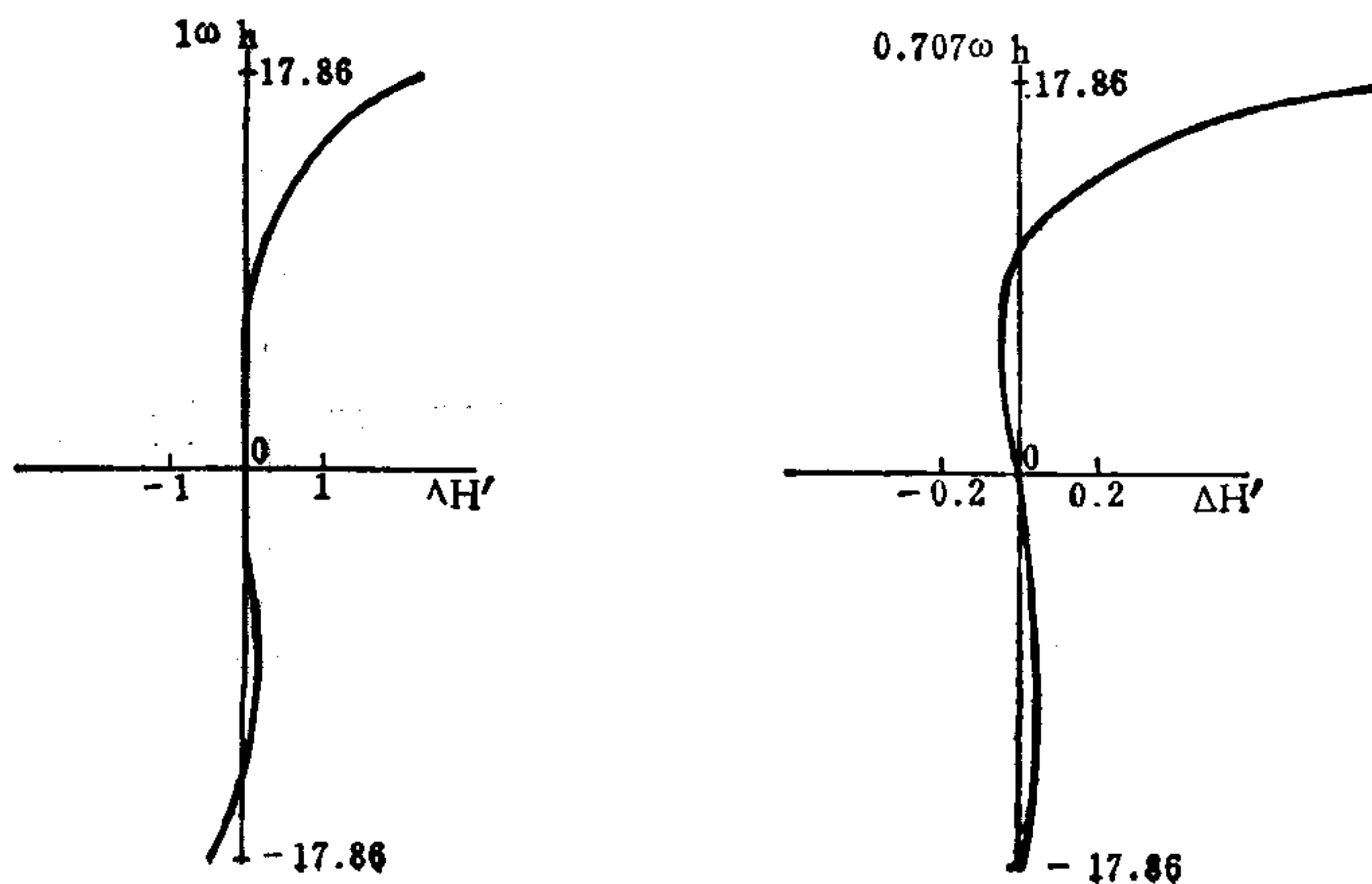
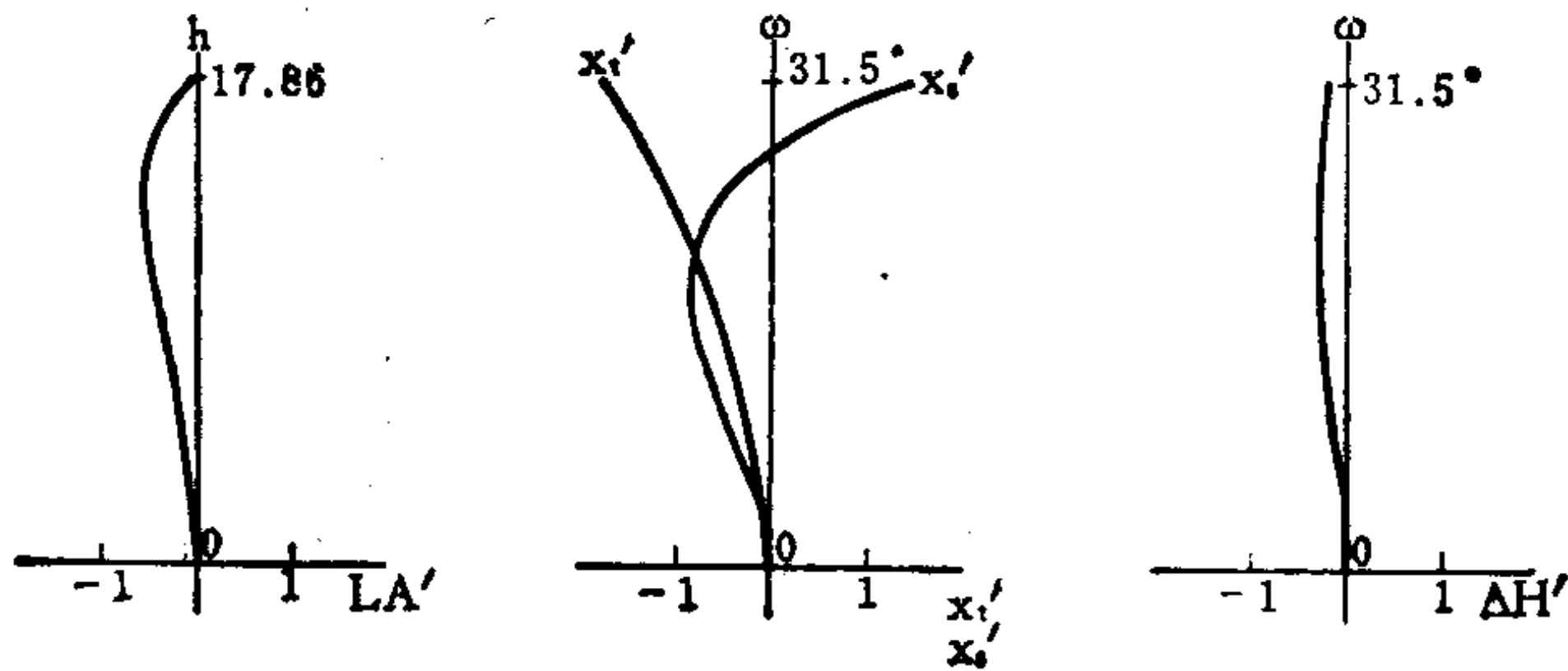

编号: 07-02-044

体积小重量轻的反远距型广角物镜

E.F.L = 100

B.F.L = 109.3

FNo. = 2.8

F.A. = ±31.5°

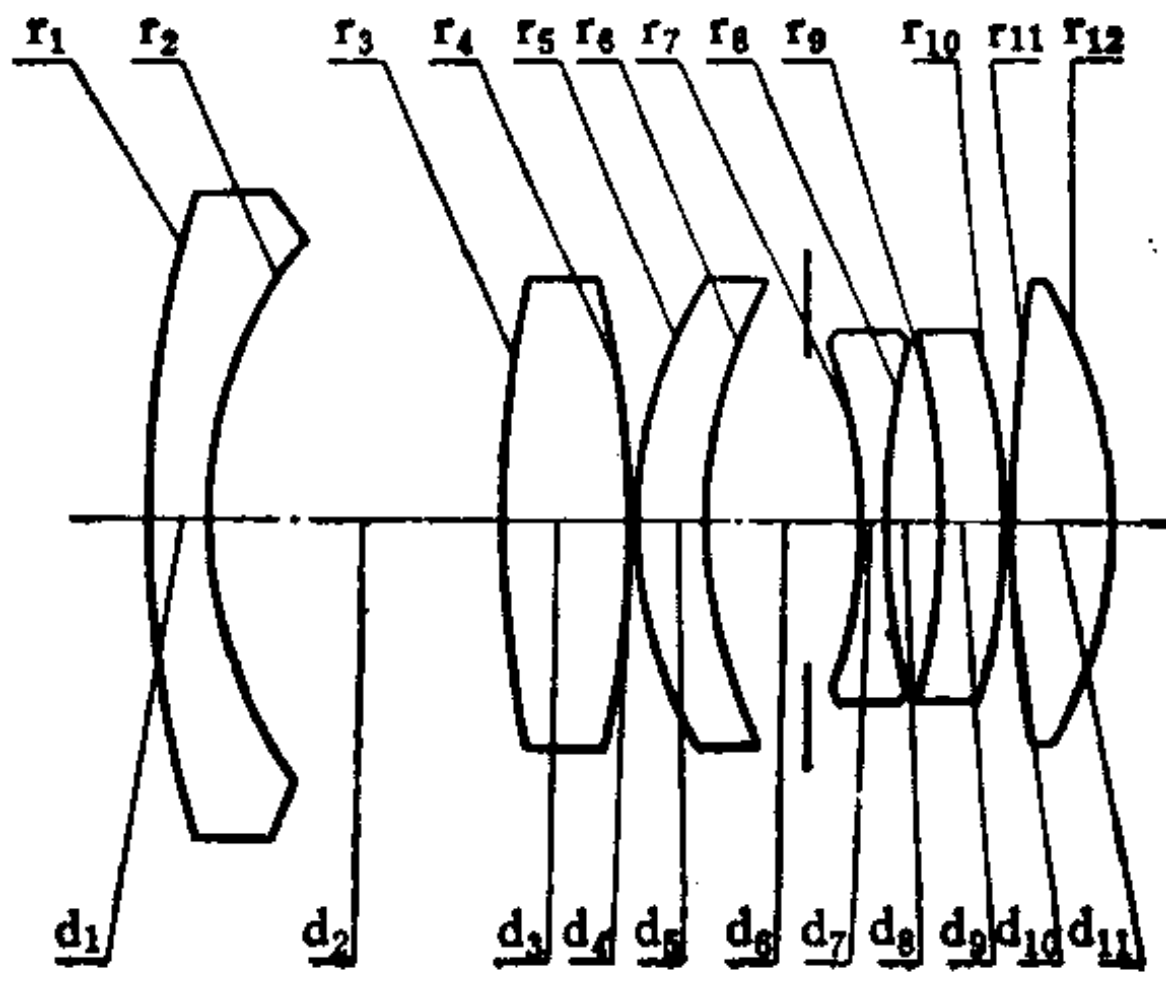

序号	r	d	n	v	序号	r	d	n	v
1	123.16	5.64	1.51633	64.0	7	-62.75	3.38	1.71736	29.5
2	47.88	31.02			8	86.78	5.08		
3	149.62	12.97	1.67003	47.3	9	-136.25	7.05	1.62041	60.2
4	-149.62	0.56			10	-64.25	0.28		
5	48.21	8.07	1.63930	44.8	11	575.60	9.31	1.62041	60.2
6	63.31	14.95*			12	-52.23			

14.95* = 8.00 + 6.95

	ΣS_1	ΣS_2	ΣS_3	ΣS_4	ΣS_5	HI	QP(1 ω)
	-0.09174	-0.04022	0.02068	-0.22831	-0.36935	61.3	-1%
h 或 ω %	LA'	$\Delta H'$	x'_i	x'_s	$x'_i - x'_s$	K'_{T1}	$K'_{T0.7}$
100	0.1304	-0.6591	-1.534	0.892	-2.426	0.5195	0.1387
70	-0.4557	-0.3632	-0.925	-1.015	0.090	0.2774	-0.0115

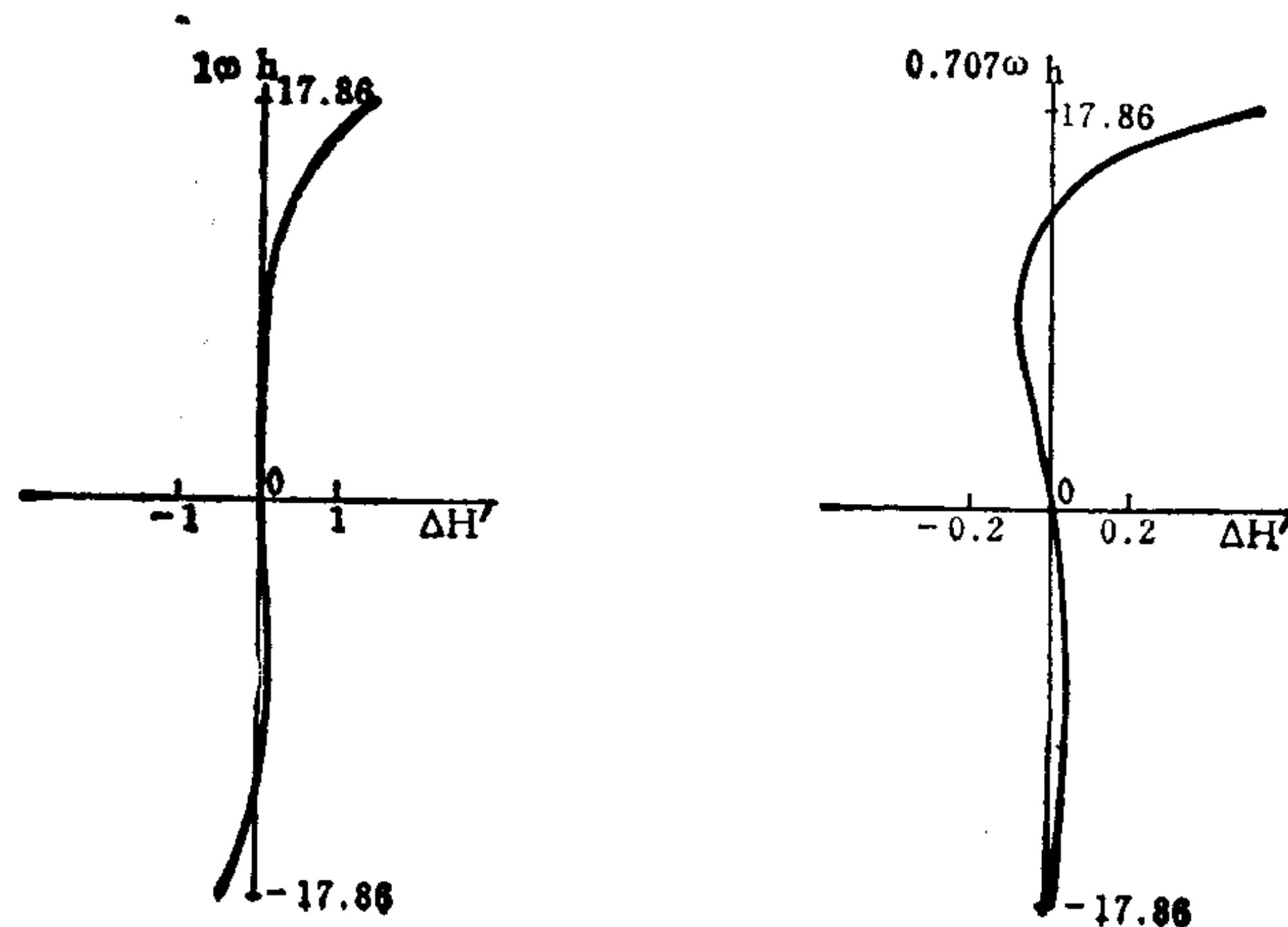
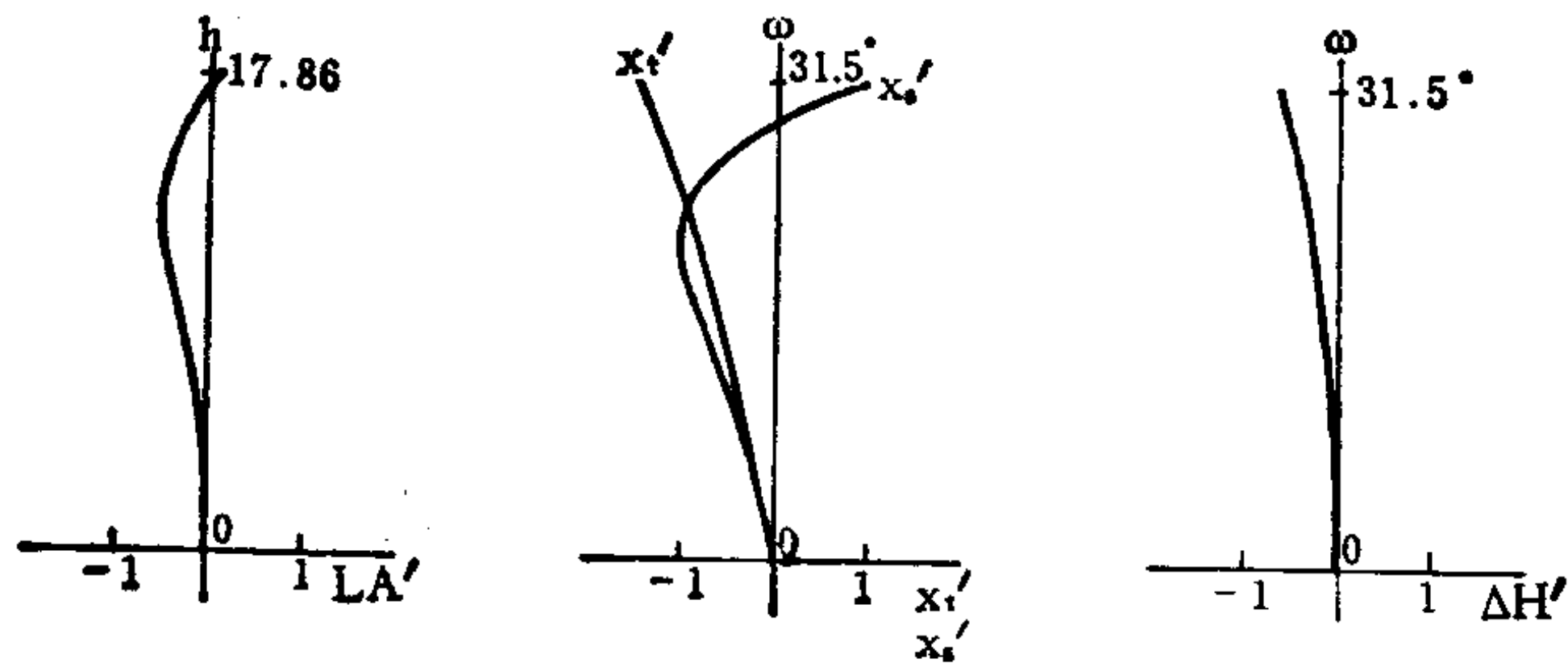

编号: 07-02-045

反远距型广角物镜

E.F.L=100

B.F.L=110.52

FNo.=2.8

F.A.=±33°

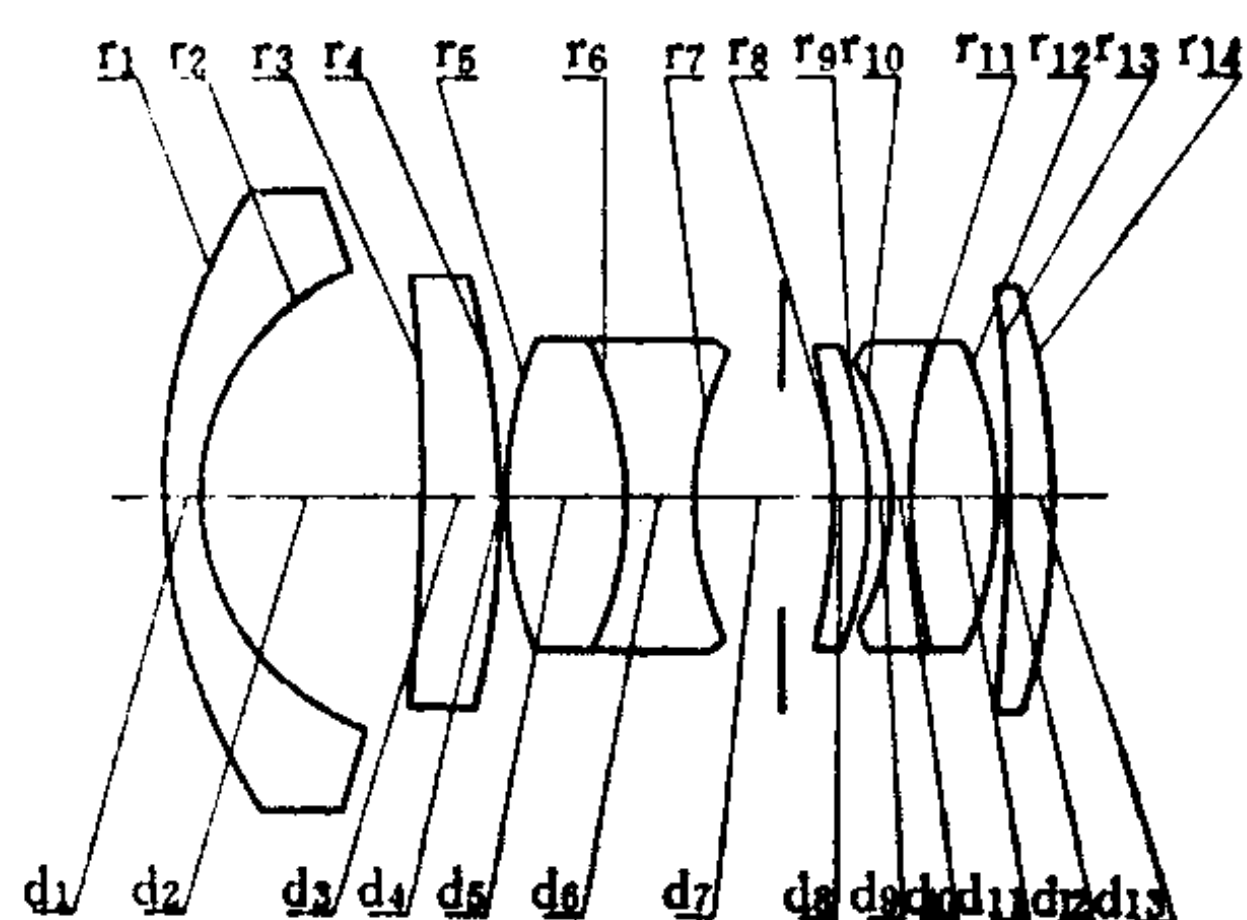

序号	r	d	n	v	序号	r	d	n	v
1	74.668	4.545	1.51633	64.1	8	-125.275	5.455	1.69350	53.2
2	32.895	29.060			9	-51.944	2.182		
3	-3515.000	9.822	1.58144	40.7	10	-34.223	2.727	1.72342	38.0
4	-189.645	0.364			11	176.154	10.000	1.51633	64.1
5	64.922	14.653	1.77250	49.6	12	-41.447	0.364		
6	-46.939	9.128	1.56732	42.8	13	-230.971	6.364	1.69350	53.2
7	52.318	16.915*			14	-74.175			

16.915* = 9.000 + 7.915

	ΣS_1	ΣS_2	ΣS_3	ΣS_4	ΣS_5	HI	QP(1 ω)
	-0.07109	0.00175	0.02046	-0.12054	-0.43756	64.9	-1.6%
h 或 ω %	LA'	$\Delta H'$	x'_i	x'_s	$x'_i - x'_s$	K'_{T1}	$K'_{T0.7}$
100	-0.412	-1.089	-0.974	0.084	-1.058	-47.7986	0.2405
70	-0.153	-0.479	-0.372	-0.517	0.145	2.9197	0.0195

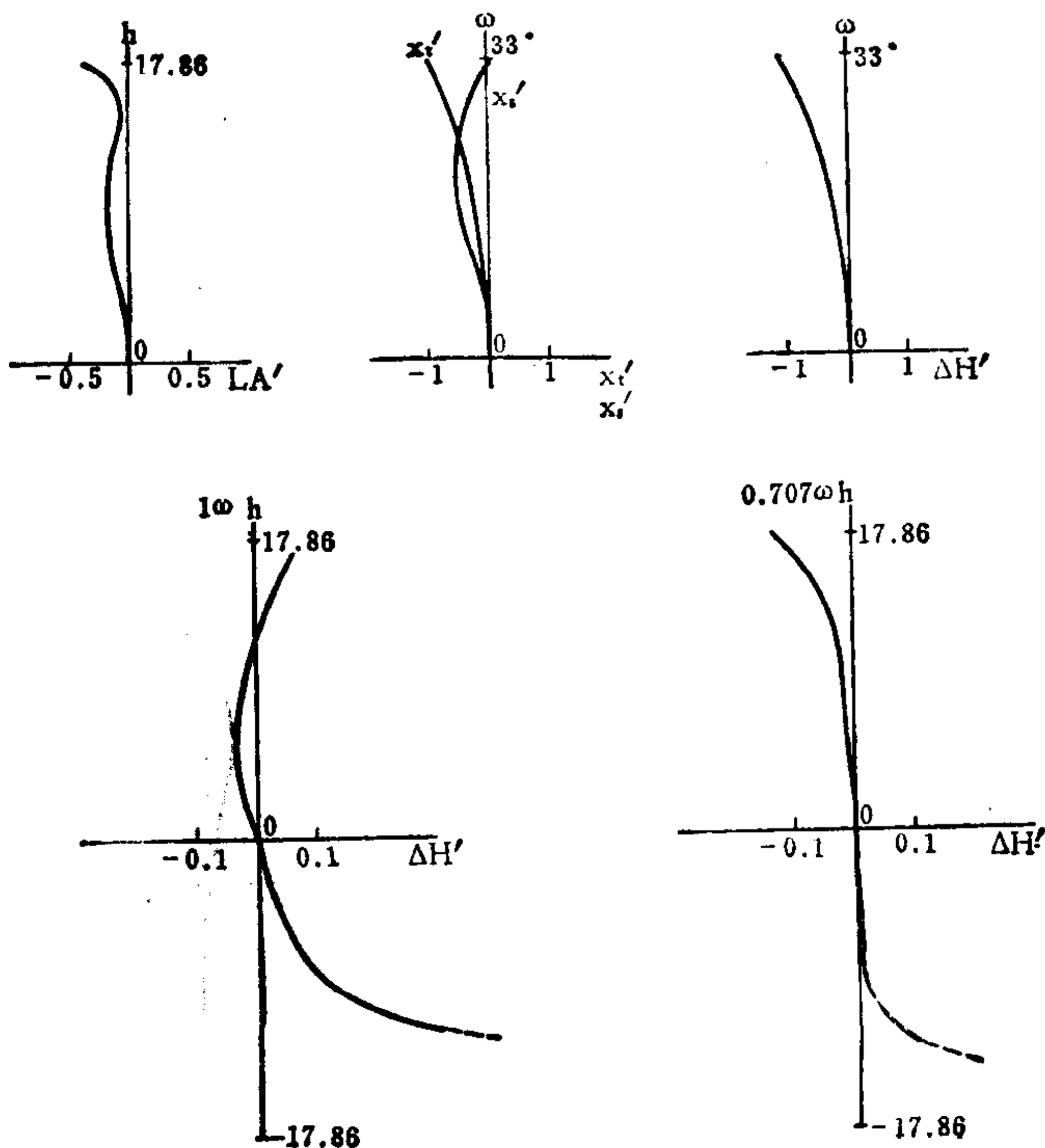

编号: 07-02-046

反远距型广角物镜

E.F.L = 100

B.F.L = 129.36

FNo. = 2.8

F.A. = ± 37.5°

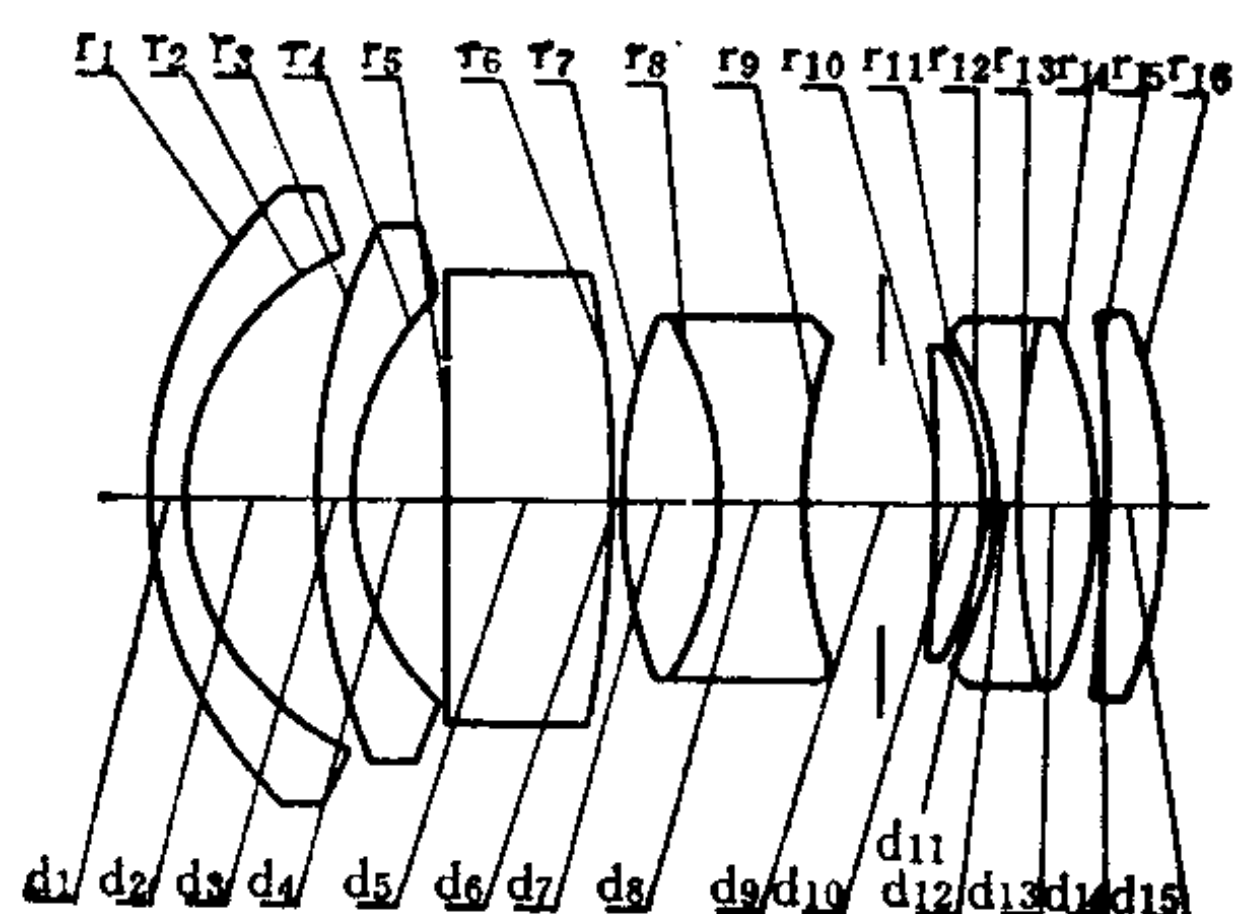

序号	r	d	n	v	序号	r	d	n	v
1	69.506	5.388	1.48749	70.1	9	92.675	20.475*		
2	42.797	20.496			10	-204.748	6.466	1.71300	53.9
3	118.969	5.388	1.48749	70.1	11	-70.563	1.789		
4	45.476	14.289			12	-49.247	3.233	1.83400	37.2
5	∞	27.113	1.56732	42.8	13	125.004	12.069	1.48749	70.1
6	-172.419	0.431			14	-54.415	0.431		
7	86.619	15.302	1.77250	49.6	15	-377.167	8.621	1.77250	49.6
8	-53.191	12.888	1.56732	42.8	16	-78.343			

20.475* = 10.000 + 10.475

	ΣS_1	ΣS_2	ΣS_3	ΣS_4	ΣS_5	HI	QP(1 ω)
	-0.06143	-0.03329	0.04593	-0.14955	-0.71092	76.7	-2.2%
h 或 ω %	LA'	$\Delta H'$	x'_t	x'_s	$x'_t - x'_s$	K'_{T1}	$K'_{r0.7}$
100	-0.212	-1.673	-1.418	0.135	-1.553	2.4935	0.4120
70	-0.191	-0.811	-0.087	-0.631	0.544	0.6943	0.0185

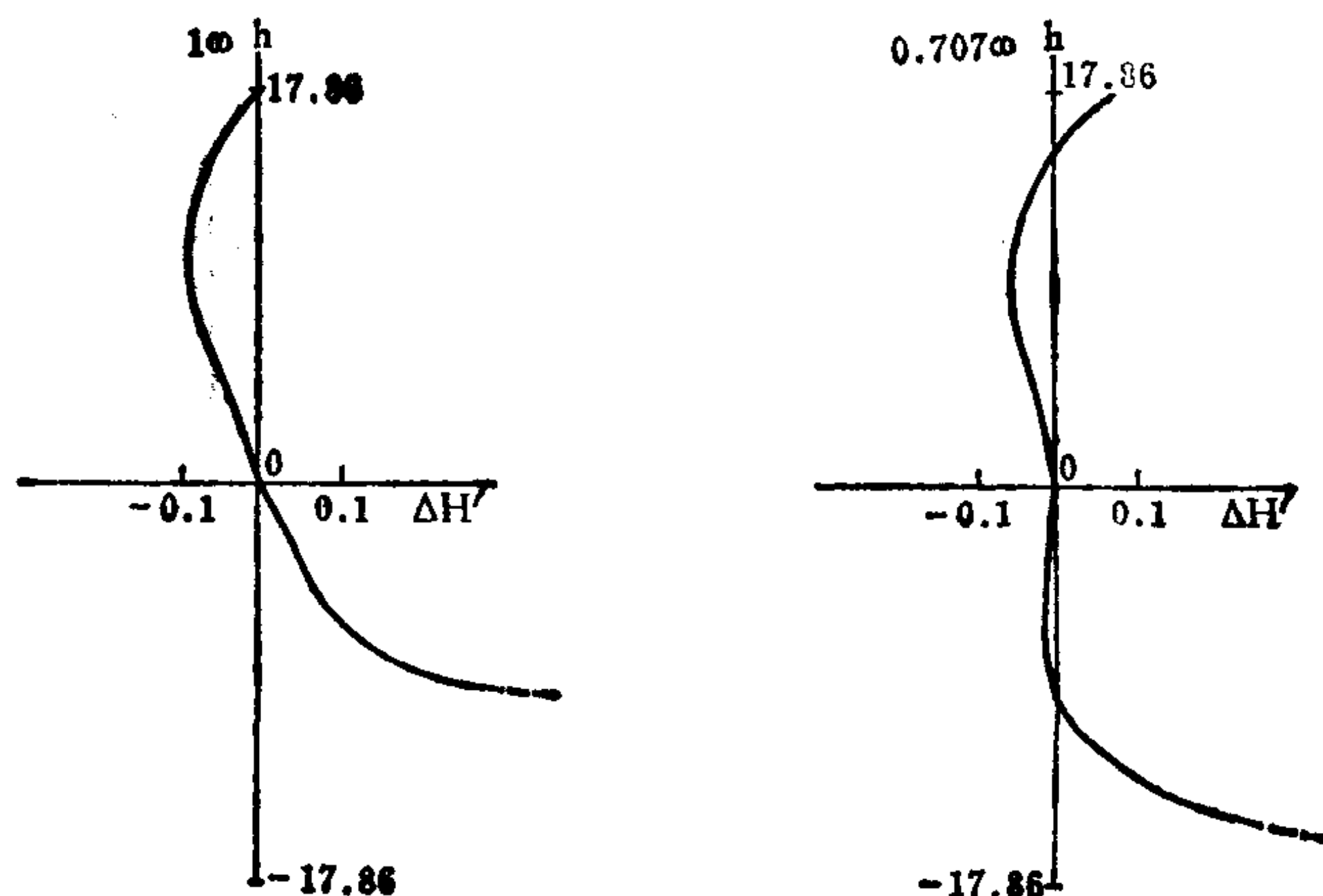
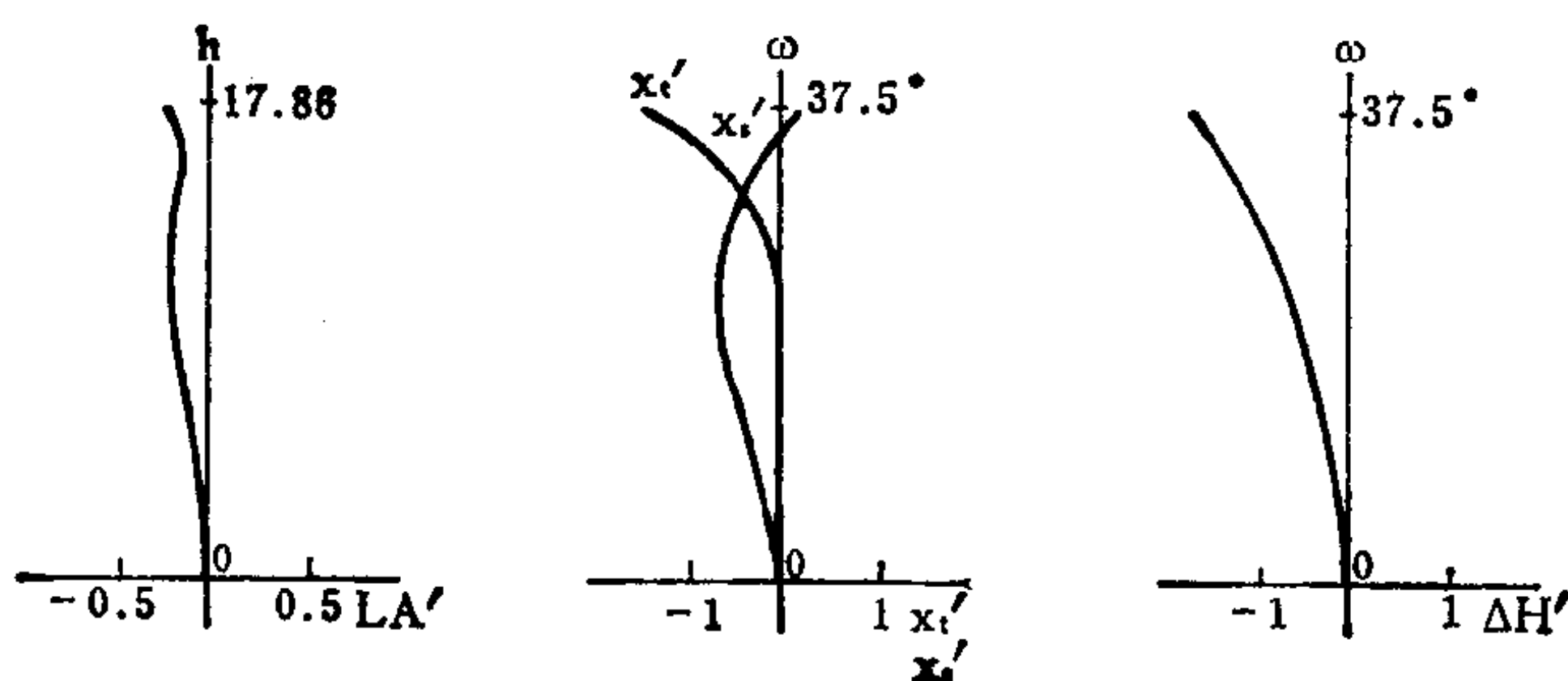

编号: 07-02-047

反远距型广角物镜

E.F.L = 100

B.F.L = 109.18

FNo. = 2.8

F.A. = ± 33°

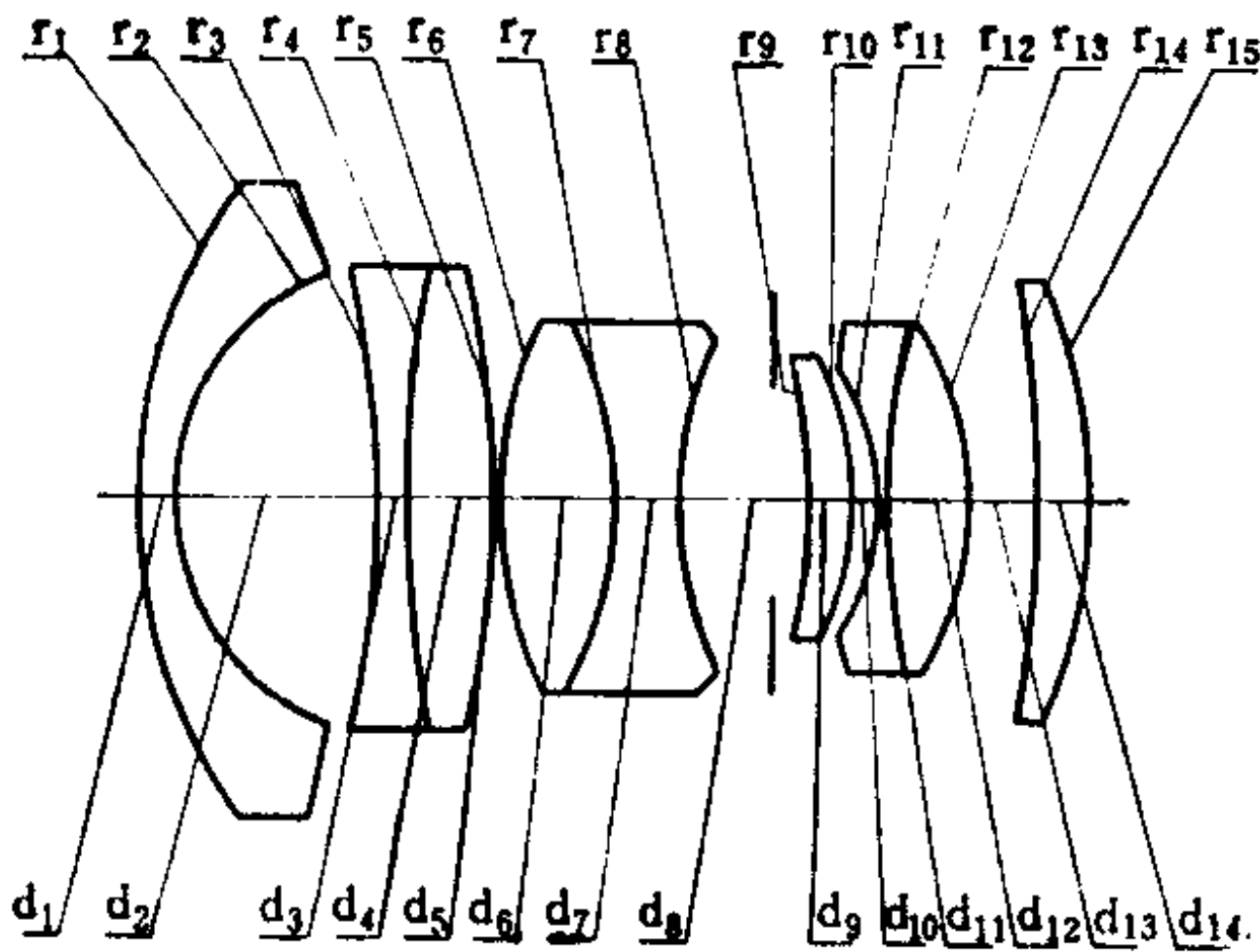

序号	r	d	n	v	序号	r	d	n	v
1	68.405	4.545	1.51633	64.1	9	-121.940	5.455	1.69350	53.2
2	32.462	25.486			10	-49.936	2.182		
3	-2050.000	5.455	1.51742	52.3	11	-33.182	2.723	1.72342	38.0
4	181.818	10.266	1.54814	45.8	12	276.178	10.000	1.51633	64.1
5	-187.273	0.364			13	-41.347	0.364		
6	61.843	14.653	1.77250	49.6	14	-227.273	6.364	1.69350	53.2
7	-46.913	7.874	1.56732	42.8	15	-73.983			
8	47.916	16.934*							

16.934* = 9.000 + 7.934

	ΣS_1	ΣS_2	ΣS_3	ΣS_4	ΣS_5	HI	QP(1 ω)
	-0.05161	0.01684	0.02244	-0.11601	-0.47267	64.9	-2%
h 或 ω %	LA'	$\Delta H'$	x'_i	x'_s	$x'_i - x'_s$	K'_{T1}	$K'_{T0.7}$
100	-0.2019	-1.301	-0.855	0.121	-0.976	-47.5141	0.2500
70	0.0058	-0.532	-0.287	-0.464	0.177	3.5660	0.0677

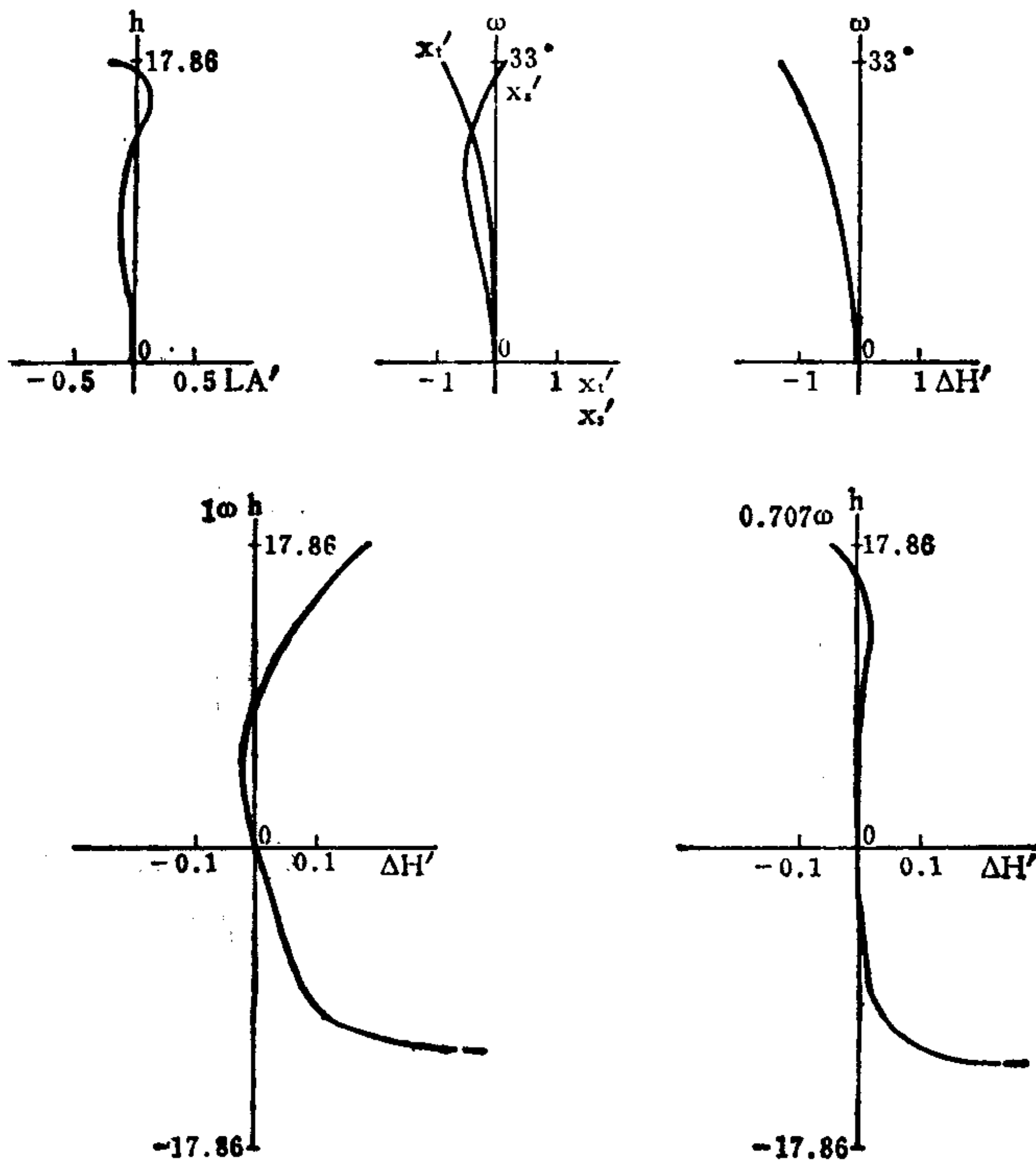

编号: 07-02-048

反远距型超广角物镜

E.F.L=1

B.F.L=1.737

FNo.=2.8

F.A.=±46°

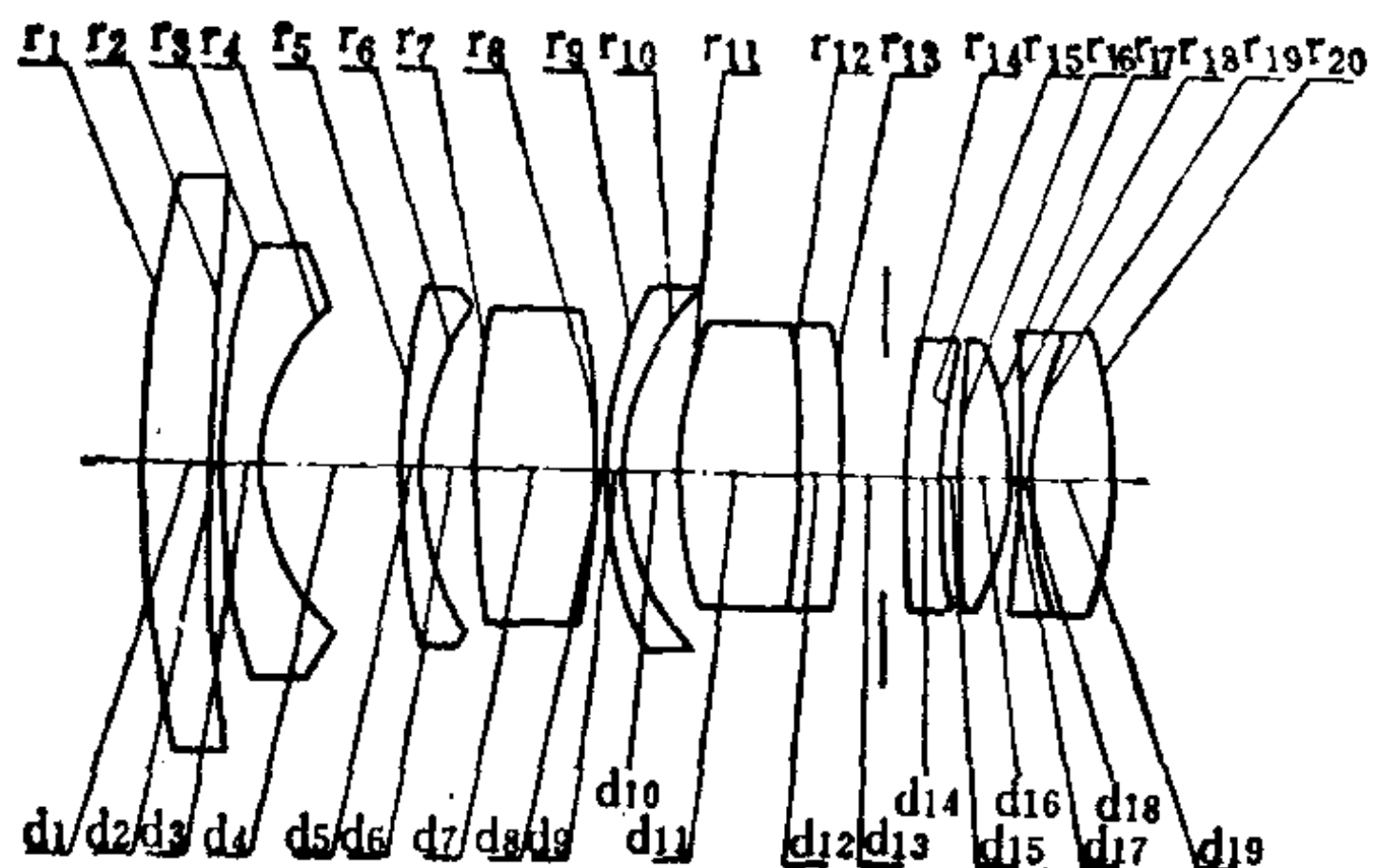

序号	r	d	n	v	序号	r	d	n	v
1	2.9788	0.1850	1.69680	55.8	11	0.8793	0.3134	1.70030	47.7
2	9.1510	0.0039			12	-3.0738	0.1143	1.57250	57.5
3	1.6448	0.0818	1.61800	63.0	13	-2.2163	0.1552*		
4	0.5521	0.2531			14	30.7729	0.0678	1.80518	25.2
5	1.8573	0.0600	1.61800	63.0	15	1.2956	0.0569		
6	0.6791	0.1400			16	32.9072	0.1171	1.61800	63.0
7	18.8399	0.3053	1.75570	27.5	17	-0.9373	0.0039		
8	-4.6715	0.0050			18	-6.8533	0.0500	1.7650	46.3
9	1.0595	0.0633	1.78500	49.9	19	1.0961	0.2027	1.60311	60.9
10	0.6401	0.1039			20	-1.0057			

0.1552* = 0.0776 + 0.0776

	ΣS_1	ΣS_2	ΣS_3	ΣS_4	ΣS_5	HI	QP(1 ω)
	-0.00208	0.00179	-0.00168	-0.00191	-0.01106	1	0.02%
h 或 ω %	LA'	$\Delta H'$	x'_t	x'_s	$x'_t - x'_s$	K'_{t1}	$K'_{t0.7}$
100	0.00457	0.00025	0.0117	0.0073	0.0044	-0.00366	-0.00188
70	-0.00799	-0.01642	-0.0143	-0.0166	0.0023	-0.00161	-0.00060

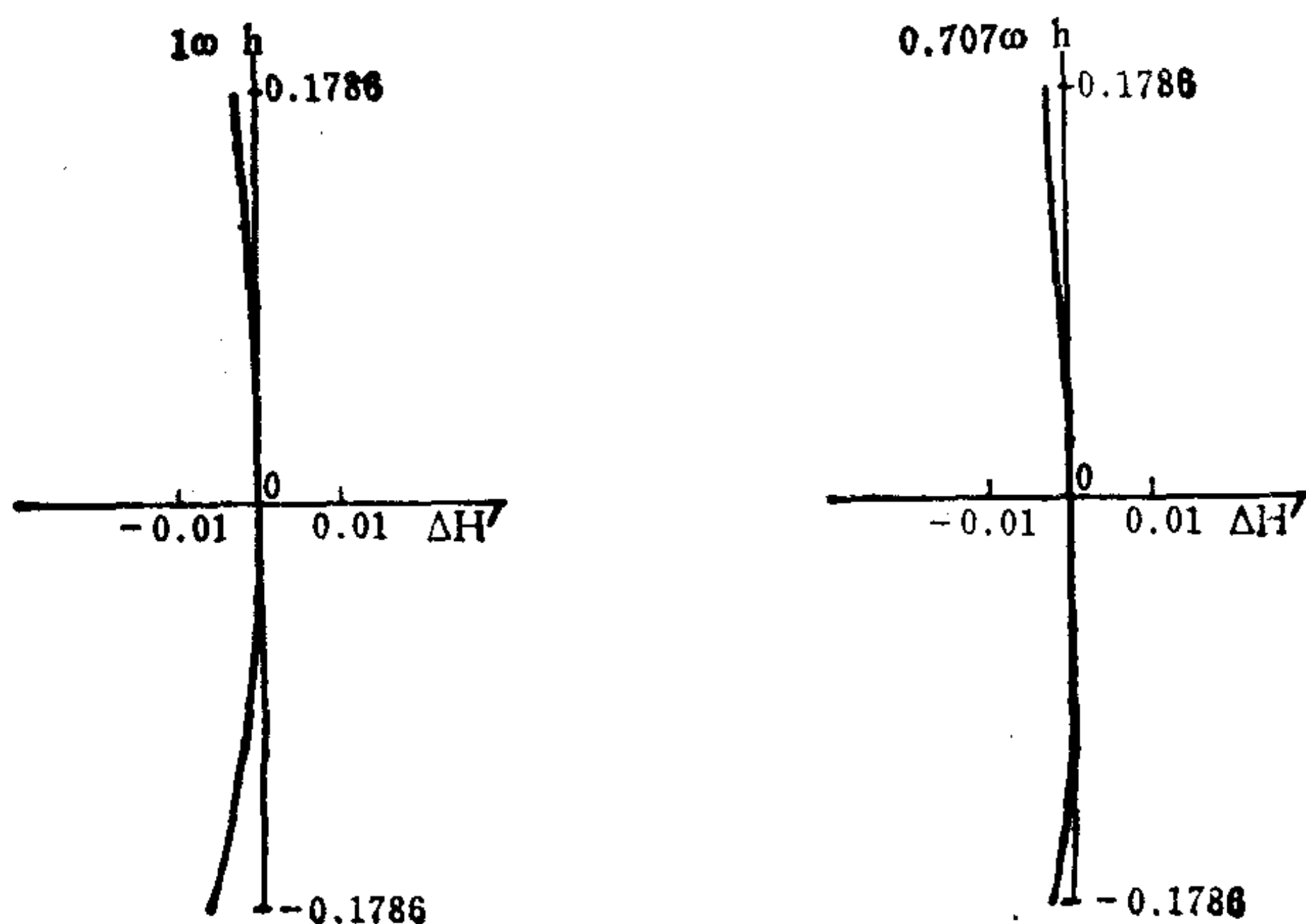
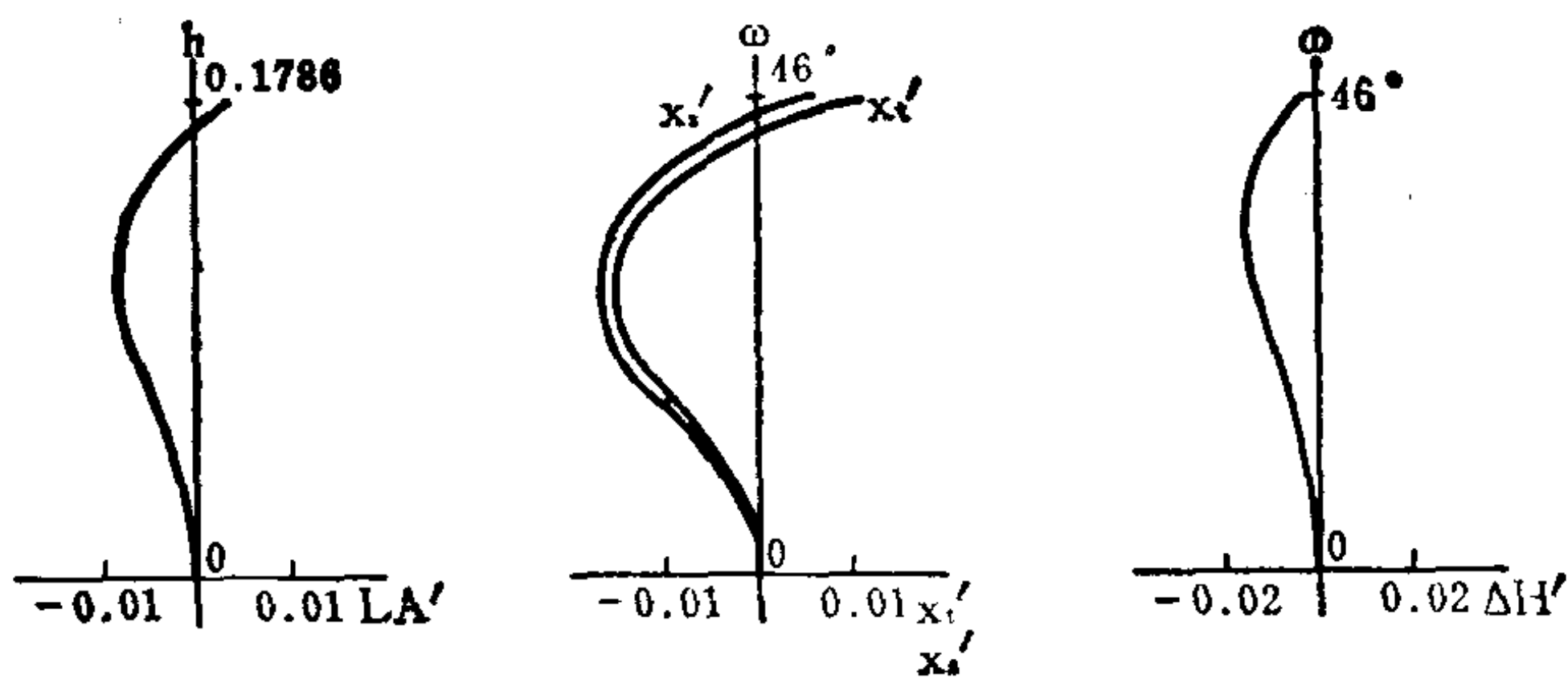

编号: 07-02-049

反远距离型超广角物镜

E.F.L=1

B.F.L=1.75

FNo.=2.8

F.A.=±46°

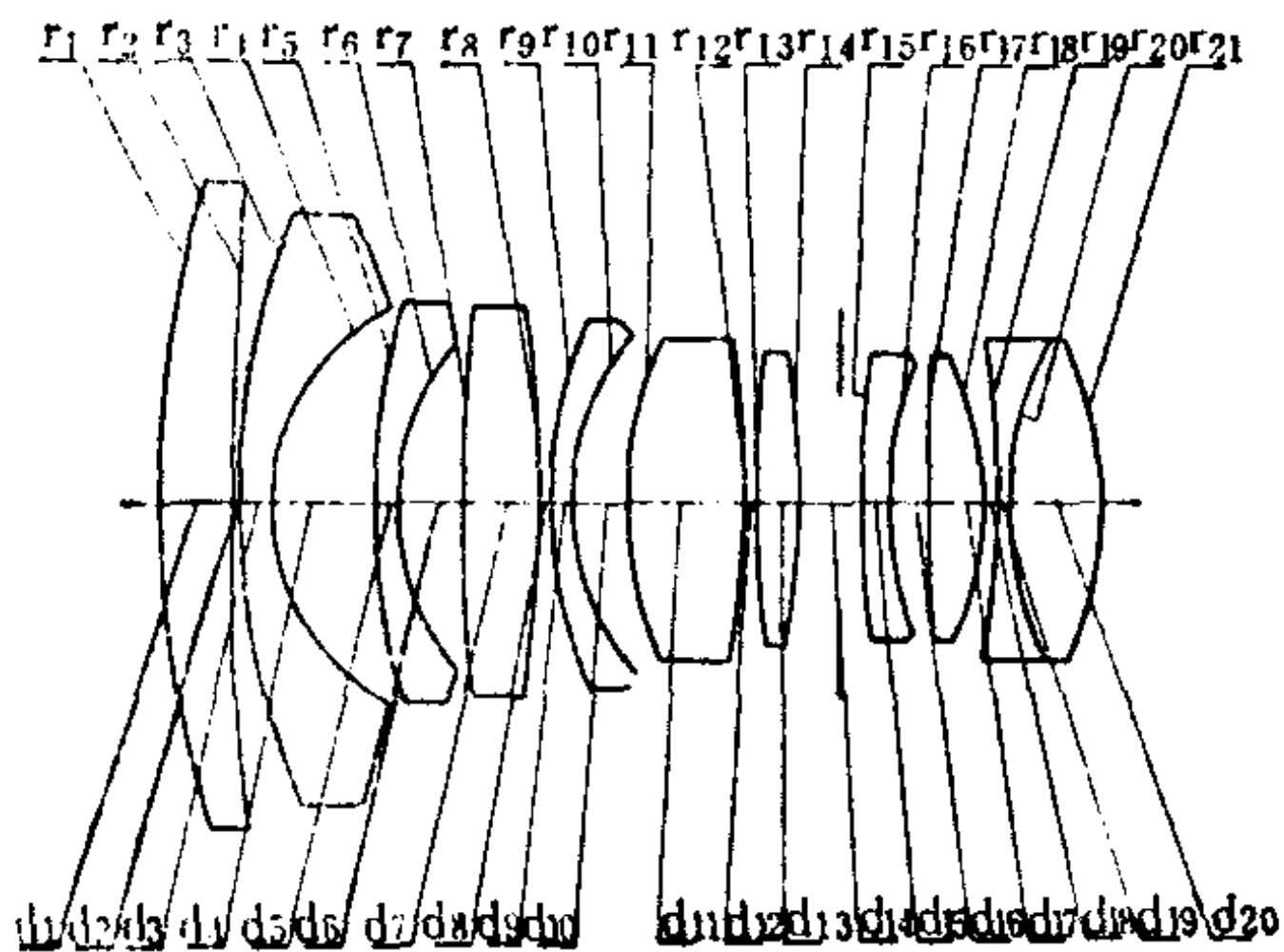

序号	r	d	n	v	序号	r	d	n	v
1	2.9788	0.1850	1.69680	55.8	12	-12.0444	0.0200		
2	9.6129	0.0039			13	4.9086	0.1064	1.57250	57.5
3	1.7958	0.0818	1.61800	63.0	14	-2.5370	0.1535*		
4	0.5577	0.2531			15	7.7947	0.0679	1.80518	25.2
5	1.7907	0.0600	1.61762	52.7	16	1.2044	0.0807		
6	0.6315	0.1404			17	35.2347	0.1194	1.61800	63.0
7	19.2253	0.2017	1.76182	26.3	18	-0.8918	0.0039		
8	-5.3552	0.0050			19	-7.1170	0.0500	1.79950	42.5
9	1.1379	0.0633	1.77450	50.6	20	1.0228	0.2000	1.60311	60.9
10	0.6569	0.1039			21	-1.0394			
11	0.9120	0.2986	1.70154	41.1					

0.1535* = 0.0776 + 0.0759

	ΣS_1	ΣS_2	ΣS_3	ΣS_4	ΣS_5	HI	QP(1 ω)
	-0.00199	0.00122	-0.00083	-0.00193	-0.01409	1	-1.6%
h 或 ω %	LA'	$\Delta H'$	x'_t	x'_s	$x'_t - x'_s$	K'_{T1}	$K'_{T0.7}$
100	-0.00094	-0.01686	0.01138	0.00800	0.00338	-0.00327	-0.00177
70	-0.00786	-0.01969	-0.01140	-0.01567	0.00427	-0.00109	-0.00056

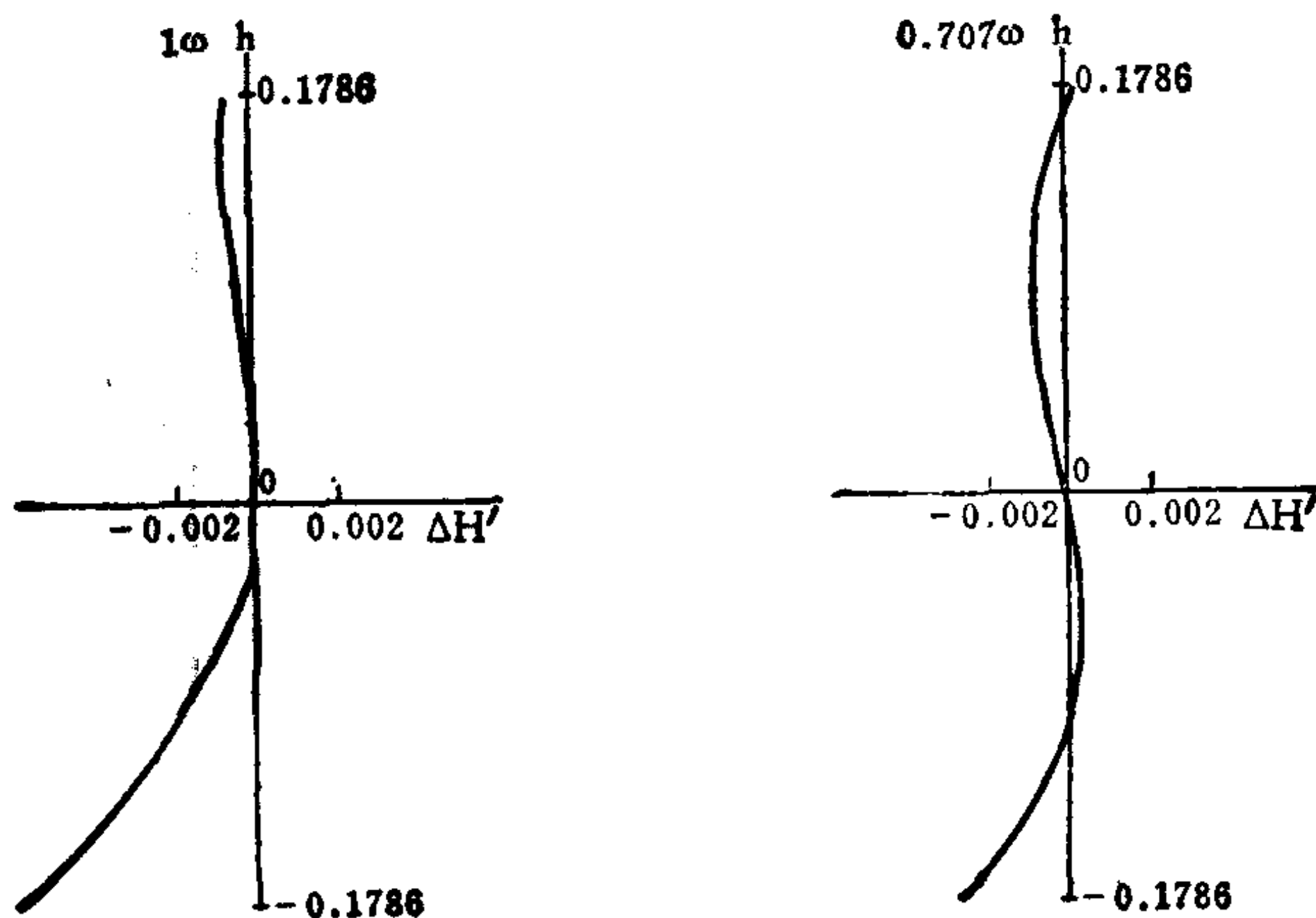
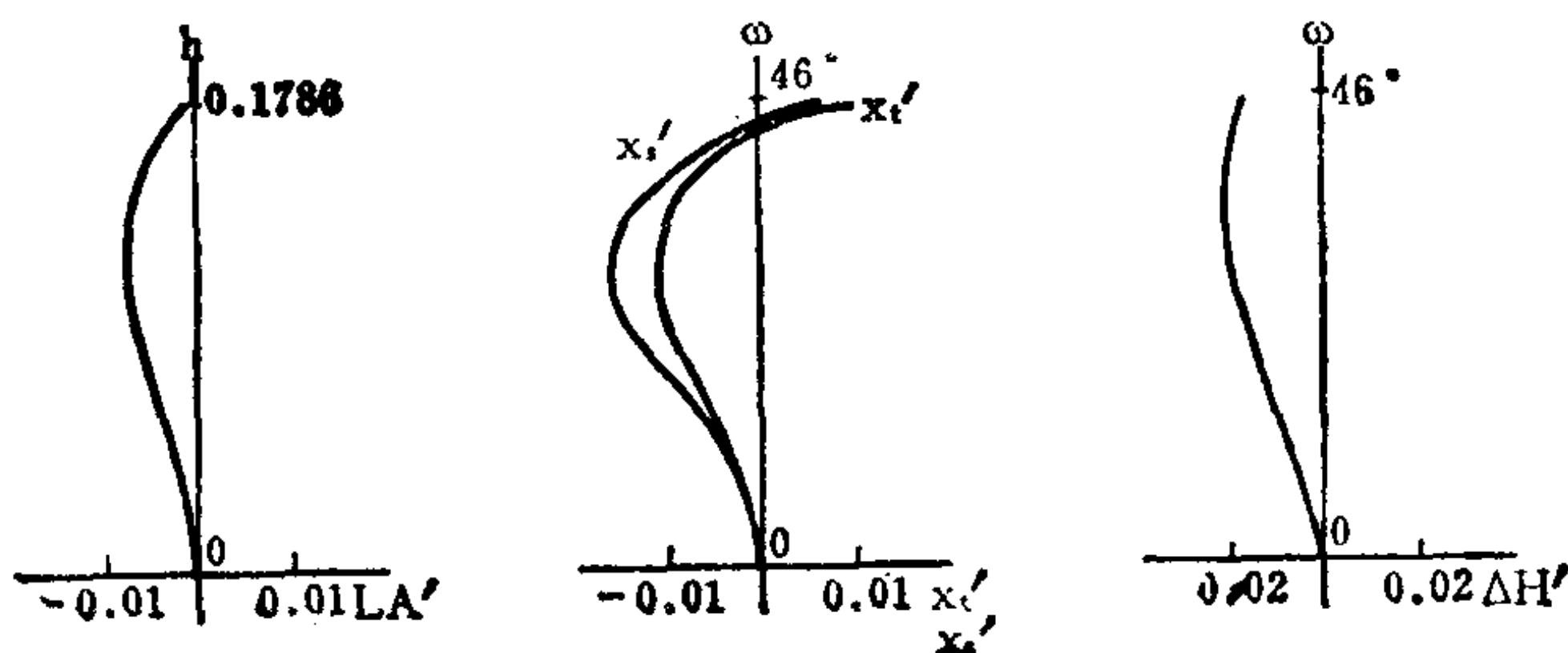

编号: 07-02-050

反远距型超广角物镜

E.F.L=1

B.F.L=1.746

FNo.=2.8

F.A.=±46°

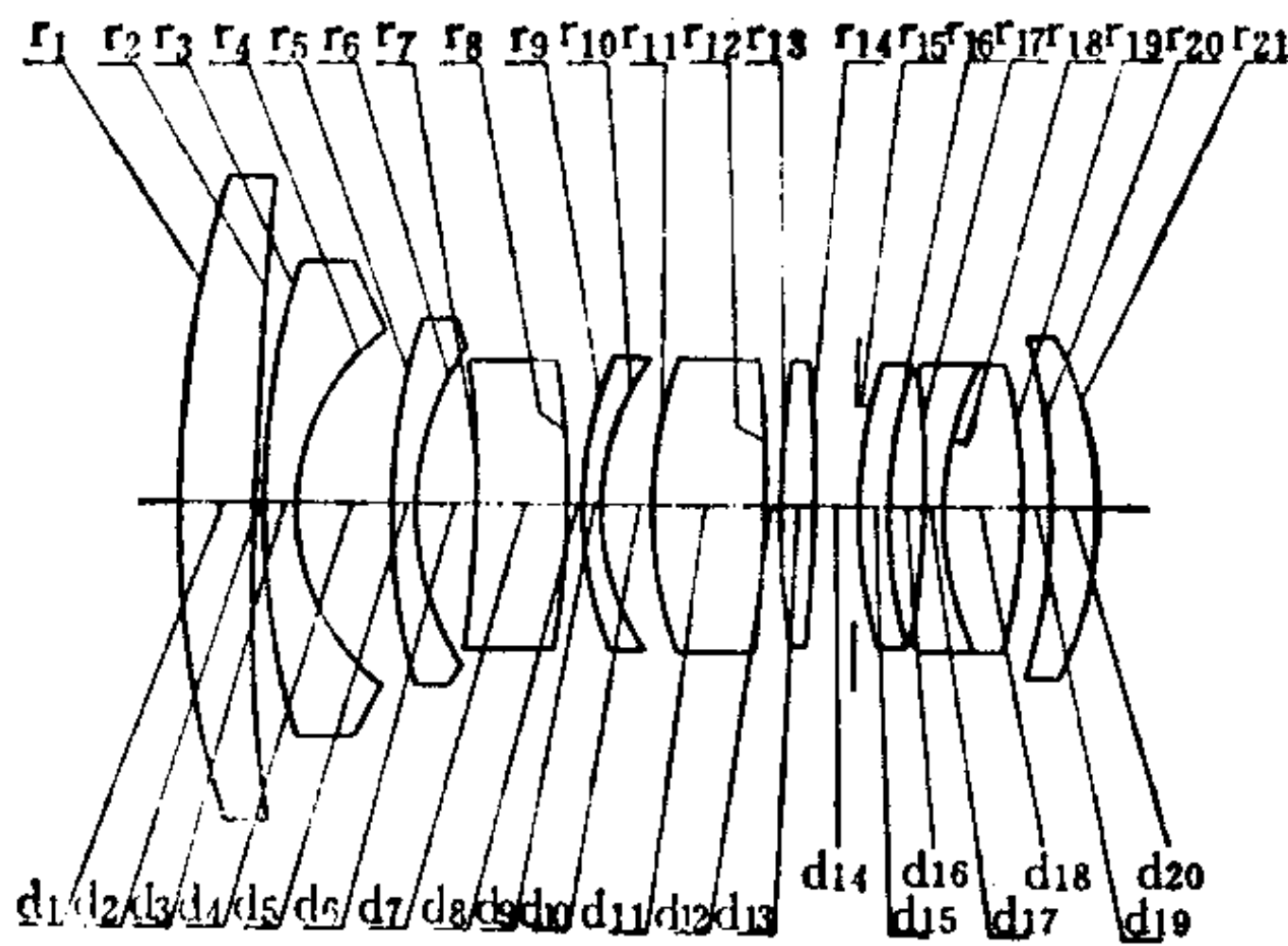

序号	r	d	n	v	序号	r	d	n	v
1	2.9788	0.1850	1.69680	55.8	12	-41.6475	0.0200		
2	9.6126	0.0039			13	3.0291	0.0969	1.56873	63.2
3	1.7523	0.0818	1.61800	63.0	14	-8.2265	0.1324*		
4	0.5683	0.2531			15	2.6760	0.0662	1.80518	25.2
5	2.3818	0.0600	1.63854	55.7	16	1.2060	0.0807		
6	0.7262	0.1404			17	-9.2062	0.0500	1.80750	35.4
7	-325.4129	0.2378	1.76182	26.3	18	0.9022	0.2000	1.60311	60.9
8	-4.9327	0.0050			19	-1.0544	0.0039		
9	0.9649	0.0633	1.7745	50.6	20	-5.5427	0.1300	1.61800	63.0
10	0.6444	0.1039			21	-0.9747			
11	0.8746	0.2905	1.70154	41.1					

0.1324* = 0.0662 + 0.0662

	ΣS_1	ΣS_2	ΣS_3	ΣS_4	ΣS_5	HI	QP(1 ω)
	-0.00185	0.00071	-0.00023	-0.00205	-0.01512	1	-1.9%
h 或 ω %	LA'	$\Delta H'$	x'_t	x'_s	$x'_t - x'_s$	K'_{T1}	$K'_{T0.7}$
100	-0.00092	-0.01993	-0.00805	0.00741	-0.01546	-0.00135	-0.00080
70	-0.00855	-0.02056	-0.01298	-0.01612	0.00314	-0.00041	-0.00042

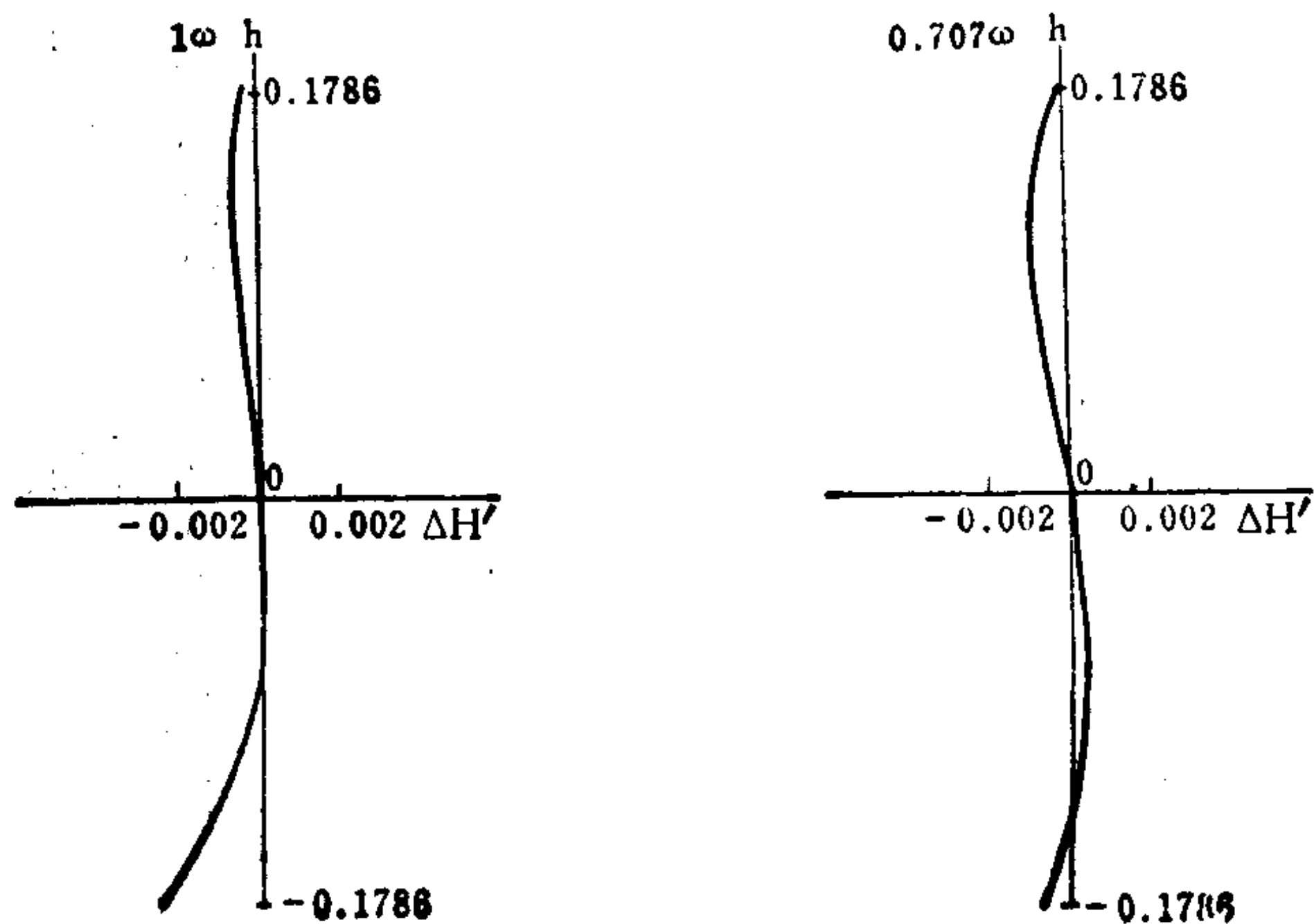
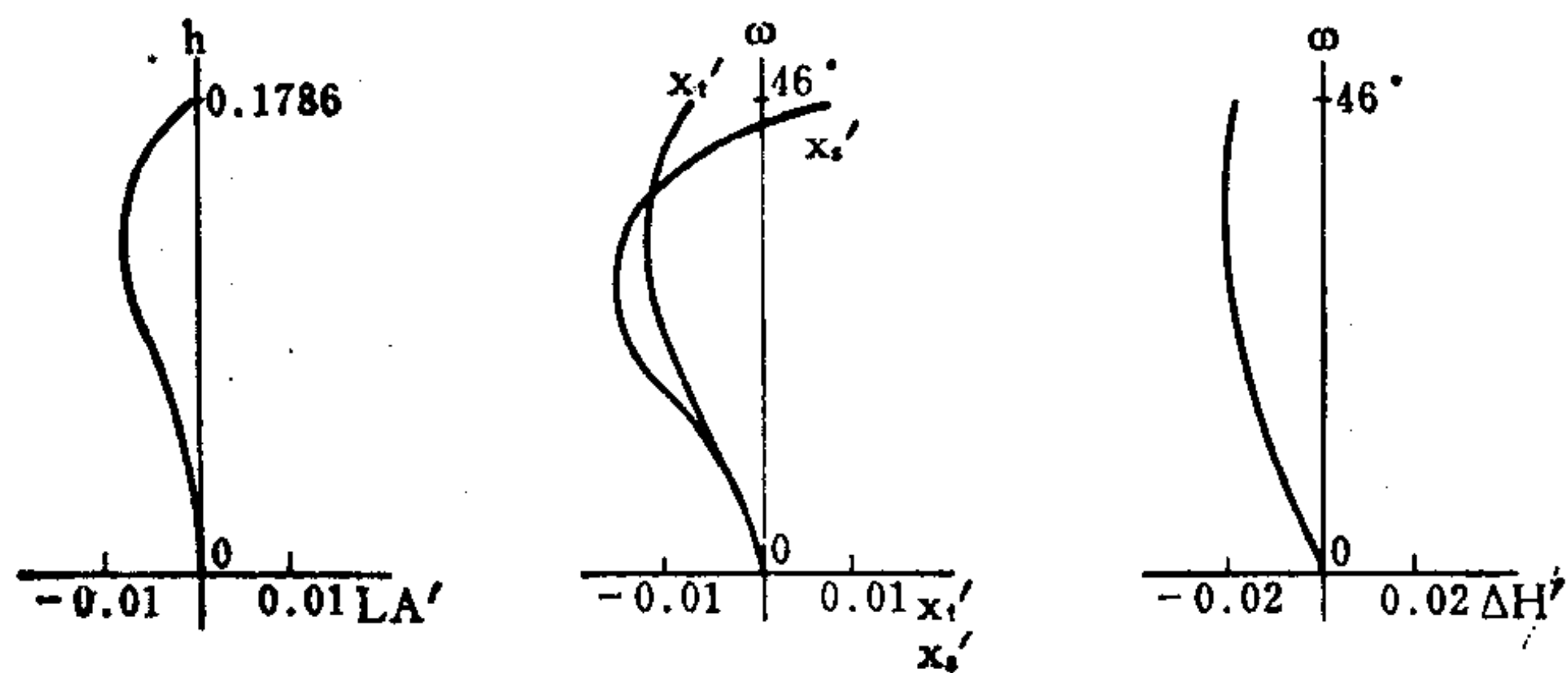

编号: 07-02-051

反远距型超广角物镜

E. F. L = 1

B. F. L = 1.76

FNo. = 2.8

F. A. = ± 46°

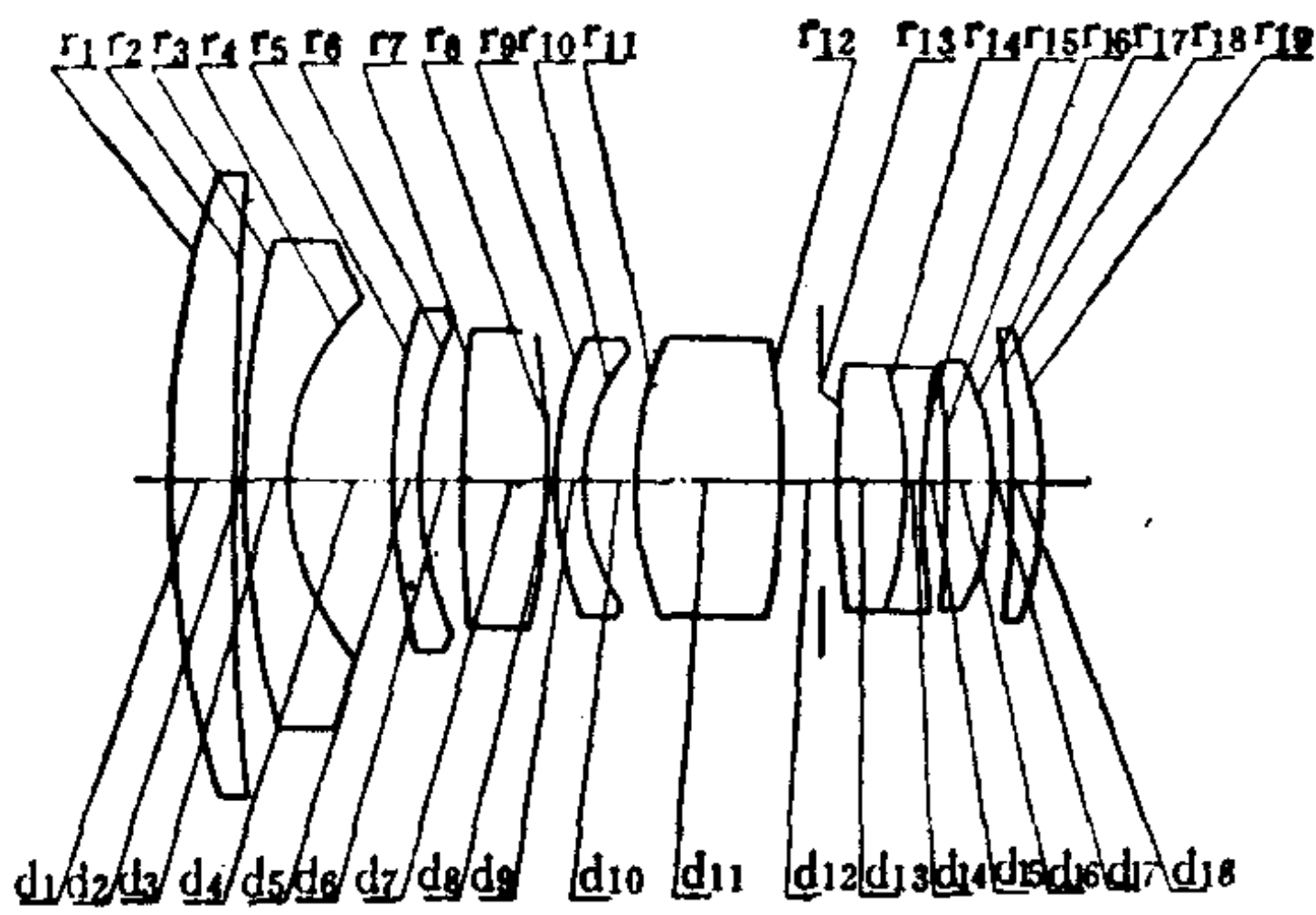

序号	r	d	n	v	序号	r	d	n	v
1	2.5552	0.1850	1.72000	52.5	11	0.8306	0.3912	1.66998	39.2
2	6.8380	0.0039			12	-2.5099	0.1465*		
3	2.0441	0.0976	1.63880	60.0	13	6.6187	0.1692	1.62004	36.3
4	0.5834	0.2844			14	-1.0407	0.0678	1.80518	25.2
5	1.8802	0.0600	1.60311	60.9	15	1.5955	0.0569		
6	0.8445	0.1088			16	-5.6633	0.1250	1.62135	61.3
7	55.6902	0.2317	1.68893	31.0	17	-0.7285	0.0039		
8	-5.8786	0.0050			18	-5.4685	0.0846	1.63880	60.0
9	1.1095	0.0633	1.74950	50.4	19	-1.3381			
10	0.5670	0.1137							

$0.1465^* = 0.0735 + 0.0730$

	ΣS_1	ΣS_2	ΣS_3	ΣS_4	ΣS_5	HI	QP(1 ω)
	-0.00205	0.00134	-0.00075	-0.00207	-0.01442	1	-2.7%
h 或 ω %	LA'	$\Delta H'$	x'_t	x'_a	$x'_t - x'_a$	K'_{T1}	$K'_{T0.7}$
100	0.00286	-0.02803	0.00480	0.00061	0.00419	-0.00259	-0.00134
70	-0.00737	-0.02022	-0.01232	-0.01608	0.00376	-0.00036	-0.00002

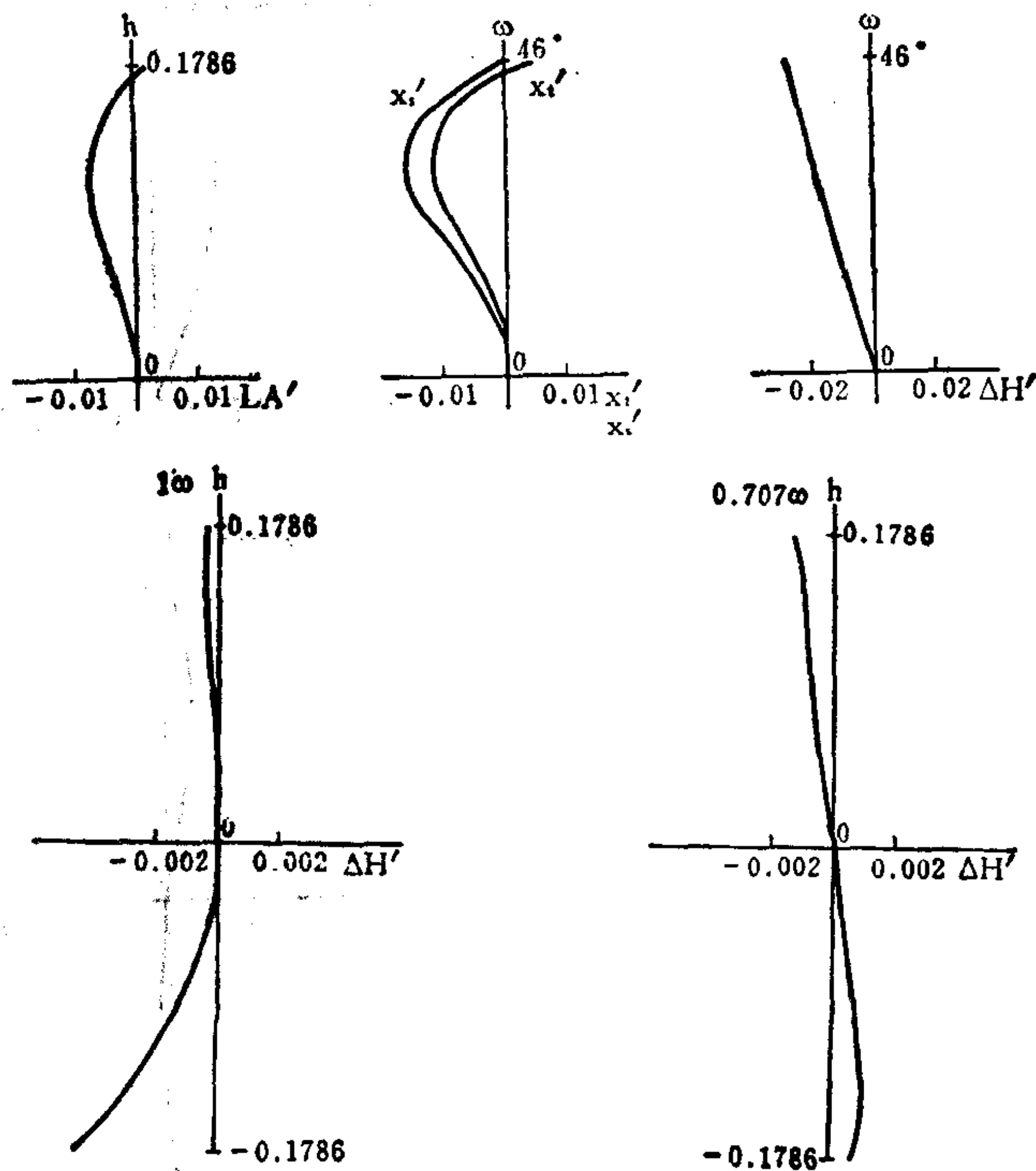

编号: 07-02-052

反远距型广角照相物镜

E. F. L = 100

B. F. L = 107.29

FNo. = 2.8

F. A. = ± 31°

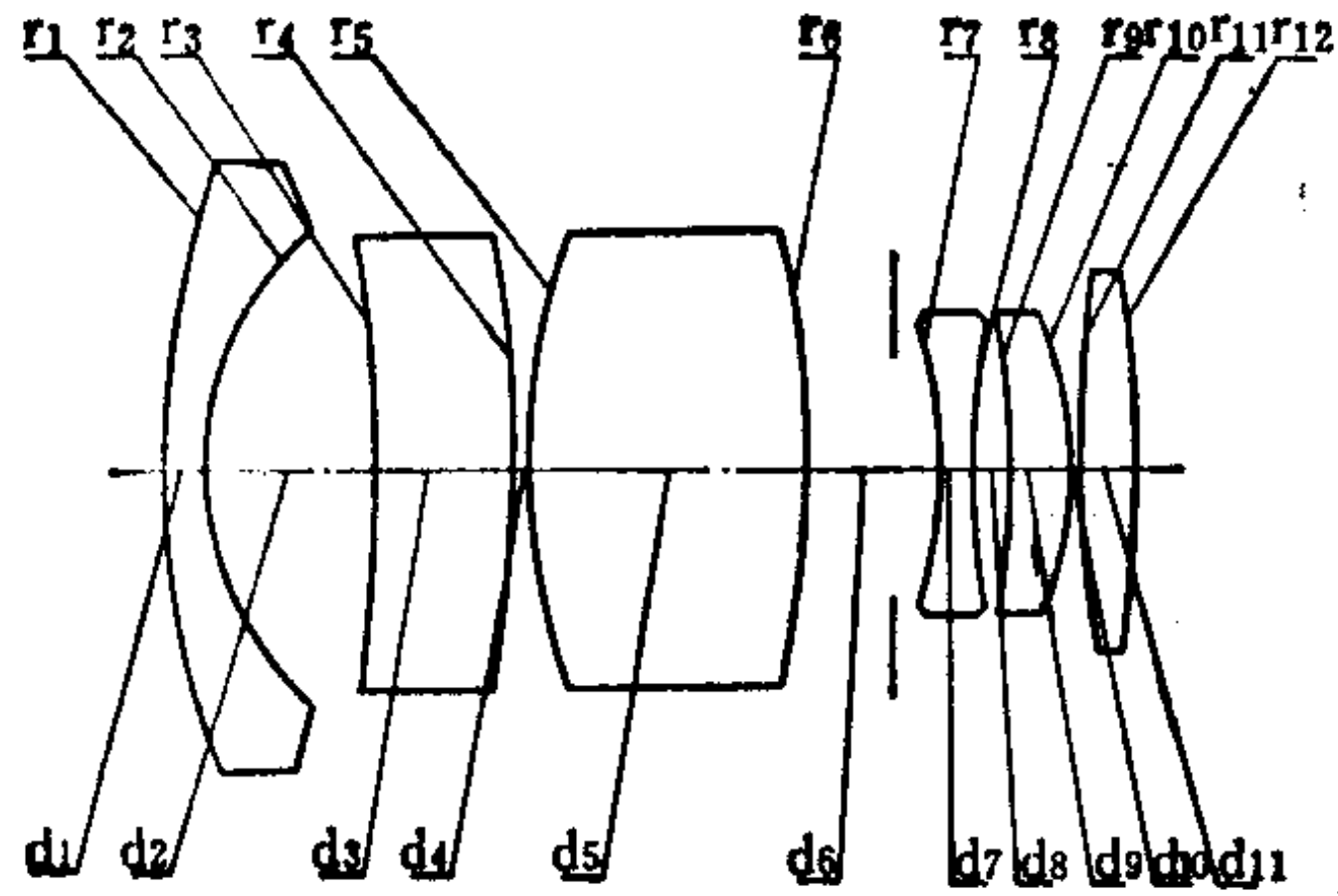

序号	r	d	n	v_d	序号	r	d	n	v_d
1	133.333	5.556	1.51454	54.6	7	-59.028	4.167	1.71736	29.5
2	42.083	22.222			8	116.667	3.750		
3	-258.333	27.778	1.51680	64.2	9	-123.611	7.500	1.74443	49.4
4	-233.333	0.278			10	-49.167	0.278		
5	73.056	37.500	1.71300	53.9	11	277.778	6.944	1.62041	60.3
6	-133.889	17.222*			12	-188.669			

17.222* = 8.611 + 8.611

	ΣS_1	ΣS_2	ΣS_3	ΣS_4	ΣS_5	HI	QP(1 ω)
	-0.0891	0.0238	0.0129	-0.1184	-0.2210	60	-0.39%
h 或 ω %	LA'	$\Delta H'$	x'_t	x'_s	$x'_t - x'_s$	K'_{T1}	$K'_{T0.7}$
100	-0.317	-0.235	-2.249	-0.366	-1.883	-0.8355	-0.1104
70	-0.486	-0.191	-0.771	-0.654	-0.117	-0.3861	-0.0490

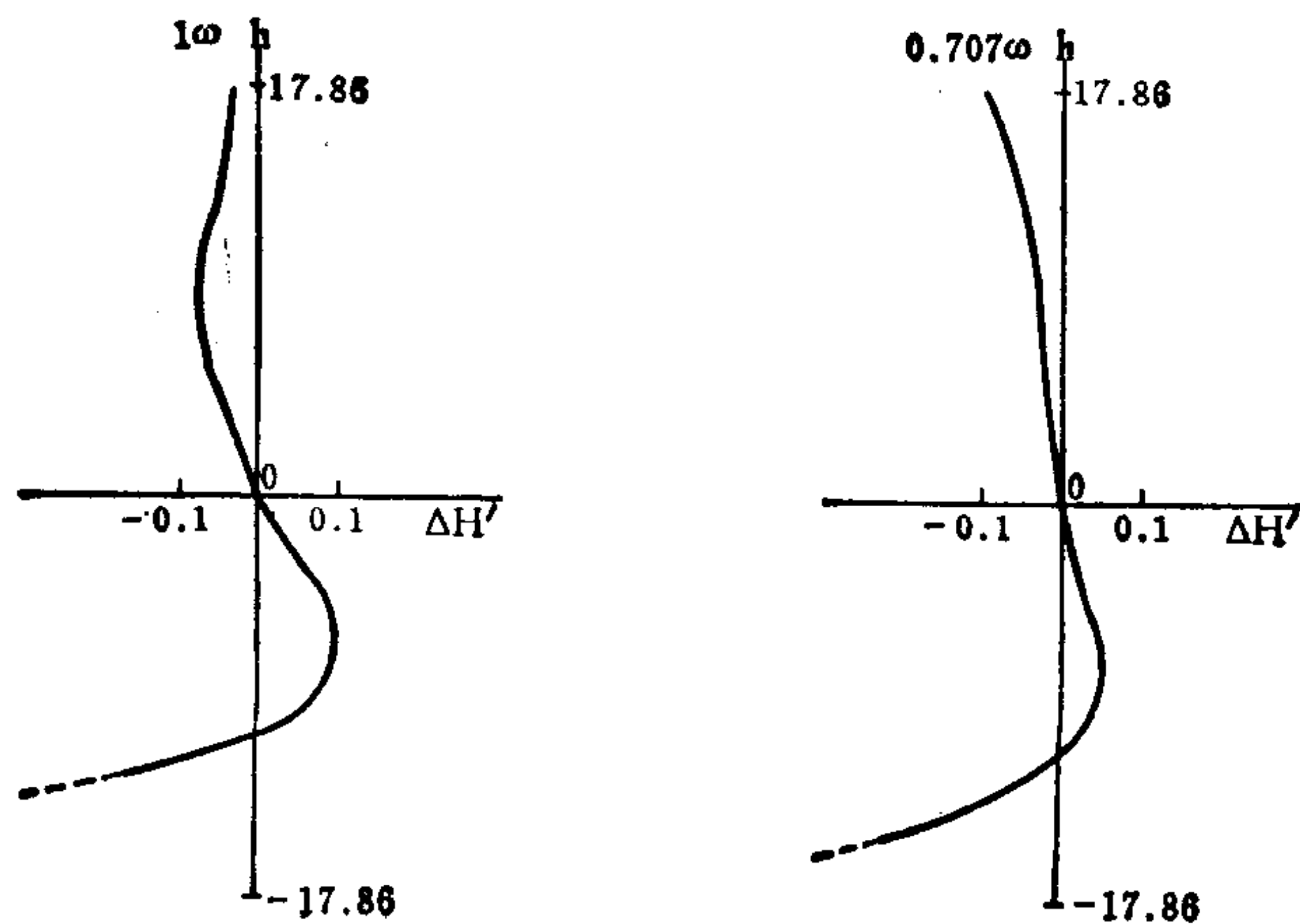
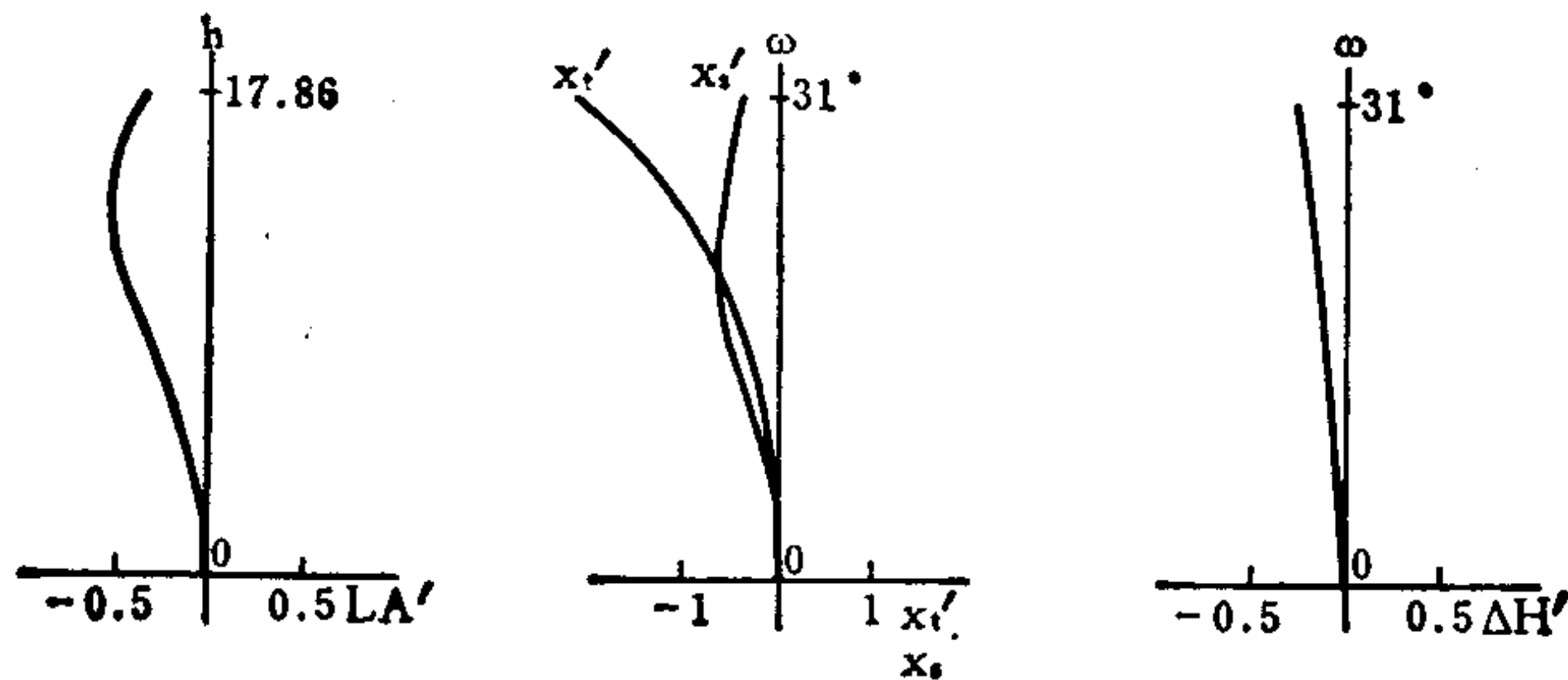

编号: 07-02-053

反远距型广角照相物镜

E. F. L = 100

B. F. L = 107.7

FNo. = 2

F. A. = ± 31°

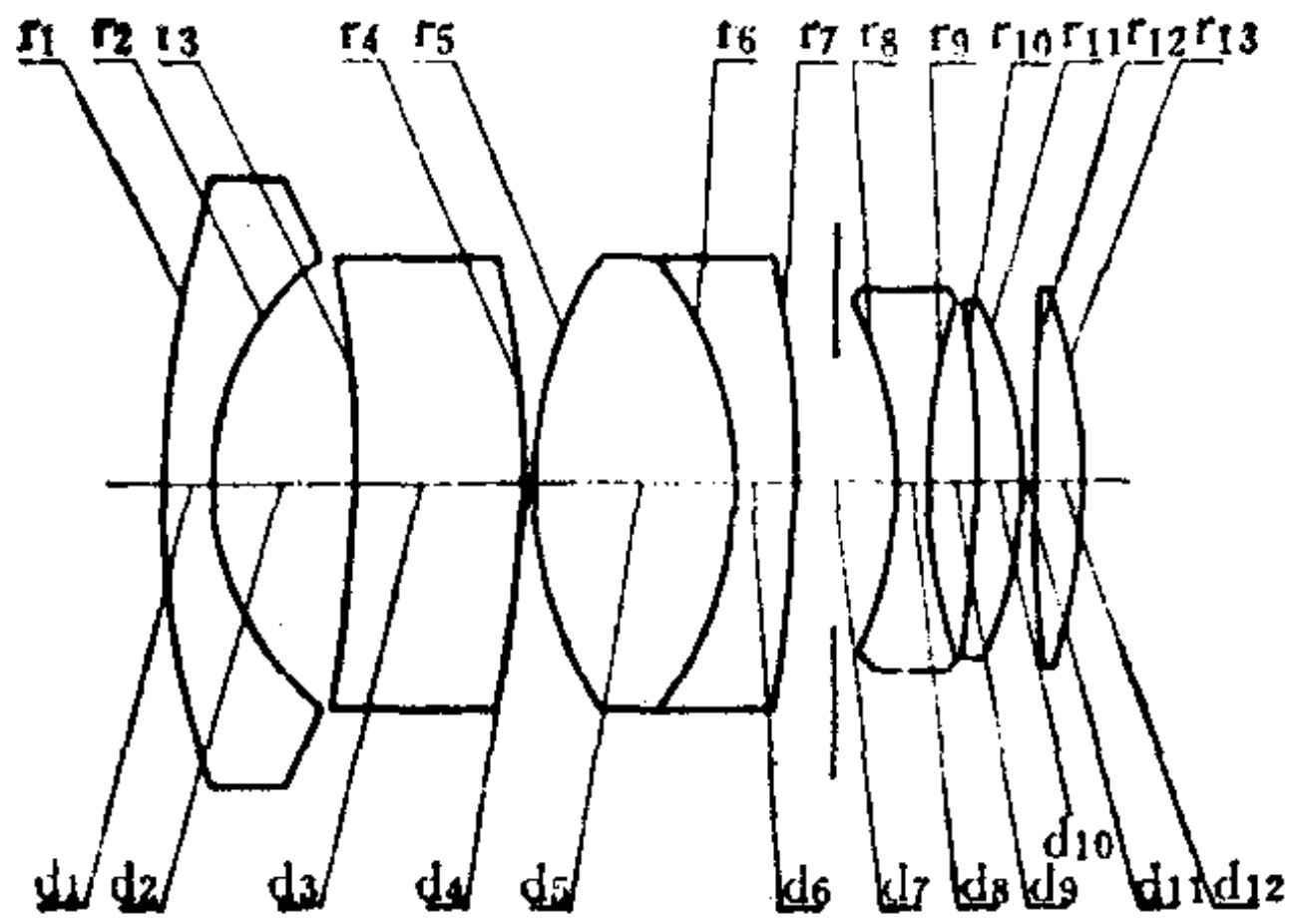

序号	r	d	n	v_d	序号	r	d	n	v_d
1	186.111	8.333	1.51680	64.2	8	-65.694	5.000	1.71736	29.5
2	48.889	23.611			9	131.944	6.944		
3	-240.833	30.000	1.63854	55.5	10	-176.389	8.333	1.71300	53.9
4	-174.167	0.278			11	-61.111	0.278		
5	83.333	31.944	1.71300	53.9	12	472.222	7.778	1.62041	60.3
6	-61.111	12.222	1.62012	49.8	13	-111.708			
7	-283.333	18.056*							

$18.056^* = 9.028 + 9.028$

	ΣS_1	ΣS_2	ΣS_3	ΣS_4	ΣS_5	HI	QP (1 ω)
	-0.2388	0.0224	0.0266	-0.2552	-0.4873	60	-1.1%
h 或 ω %	LA'	$\Delta H'$	x'_t	x'_s	$x'_t - x'_s$	K'_{T1}	$K'_{T0.7}$
100	0.015	-0.703	-2.241	-0.050	-2.191	1.4119	-0.0733
70	-0.464	-0.347	-0.797	-0.655	-0.142	0.7425	-0.0413

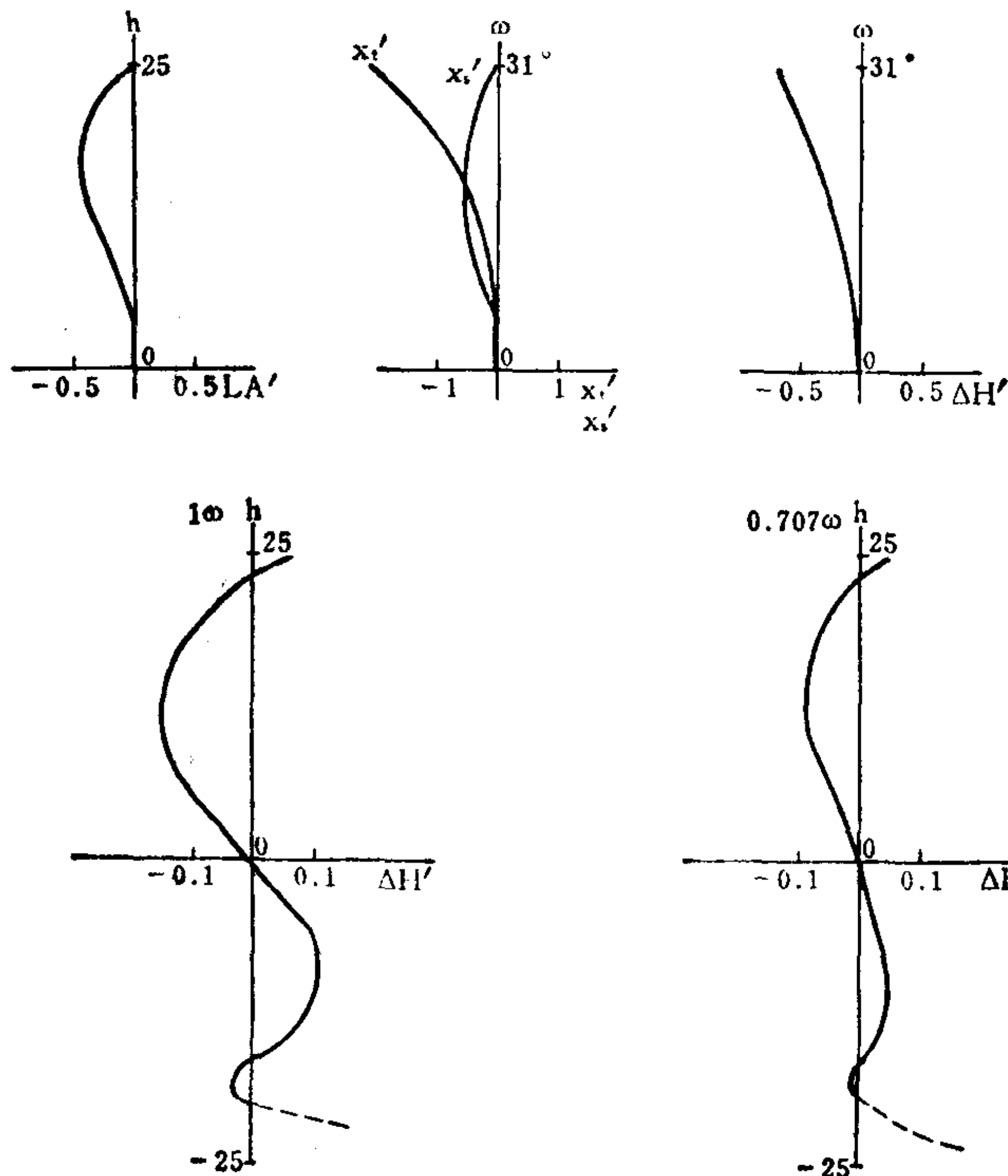

编号: 07-02-054

超广角大孔径照相物镜

E. F. L = 99.92

B. F. L = 155.09

FNo. = 2

F. A. = ± 42°

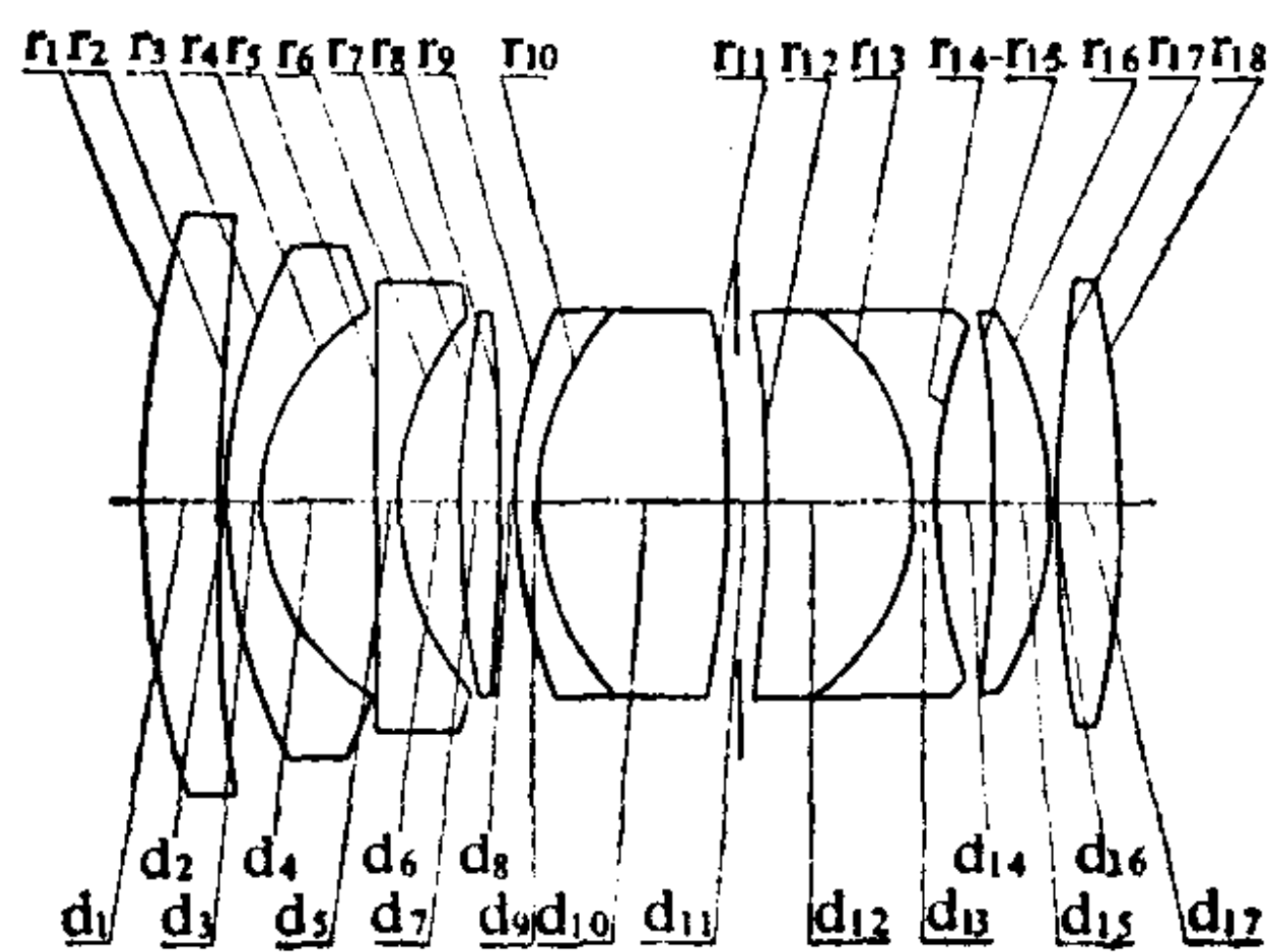

序号	r	d	n	v	序号	r	d	n	v
1	204.057	18.27	1.744	44.8	10	64.249	44.08	1.603	38.0
2	626.767	0.82			11	-316.204	10.61*		
3	138.494	7.35	1.603	60.7	12	-2779.380	32.24	1.773	49.7
4	52.127	26.12			13	-55.363	8.16	1.699	30.1
5	∞	6.12	1.603	60.7	14	175.571	12.25		
6	67.098	12.24			15	-246.812	12.25	1.697	55.6
7	233.682	9.80	1.516	56.8	16	-88.820	0.82		
8	-633.159	0.82			17	339.233	15.51	1.670	57.3
9	111.159	6.12	1.773	49.7	18	-239.616			

10.61* = 5.30 + 5.31

	ΣS_1	ΣS_2	ΣS_3	ΣS_4	ΣS_5	HI	QP(1 ω)
	-0.2571	0.0389	0.1064	-0.3467	-1.7156	89.9	-2.4%
h 或 ω %	LA'	$\Delta H'$	x'_t	x'_s	$x'_t - x'_s$	K'_{T1}	$K'_{T0.7}$
100	-0.162	-2.219	-1.018	0.573	-1.591	0.0317	0.0097
70	-0.508	-1.440	-0.364	-0.883	0.519	-0.0423	-0.0165

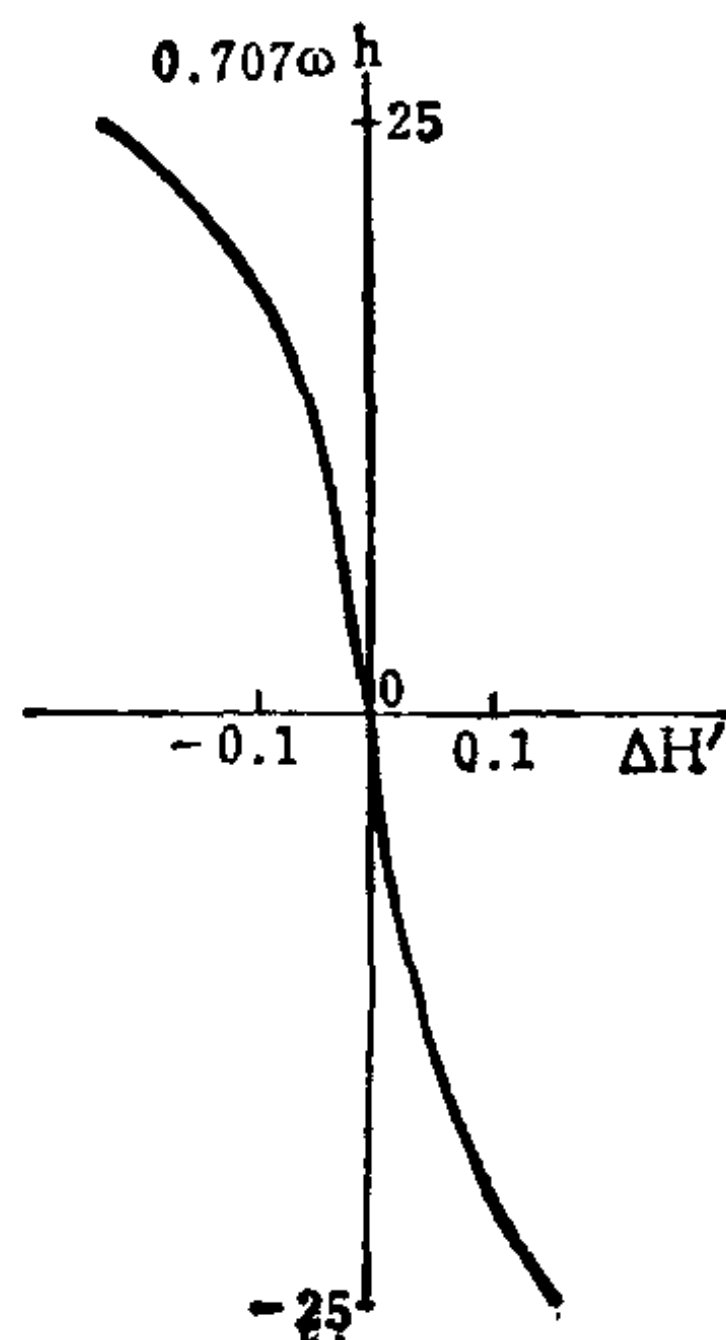
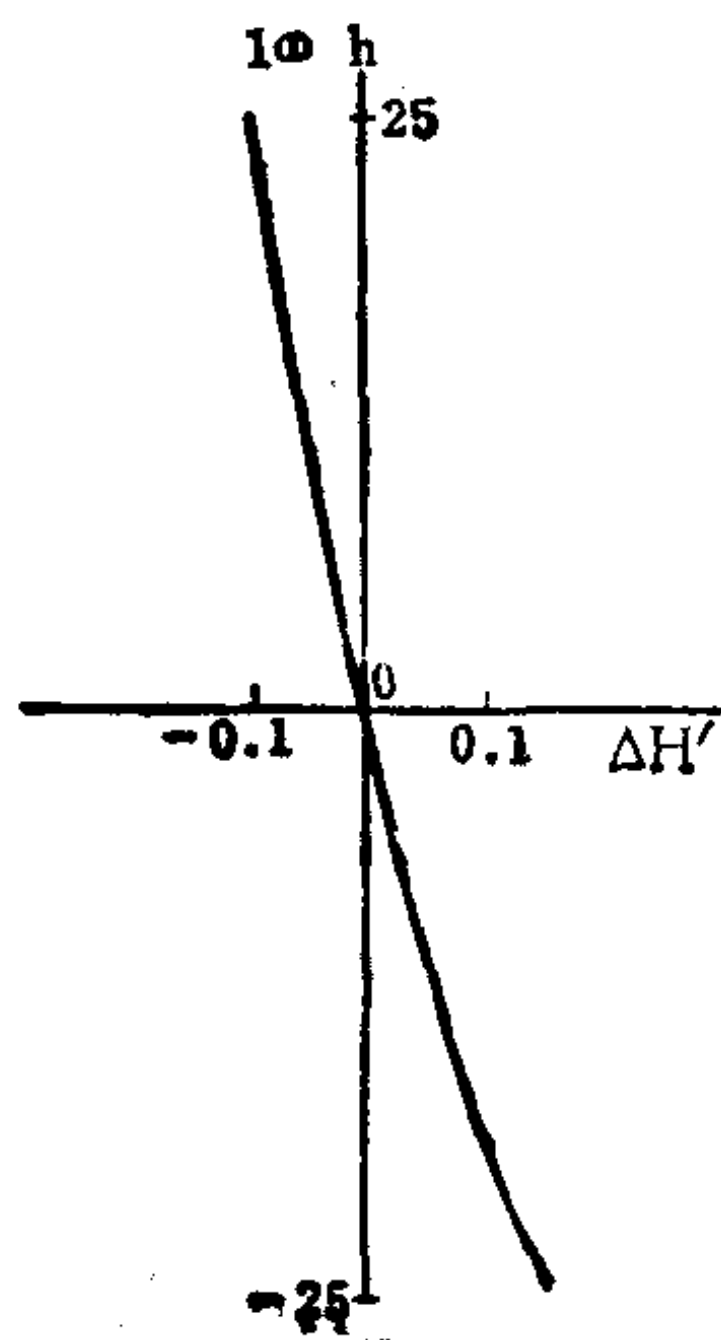
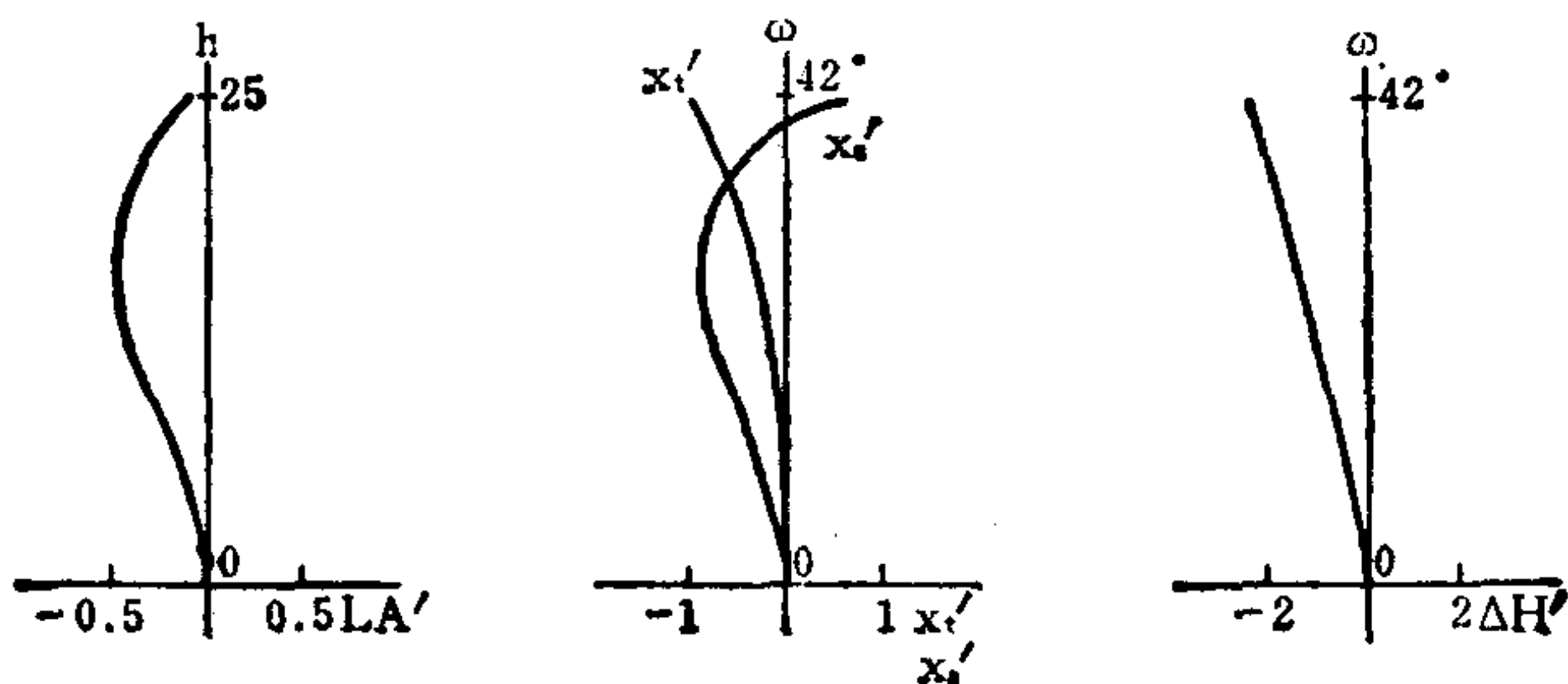

编号: 07-02-055

超广角大孔径照相物镜

E. F. L = 99.92

B. F. L = 155.05

FNo. = 2

F. A. = $\pm 42^\circ$

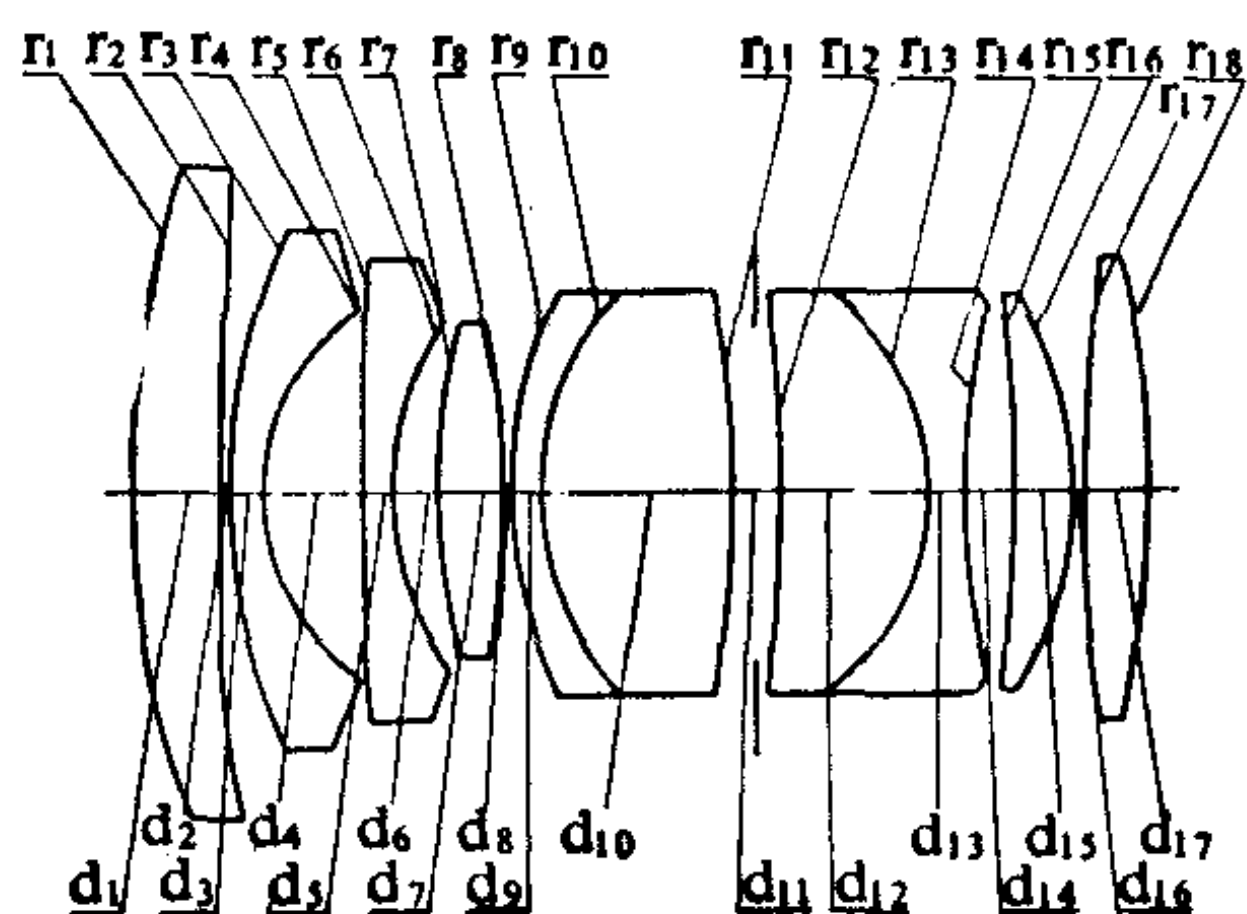

序号	r	d	n	v	序号	r	d	n	v
1	204.5330	20.41	1.762	40.2	10	67.1650	44.90	1.603	38.0
2	588.8364	0.82			11	-273.8570	10.20*		
3	142.0180	7.35	1.603	60.7	12	-581.7270	32.65	1.773	49.7
4	51.4660	23.67			13	-55.1050	8.16	1.699	30.1
5	1137.9470	6.12	1.603	60.7	14	193.1770	11.43		
6	68.3330	10.20			15	-285.1080	13.06	1.697	55.6
7	237.8820	14.29	1.518	58.9	16	-92.0580	0.82		
8	-803.8590	0.82			17	361.5230	15.51	1.697	55.6
9	112.0740	6.12	1.773	49.7	18	-233.8380			

10.20* = 5.10 + 5.10

	ΣS_1	ΣS_2	ΣS_3	ΣS_4	ΣS_5	HI	QP(1 ω)
	-0.2504	0.0658	0.0883	-0.3518	-1.7122	89.9	-2.4%
h 或 ω %	LA'	$\Delta H'$	x'_i	x'_s	$x'_i - x'_s$	K'_{T1}	$K'_{T0.7}$
100	-0.299	-2.177	-1.236	0.647	-1.883	-0.0341	-0.0254
70	-0.537	-1.442	-0.325	-0.886	0.561	0.0066	-0.0040

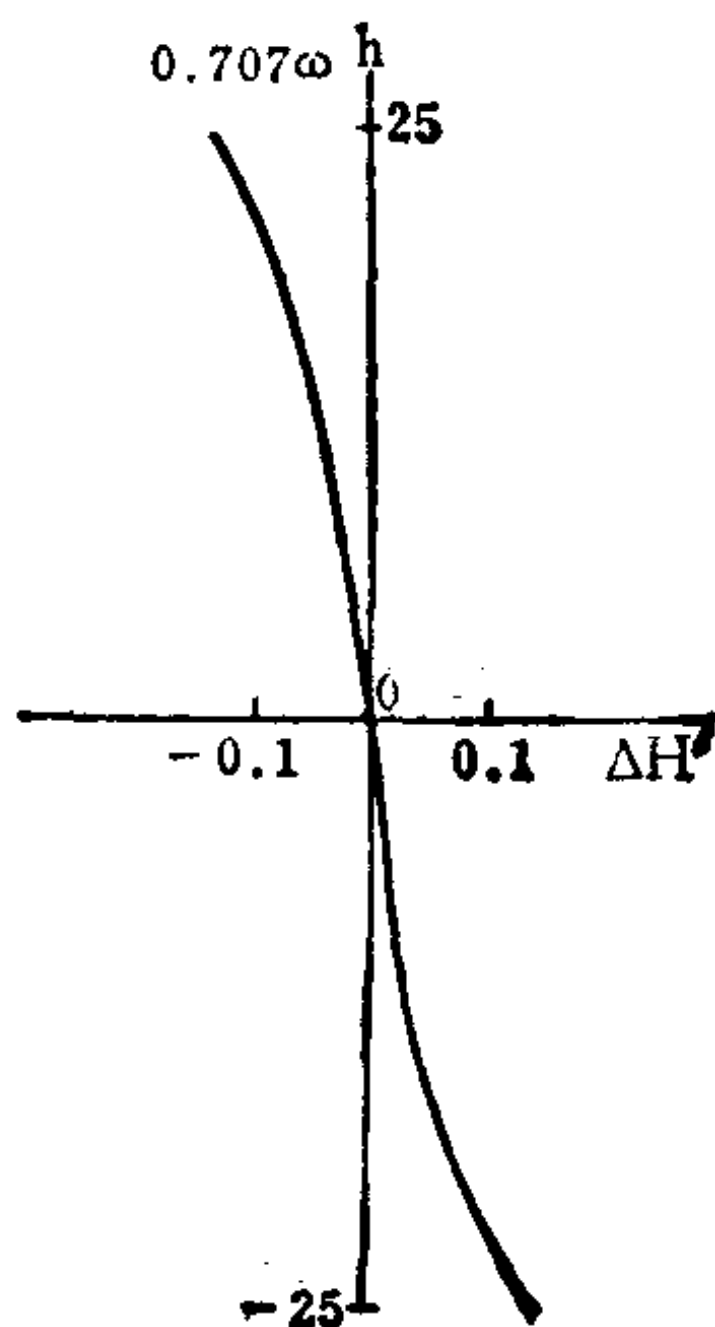
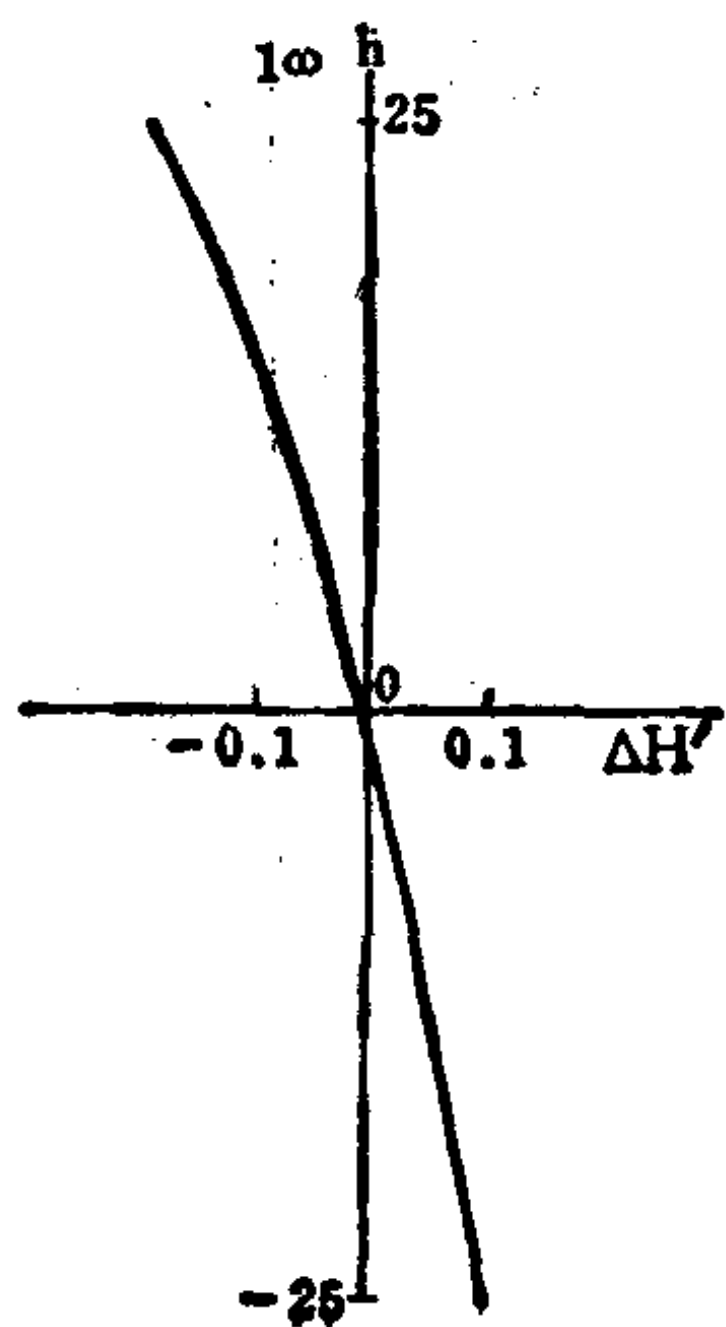
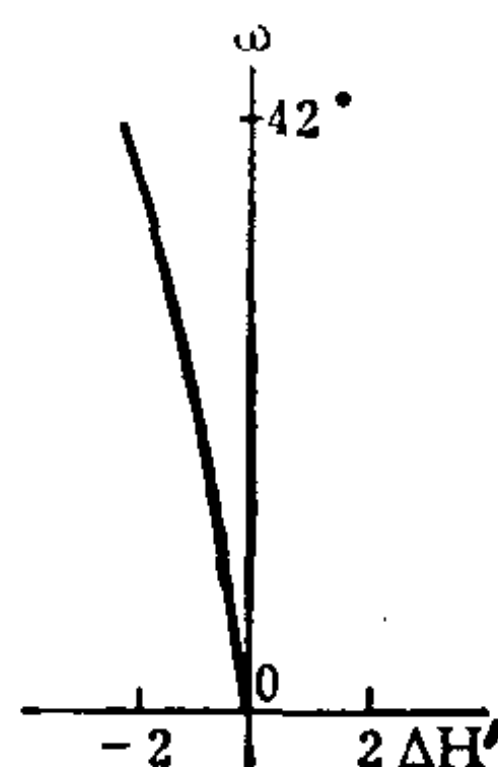
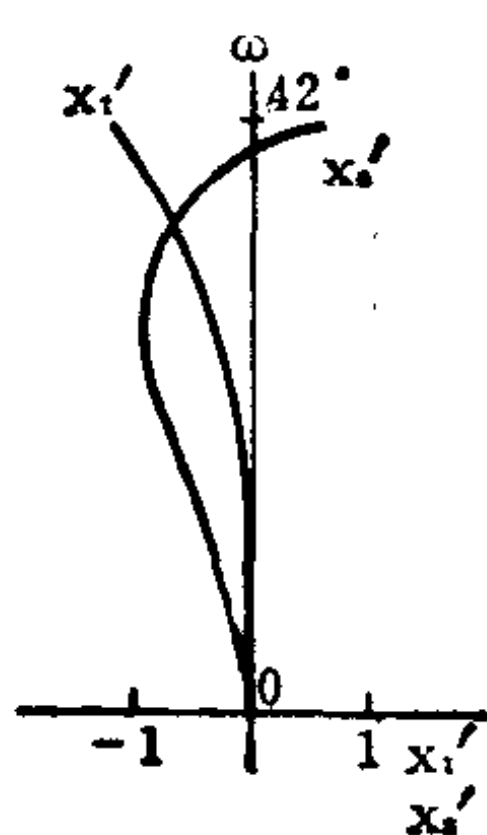
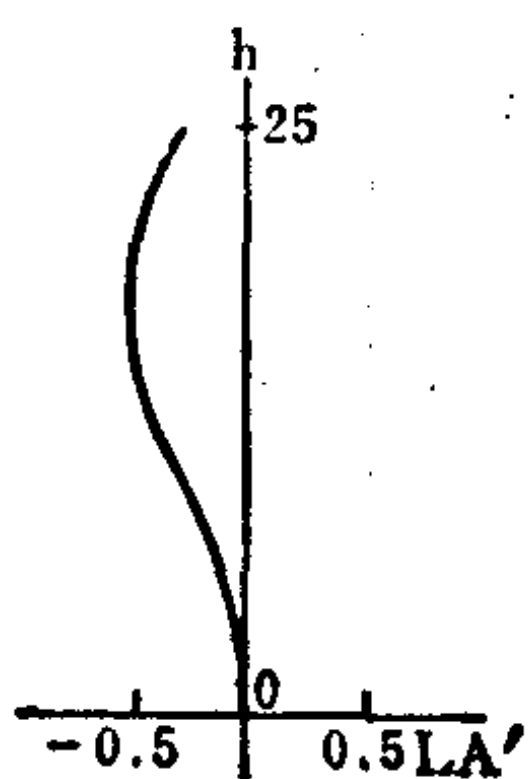

编号: 07-02-056

超 广 角 物 镜

E. F. L = 1

B. F. L = 0.699

FNo. = 5.6

F. A. = $\pm 45^\circ$

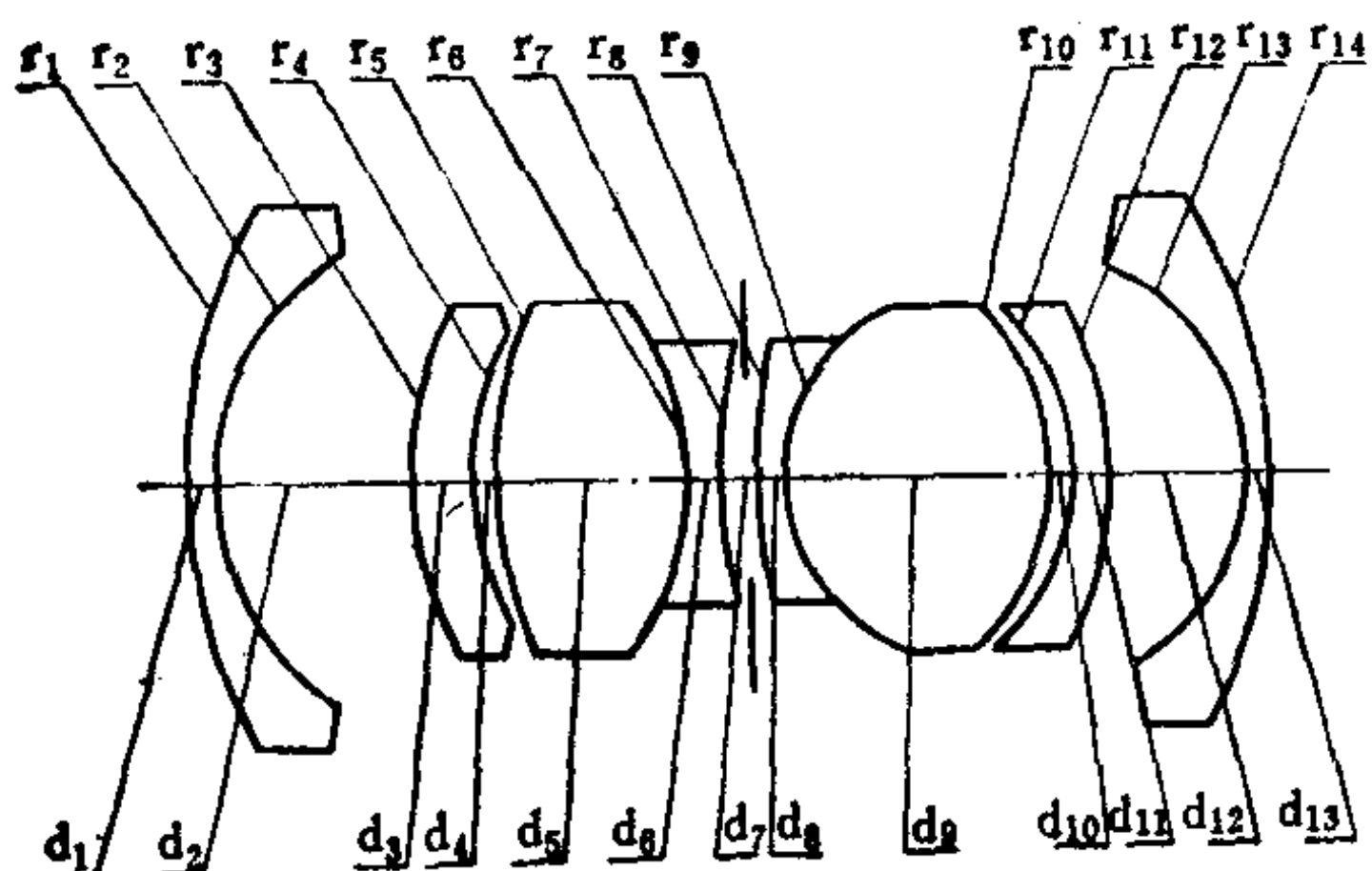

序号	r	d	n	v	序号	r	d	n	v
1	0.79288	0.04000	1.64250	58.1	8	11.62790	0.04000	1.52310	50.9
2	0.37861	0.27883			9	0.25999	0.38300	1.65160	58.5
3	0.61421	0.04600	1.56883	56.0	10	-0.36065	0.00940		
4	0.42827	0.02337			11	-0.32931	0.06500	1.72825	28.3
5	0.64523	0.28400	1.65844	50.8	12	-0.51539	0.17021		
6	-0.42074	0.04000	1.54814	45.9	13	-0.31487	0.04000	1.65844	50.8
7	4.08163	0.06500*			14	-0.70658			

0.06500* = 0.03250 + 0.03250

	ΣS_1	ΣS_2	ΣS_3	ΣS_4	ΣS_5	HI	QP(1 ω)
	0.000049	0.000037	-0.000188	0.000026	-0.002843	1	-2.9%
h 或 ω %	LA'	$\Delta H'$	x'_t	x'_s	$x'_t - x'_s$	K'_{T1}	$K'_{T0.7}$
100	0.000062	-0.02888	-0.05929	-0.01581	-0.04348	-0.00547	-0.00123
70	0.000952	-0.00877	-0.02233	-0.00743	-0.01490	-0.00119	-0.00005

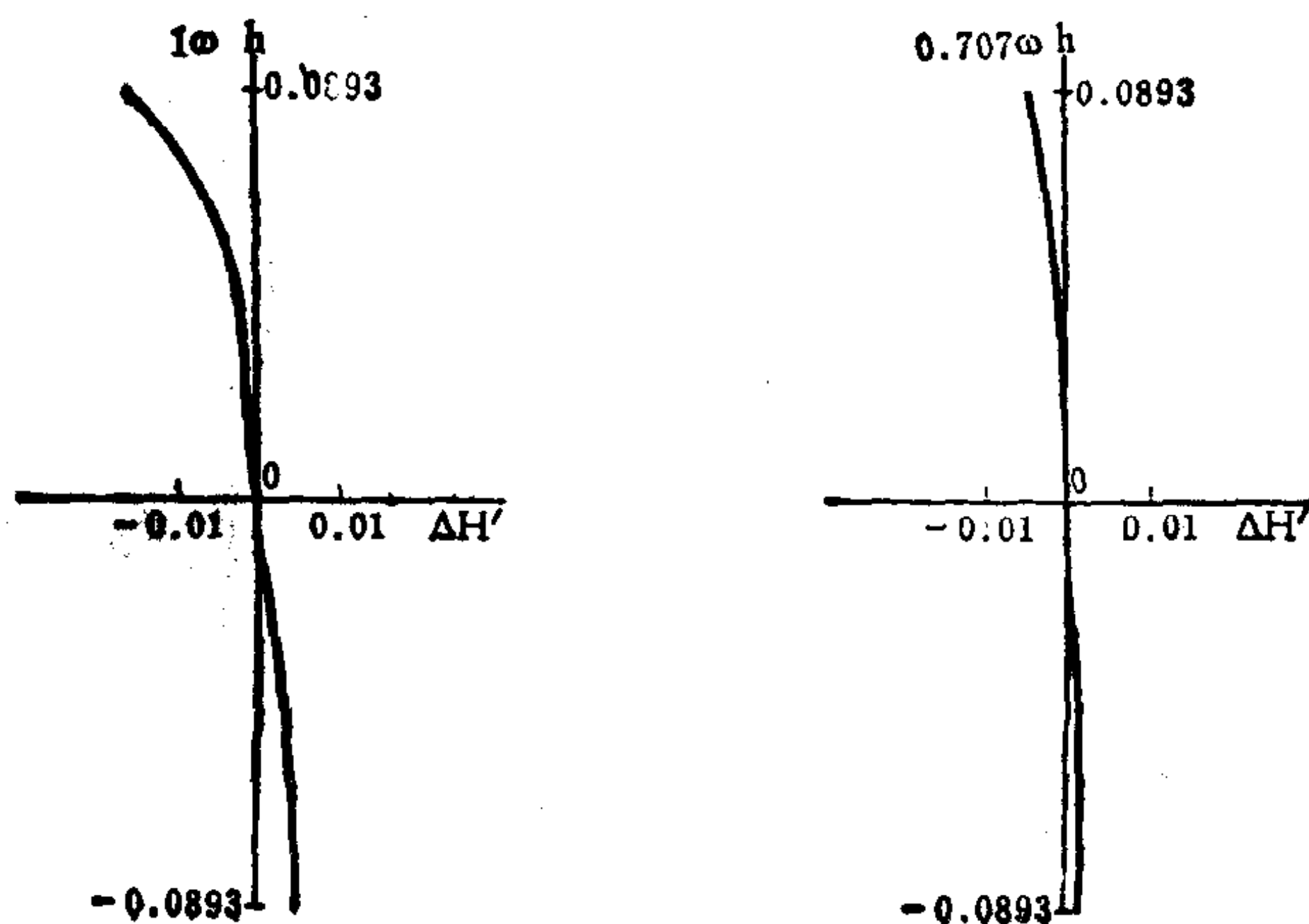
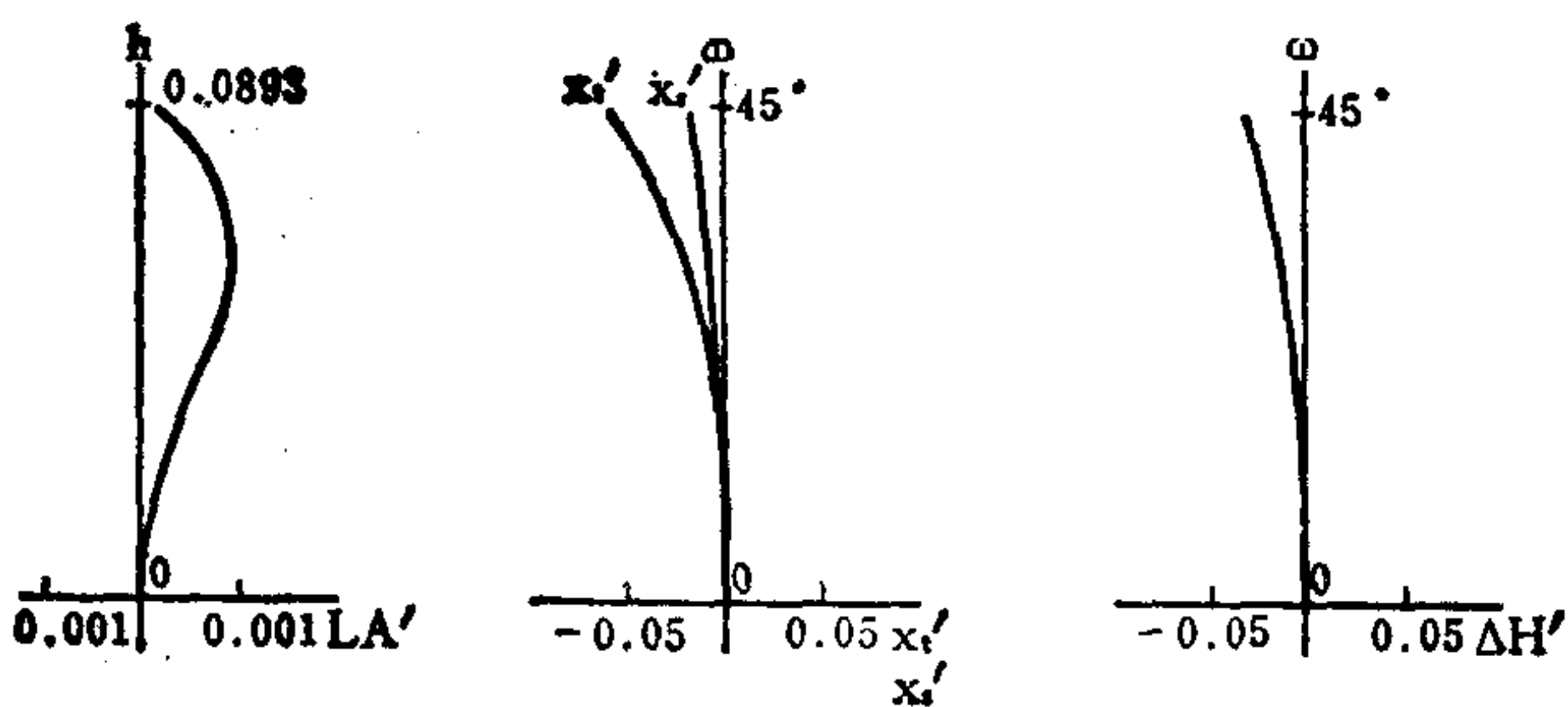

编号: 07-02-057

反远距型广角物镜

E. F. L = 1

B. F. L = 1.560

FNo. = 2.8

F. A. = ± 42°

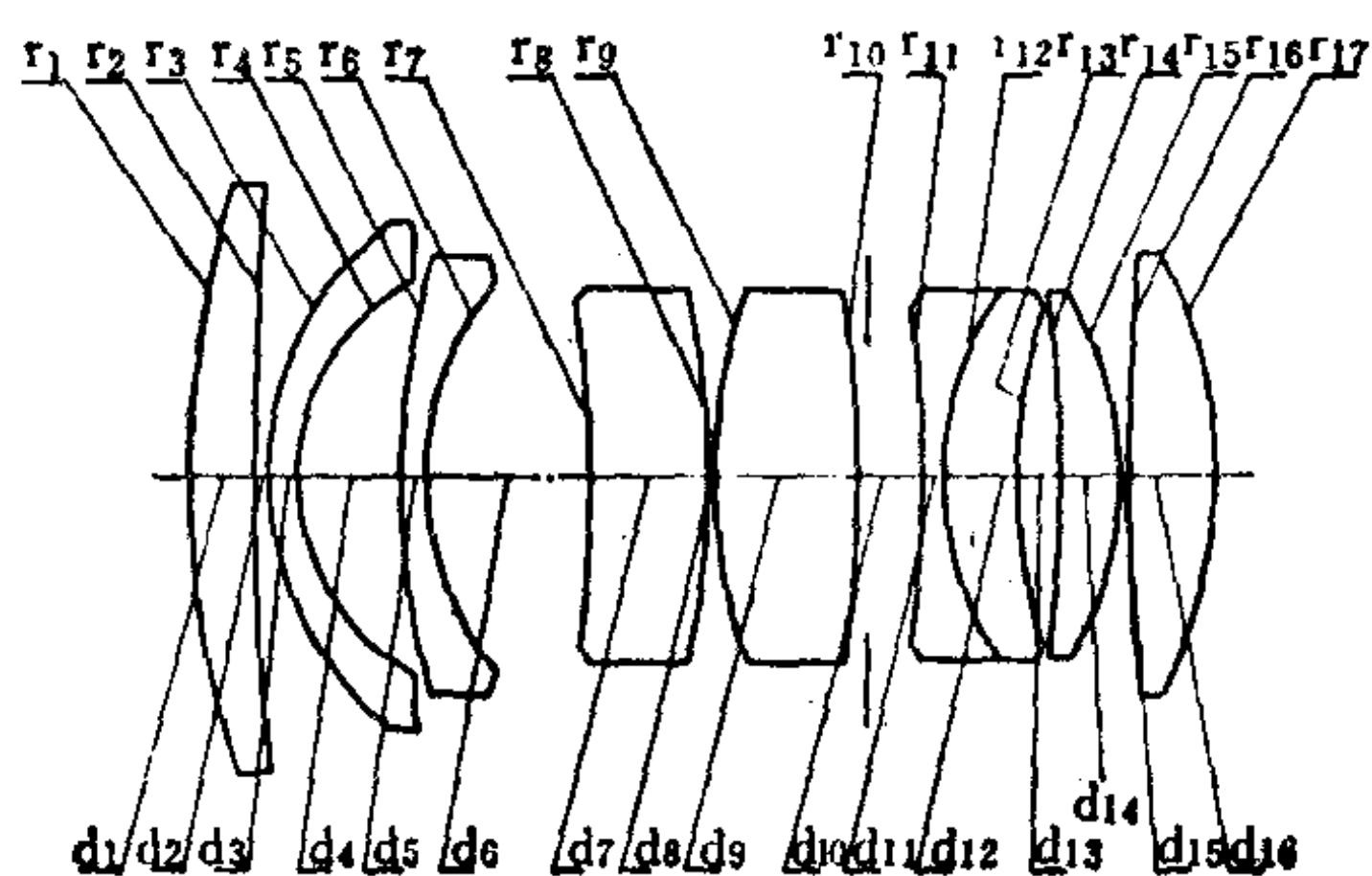

序号	r	d	n	v	序号	r	d	n	v
1	1.53019	0.12	1.60717	40.2	10	-4.52667	0.11*		
2	3.40700	0.01			11	-1.96067	0.05	1.76182	26.5
3	0.55556	0.05	1.69350	53.4	12	0.66973	0.12	1.77252	49.6
4	0.37037	0.18			13	1.60718	0.06		
5	1.35156	0.04	1.69350	53.4	14	-1.92023	0.10	1.62041	60.3
6	0.49290	0.16			15	-0.65381	0.01		
7	-3.33333	0.20	1.64769	33.9	16	8.31732	0.14	1.51633	64.0
8	-2.00000	0.01			17	-0.80738			
9	1.19210	0.24	1.72825	28.3					

0.11* = 0.04 + 0.07

	ΣS_1	ΣS_2	ΣS_3	ΣS_4	ΣS_5	HI	QP(1 ω)
	-0.001546	0.000517	-0.000090	-0.001815	-0.009823	0.9	-3%
h 或 ω %	LA'	$\Delta H'$	x'_t	x'_s	$x'_t - x'_s$	K'_{T1}	$K'_{T0.7}$
100	0.0115	-0.0270	0.0083	0.0091	-0.0008	-0.00251	-0.00165
70	-0.0056	-0.0127	-0.0121	-0.0115	-0.0006	0.00084	-0.00026

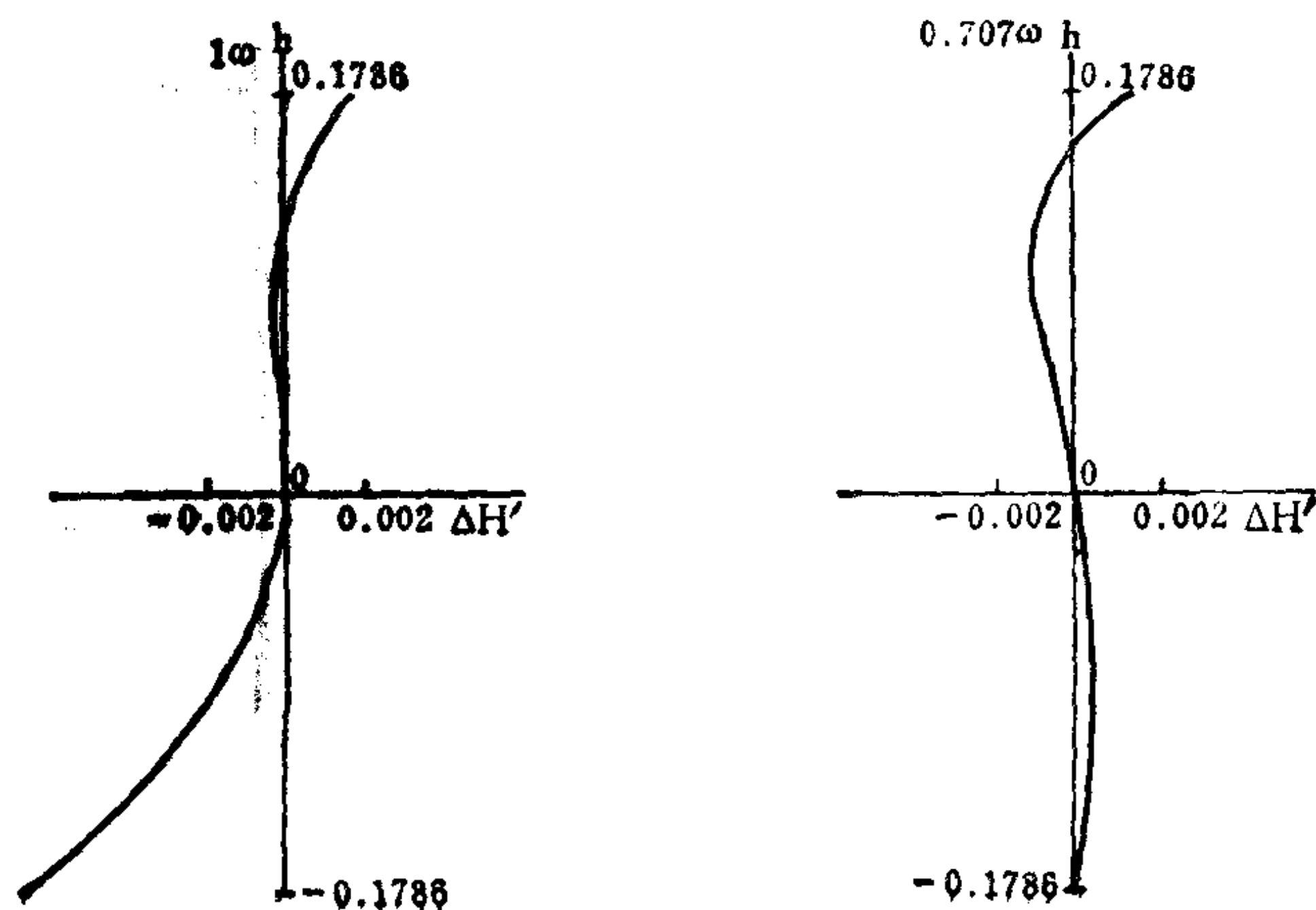
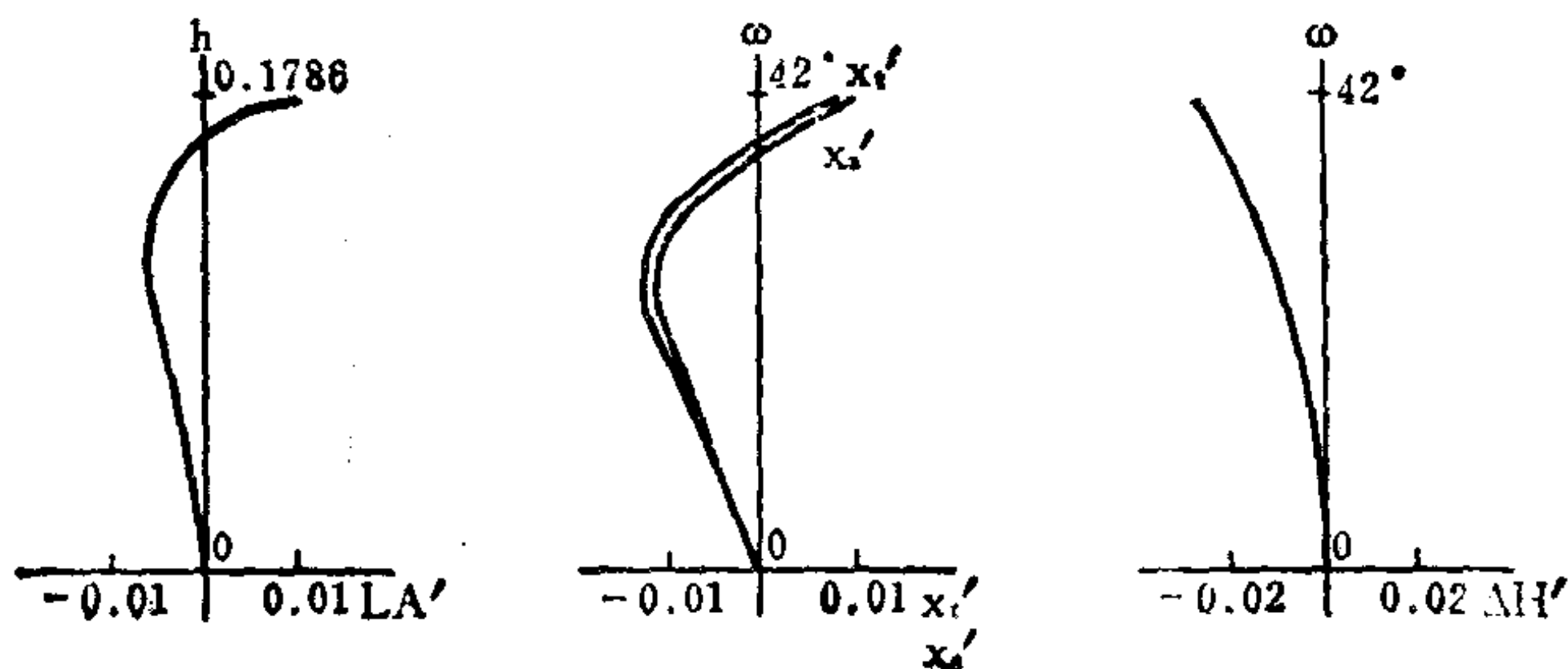

编号: 07-02-058

超广角大孔径照相物镜

E. F. L = 1

B. F. L = 1.7522

FNo. = 2

F. A. = ± 45.6°

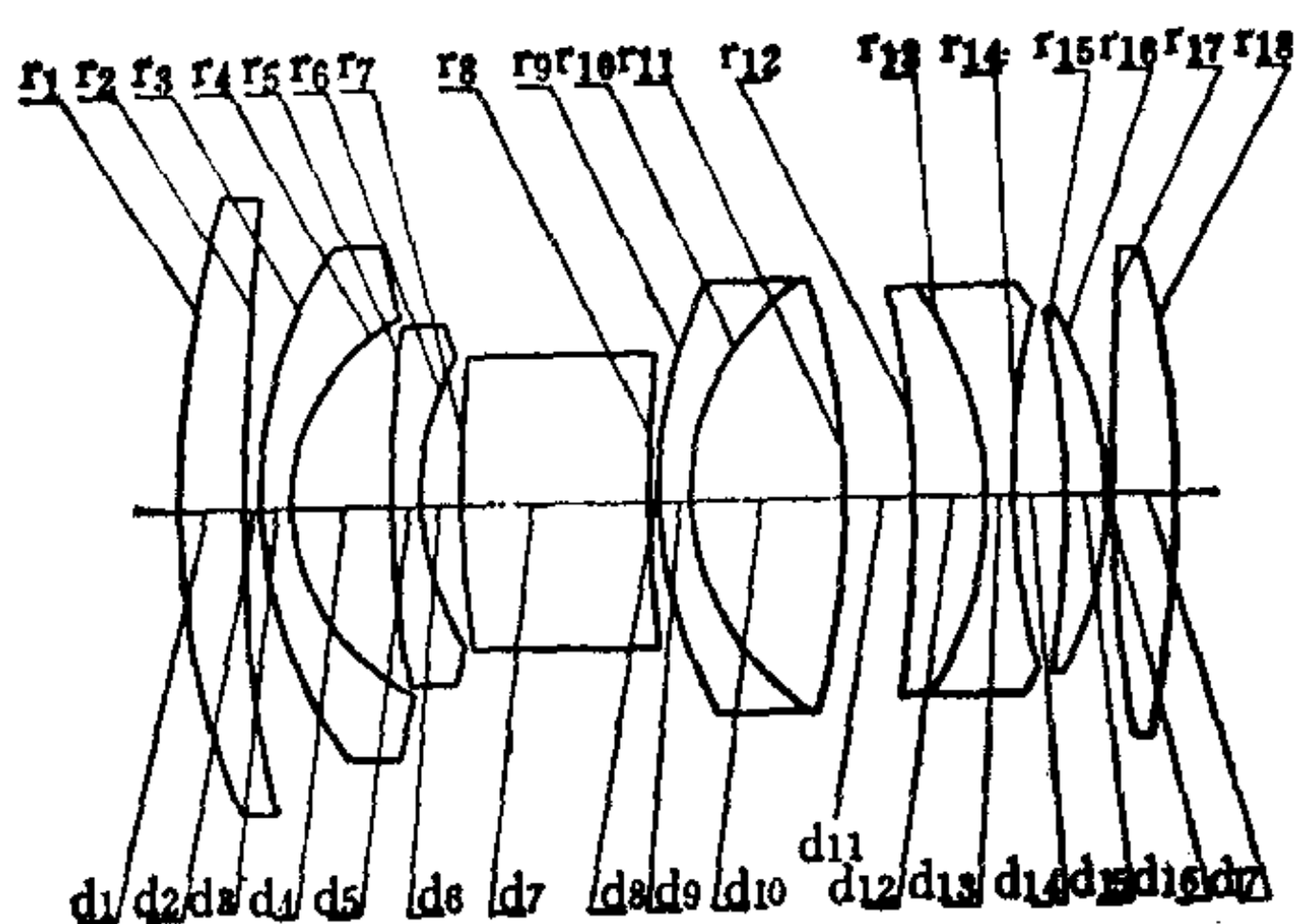

序号	r	d	n	v	序号	r	d	n	v
1	2.3797	0.1858	1.72000	43.7	10	0.6760	0.3864	1.59340	34.8
2	6.0515	0.0060			11	-2.0937	0.1644*		
3	1.0602	0.0697	1.72000	50.3	12	-18.7474	0.1760	1.75700	47.9
4	0.5380	0.2313			13	-0.9208	0.0697	1.80518	25.4
5	2.5597	0.0650	1.75700	47.9	14	2.0162	0.1092		
6	0.6420	0.0975			15	-3.0293	0.1301	1.69680	55.6
7	3.7555	0.4700	1.61659	36.6	16	-0.9252	0.0046		
8	80.9316	0.0046			17	4.4424	0.1393	1.69680	55.6
9	1.1565	0.0650	1.67000	57.3	18	-2.2486			

0.1644* = 0.0822 + 0.0822

	ΣS_1	ΣS_2	ΣS_3	ΣS_4	ΣS_5	HI	QP(1 ω)
	-0.00349	0.00253	-0.00087	-0.00390	-0.01754	1	-1.9%
h 或 ω %	LA'	$\Delta H'$	x'_t	x'_s	$x'_t - x'_s$	K'_{T1}	$K'_{T0.7}$
100	0.00249	-0.01943	0.00460	0.01006	-0.00546	-0.002499	-0.001248
70	-0.00728	-0.01702	-0.00655	-0.01192	0.00537	-0.001895	-0.000489

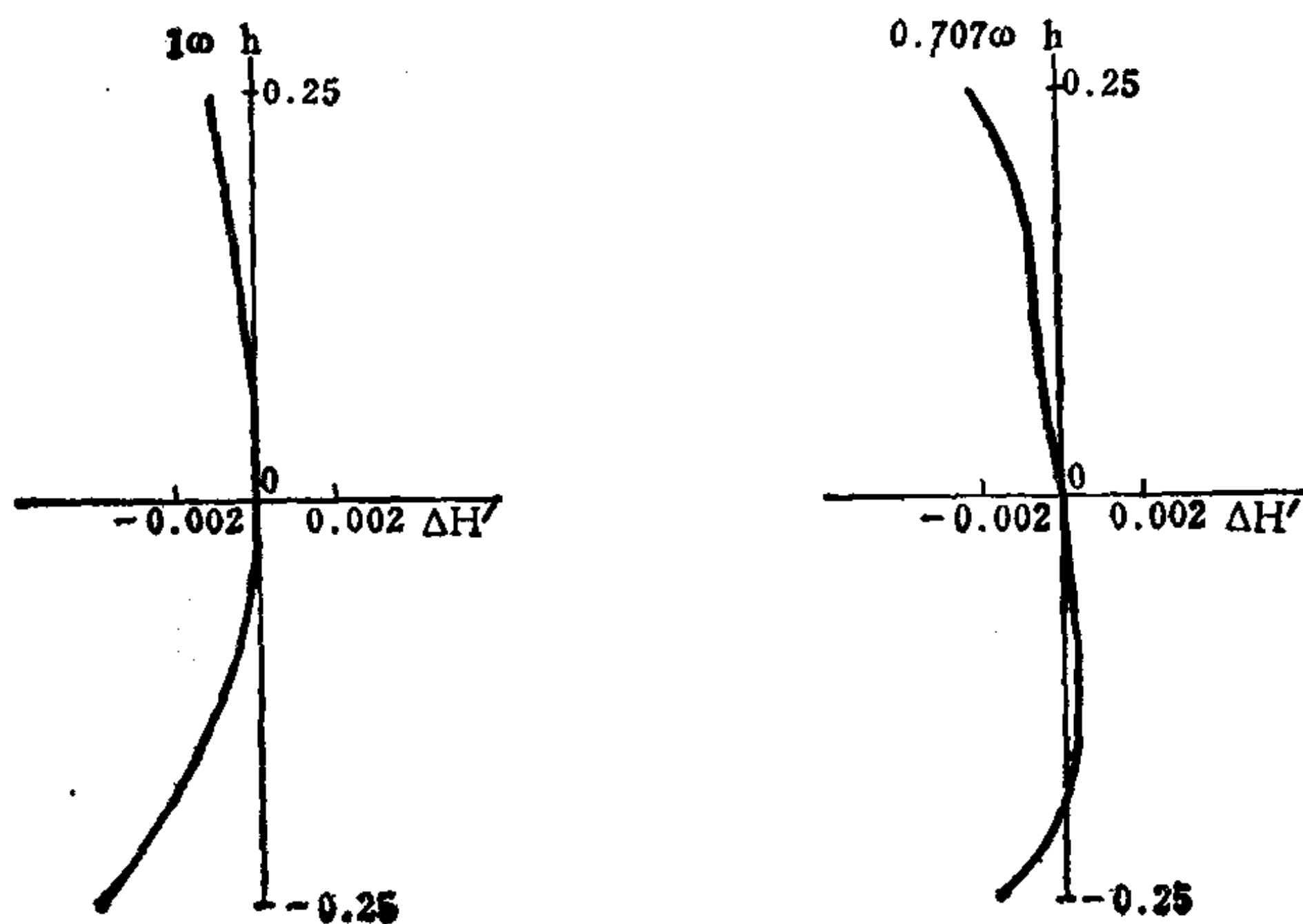
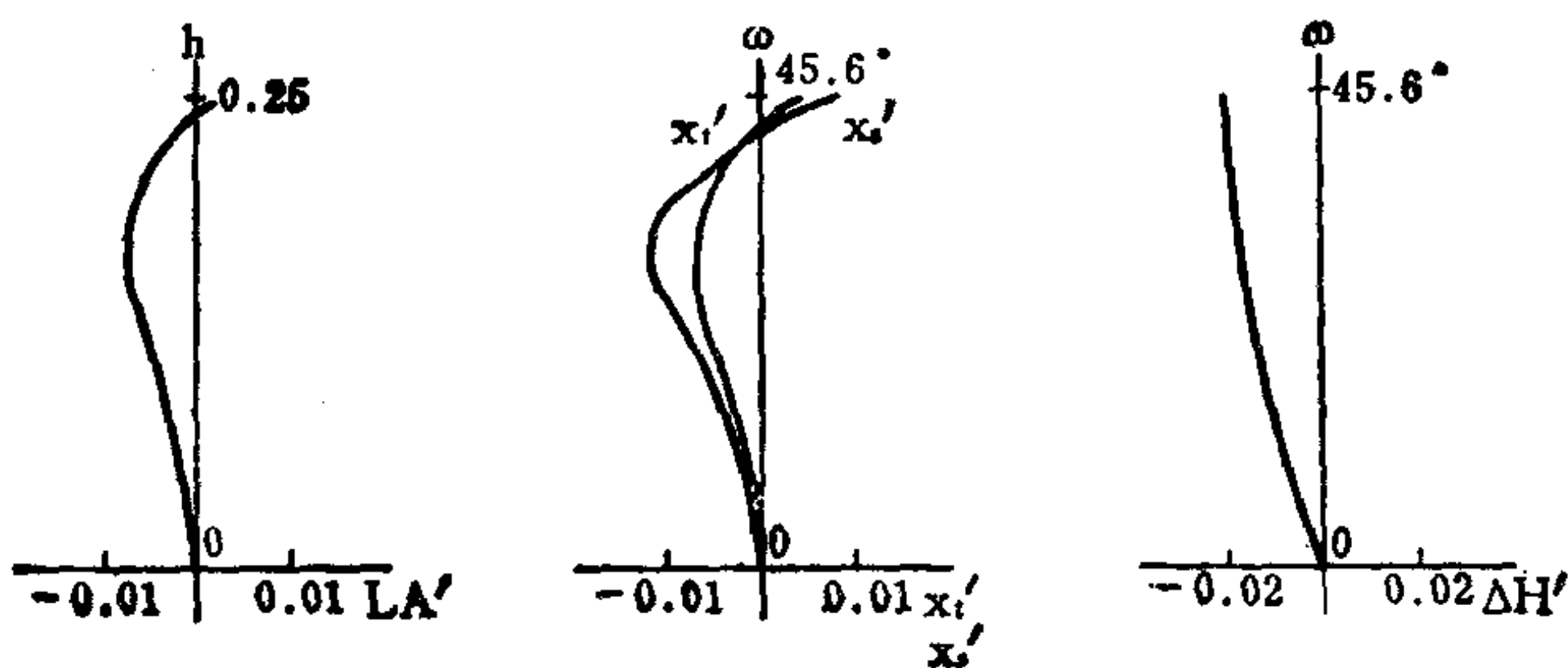

编号: 07-02-059

超广角大孔径照相物镜

E. F. L = 1

B. F. L = 1.7449

FN₀ = 2

F. A. = ±45.6°

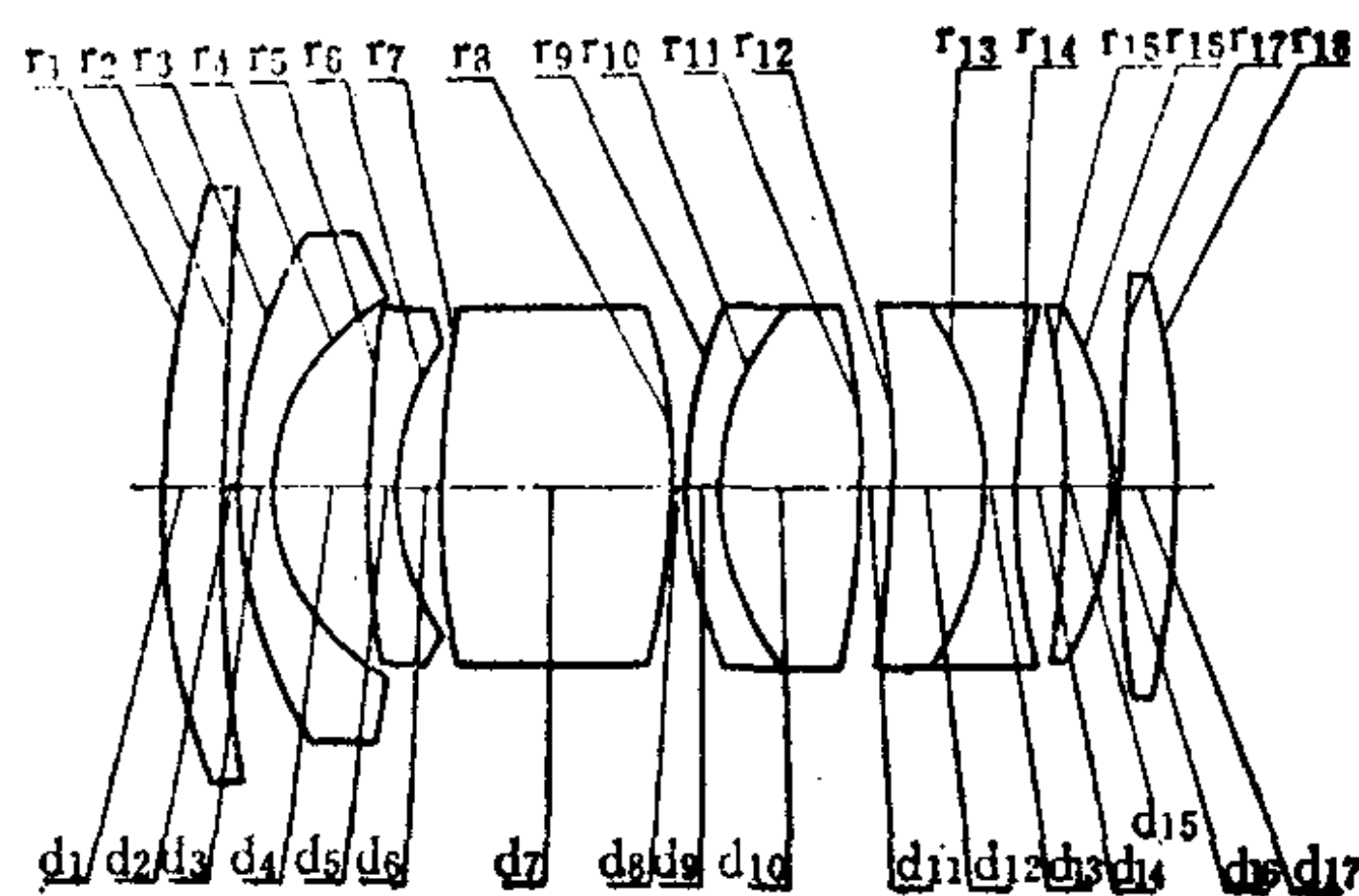

序号	r	d	n	v	序号	r	d	n	v
1	2.2985	0.1861	1.72000	43.7	10	0.6664	0.3582	1.59270	35.5
2	6.1755	0.0060			11	-2.2077	0.0791*		
3	1.2449	0.0698	1.72000	50.3	12	-19.9488	0.2256	1.76200	40.2
4	0.5505	0.2117			13	-0.8204	0.0698	1.80518	25.4
5	2.7180	0.0698	1.75700	47.9	14	1.5855	0.1037		
6	0.6417	0.0921			15	-4.4064	0.1303	1.61800	63.4
7	3.1449	0.5624	1.61659	36.6	16	-0.9207	0.0070		
8	-6.8093	0.0047			17	7.4043	0.1396	1.69680	55.6
9	1.1094	0.0698	1.67000	57.3	18	-1.8352			

0.0791* = 0.0400 + 0.0391

	ΣS ₁	ΣS ₂	ΣS ₃	ΣS ₄	ΣS ₅	HI	QP (1ω)
	-0.00387	0.00206	-0.00002	-0.00411	-0.01912	1	-2.2%
h 或 ω %	LA'	ΔH'	x _t '	x _s '	x _t ' - x _s '	K _{T1}	K _{T0.7}
100	0.00055	-0.02281	-0.00525	0.00325	-0.00850	-0.000619	-0.000349
70	-0.00837	-0.01792	-0.00559	-0.01303	0.00744	-0.001210	-0.000107

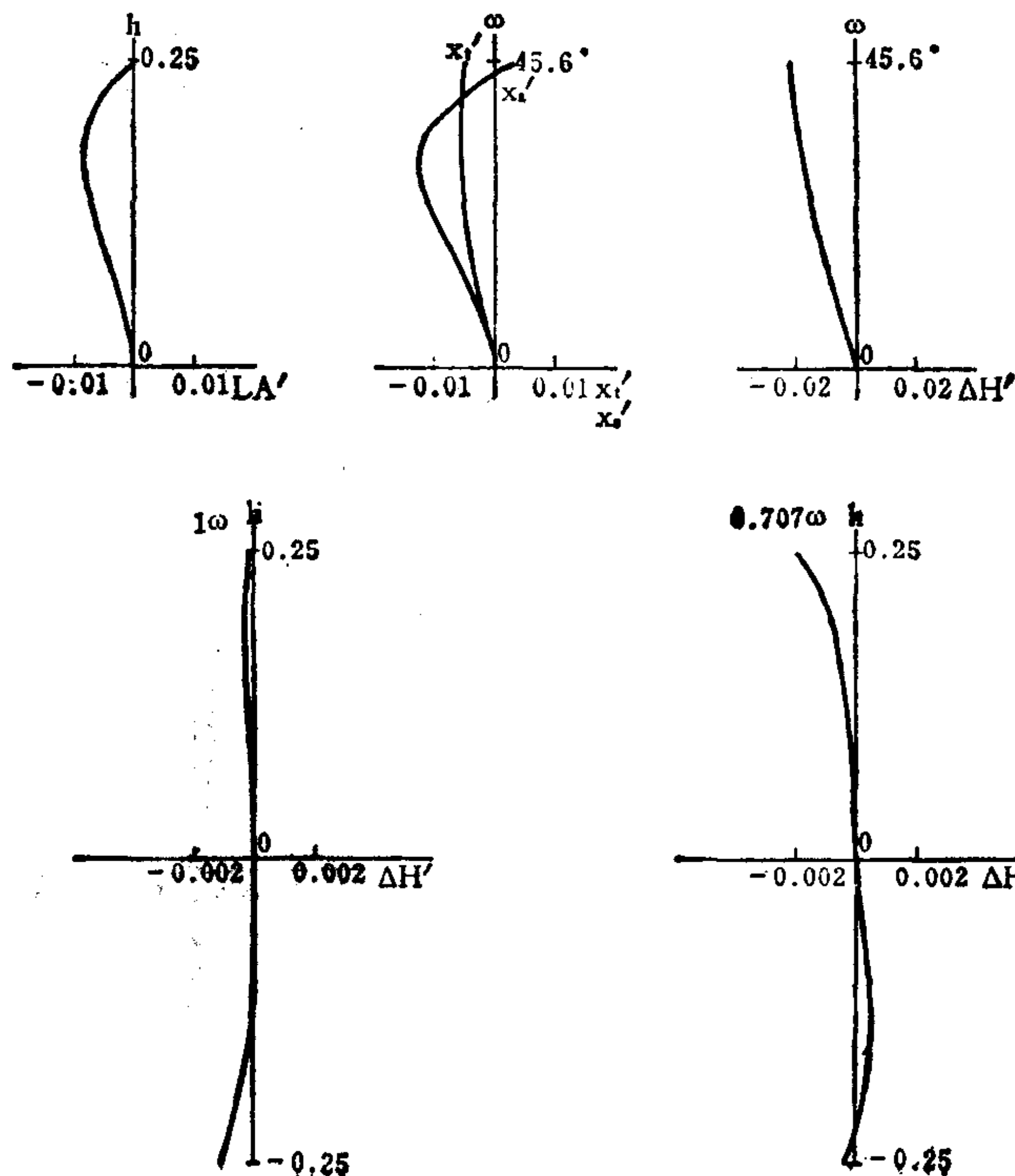

编号: 07-02-060

超广角大孔径照相物镜

E. F. L = 0.992

B. F. L = 1.7498

FNo. = 2

F. A. = ± 45.6°

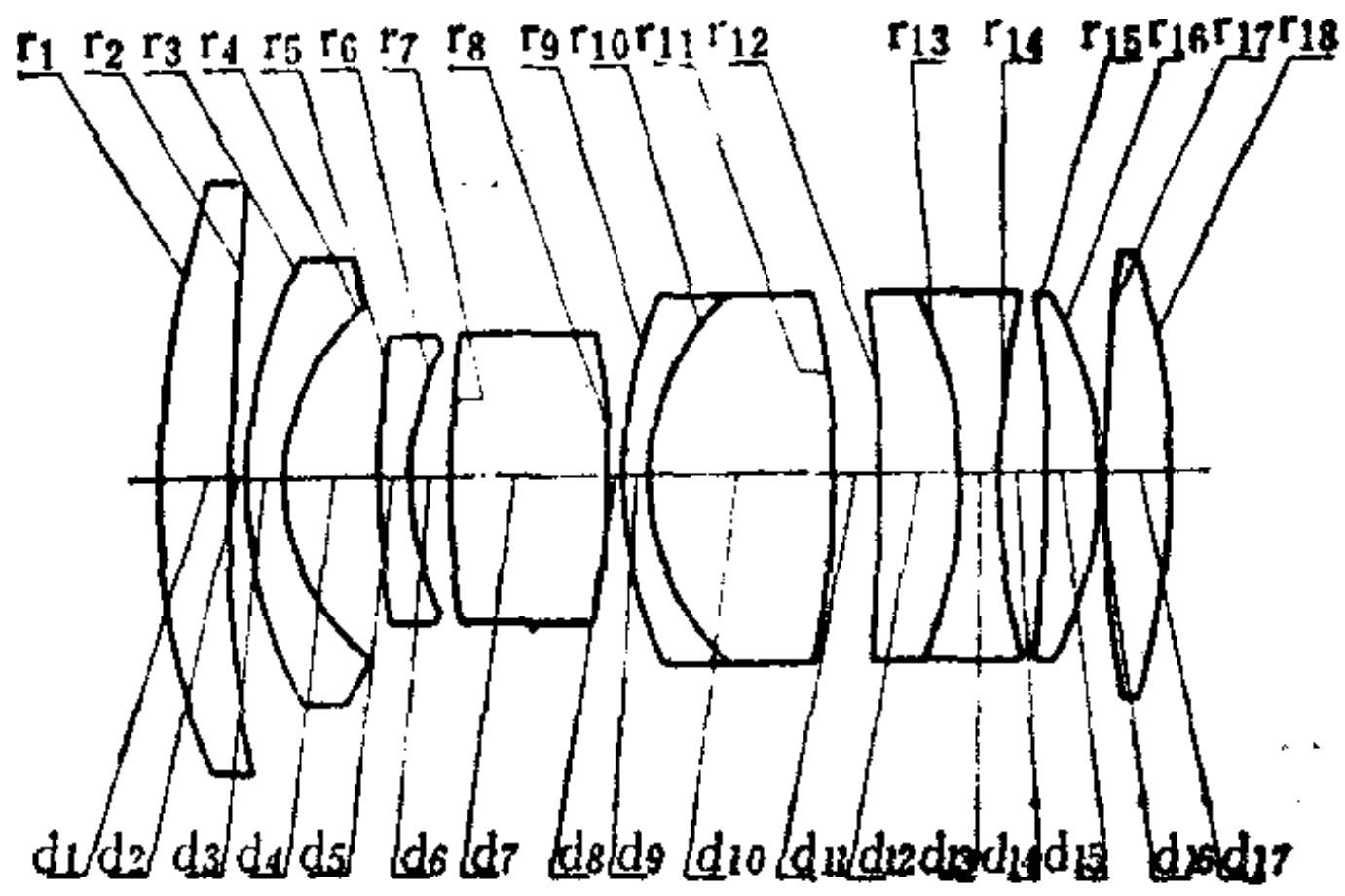

序号	r	d	n	v	序号	r	d	n	v
1	2.1566	0.1859	1.72000	43.7	10	0.6404	0.4359	1.59340	34.8
2	5.5649	0.0060			11	-1.7832	0.1041*		
3	1.1925	0.0697	1.72000	50.3	12	-12.1151	0.2012	1.75700	47.9
4	0.5291	0.2310			13	-0.8601	0.0697	1.80518	25.4
5	2.6413	0.0651	1.75700	47.9	14	1.8440	0.1204		
6	0.6309	0.0976			15	-3.1194	0.1301	1.69680	55.6
7	3.9450	0.3837	1.61659	36.6	16	-0.9239	0.0093		
8	-11.2560	0.0046			17	8.9834	0.1394	1.69680	55.6
9	1.0887	0.0651	1.67000	57.3	18	-1.7999			

0.1041* = 0.0521 + 0.0520

	ΣS_1	ΣS_2	ΣS_3	ΣS_4	ΣS_5	HI	QP(1 ω)
	-0.005291	0.002613	0.000101	-0.003621	-0.020032	1	-2.3%
h 或 ω %	LA'	$\Delta H'$	x'_i	x'_o	$x'_i - x'_o$	K'_{T1}	$K'_{T0.7}$
100	-0.00680	-0.02332	0.01298	0.01516	-0.00218	-0.0020707	-0.001314
70	-0.01253	-0.01795	0.00174	-0.00812	0.00986	-0.003646	-0.001075

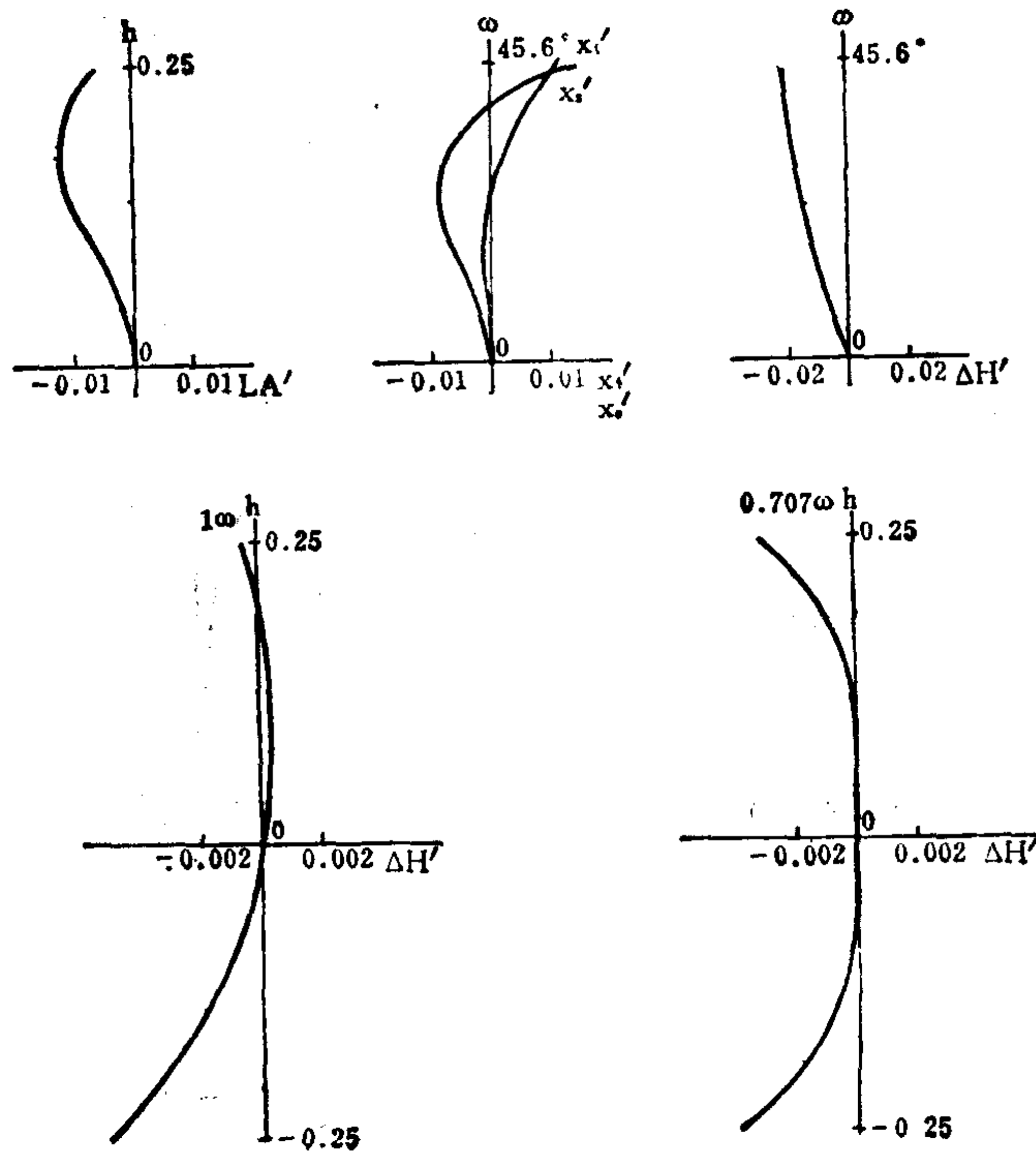

编号: 07-02-061

超广角大孔径照相物镜

E. F. L = 1

B. F. L = 1.7555

FNo. = 2

F. A. = ± 45.6°

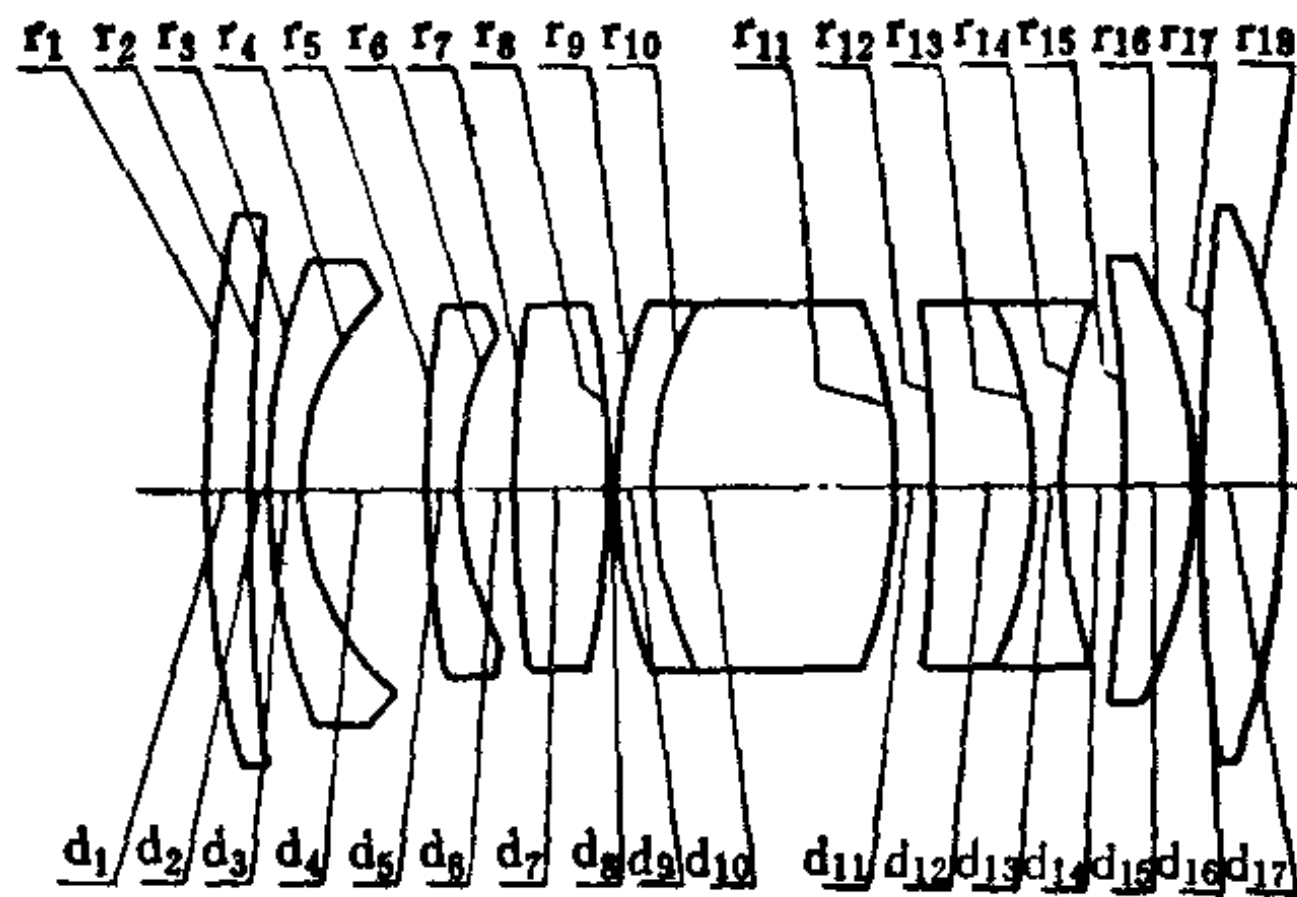

序号	r	d	n	v	序号	r	d	n	v
1	2.1413	0.1860	1.72000	43.7	10	0.6588	0.4655	1.59270	35.5
2	5.5682	0.0060			11	-1.6073	0.1042*		
3	1.2587	0.0698	1.72000	50.3	12	-6.3013	0.1753	1.75700	47.9
4	0.5311	0.2320			13	-0.8649	0.0698	1.80518	25.4
5	2.4881	0.0651	1.75700	47.9	14	1.8400	0.1046		
6	0.6393	0.0977			15	-3.0518	0.1395	1.69680	55.6
7	4.2587	0.3636	1.61659	36.6	16	-0.9570	0.0093		
8	-7.5941	0.0047			17	11.4357	0.1395	1.69680	55.6
9	1.0986	0.0651	1.67000	57.3	18	-1.5778			

$0.1042^* = 0.0521 + 0.0521$

	ΣS_1	ΣS_2	ΣS_3	ΣS_4	ΣS_5	HI	QP(1 ω)
	-0.00467	0.00299	-0.00088	-0.00378	-0.01882	1	-2.1%
h 或 ω %	LA'	$\Delta H'$	x'_i	x'_o	$x'_i - x'_o$	K'_{T1}	$K'_{T0.7}$
100	0.00429	-0.02192	-0.00693	0.00883	-0.01576	-0.002397	-0.001160
70	-0.00834	-0.01805	-0.00544	-0.01129	0.00585	-0.002281	-0.000381

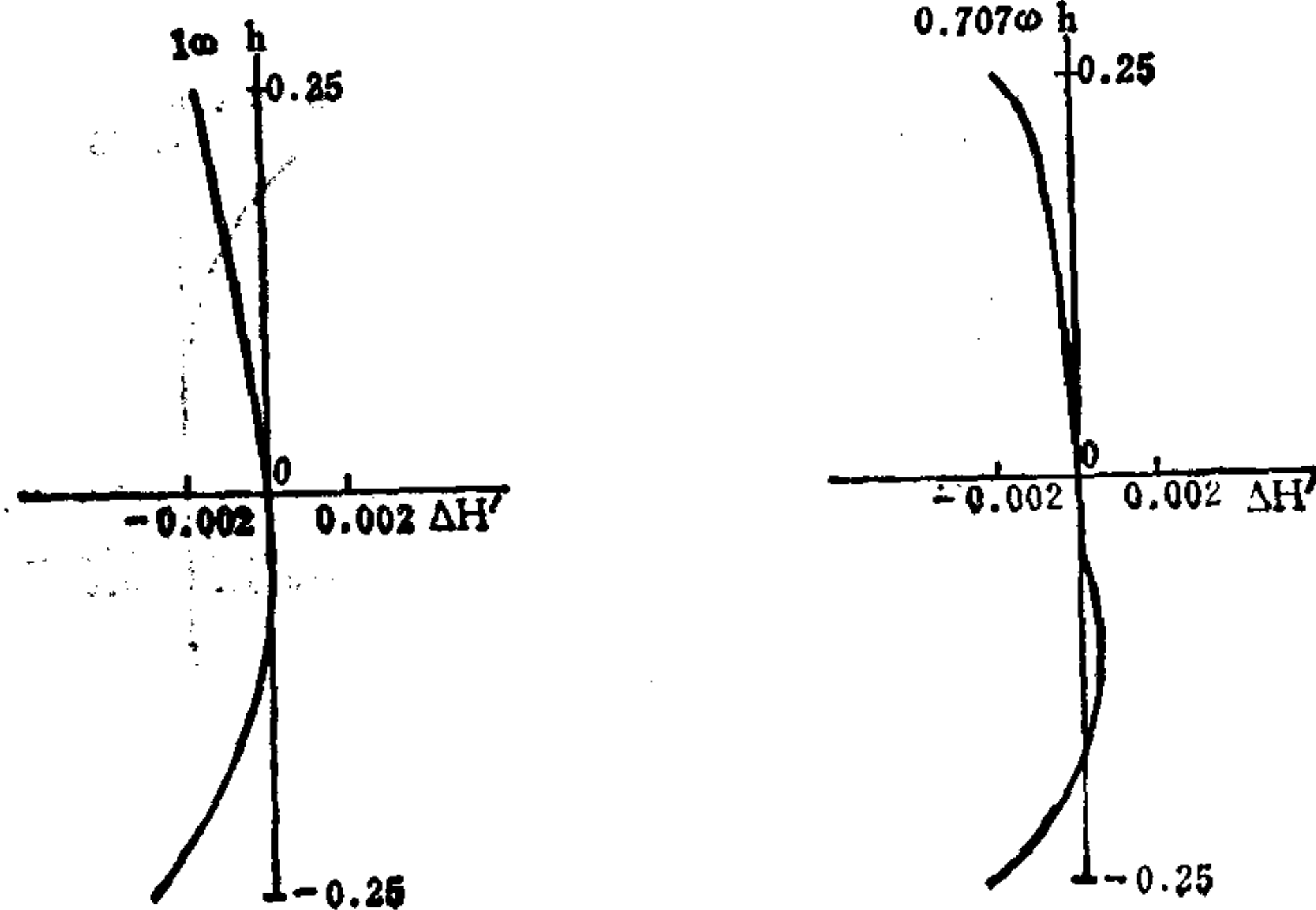
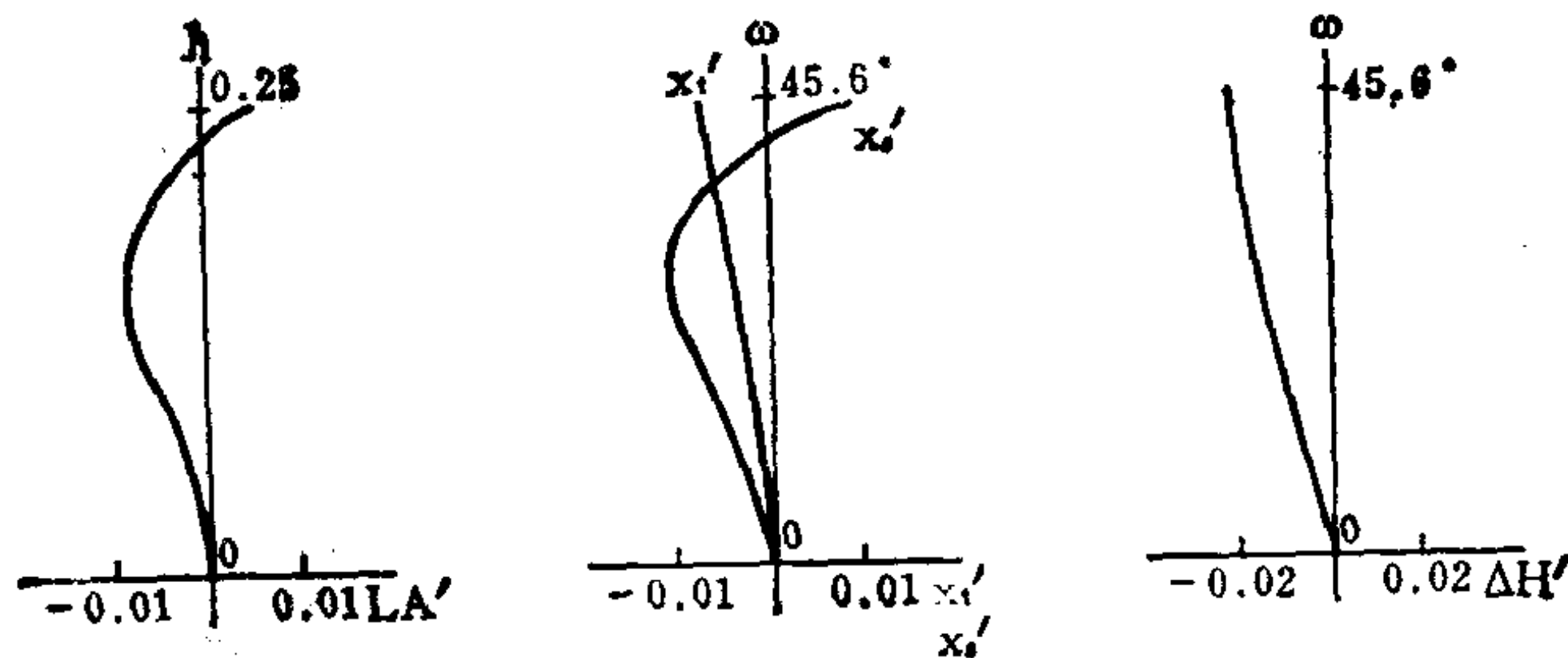

编号: 07-02-062

反远距型超广角物镜

E. F. L = 13.01

B. F. L = 37.28

FNo. = 7.9

F. A. = ±40°**

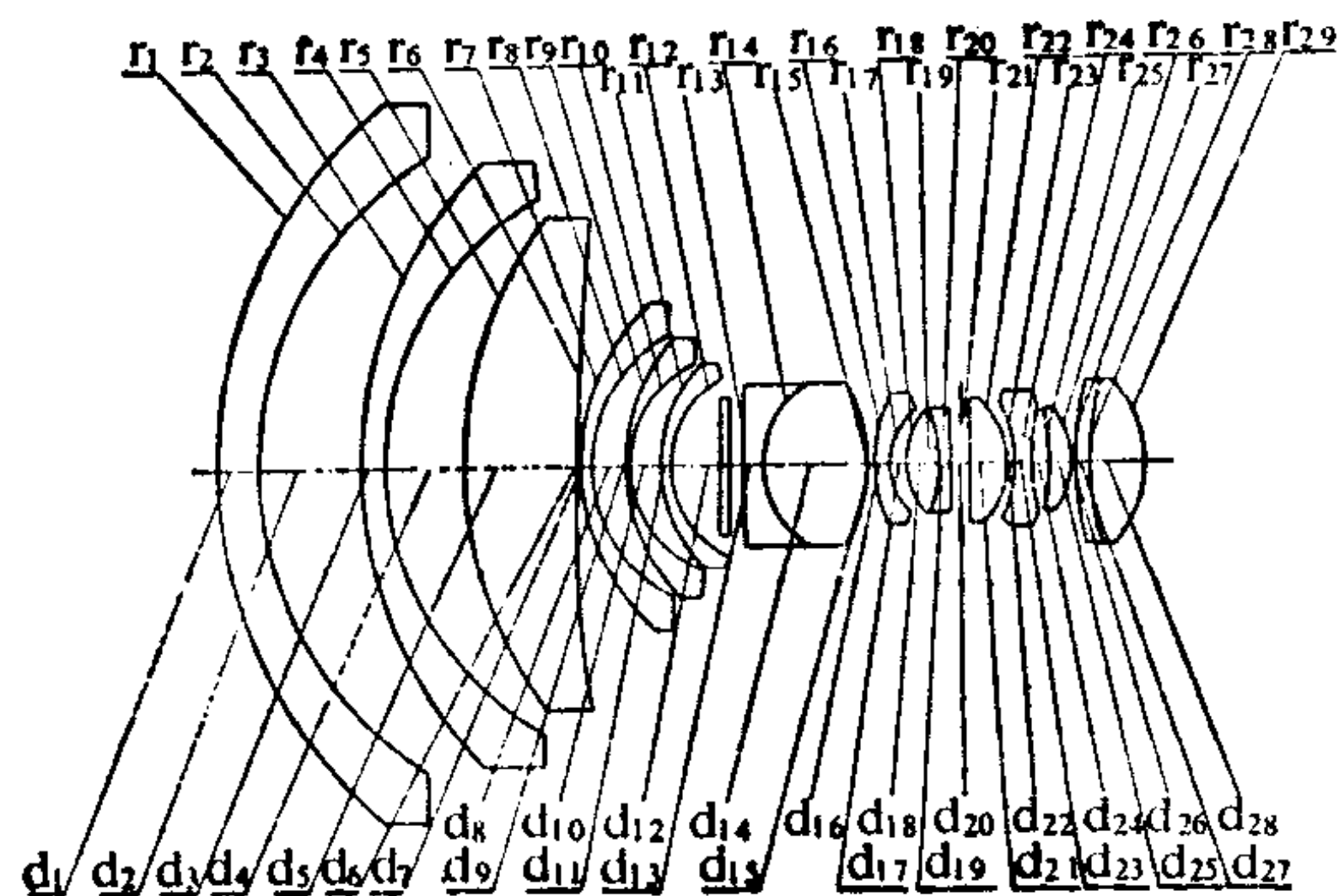

序号	r	d	n	va	序号	r	d	n	va
1	57.200	3.90	1.77279	49.5	15	-15.800	0.10		
2	43.000	11.90			16	17.000	0.80	1.69680	55.6
3	51.000	3.00	1.73350	51.0	17	7.450	1.70		
4	37.500	9.30			18	11.900	2.80	1.59507	35.6
5	48.200	13.50	1.73200	53.7	19	-9.000	0.90	1.60311	60.7
6	190.000	0.10			20	∞	1.60*		
7	28.500	1.20	1.73350	51.0	21	∞	4.10	1.59507	35.6
8	17.600	3.30			22	-10.500	0.60		
9	22.500	1.00	1.73200	53.7	23	-13.100	1.50	1.86074	23.1
10	13.200	3.00			24	35.400	0.65		
11	17.600	1.00	1.73200	53.7	25	-41.000	2.20	1.44628	67.2
12	12.000	8.20			26	-9.600	0.10		
	∞				27	900.000	0.80	1.86630	37.9
	∞				28	30.700	5.70	1.48749	70.0
13	350.000	3.00	1.83739	43.5	29	-14.901			
14	12.080	12.30	1.54072	47.2					

1.60* = 0.80 + 0.80

	ΣS ₁	ΣS ₂	ΣS ₃	ΣS ₄	ΣS ₅	HI	QP(1ω)
	-0.00315	0.00648	-0.01161	-0.00340	-0.00983	1	-2.6%
h 或 ω %	LA'	ΔH'	x _t '	x _s '	x _t ' - x _s '	K _{T1}	K _{T0.7}
100	-0.349	-0.2856	0.00015	-0.30681	0.30696	-0.002889	-0.001628
70	-0.186	-0.1155	0.06417	-0.14354	0.20771	-0.002776	-0.002028

注: 1. 以上象差值计算时, 未考虑滤色片。

2. 滤色片的基底玻璃是K9, d = 1.2。

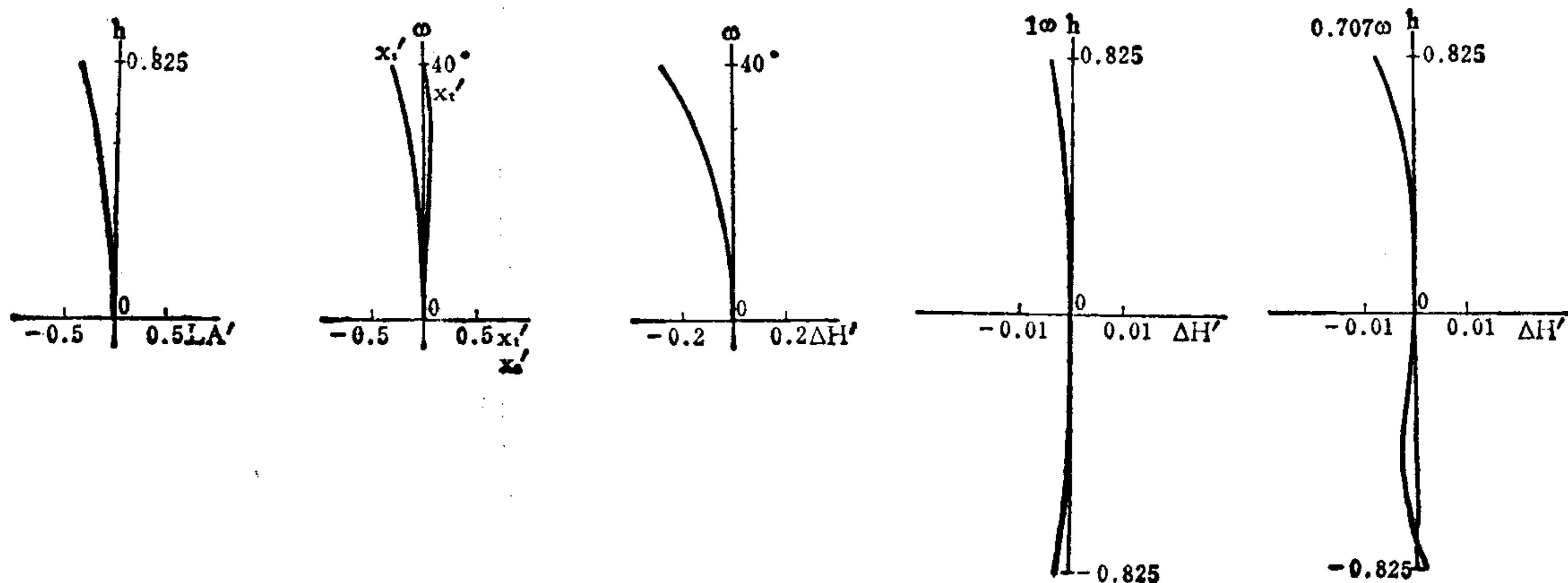

编号: 07-02-063

广角照相物镜

E. F. L = 100

B. F. L = 156.64

FNo. = 2.8

F. A. = ±42°

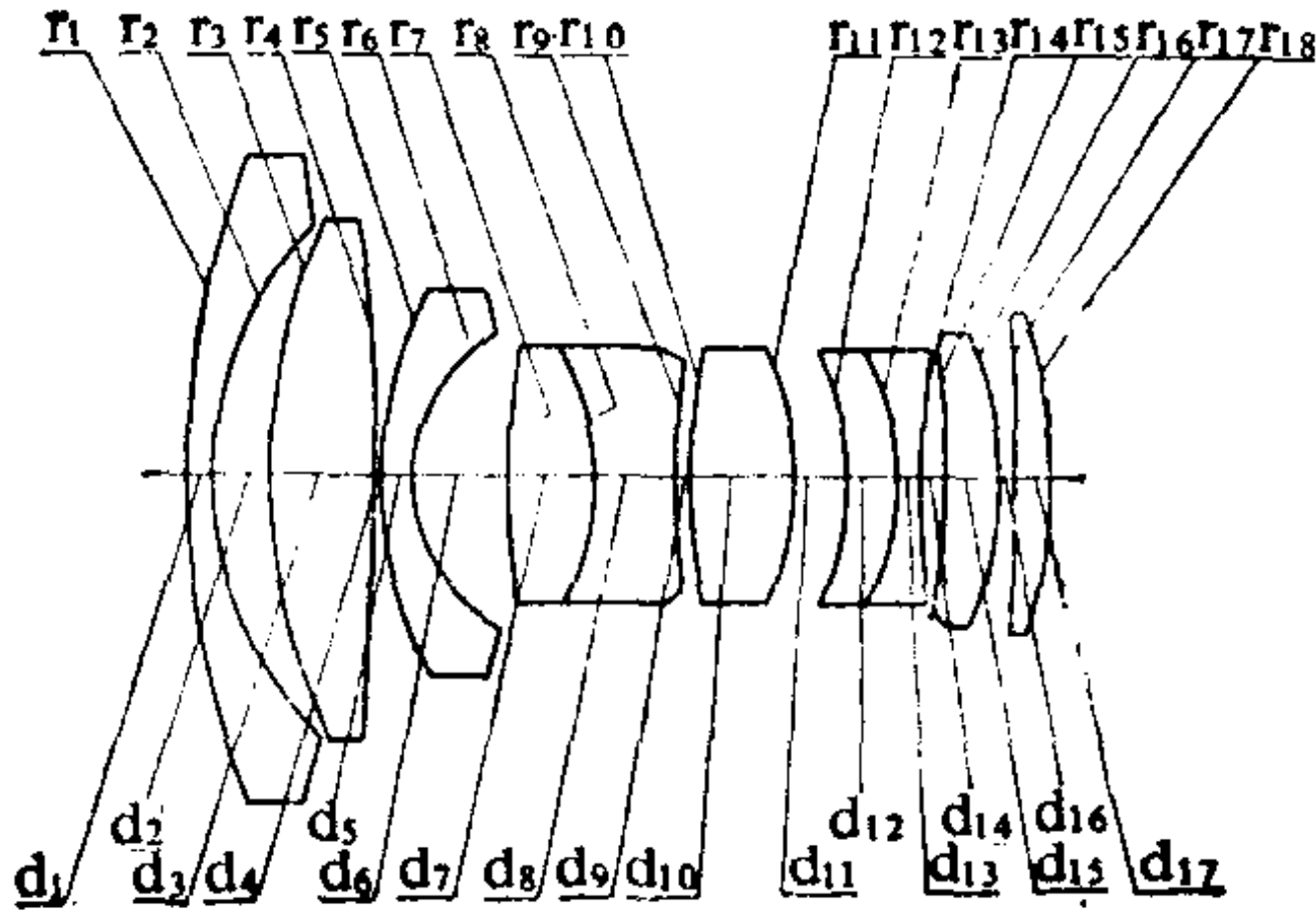

序号	r	d	n	v	序号	r	d	n	v
1	195.05	7.5	1.6204	30.3	10	158.20	22.50	1.6700	57.3
2	85.38	14.58			11	-79.50	12.08*		
3	157.55	22.92	1.6510	56.2	12	-75.56	12.50	1.7570	47.9
4	-2594.05	0.83			13	-50.29	6.25	1.6989	30.1
5	99.68	6.25	1.5891	61.1	14	218.85	3.79		
6	38.99	22.50			15	-215.93	11.67	1.6968	55.6
7	368.12	18.75	1.6129	37.0	16	-72.68	0.83		
8	-59.99	19.58	1.7130	53.9	17	-2105.58	10.83	1.6968	55.6
9	475.55	2.50			18	-116.19			

12.08* = 6.00 + 6.08

	ΣS_1	ΣS_2	ΣS_3	ΣS_4	ΣS_5	HI	QP(1 ω)
	-0.1737	0.0800	0.0146	-0.1960	-1.0432	90	-1.9%
h 或 ω %	LA'	$\Delta H'$	x'_t	x'_s	$x'_t - x'_s$	K'_{T1}	$K'_{T0.7}$
100	-0.126	-1.763	-0.638	0.054	-0.692	-0.12119	-0.02404
70	-0.844	-1.220	-0.731	-1.089	0.358	-0.28754	-0.05036

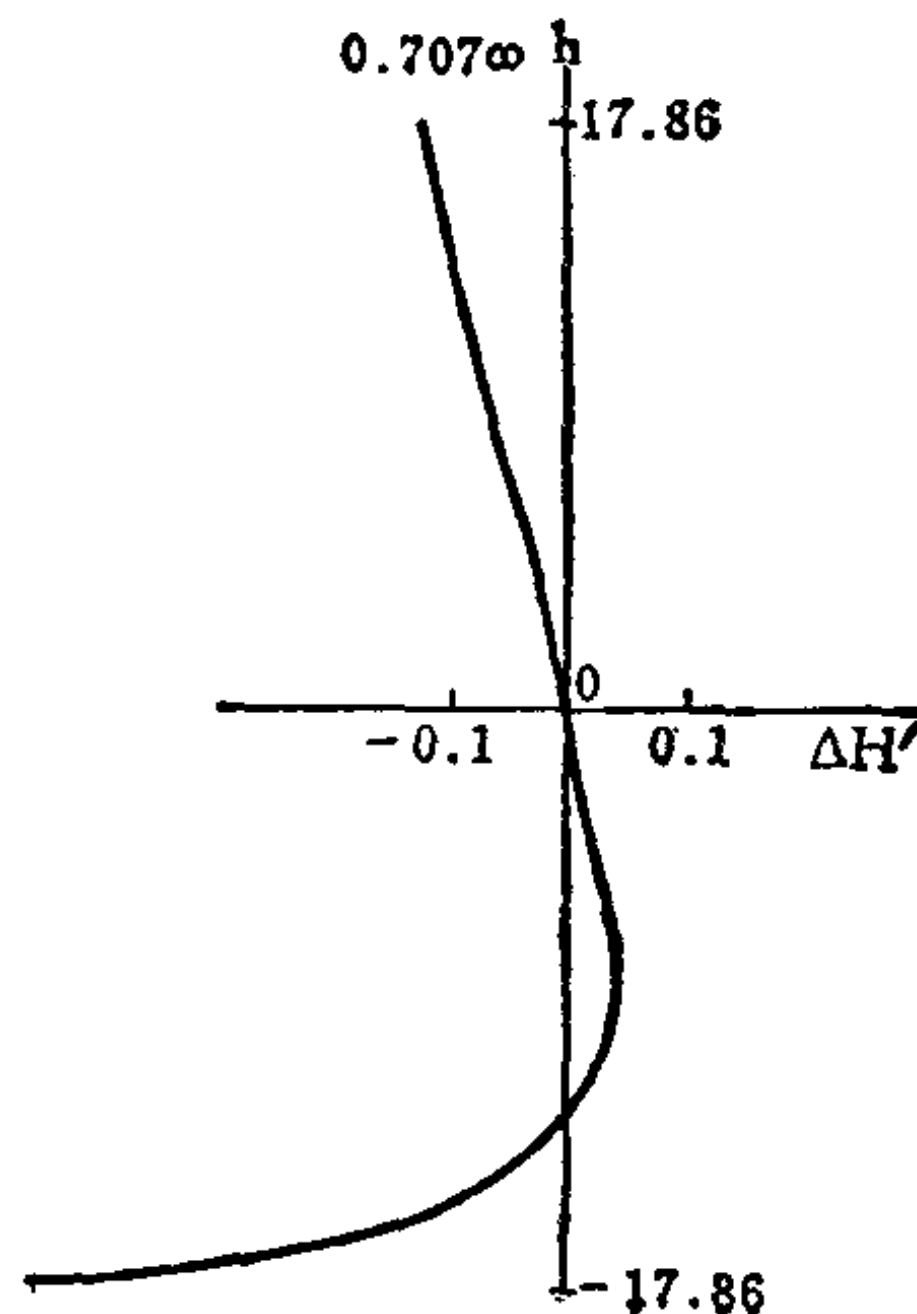
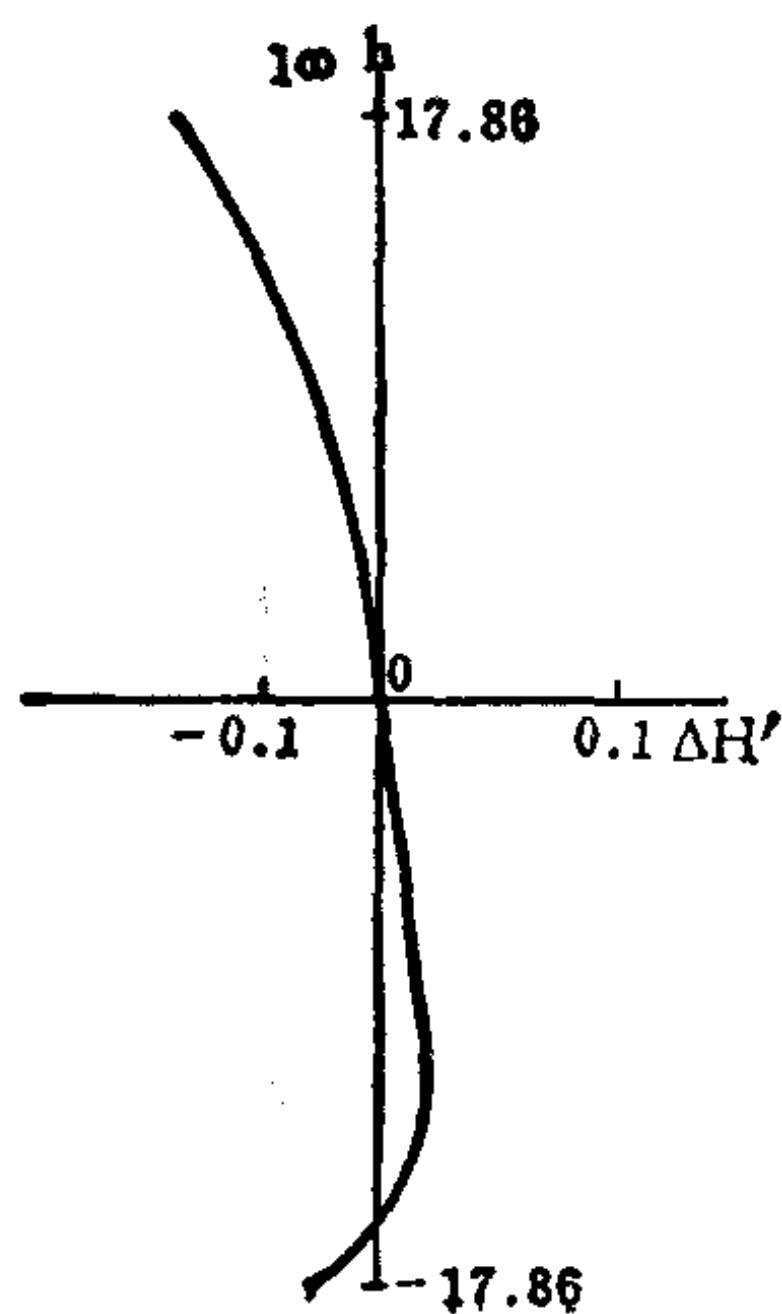
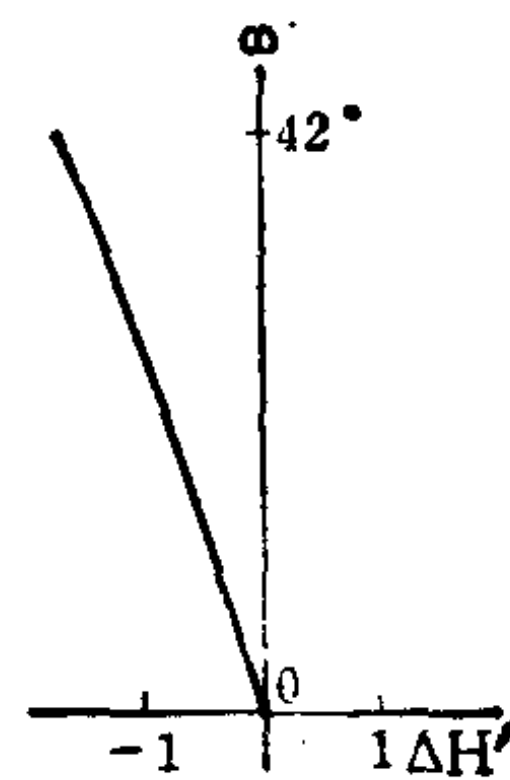
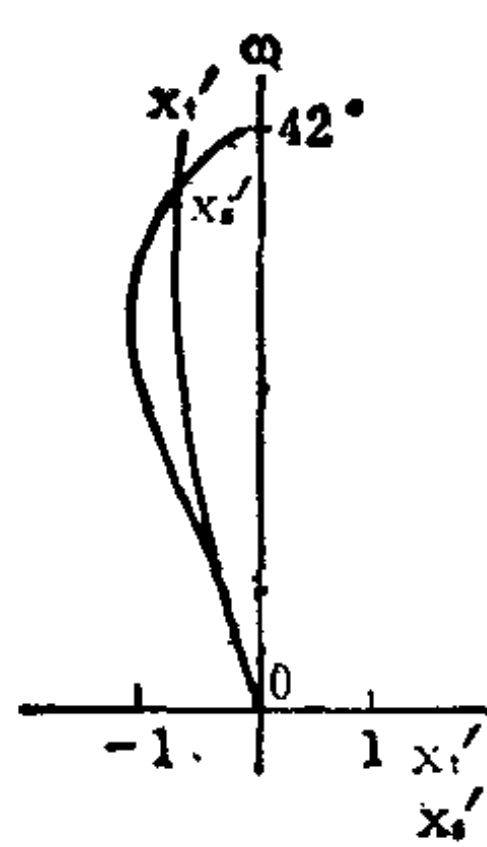
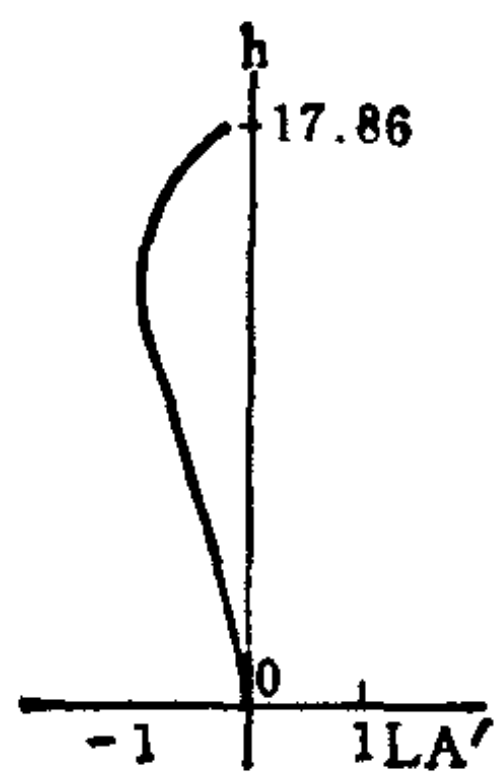

编号: 07-02-064

广角照相物镜

E. F. L = 99.4

B. F. L = 154.3

FNo. = 2.78

F. A. = ± 42°

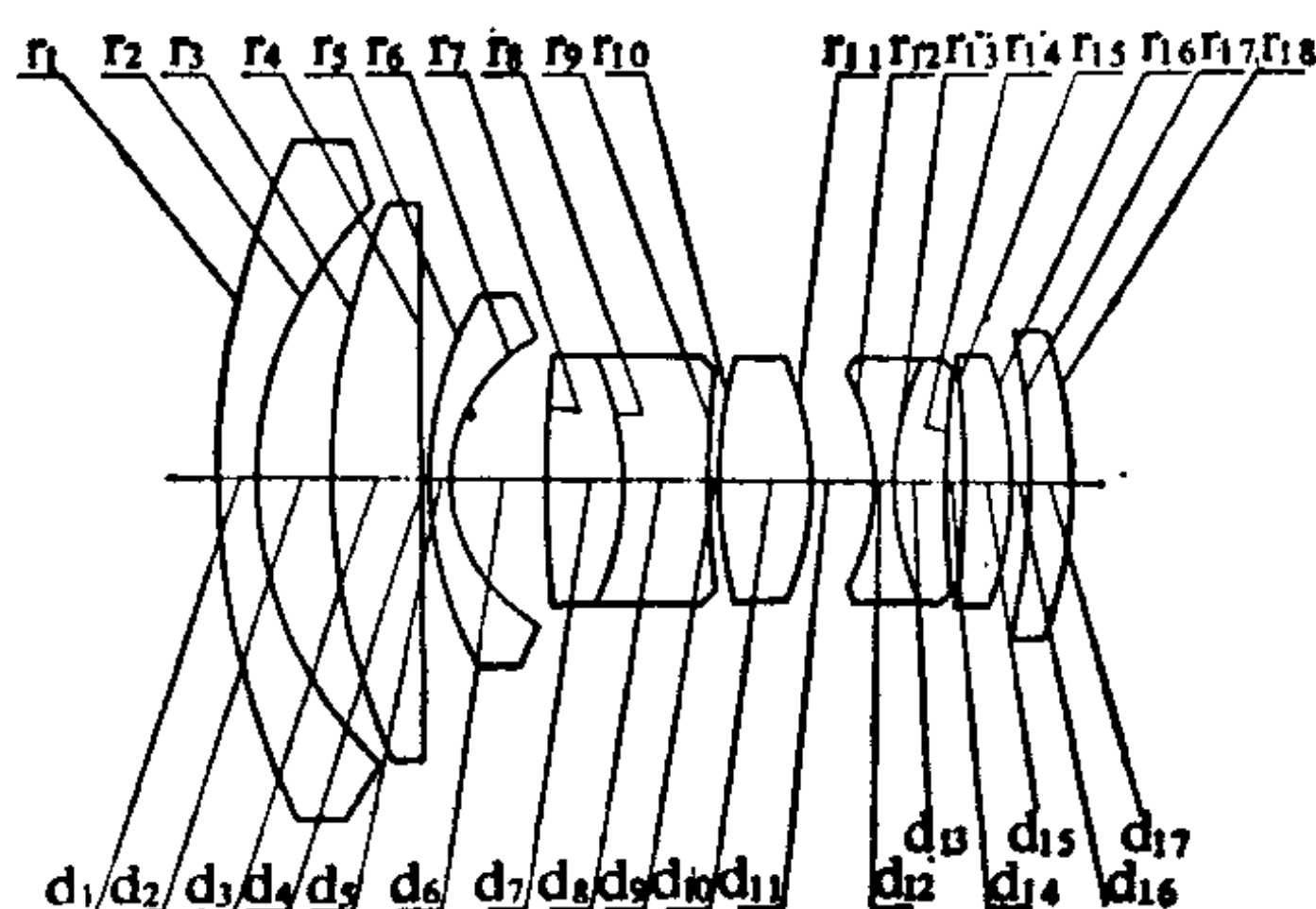

序号	r	d	n	v	序号	r	d	n	v
1	203.53	7.50	1.69350	53.34	10	207.57	22.50	1.67000	57.33
2	92.35	15.83			11	-73.95	12.08*		
3	152.42	22.50	1.71700	47.94	12	-73.27	6.25	1.68893	31.08
4	∞	1.23			13	68.68	12.50	1.74320	49.37
5	102.17	6.25	1.58913	61.11	14	216.39	3.79		
6	38.62	22.92			15	-241.78	11.25	1.69680	55.62
7	253.44	18.75	1.61923	37.00	16	-73.40	0.83		
8	-58.34	20.00	1.71300	53.98	17	-784.30	10.42	1.69680	55.62
9	332.03	2.08			18	-103.79			

12.08* = 6.00 + 6.08

	ΣS_1	ΣS_2	ΣS_3	ΣS_4	ΣS_5	HI	QP(1 ω)
	-0.1975	0.0871	0.0069	-0.2057	-1.0063	89.5	-1.5%
h 或 ω %	LA'	$\Delta H'$	x'_i	x'_s	$x'_i - x'_s$	K'_{T1}	$K'_{T0.7}$
100	-0.022	-1.357	-3.531	-0.542	-2.989	0.1527	0.1052
70	-0.939	-1.151	-1.181	-1.247	0.066	-0.3296	-0.0472

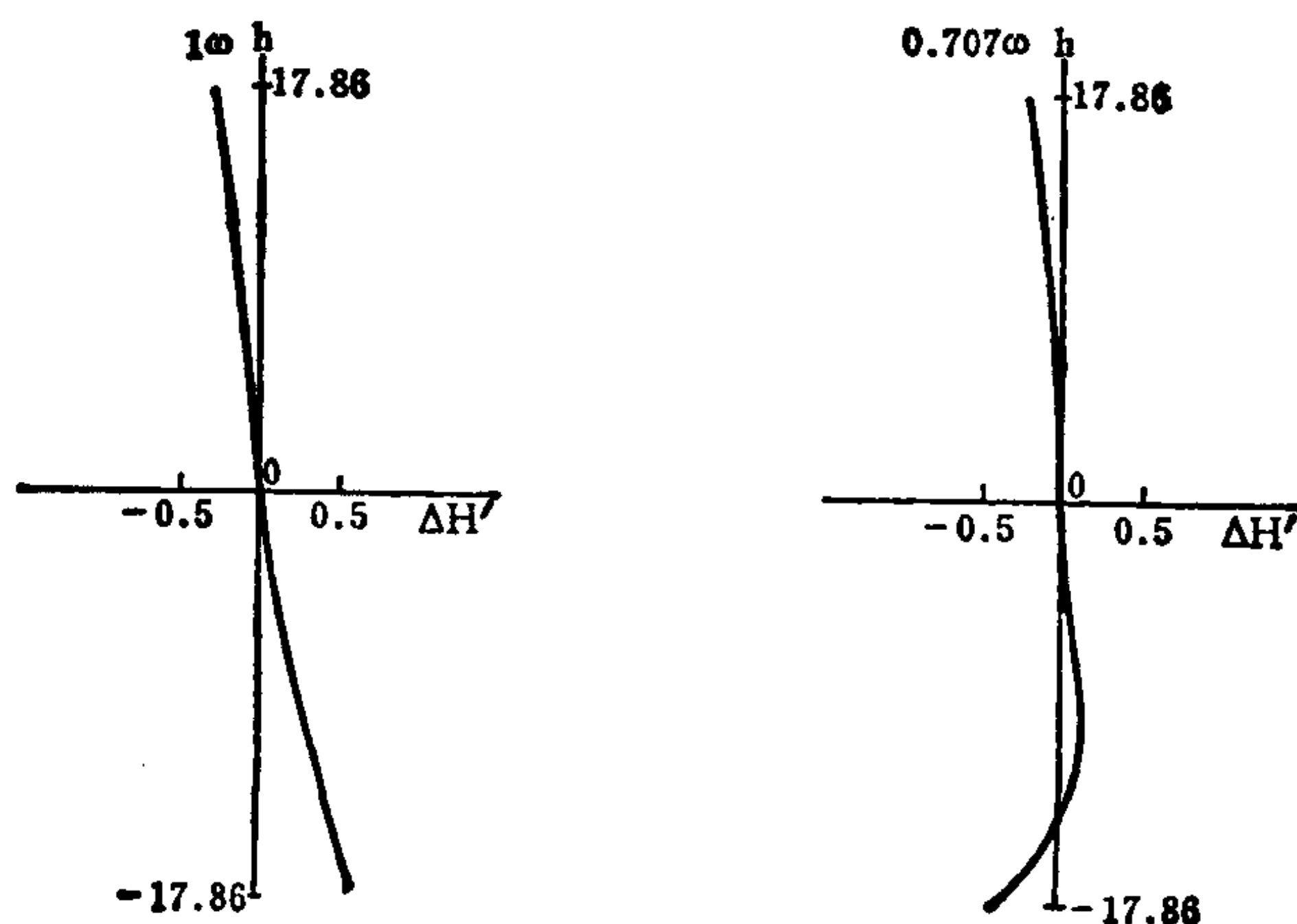
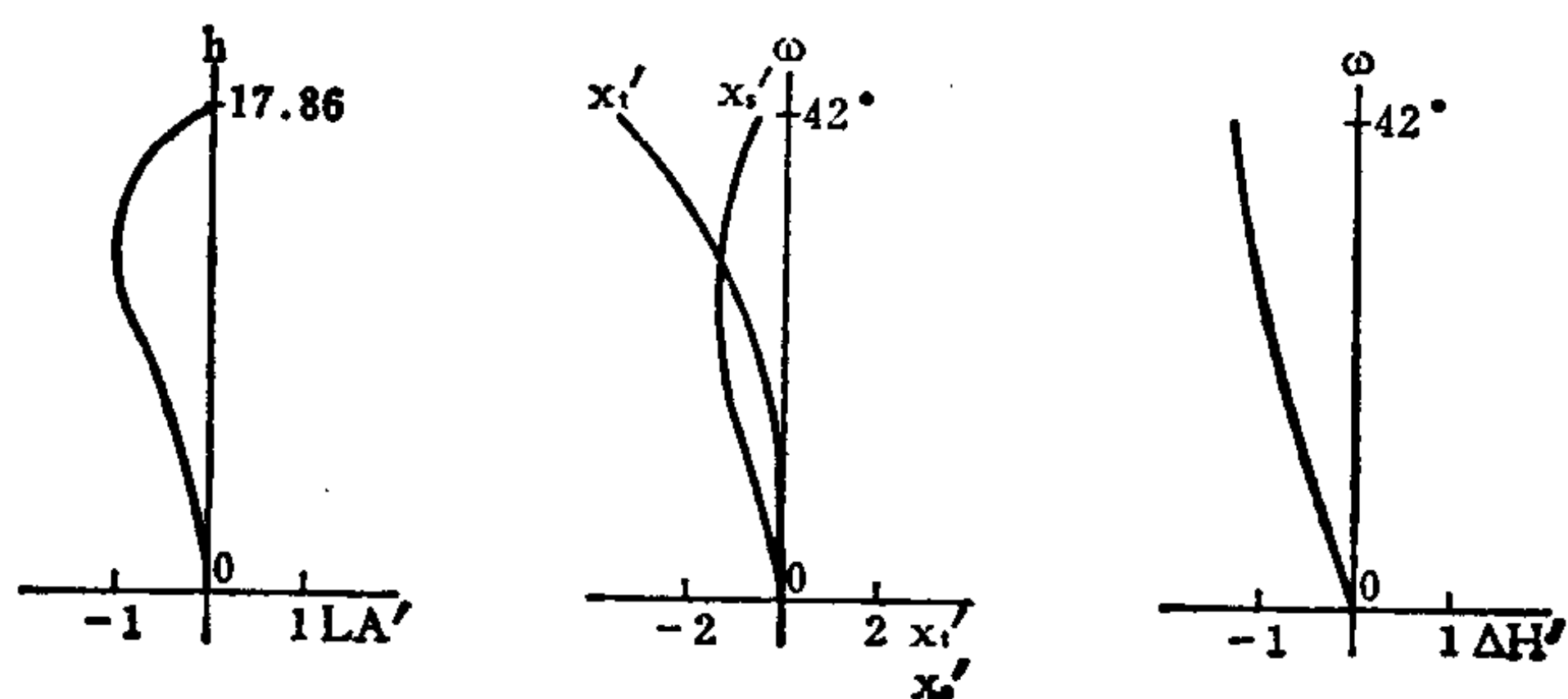

编号: 07-02-065

鱼 眼 物 镜

E. F. L = 1

B. F. L = 2.2916

FNo. = 3.5

F. A. = $\pm 90^\circ$

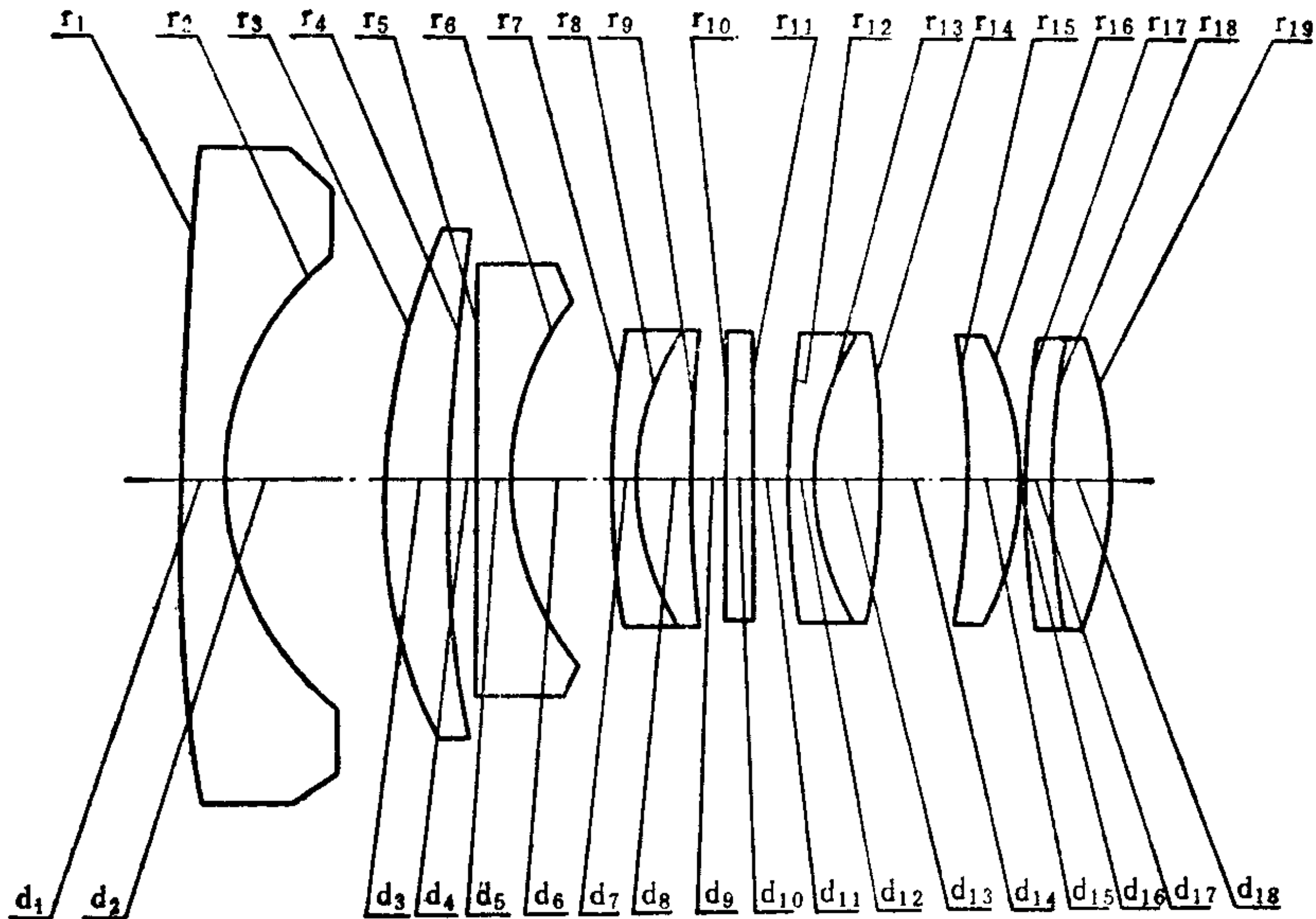

序号	r	d	n	v
1	5.5184	0.1237	1.58913	61.10
2	0.7370	0.4157		
3	1.6084	0.1856	1.7859	44.24
4	3.4234	0.0928		
5	-86.6068	0.0742	1.58913	61.10
6	0.6965	0.2598		
7	1.8556	0.0619	1.69680	55.60
8	0.6771	0.1534	1.69895	30.10
9	46.7176	0.0792		
10	∞	0.0742	1.51630	64.10
11	∞	0.0829		
12	2.2085	0.0749	1.78472	25.70
13	0.6517	0.2017	1.60342	38.00
14	-6.6704	0.2116		
15	-2.4646	0.1237	1.51728	69.60
16	-1.1253	0.0062		
17	4.9175	0.0619	1.80518	25.40
18	1.3087	0.1856	1.51728	69.60
19	-1.1190			
20				

编号: 07-02-066

鱼 眼 物 镜

E. F. L = 1

B. F. L = 2.3236

FNo. = 3.5

F. A. = $\pm 90^\circ$

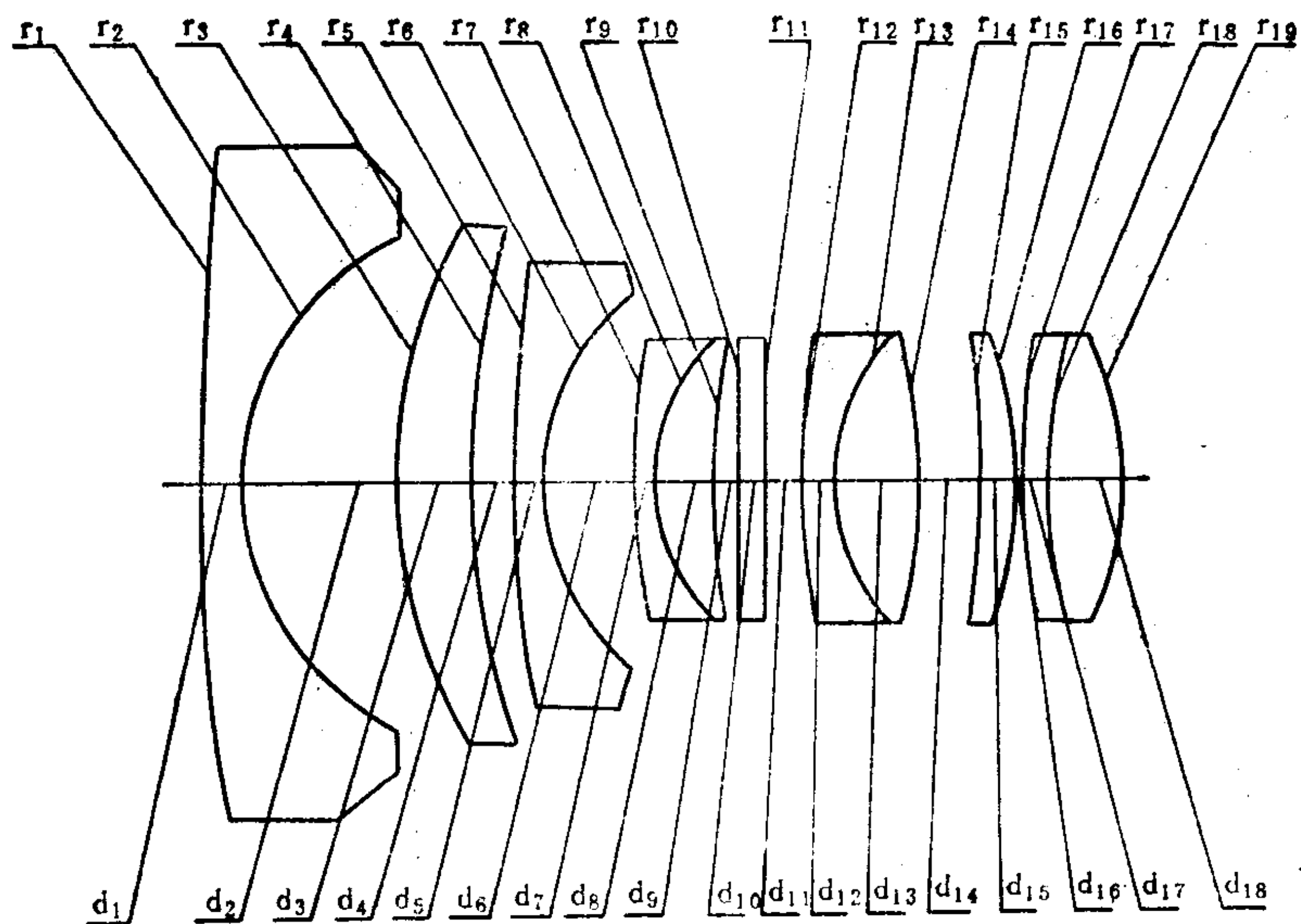

序 号	r	d	n	v
1	5.0022	0.1251	1.58913	61.1
2	0.7760	0.4030		
3	1.4287	0.1876	1.78590	44.2
4	2.3106	0.0938		
5	3.7526	0.0750	1.58913	61.1
6	0.6617	0.2257		
7	1.6285	0.0620	1.69680	55.6
8	0.4808	0.1376	1.69895	30.1
9	14.9131	0.0867		
10	∞	0.0750	1.51630	64.1
11	∞	0.0905		
12	5.0002	0.0684	1.78472	25.7
13	0.5855	0.2098	1.60342	38.0
14	-12.9796	0.2672		
15	-3.7255	0.1251	1.51728	69.6
16	-1.2370	0.0063		
17	3.9866	0.0625	1.80518	25.4
18	1.4291	0.1876	1.51728	69.6
19	-0.9695			
20				

编号: 07-03-067

变 焦 距 物 镜

E. F. L = 1 ~ 2.8537 B. F. L = 1.0915 FNo. = 1.8 F. A. = $\pm 19.5^\circ \sim \pm 6.5^\circ$

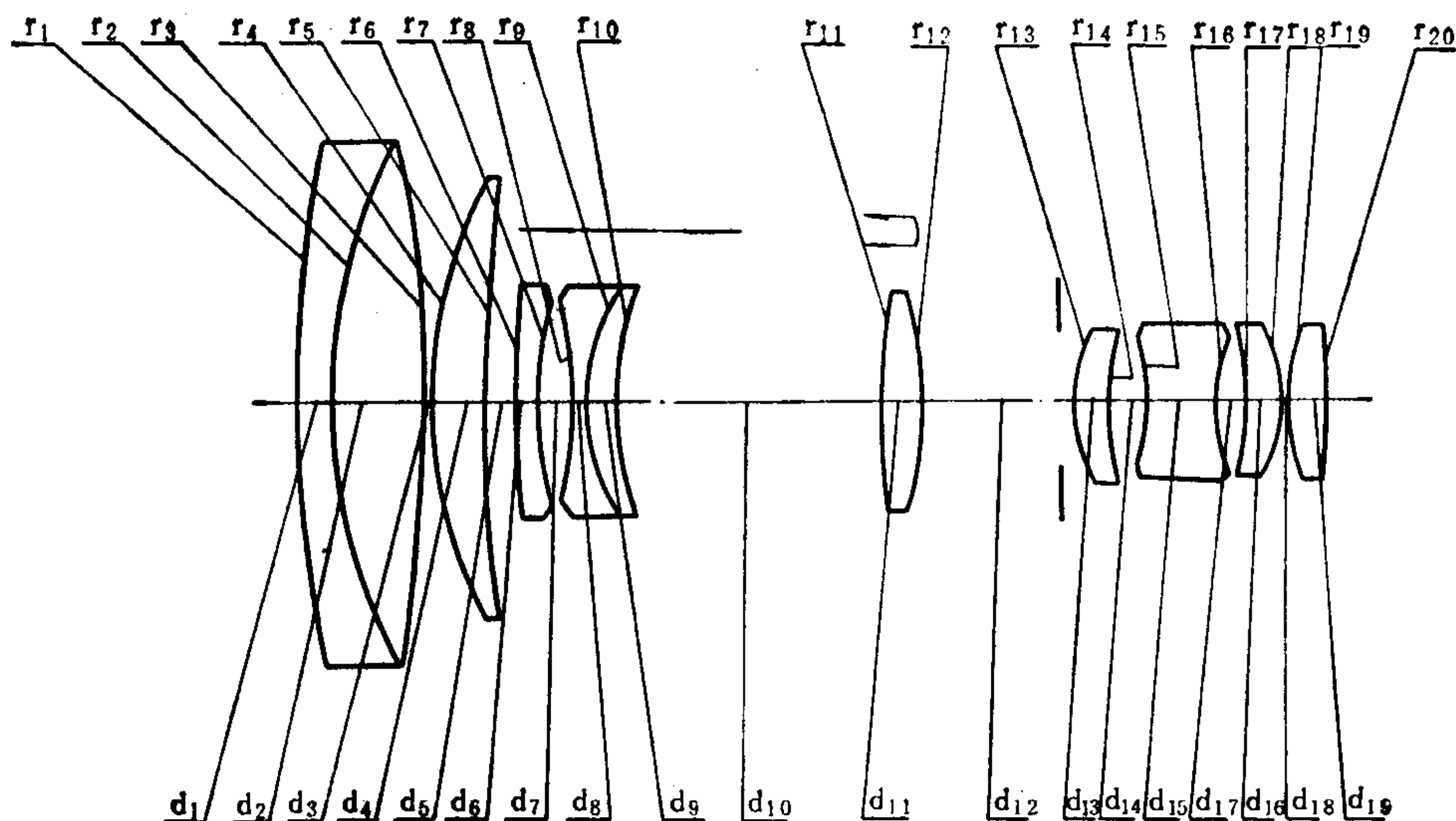

序 号	r	d	n	v
1	10.80075	0.16269	1.75520	27.5
2	3.60009	0.62204	1.58913	61.1
3	-11.32293	0.01435		
4	3.41704	0.38280	1.58913	61.1
5	21.40612	***1		
6	95.63595	0.08613	1.58913	61.1
7	1.75954	0.25839		
8	-2.36774	0.08613	1.58913	61.1
9	1.44821	0.19140	1.80518	25.4
10	3.53483	***2		
11	5.02420	0.19140	1.58913	61.1
12	-5.00752	***3*		
13	1.09030	0.24882	1.71300	54.0
14	28.82289	0.18689		
15	-2.02137	0.53125	1.80518	25.4
16	1.18086	0.11600		
17	-3.11684	0.22968	1.67000	57.4
18	-1.19169	0.00957		
19	1.33736	0.21054	1.77250	49.6
20	-6.74369			

07-03-067-1

	ΣS_1	ΣS_2	ΣS_3	ΣS_4	ΣS_5	HI	QP(1 ω)
	-0.00317	-0.00073	0.00024	-0.00193	-0.00495	0.35	-3.2%
h 或 ω %	LA'	$\Delta H'$	x'_t	x'_s	$x'_t - x'_s$	K'_{T1}	$K'_{T0.7}$
100	-0.00413	-0.0115	-0.0077	-0.0089	0.0012	0.01000	0.00122
70	-0.00692	-0.0036	-0.0038	-0.0051	0.0013	0.00665	0.00064

E. F. L = 1

***1 = 0.13436;

***2 = 1.70762;

***3 = 1.55990;

***3* = 1.55990 = 1.15990 + 0.40000

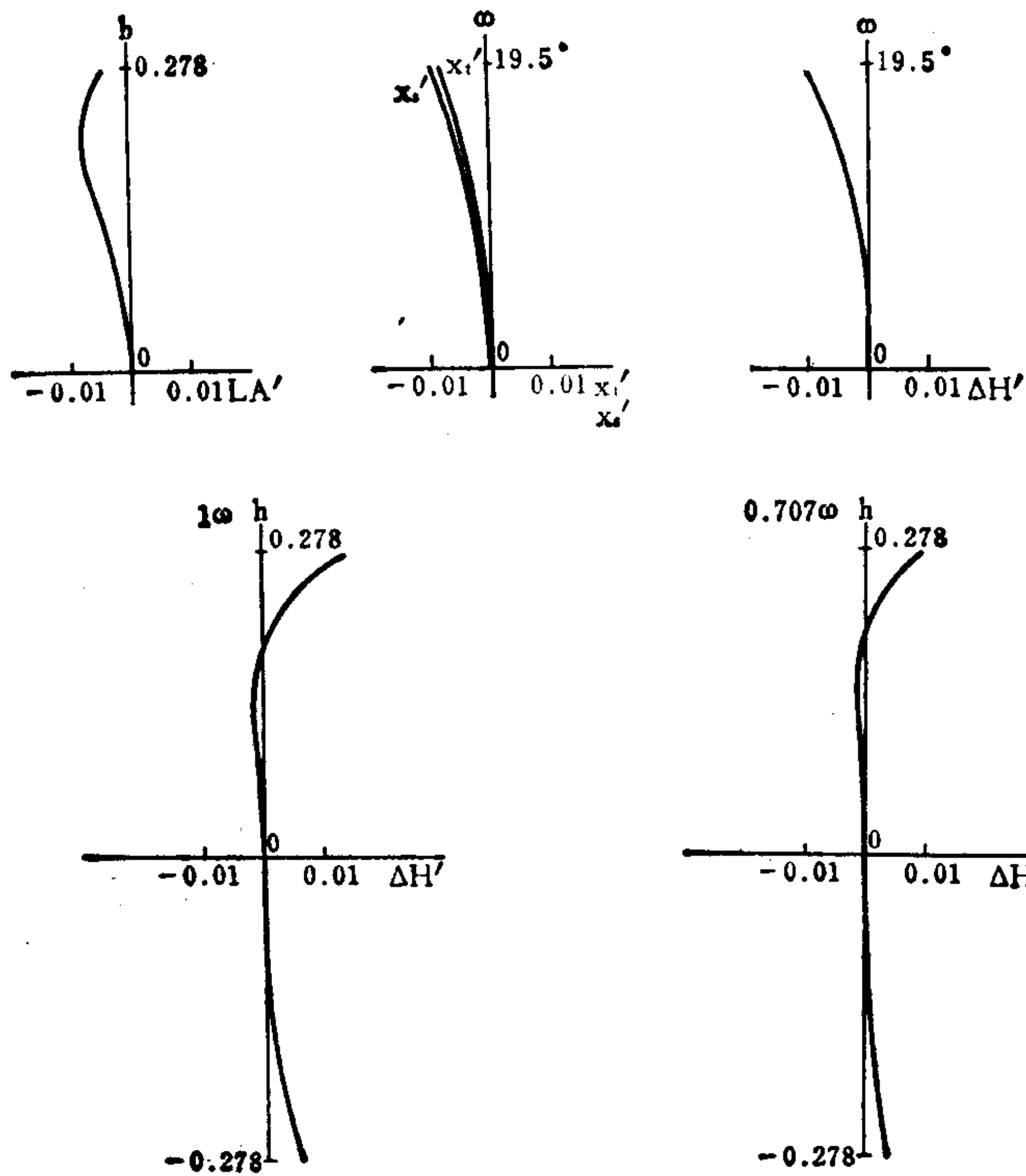

07-03-067-2

	ΣS_1	ΣS_2	ΣS_3	ΣS_4	ΣS_5	HI	QP(1 ω)
	-0.00309	-0.00005	0.00073	-0.00186	0.00313	0.33	2.3%
h 或 ω %	LA'	$\Delta H'$	x'_1	x'_2	$x'_1 - x'_2$	K'_{T1}	$K'_{T0.7}$
100	-0.00389	0.0076	-0.0059	-0.0071	0.0012	0.00547	0.00014
70	-0.00674	0.0023	-0.0012	-0.0039	0.0027	0.00514	0.00023

E. F. L = 1.6859

*** 1 = 1.12092,

*** 2 = 1.12483,

*** 3 = 1.15615,

*** 3* = 1.15615 = 0.75615 + 0.40000

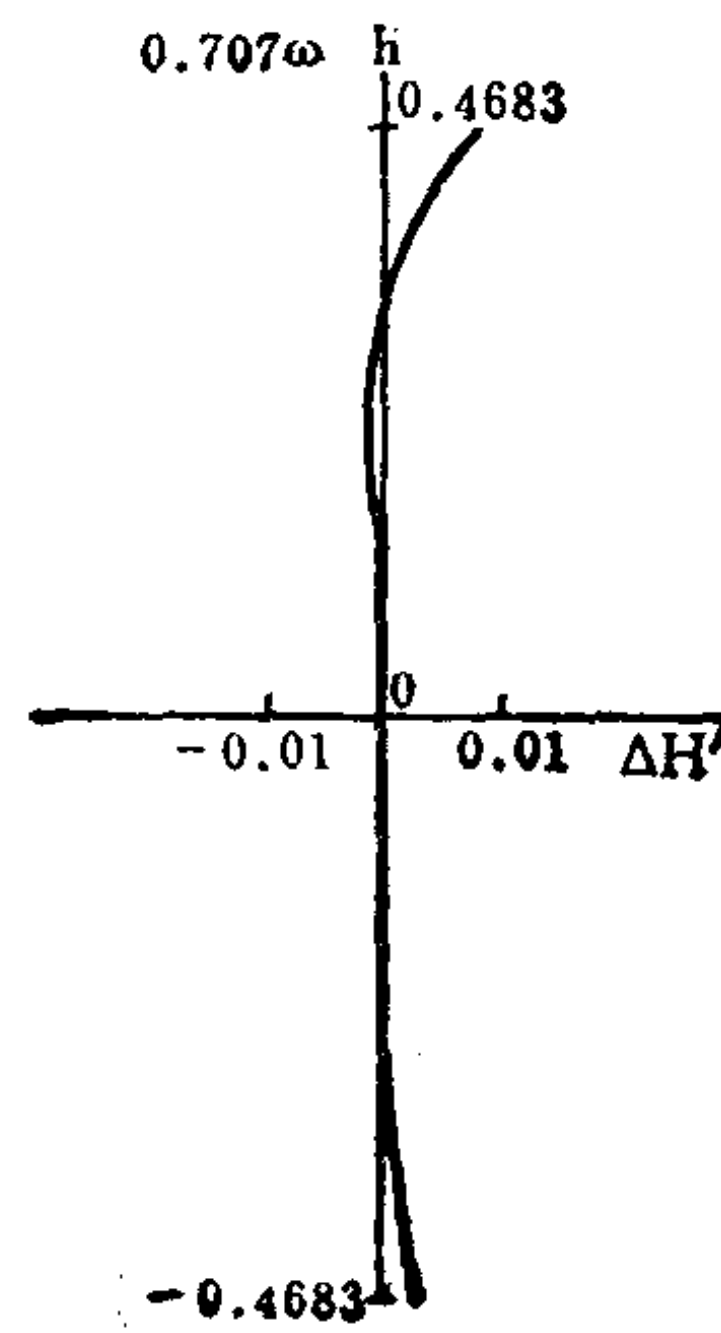
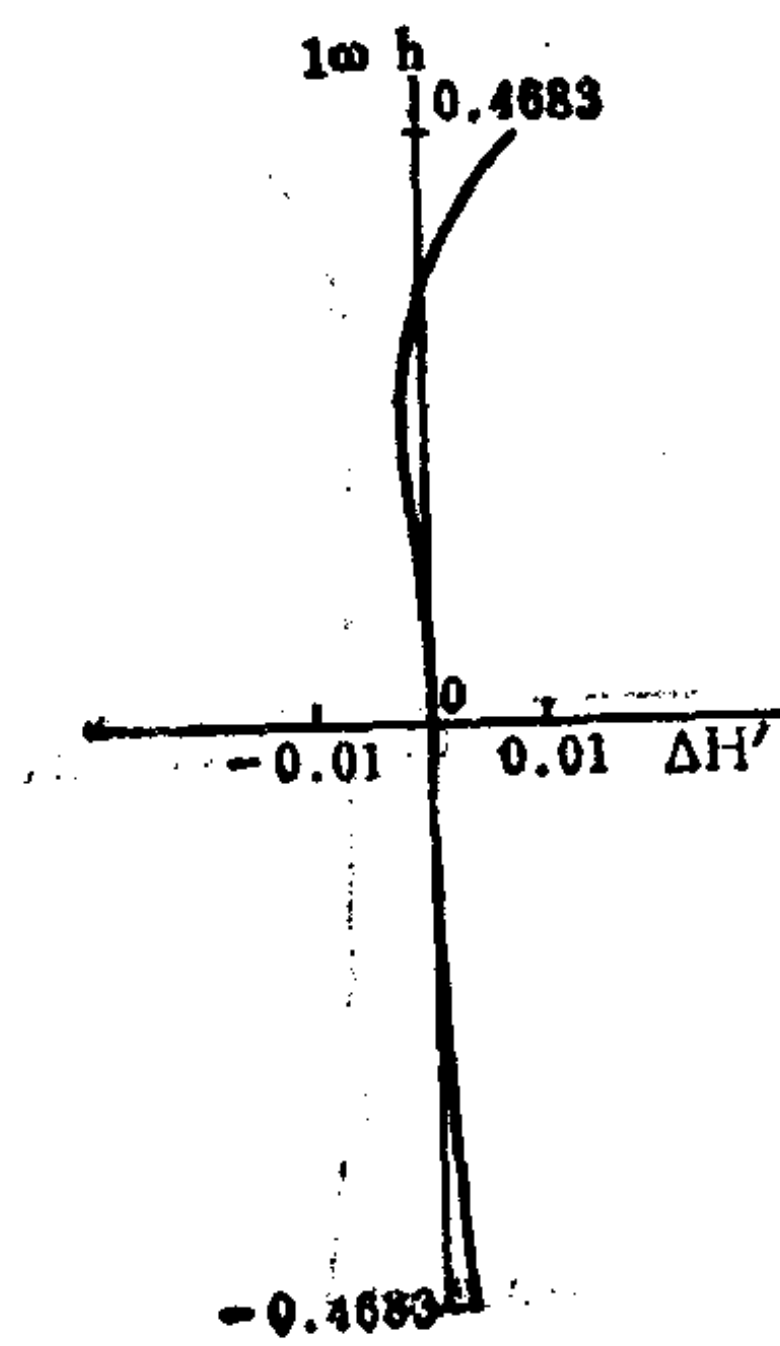
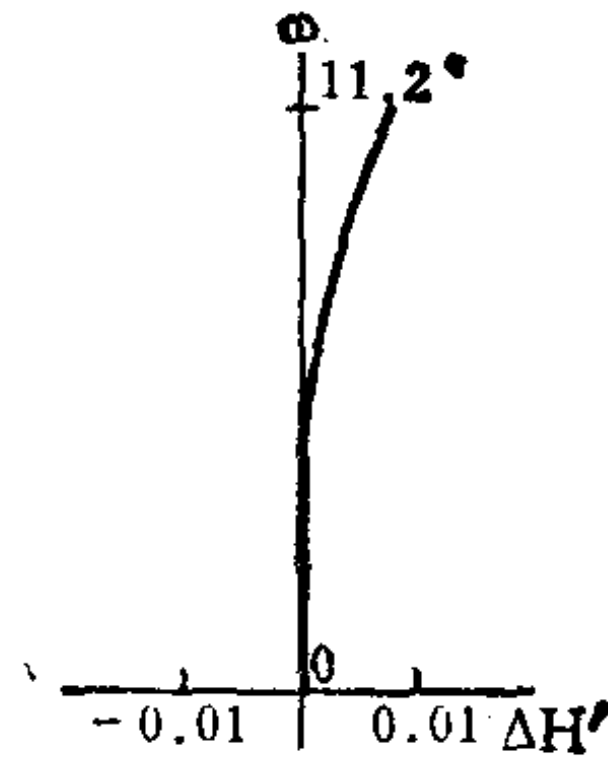
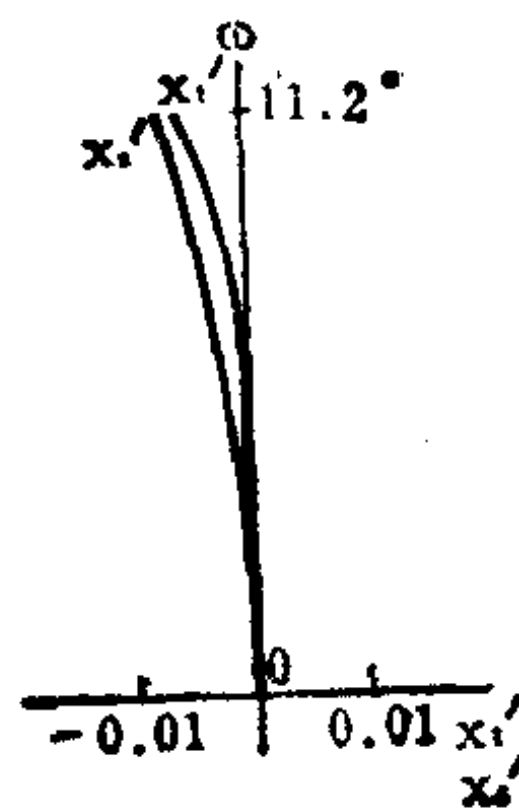
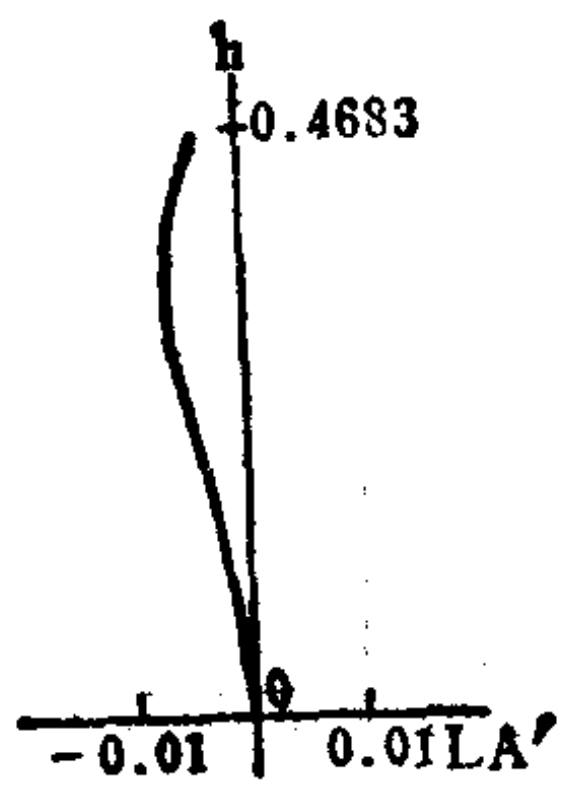

07-03-067-3

	ΣS_1	ΣS_2	ΣS_3	ΣS_4	ΣS_5	HI	QP(1 ω)
	-0.00302	0.00005	0.00053	-0.00181	0.00584	0.32	3.7%
h 或 ω %	LA'	$\Delta H'$	x'_t	x'_s	$x'_t - x'_s$	K_{T1}	$K'_{T0.7}$
100	-0.00462	0.0121	-0.0086	-0.0078	-0.0008	0.00668	0.00073
70	-0.00676	0.0039	-0.0021	-0.0041	0.0020	0.00634	0.00087

E. F. L = 2.8537

*** 1 = 1.70957;

*** 2 = 0.13241;

*** 3 = 1.55990;

*** 3* = 1.55990 = 1.15990 + 0.40000

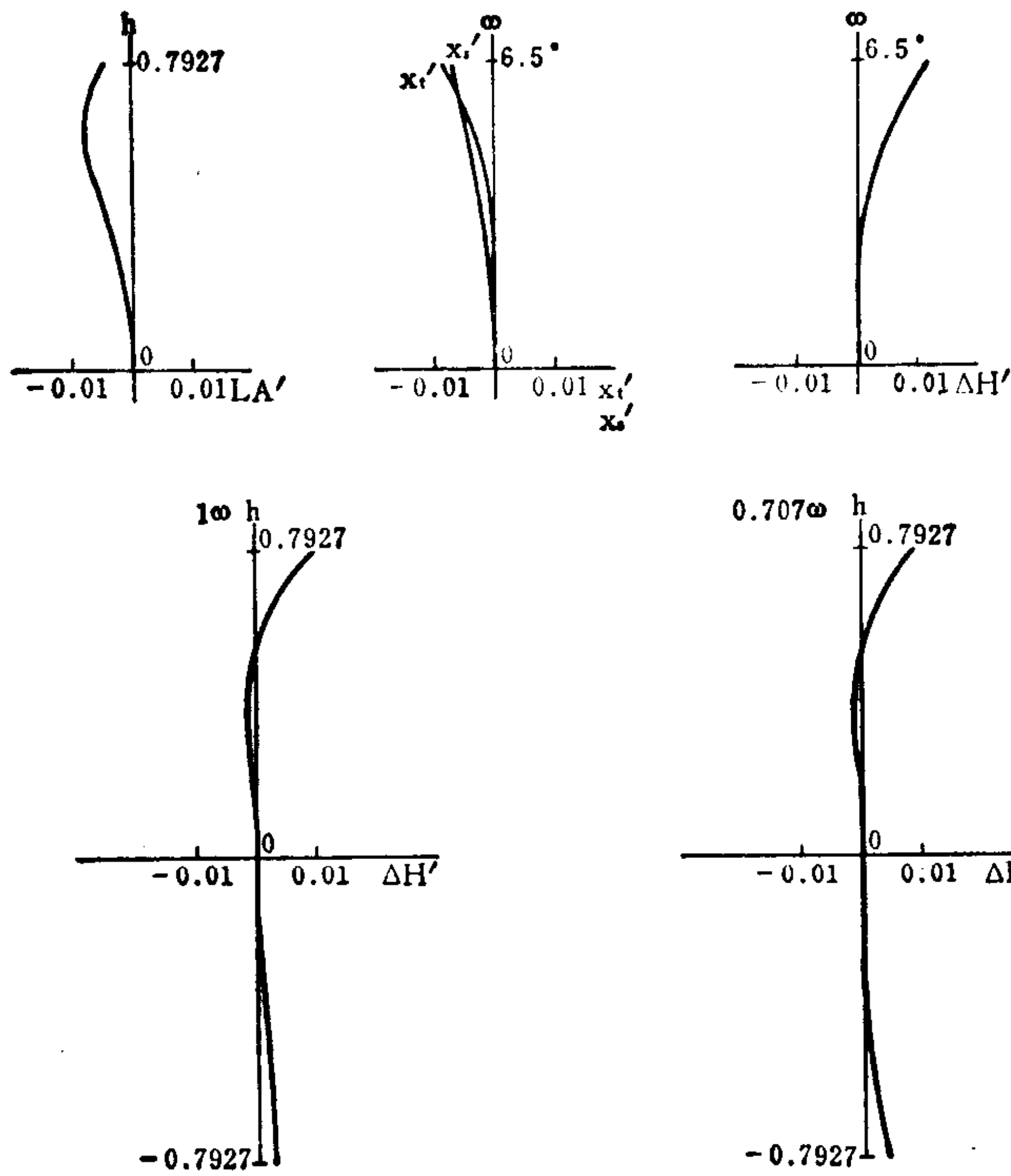

编号: 07-03-068

高变倍率等效变焦距物镜

E. F. L = 1~10 B. F. L = 2.3026 FNo. = 4 F. A. = $\pm 20.6^{\circ}$ ** ~ $\pm 2.06^{\circ}$ **

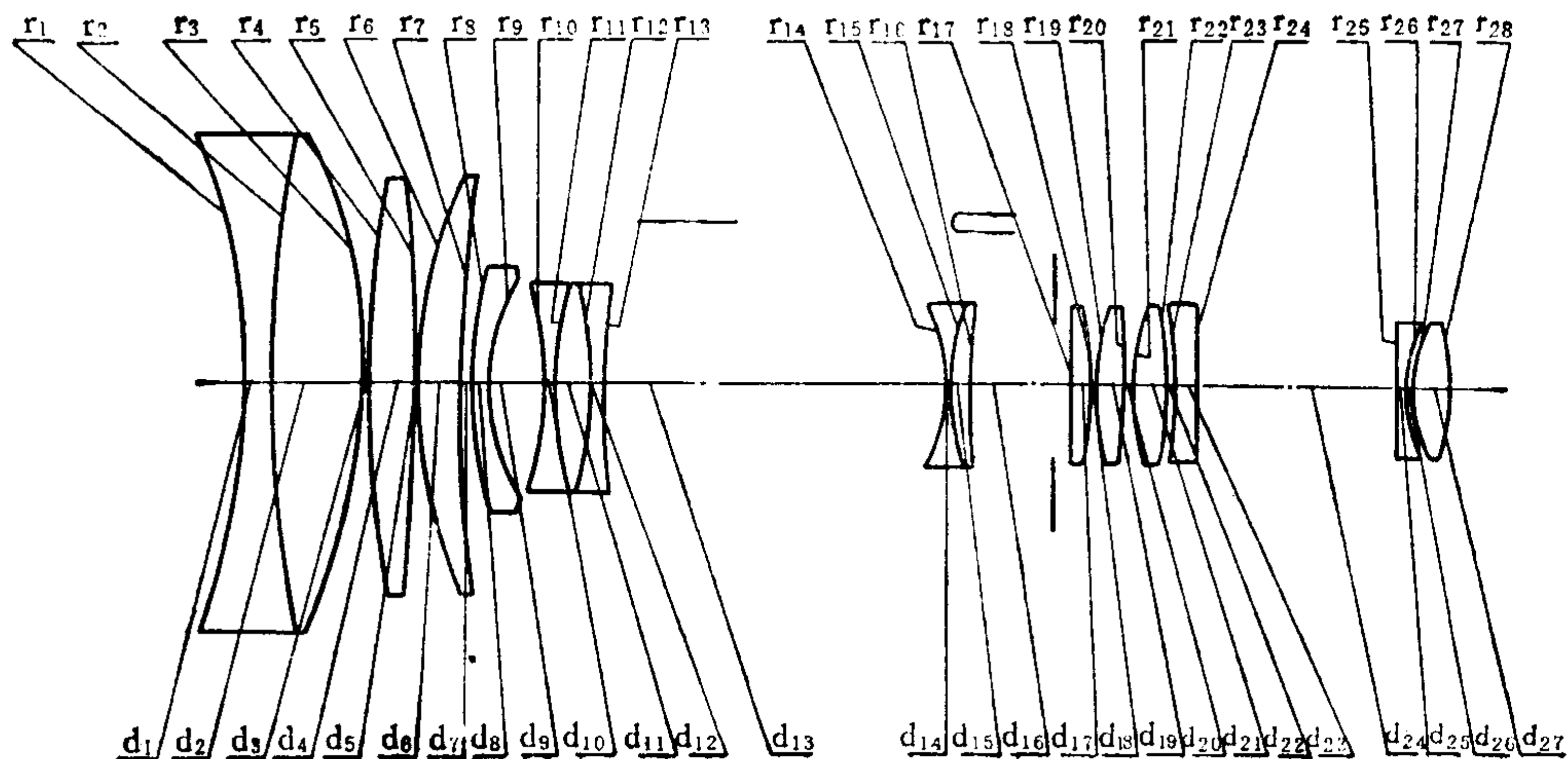

序号	r	d	n	v	序号	r	d	n	v
1	-7.2114	0.2014	1.7847	26.10	15	1.8601	0.1518	1.78470	26.10
2	12.9661	0.8928	1.51507	56.35	16	14.1274	***3*		
3	-5.8567	0.0045			17	∞	0.1911	1.52400	58.87
4	16.2336	0.3661	1.71700	47.90	18	-2.3323	0.0045		
5	-22.5012	0.0045			19	10.6292	0.1910	1.52400	58.87
6	5.6034	0.4241	1.71700	47.90	20	-10.6292	0.0045		
7	24.5154	***1			21	2.7812	0.2678	1.61342	59.27
8	3.9647	0.0804	1.69734	56.19	22	-2.7812	0.0100		
9	1.7362	0.5178			23	-2.5142	0.0893	1.72830	28.66
10	-3.9138	0.0714	1.69734	56.19	24	∞	1.8928		
11	4.4458	0.3036	1.78470	26.10	25	∞	0.0893	1.72830	28.66
12	-4.4458	0.0714	1.69734	56.19	26	1.4266	0.0298		
13	8.2572	***2			27	1.6477	0.2929	1.69734	56.19
14	-1.8601	0.0536	1.69734	56.19	28	-2.7352			

07-03-068-1

	ΣS_1	ΣS_2	ΣS_3	ΣS_4	ΣS_5	HI	QP(1 ω)
	-0.000356	-0.000345	-0.000226	-0.000003	-0.002452	0.37	-2.8%
h 或 ω %	LA'	$\Delta H'$	x'_i	x'_s	$x'_i - x'_s$	K'_{T1}	$K'_{T0.7}$
100	-0.00608	-0.01068	-0.0083	-0.0032	-0.0051	-0.000071	-0.000372
70	-0.00447	-0.00365	-0.0058	-0.0020	-0.0038	-0.000953	-0.000689

E. F. L = 1

***1 = 0.04318,

***2 = 3.63462,

***3 = 1.03190,

***3* = 1.03190 = 0.88190 + 0.15000

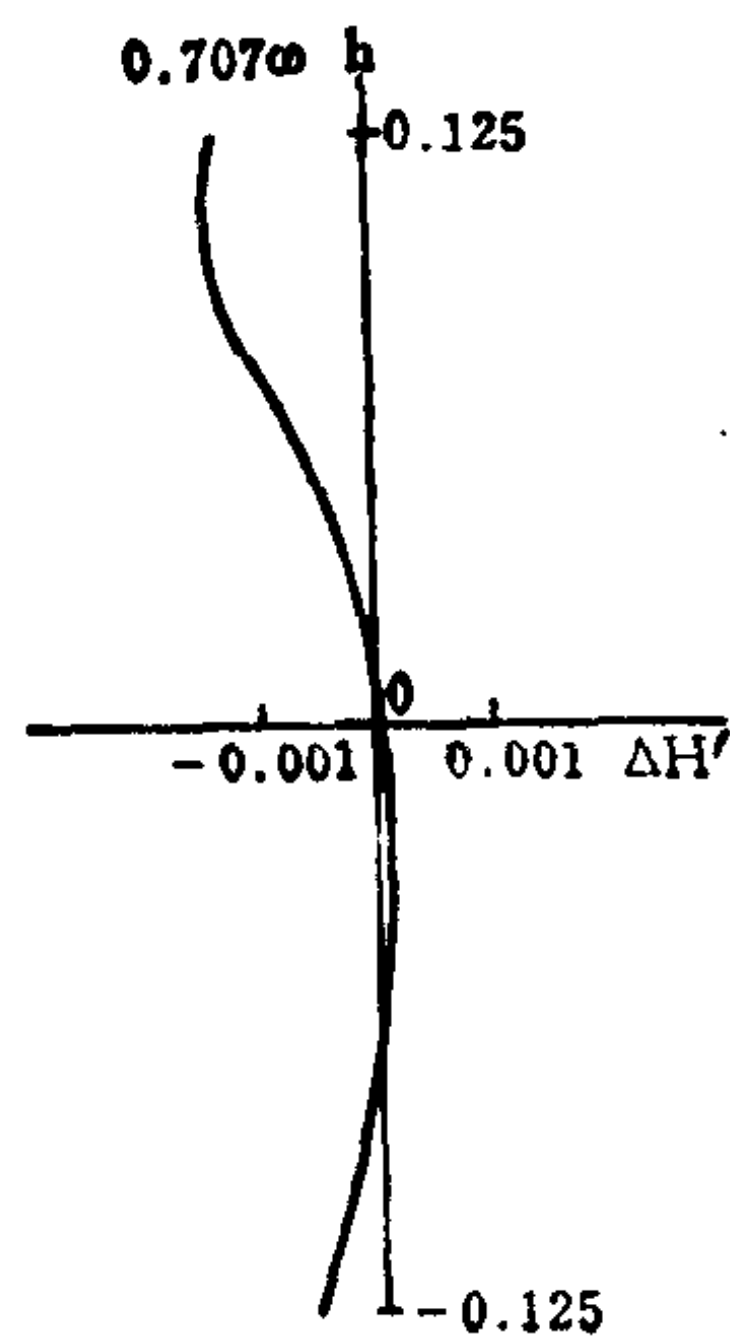
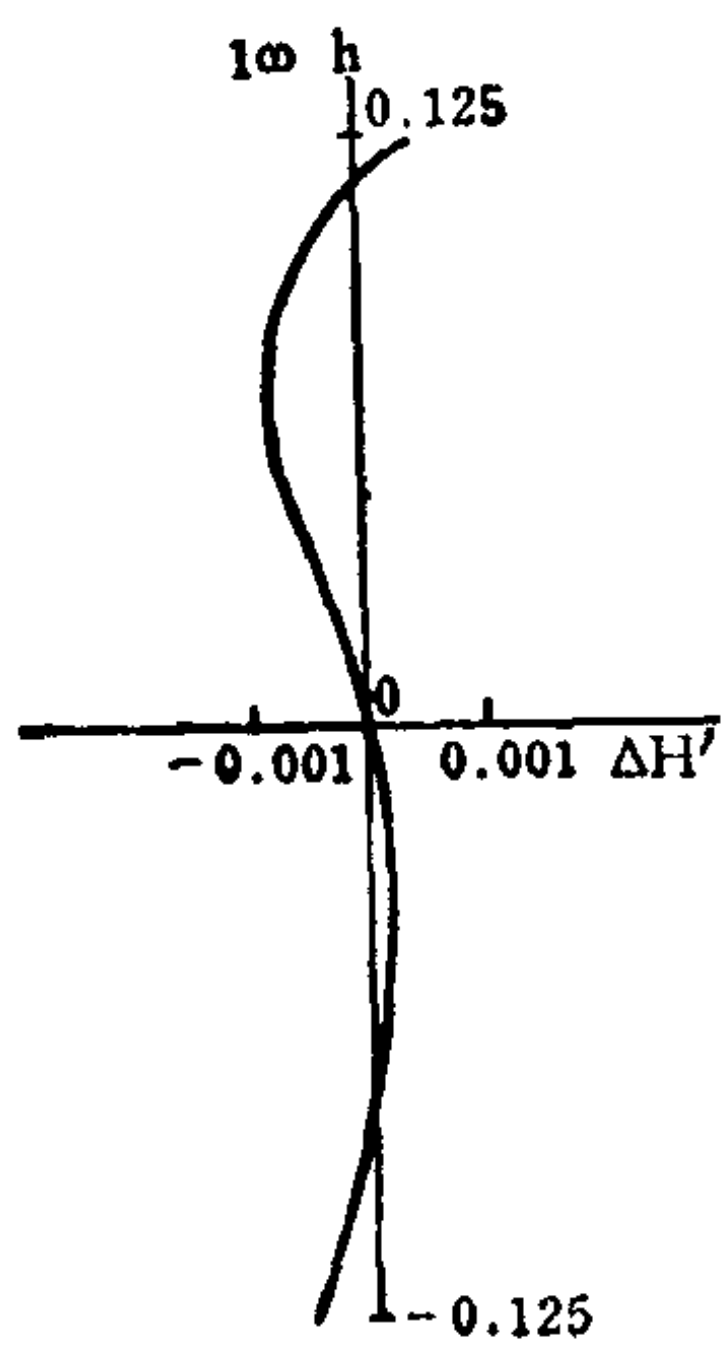
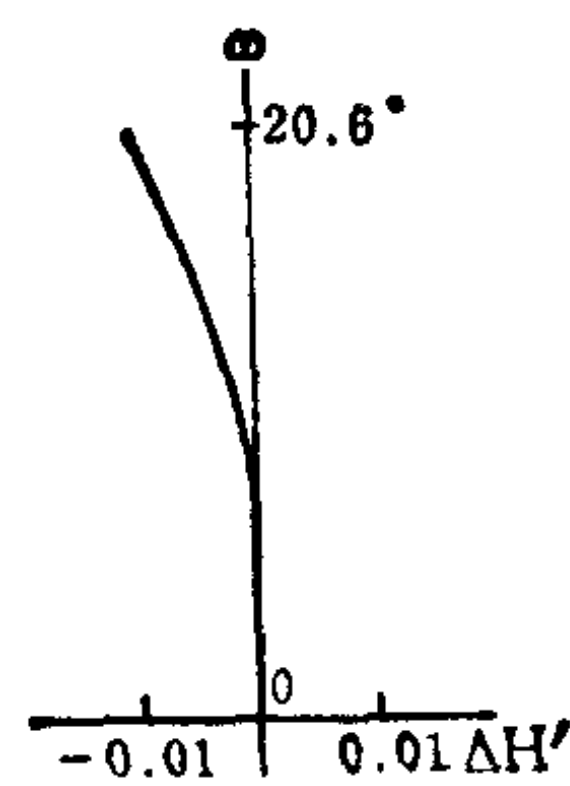
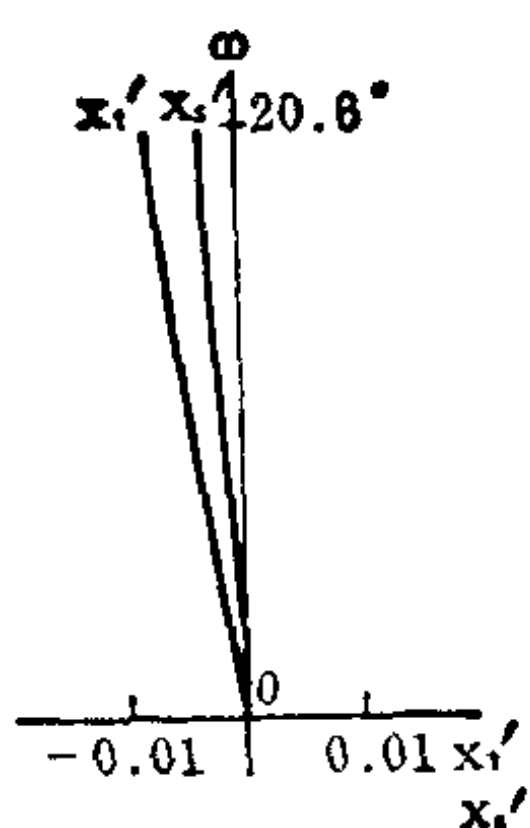
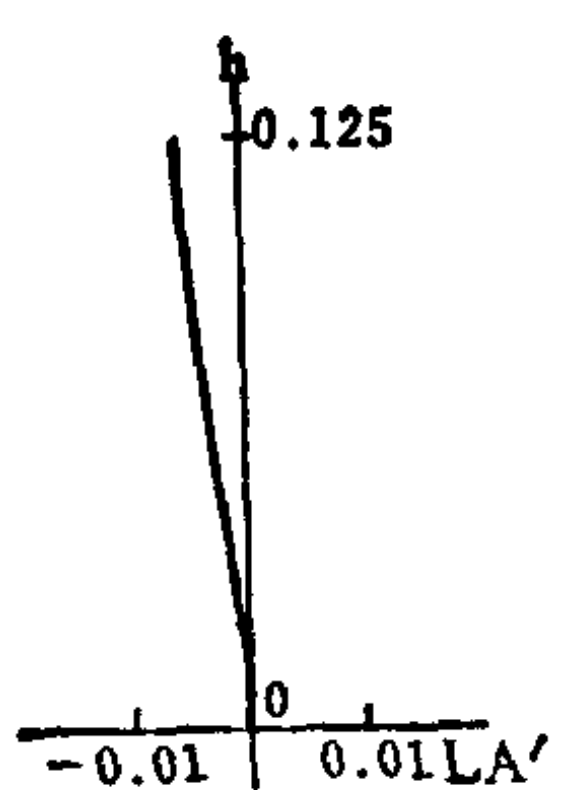

	ΣS_1	ΣS_2	ΣS_3	ΣS_4	ΣS_5	HI	QP(1 ω)
	-0.000336	-0.000159	-0.000151	-0.000003	0.001099	0.36	1.2%
h 或 ω %	LA'	$\Delta H'$	x'_t	x'_s	$x'_t - x'_s$	K'_{T1}	$K'_{T0.7}$
100	-0.00541	0.00463	-0.0168	-0.0064	-0.0104	0.000431	-0.000150
70	-0.00414	0.00149	-0.0108	-0.0037	-0.0071	-0.000568	-0.000508

E. F. L = 1.7787

*** 1 = 1.59156;

*** 2 = 2.01054;

*** 3 = 1.10760;

*** 3* = 1.10760 = 0.95760 + 0.15000

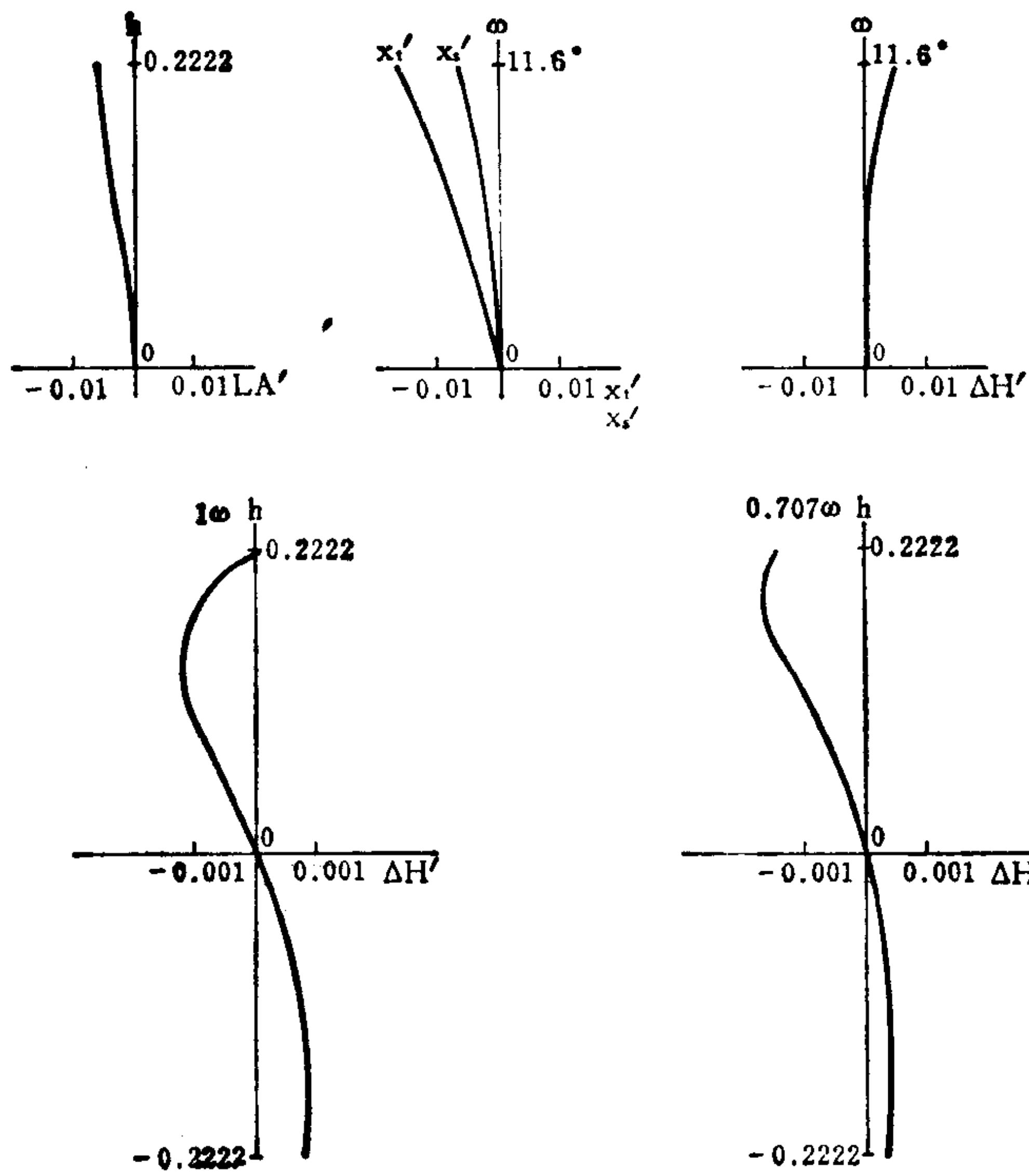

07-03-068-3

	ΣS_1	ΣS_2	ΣS_3	ΣS_4	ΣS_5	HI	QP(1 ω)
	-0.000277	-0.000120	-0.000263	-0.000004	0.001513	0.36	1.7%
h 或 ω %	LA'	$\Delta H'$	x'_1	x'_2	$x'_1 - x'_2$	K'_{T1}	$K'_{T0.7}$
100	-0.00353	0.00613	-0.0176	-0.0070	-0.0106	0.001207	0.000179
70	-0.00319	0.00209	-0.0119	-0.0042	-0.0077	0.000094	-0.000196

E. F. L = 3.1631

*** 1 = 2.76329,

*** 2 = 0.86219,

*** 3 = 1.08422,

*** 3* = 1.08422 = 0.93422 + 0.15000

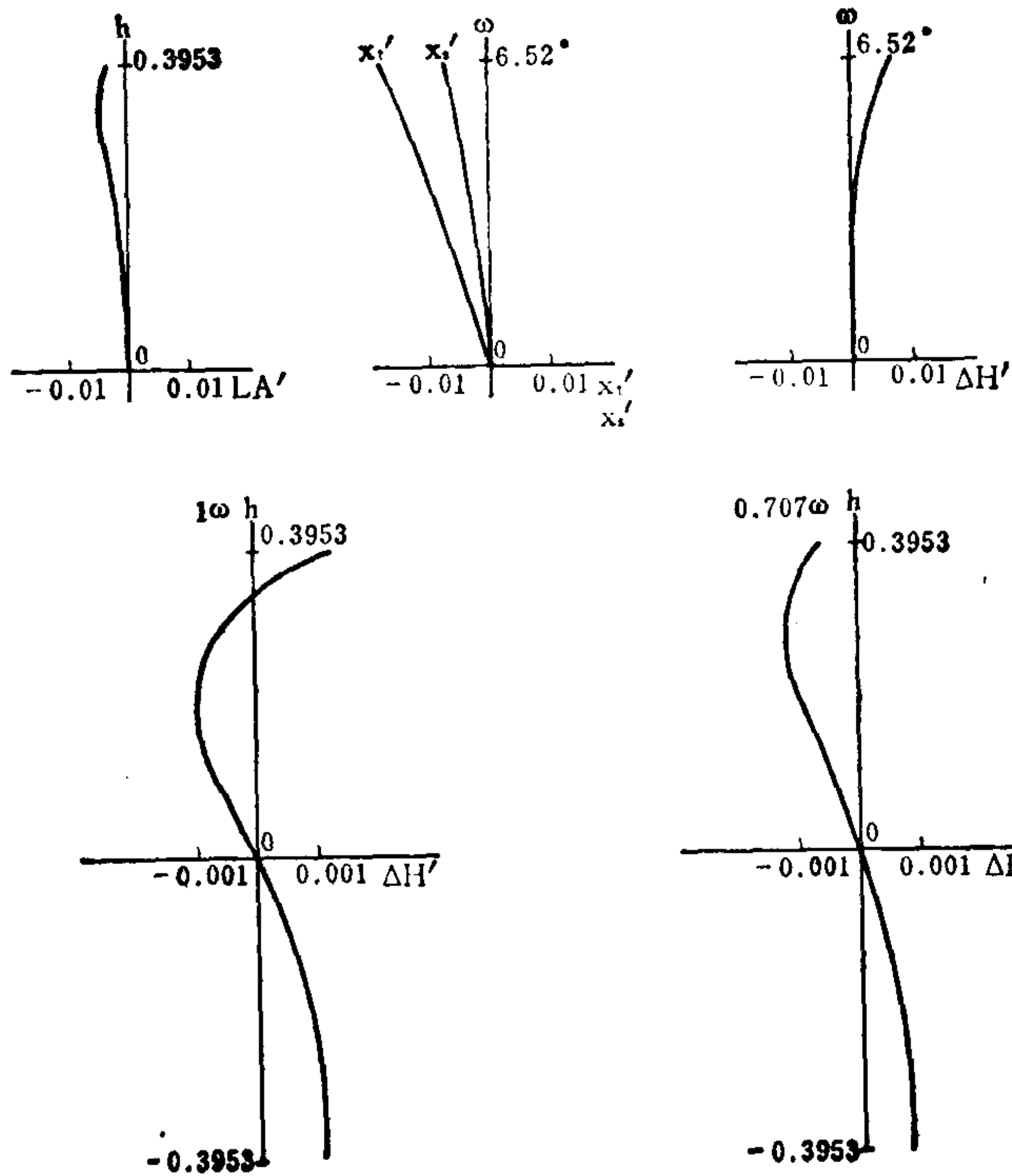

	ΣS_1	ΣS_2	ΣS_3	ΣS_4	ΣS_5	HI	QP(1 ω)
	-0.000222	-0.000015	-0.000277	-0.000004	0.001457	0.36	1.6%
h 或 ω %	I.A'	$\Delta H'$	x'_t	x'_s	$x'_t - x'_s$	K'_{T1}	$K'_{T0.7}$
100	-0.00204	0.00604	-0.01483	-0.00627	-0.00856	0.001859	0.000529
70	-0.00238	0.00207	-0.01081	-0.00389	-0.00692	0.000831	0.000195

E. F. L = 5.6249

* * * 1 = 3.64395;

* * * 2 = 0.23005;

* * * 3 = 0.83569;

* * * 3* = 0.83569 = 0.68569 + 0.15000

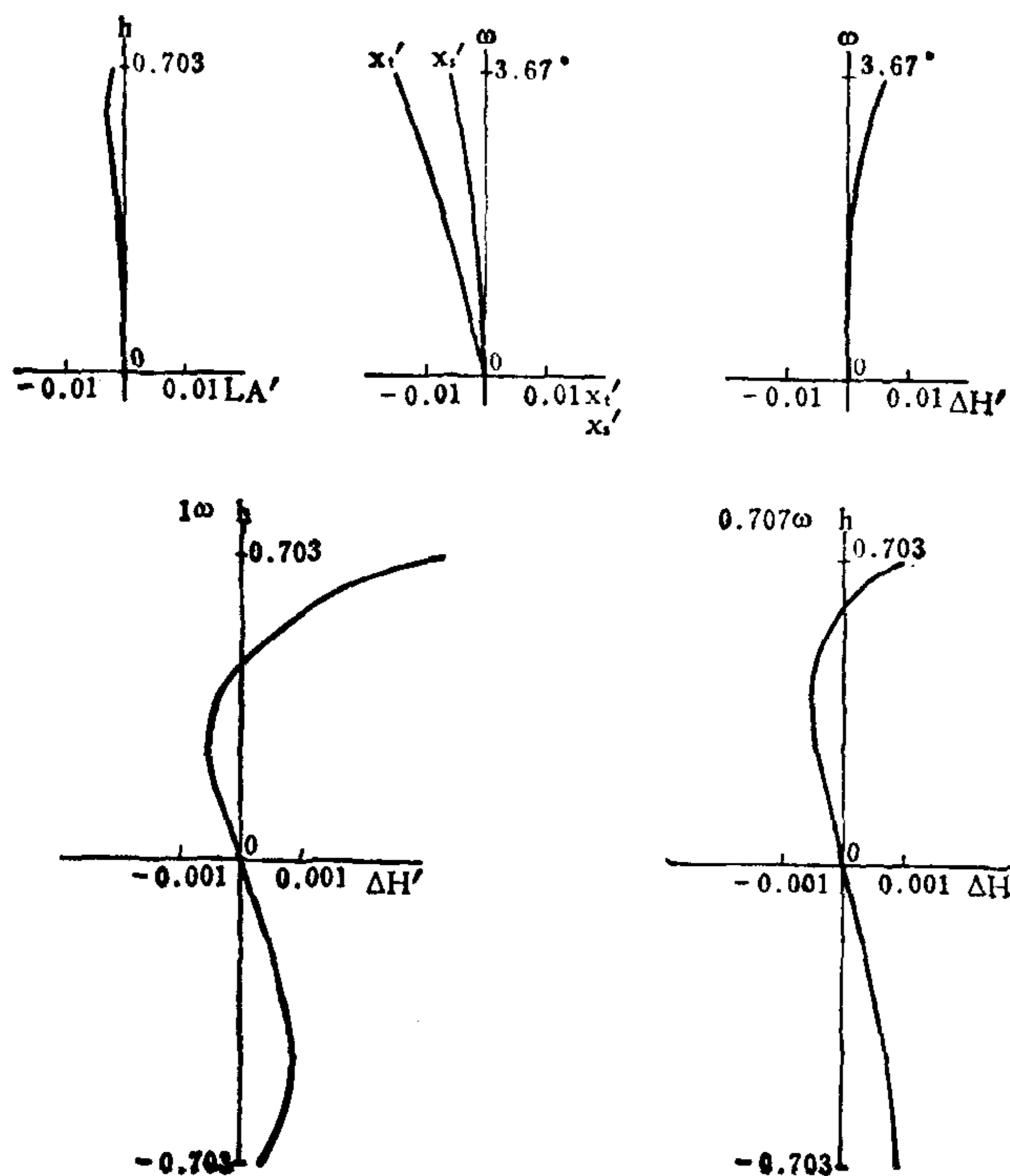

07-03-068-5

	ΣS_1	ΣS_2	ΣS_3	ΣS_4	ΣS_5	HI	QP(1 ω)
	-0.000392	0.000263	-0.000478	-0.000004	0.001474	0.36	1.7%
h 或 ω %	LA'	$\Delta H'$	x'_t	x'_s	$x'_t - x'_s$	K'_{T1}	$K'_{T0.7}$
100	-0.00425	0.00620	-0.0363	-0.0130	-0.0233	0.001184	0.001024
70	-0.00431	0.00212	-0.0207	-0.0071	-0.0136	0.000887	0.000759

E. F. L = 10

***1 = 4.23190;

***2 = 0.23796;

***3 = 0.23984;

***3* = 0.23984 = 0.08984 + 0.15000

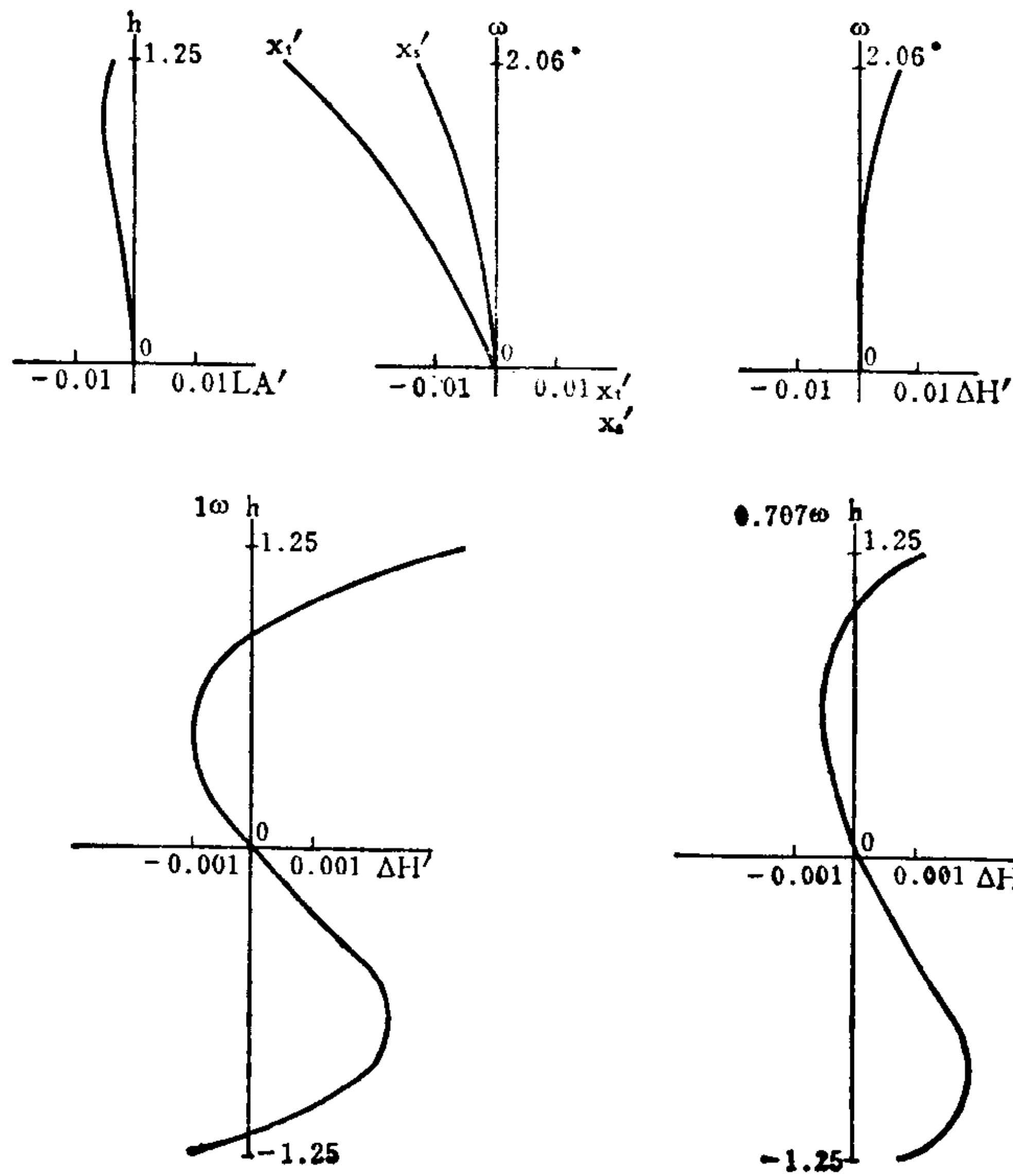

编号: 07-03-069

超高变倍率变焦距物镜

E. F. L = 24 ~ 800 B. F. L = FNo. = 1.8 ~ 4.6 F. A. = ± 19.1' ** ~ ± 0.57' **

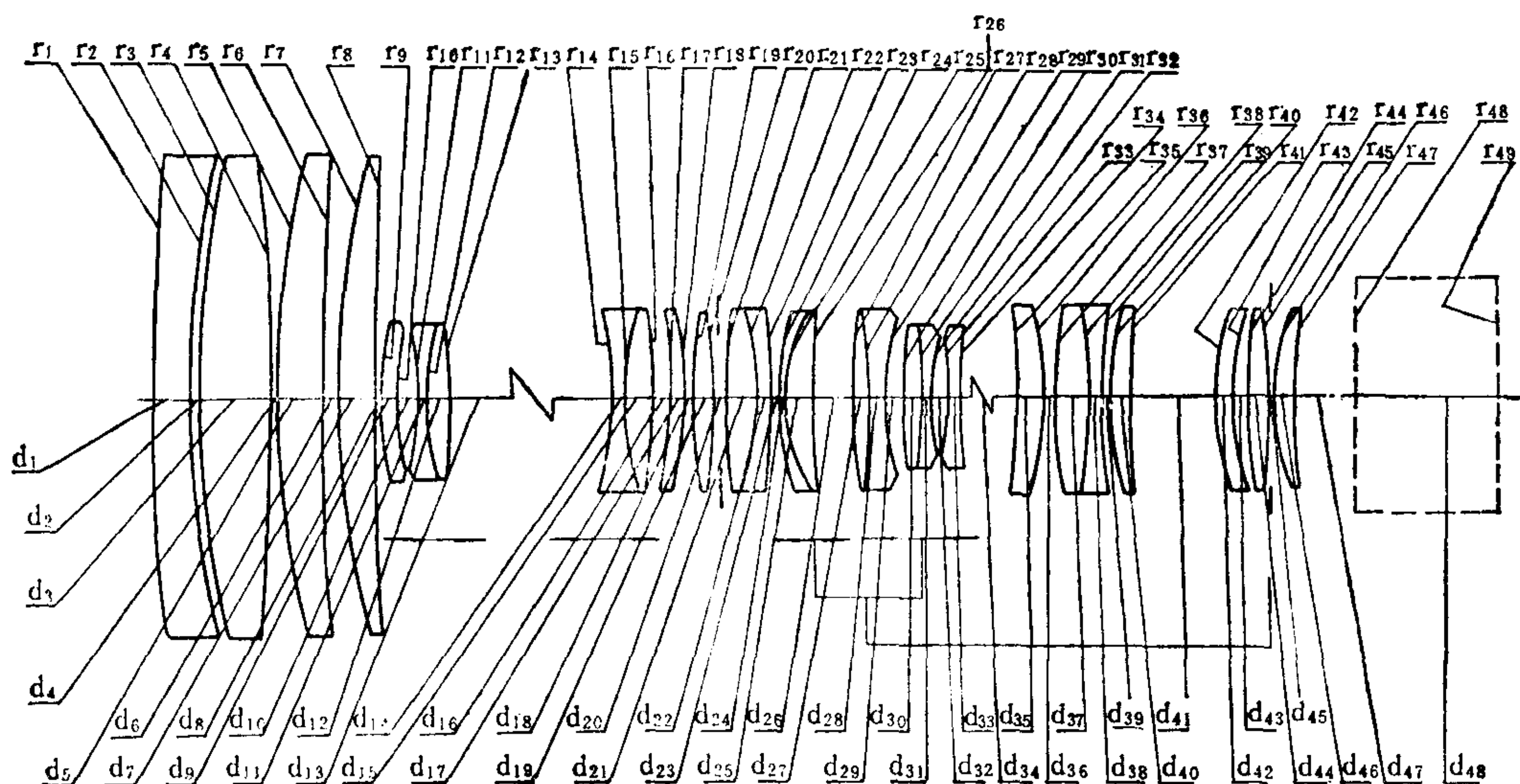

序号	r	d	n	v	序号	r	d	n	v
1	1086.3900	8.000	1.75520	27.50	26	431.9450	***4		
2	283.6800	1.480			27	138.1450	5.957	1.71736	29.50
3	280.9100	23.310	1.51633	64.10	28	-633.9210	2.500	1.72000	50.30
4	-1173.2600	0.200			29	59.1800	***5		
5	289.5460	17.620	1.51633	64.10	30	123.2700	4.772	1.92286	21.00
6	1566.3700	0.200			31	-382.7700	2.500	1.81600	46.80
7	278.2680	13.270	1.51633	64.10	32	69.0452	6.815		
8	921.8920	***1			33	-74.2236	2.500	1.81600	46.80
9	364.9300	3.000	1.81600	46.80	34	413.7010	***6		
10	70.6900	9.000			35	-600.2110	7.736	1.60311	60.70
11	-87.0000	2.520	1.81600	46.80	36	-109.2490	0.200		
12	96.2450	6.000	1.92286	21.00	37	146.8290	11.823	1.60311	60.70
13	-788.2500	***2			38	-139.7300	3.000	1.80518	25.40
14	-101.8000	3.020	1.78590	44.20	39	1373.0500	0.200		
15	100.0800	10.000	1.80518	25.40	40	129.3180	7.872	1.60311	60.70
16	-3088.0000	***3			41	1539.5200	29.808		
17	-2040.0000	6.000	1.48749	70.10	42	110.4320	3.000	1.71736	29.50
18	-104.1800	0.200			43	70.8992	6.566		
19	261.6900	6.500	1.48749	70.10	44	162.8080	6.778	1.51633	64.10
20	-200.3300	3.511			45	-360.1620	0.200		
21	234.5810	12.782	1.60311	60.70	46	79.4534	7.974	1.51633	64.10
22	-88.1214	3.500	1.80518	25.40	47	652.0880	20.000		
23	-289.9800	0.200			48	∞	69.200	1.51633	64.10
24	79.5181	3.000	1.75520	27.50	49	∞			
25	54.7653	10.476	1.62041	60.30					

E. F. L = 24 ~ 234.2 ~ 800

***1 = 0.5517 183.9580 228.8850

***2 = 235.6810 29.5934 7.3484

***3 = 5.9945 28.6778 5.9945

***4 = 13.1102 17.6795 16.5754

***5 = 7.1707 26.2014 43.7055

***6 = 42.8562 19.2562 2.8562

变倍比 1:33.3

编号: 07-03-070

大孔径高变倍率变焦距物镜

E. F. L = 7.5 ~ 60 B. F. L = FNo. = 1.4 F. A. = ± 27.5' ** ~ ± 3.44' **

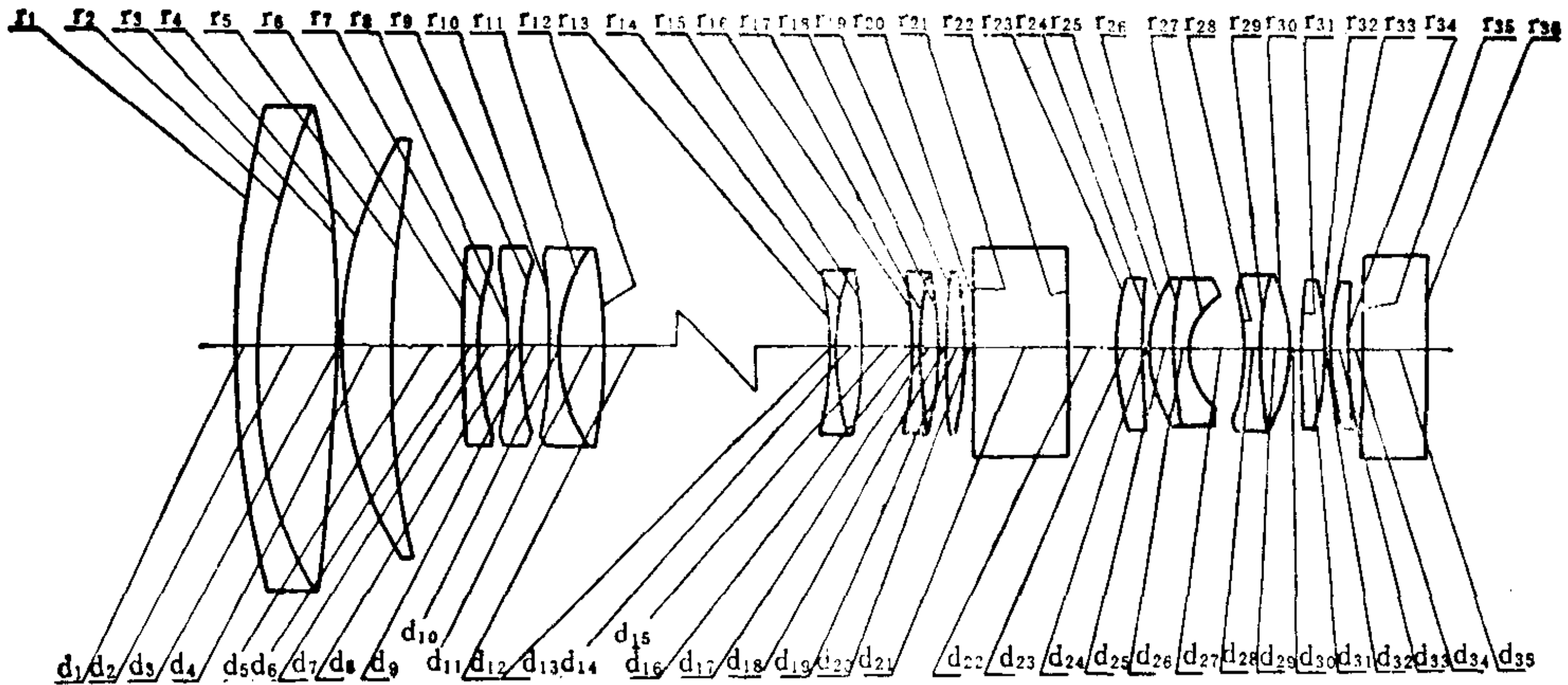

序号	r	d	n	v	序号	r	d	n	v
1	131.918	1.72	1.80518	25.4	19	224.854	1.50	1.64000	60.2
2	55.365	8.50	1.64000	60.2	20	-59.960	0.70		
3	-198.061	0.10			21	∞	11.00	1.63854	55.4
4	43.354	5.00	1.64000	60.2	22	∞	5.50		
5	94.875	***1			23	21.700	3.15	1.75700	47.9
6	104.043	0.70	1.71300	54.0	24	65.650	0.10		
7	19.844	3.20			25	11.500	3.88	1.71300	54.0
8	-38.740	0.70	1.77250	49.6	26	36.000	1.59	1.80518	25.4
9	36.985	2.30			27	8.130	6.29		
10	-101.786	0.70	1.72342	38.0	28	-13.800	1.72	1.78470	26.2
11	16.543	4.50	1.78470	26.2	29	49.460	3.90	1.67790	53.3
12	-72.304	***2			30	-18.660	1.76		
13	-27.427	0.60	1.78590	44.2	31	137.390	2.36	1.66446	35.8
14	24.284	2.50	1.75520	27.5	32	-31.920	0.10		
15	-199.487	***3			33	21.420	1.80	1.59270	35.6
16	-319.952	0.60	1.69895	30.1	34	1051.429	1.20		
17	276.454	2.50	1.69680	55.7	35	∞	6.80	1.63854	55.4
18	-33.288	0.10			36	∞			

E. F. L = 7.5 ~ 25 ~ 60
 ***1 = 8.27415 36.29100 46.96344
 ***2 = 50.01980 18.88531 11.71152
 ***3 = 5.97179 9.08944 5.59079
 变倍比 1:8
 $f_I = 68.7$ ($r_1 \sim r_5$)
 $f_{II} = -16.2$ ($r_6 \sim r_{12}$)
 $f_{III} = -38.5$ ($r_{13} \sim r_{15}$)
 $f_{IV} = 31.1$ ($r_{16} \sim r_{22}$)
 $f_V = 26.6$ ($r_{23} \sim r_{36}$)

编号: 07-03-071

大孔径高变倍率变焦距物镜

E.F.L.=7.5~60 B.F.L.= FNo.=1.4 F.A.=±27.5°**~±3.44°**

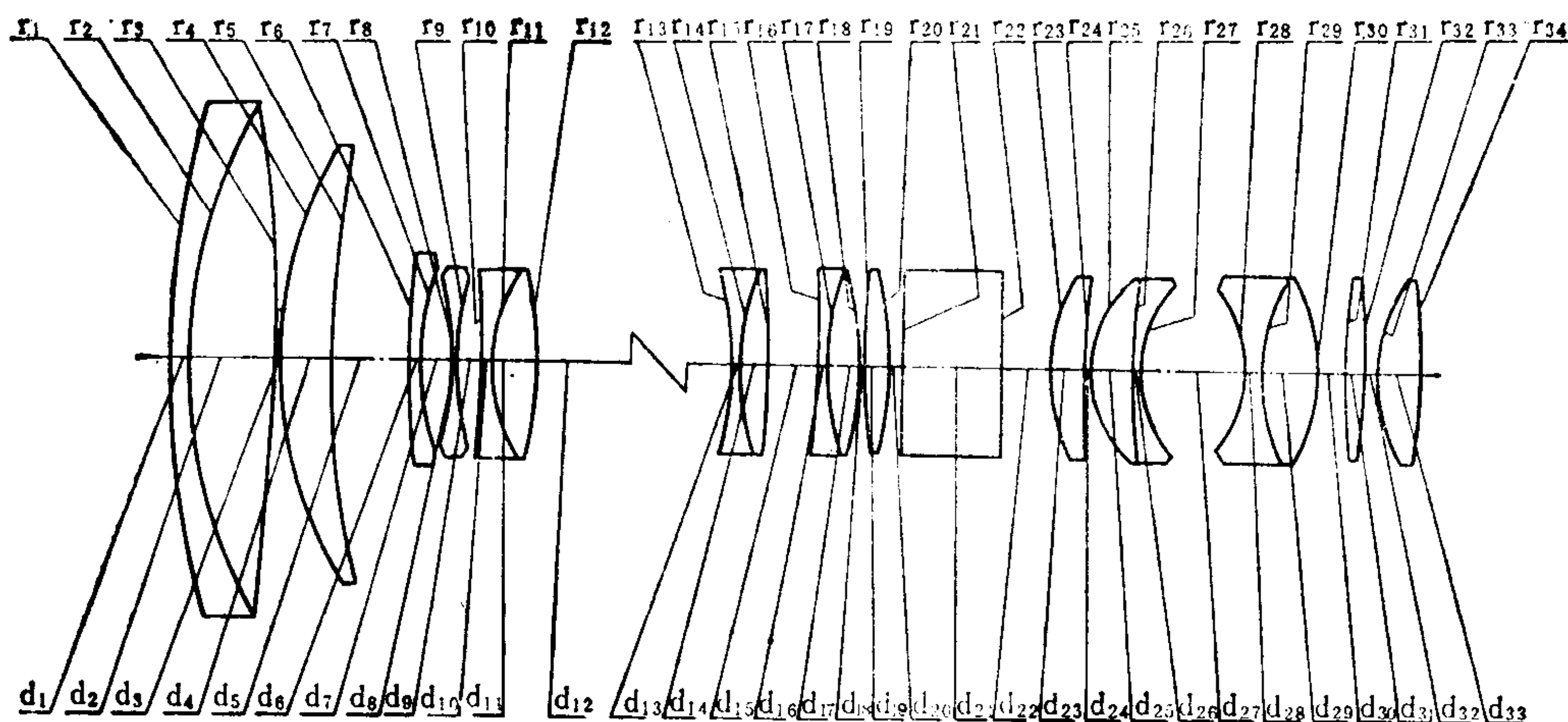

序号	r	d	n	v	序号	r	d	n	v
1	128.457	1.72	1.80518	25.4	18	-33.322	0.10		
2	54.760	8.50	1.64000	60.2	19	260.325	1.50	1.64000	60.2
3	-195.445	0.10			20	-58.944	0.70		
4	43.667	5.00	1.64000	60.2	21	∞	11.00	1.63854	55.4
5	93.917	***1			22	∞	5.50		
6	103.965	0.70	1.71300	54.0	23	24.095	3.15	1.75700	47.9
7	19.729	3.20			24	84.060	0.10		
8	-39.198	0.70	1.77250	49.6	25	12.448	4.30	1.71300	54.0
9	37.675	2.30			26	41.129	1.59	1.80518	25.4
10	-96.497	0.70	1.72342	38.0	27	8.827	11.12		
11	16.418	4.50	1.78470	26.2	28	-12.900	1.72	1.78470	26.2
12	-72.239	***2			29	20.993	5.98	1.67790	53.3
13	-27.536	0.60	1.78590	44.2	30	-18.011	1.76		
14	24.562	2.50	1.75520	27.5	31	47.998	2.36	1.66446	35.8
15	-206.054	***3			32	-45.738	0.10		
16	-360.023	0.60	1.69895	30.1	33	19.233	3.75	1.59270	35.6
17	278.930	2.50	1.69680	55.7	34	-567.303			

E.F.L.=7.5 ~ 25 ~ 60
 ***1=8.27415 36.29100 46.96344
 ***2=50.01980 18.88531 11.71152
 ***3=5.97179 9.08944 5.59079
 变倍比 1:8
 $f_I = 68.7 (r_1 \sim r_5)$
 $f_{II} = -16.2 (r_6 \sim r_{12})$
 $f_{III} = -38.5 (r_{13} \sim r_{15})$
 $f_{IV} = 31.1 (r_{16} \sim r_{22})$
 $f_V = 26.6 (r_{23} \sim r_{34})$

编号: 07-04-072

明亮的投影物镜

E.F.L = 100

B.F.L = 144.6

NA = 0.06

$\eta = 94.03$

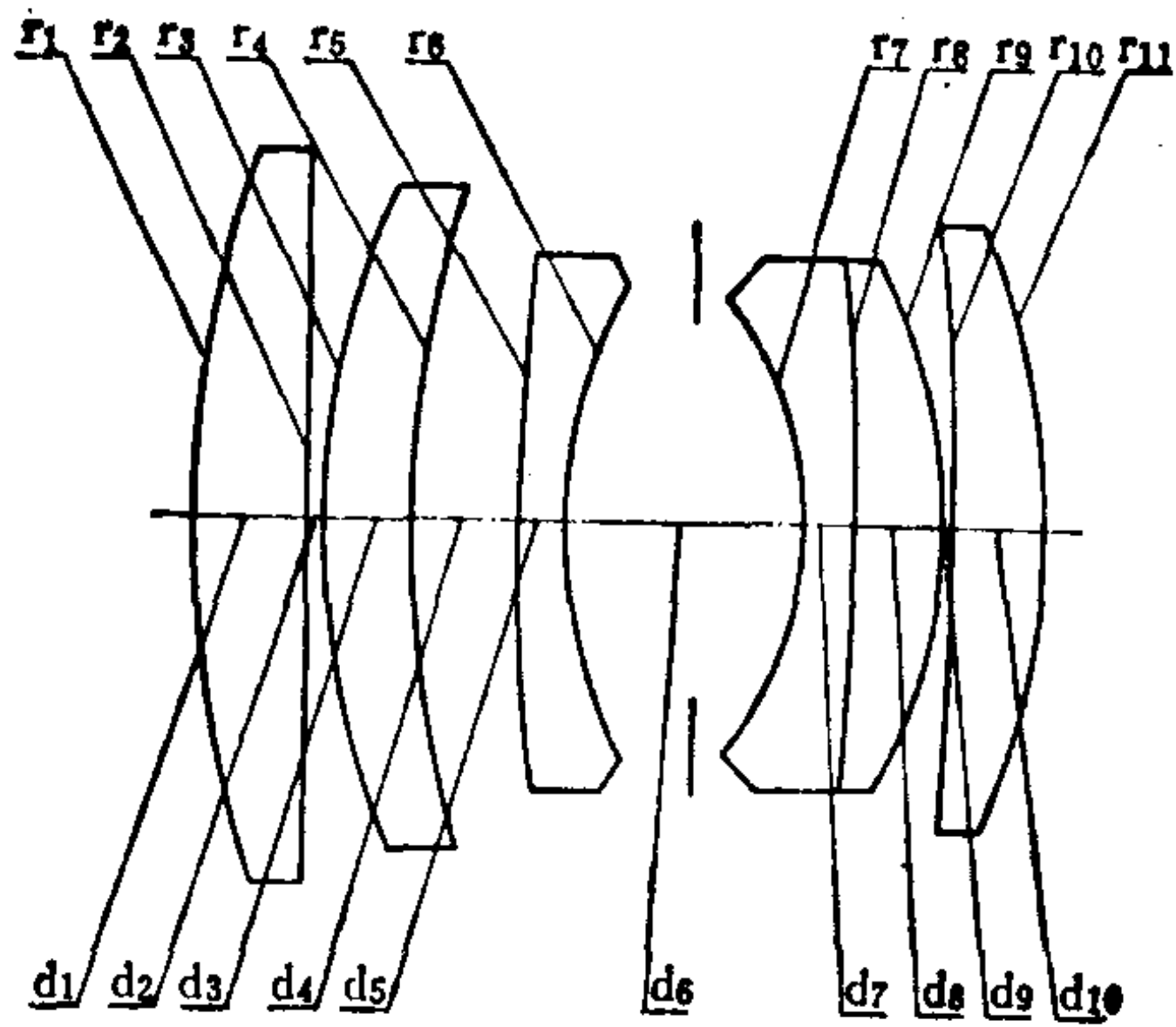

序号	r	d	n	v	序号	r	d	n	v
1	65.7827	6.314	1.63854	55.38	7	-22.1345	3.372	1.57501	41.49
2	∞	0.537			8	-133.3642	5.051	1.67790	55.33
3	45.4964	5.424	1.63854	55.38	9	-32.6426	0.202		
4	80.8231	6.106			10	-367.2337	5.051	1.63854	55.38
5	196.5133	3.227	1.71736	29.51	11	-47.6287			
6	34.5551	13.562*							

$13.562^* = 6.781 + 6.781$

	ΣS_1	ΣS_2	ΣS_3	ΣS_4	ΣS_5	HI	QP(1 η)
	-0.01309	-0.01473	0.00874	-0.06761	0.00633	63	-0.08%
NA或 η %	LA'	$\Delta H'$	x'_t	x'_s	$x'_t - x'_s$	K'_{f1}	$K'_{f0.7}$
100	0.0714	-0.0506	-0.457	-0.917	0.460	-0.0218	0.1512
70	-0.2012	-0.0212	-0.638	-1.229	0.591	-0.0676	0.0678

注: 以上象差值是在 $l = -216.396$ 、 $\eta = 94.03$ 、 $M = -0.67^*$ 及 $F/3.3$ (NA = 0.06) 时计算的。

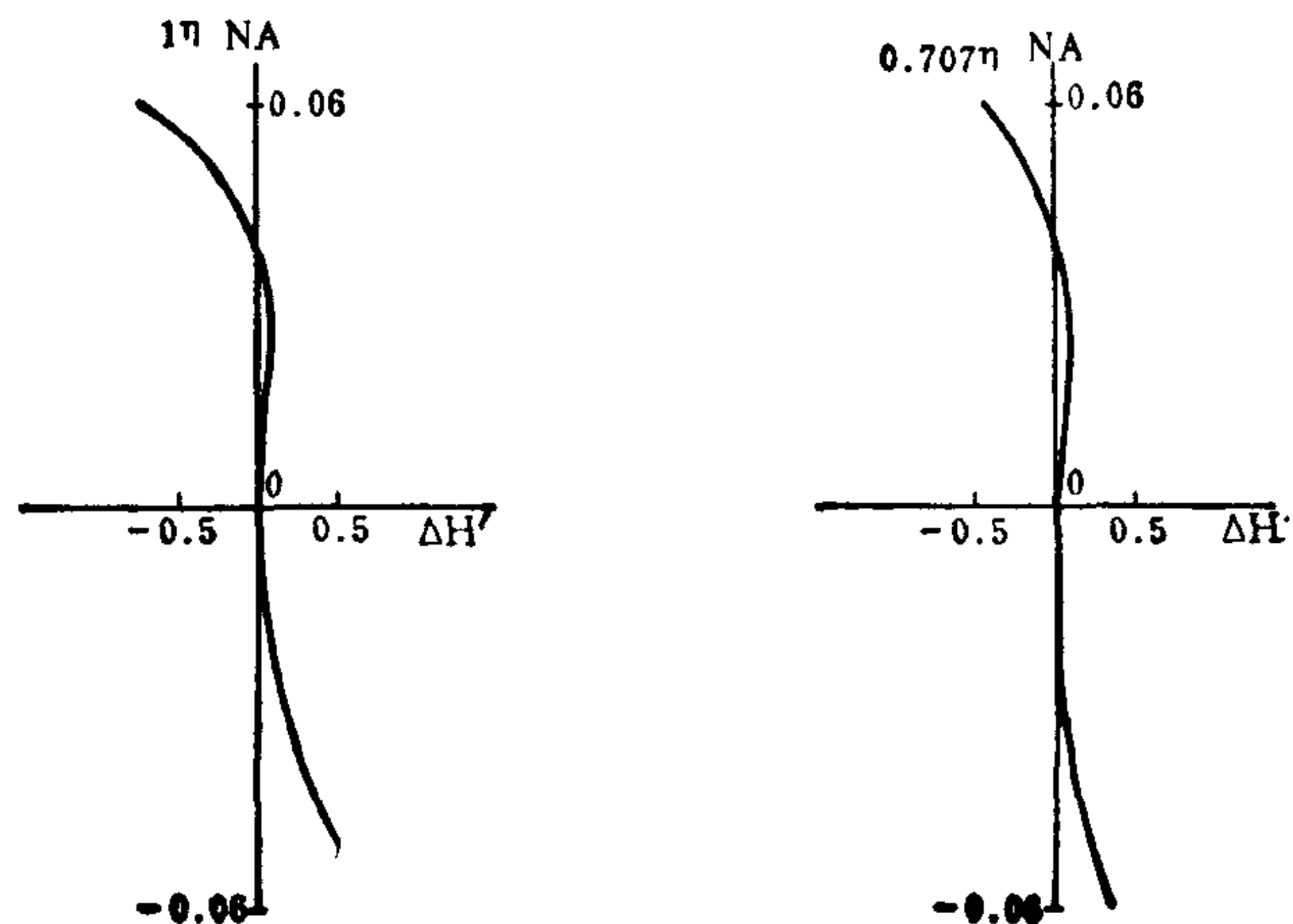
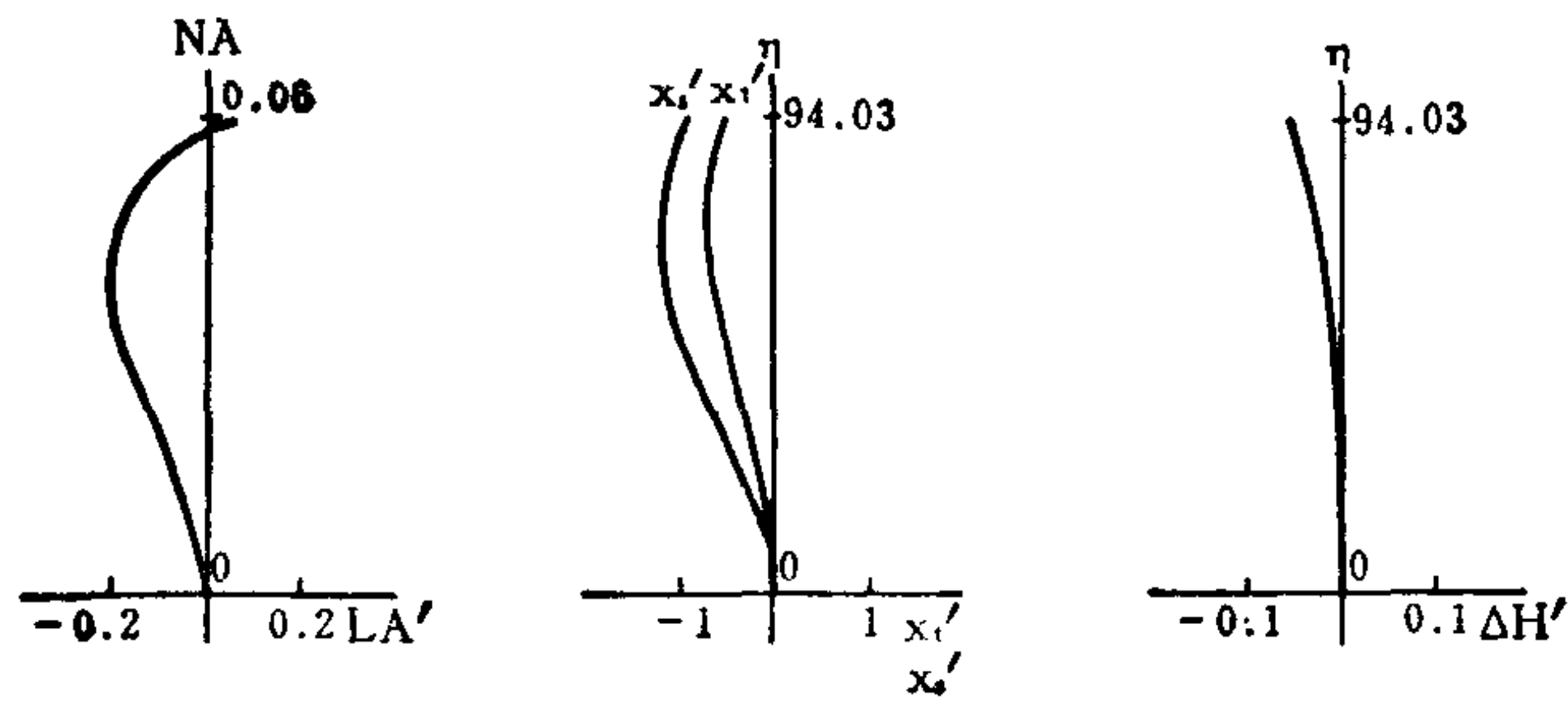

编号: 07-04-073

明亮的投影物镜

E.F.L = 100

B.F.L = 150.2

NA = 0.06

$\eta = 94.45$

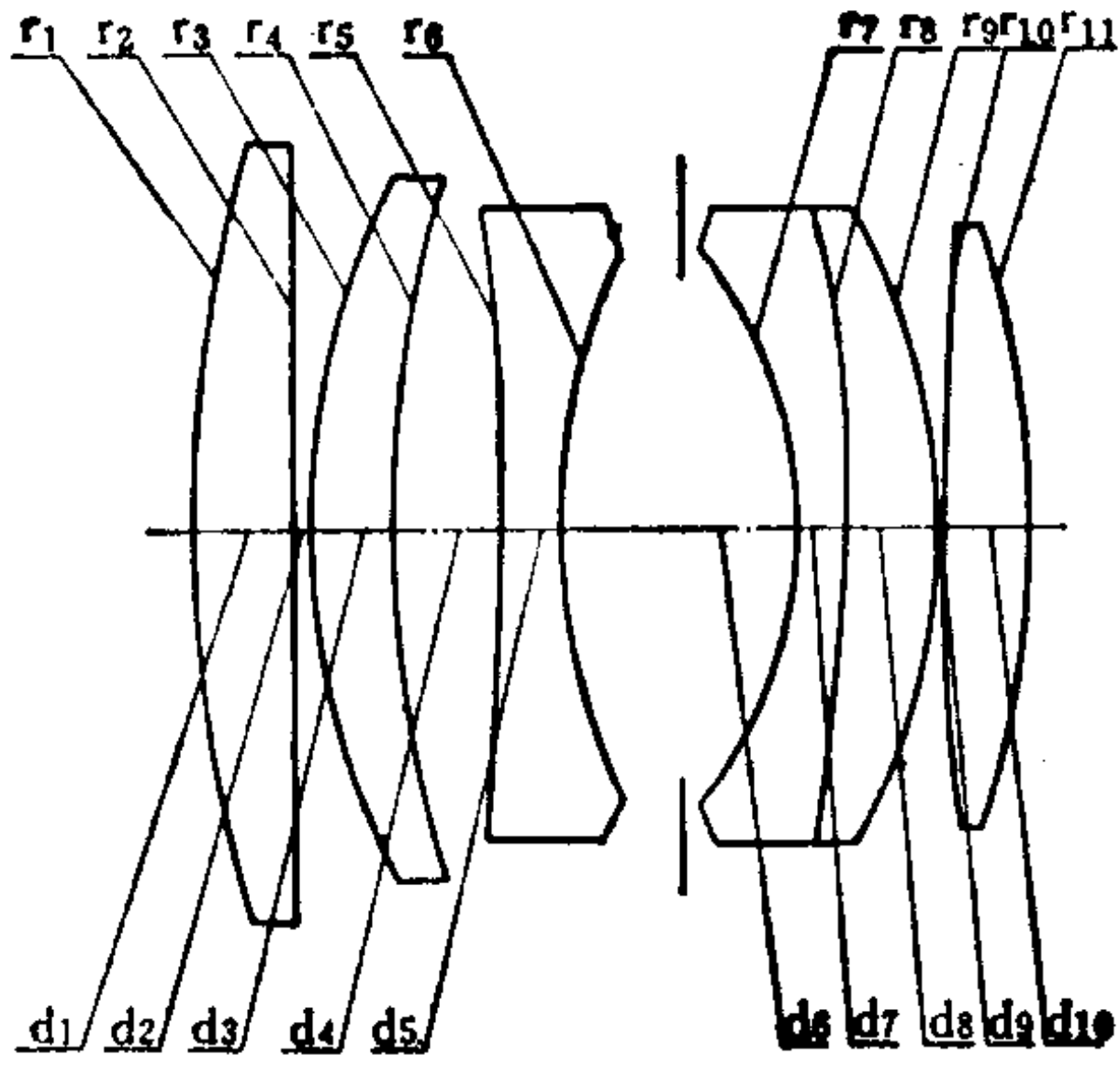

序号	r	d	n	v	序号	r	d	n	v
1	78.2149	6.166	1.63854	55.38	7	-25.2312	3.293	1.59270	35.29
2	∞	0.524			8	-96.8018	4.933	1.67790	55.33
3	44.2423	5.296	1.63854	55.38	9	-36.0128	0.197		
4	89.4897	5.962			10	1453.4430	4.933	1.63854	55.38
5	-578.8580	3.121	1.59270	35.29	11	-49.6763			
6	34.1778	13.244*							

13.244* = 6.622 + 6.622

	ΣS_1	ΣS_2	ΣS_3	ΣS_4	ΣS_5	HI	QP(1 η)
	-0.00945	-0.00069	0.00484	-0.06053	0.16781	63	-2%
NA或 η %	LA'	$\Delta H'$	x'_i	x'_o	$x'_i - x'_o$	K'_{f1}	$K'_{f0.7}$
100	-0.0182	-1.297	-0.691	-0.438	-0.253	-0.1045	-0.0053
70	-0.1572	-0.434	-0.880	-1.082	0.202	-0.0009	0.0079

注: 以上象差值是在 $l = -214.398$ 、 $\eta = 94.45$ 、 $M = -0.667^*$ 及 $F/3.3$ (NA = 0.06) 时计算的。

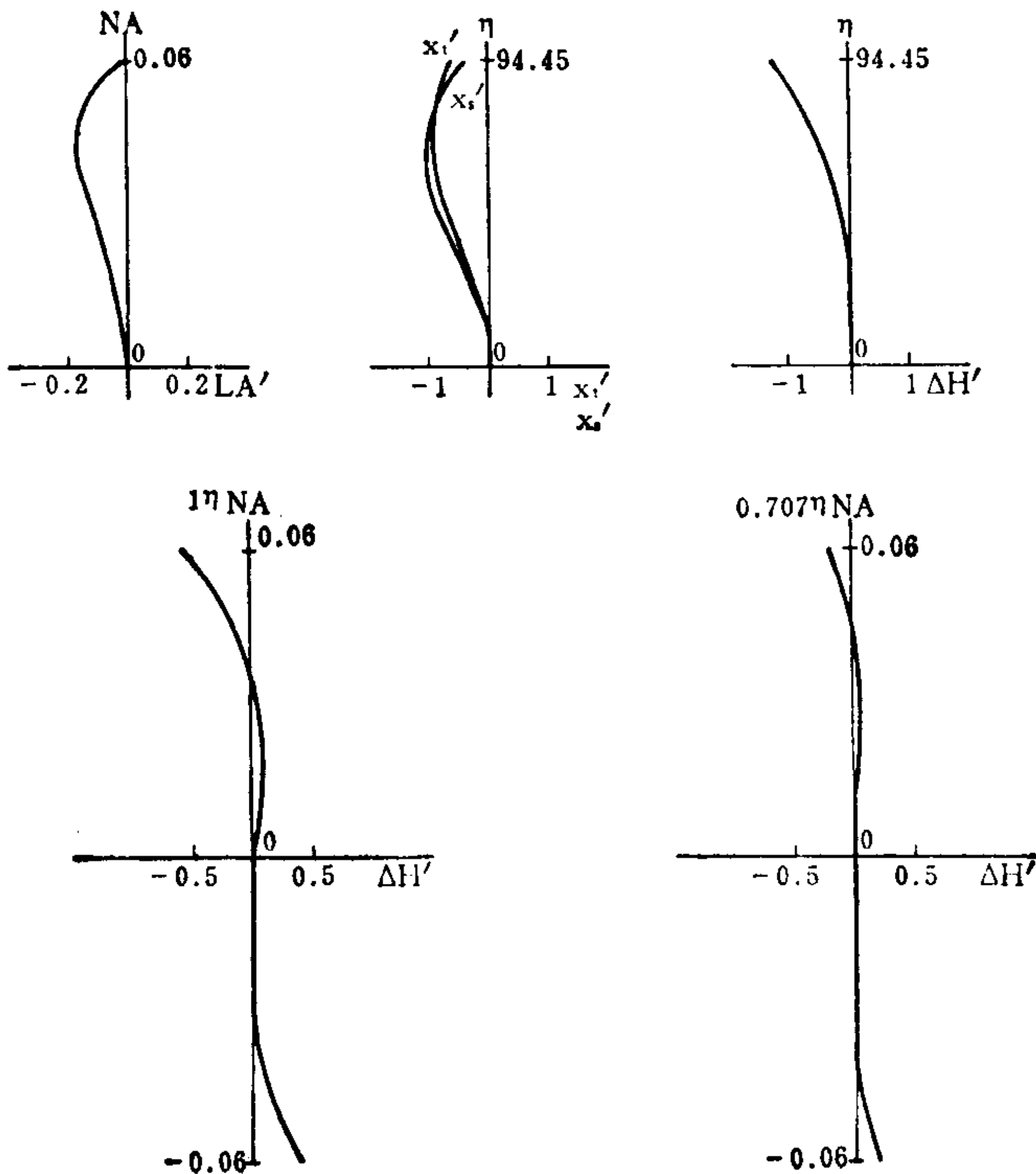

编号: 07-04-074

投 影 物 镜

E.F.L=99.95

B.F.L=55.20

FNo.=2.8

F.A.=±15°

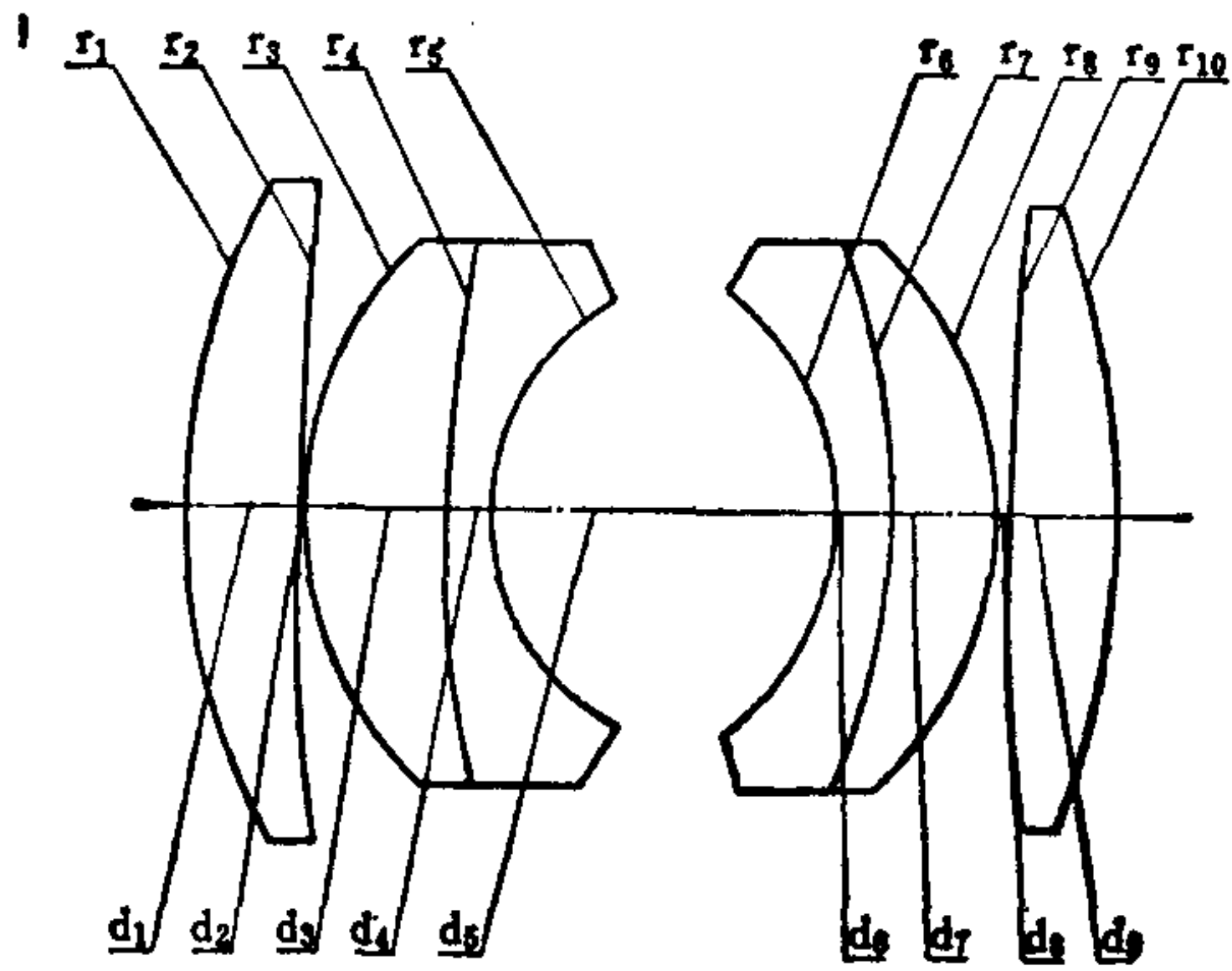

序号	r	d	n	v	序号	r	d	n	v
1	62.044	8.750	1.6385	55.4	6	-23.891	3.750	1.5920	35.3
2	202.730	0.625			7	-91.430	9.375	1.6400	60.3
3	32.553	12.500	1.6780	55.3	8	-31.498	0.625		
4	121.361	3.750	1.6400	34.6	9	569.833	8.750	1.6520	58.7
5	20.575	28.750*			10	-69.590			

28.750* = 14.375 + 14.375

	ΣS_1	ΣS_2	ΣS_3	ΣS_4	ΣS_5	HI	QP(1 ω)
	-0.00969	-0.01246	-0.00503	-0.01421	0.04948	26.7	0.5%
h 或 ω %	LA'	$\Delta H'$	x'_t	x'_s	$x'_t - x'_s$	K'_{T1}	$K'_{T0.7}$
100	0.1373	0.1458	-0.719	-0.212	-0.507	-0.0773	-0.0456
70	-0.0094	0.0505	-0.303	-0.134	-0.169	-0.0571	-0.0334

注: 以上象差值是按 $l = -\infty$ 计算的。

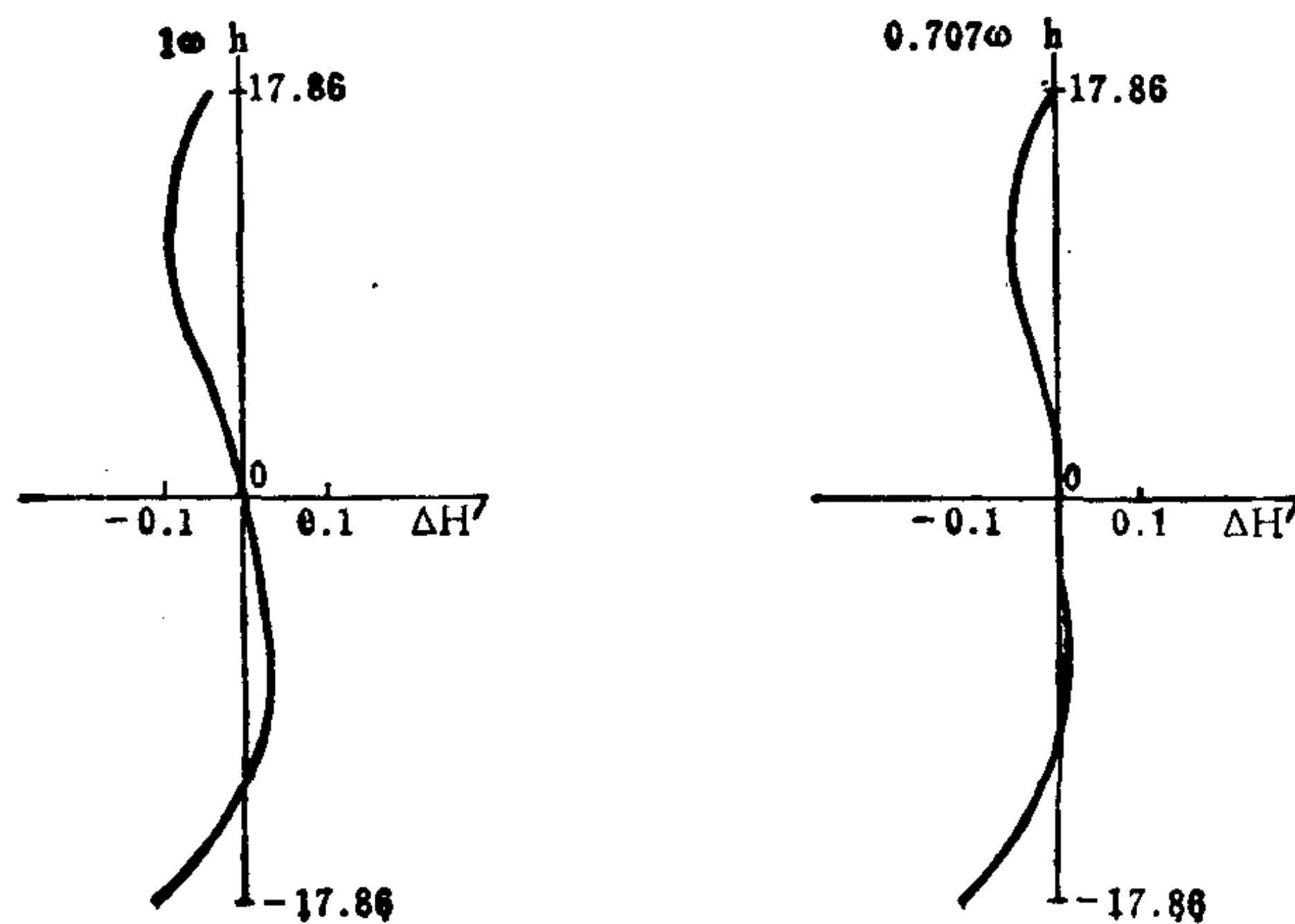
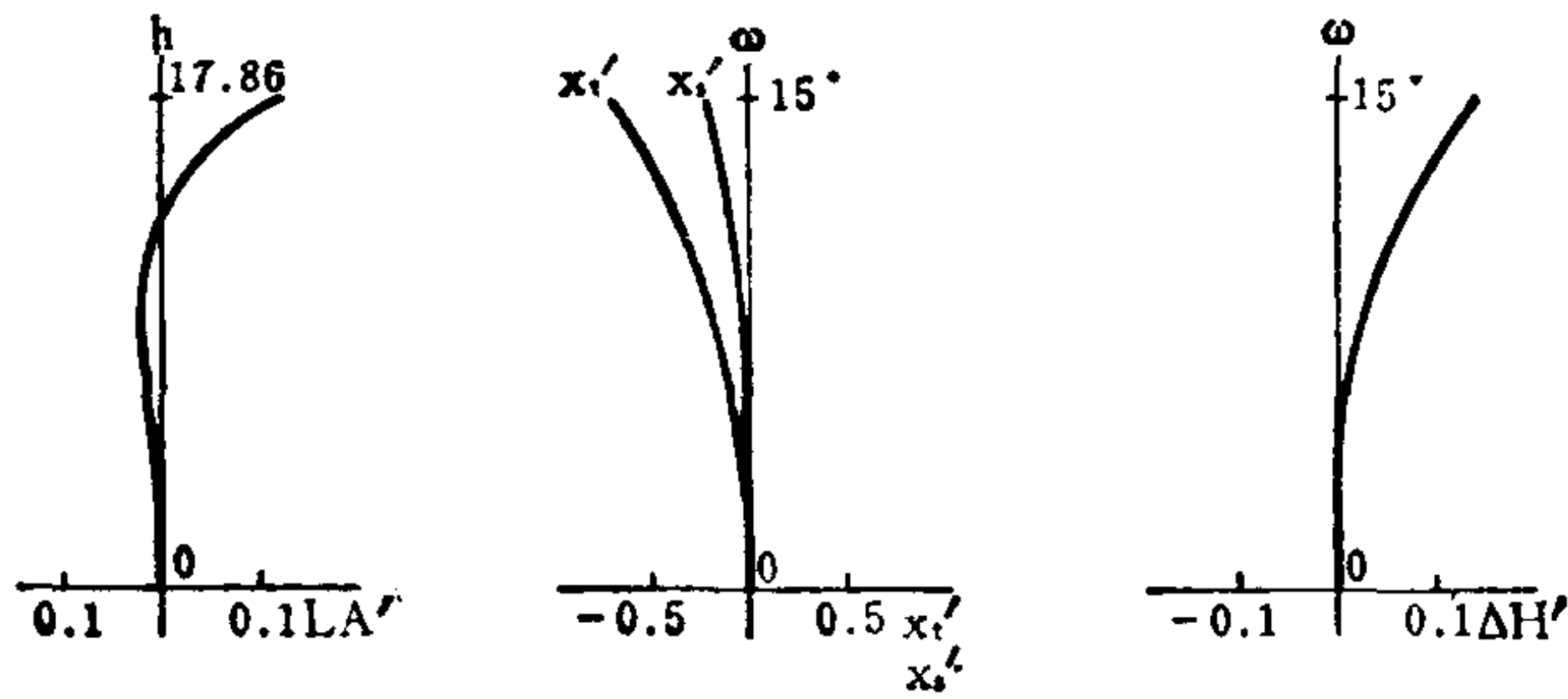

编号: 07-04-075

高倍率投影物镜

E.F.L=10

B.F.L=3.76

FNo.=2

F.A.=±14.7°**

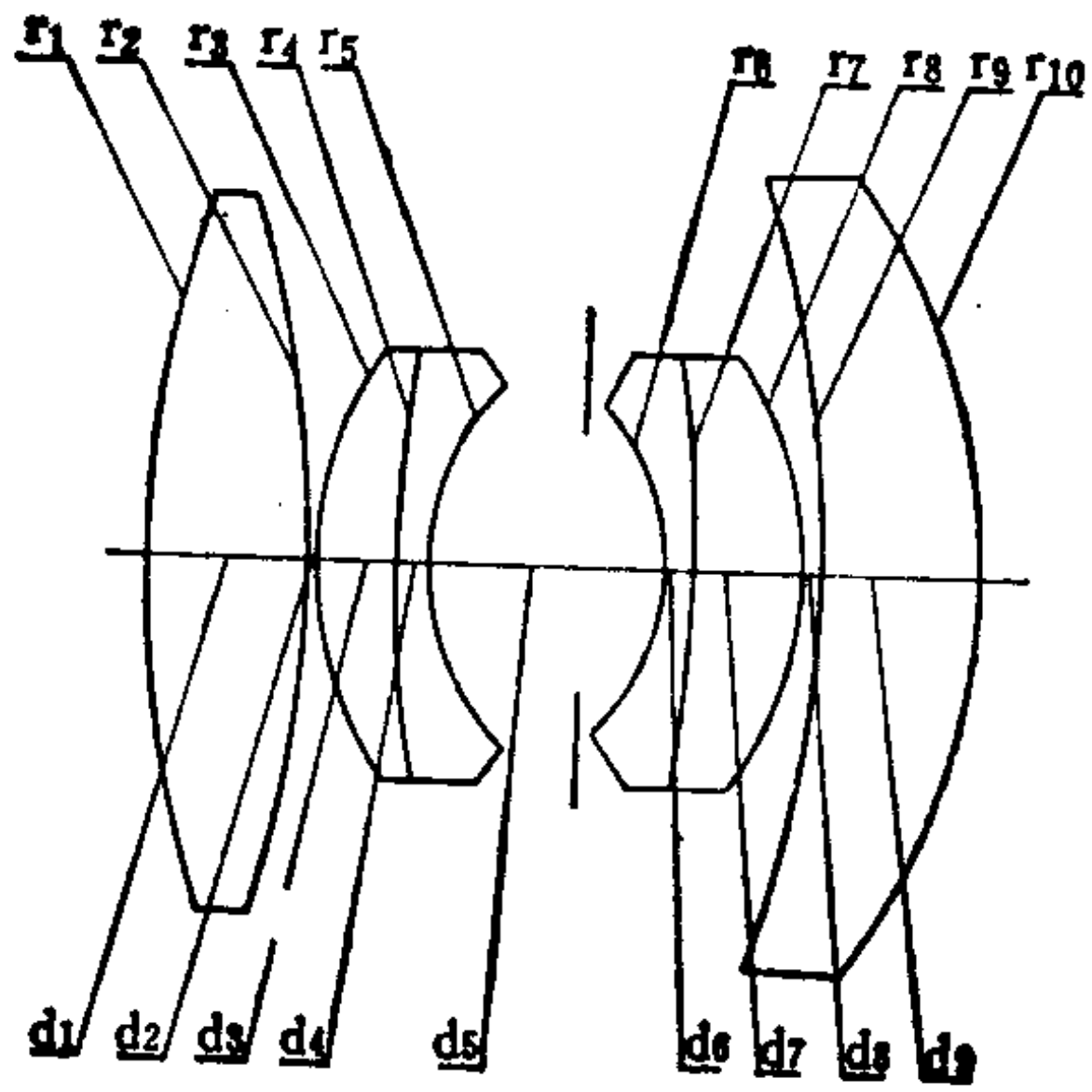

序号	r	d	n	v	序号	r	d	n	v
1	14.18	1.92	1.787	50.2	6	-2.70	0.40	1.762	26.6
2	-13.51	0.07			7	-14.02	1.29	1.804	46.7
3	4.34	0.95	1.658	57.3	8	-3.93	0.03		
4	17.07	0.39	1.593	35.3	9	-18.43	1.94	1.804	46.7
5	3.11	2.70*			10	-7.27			

2.70* = 1.35 + 1.35

	ΣS_1	ΣS_2	ΣS_3	ΣS_4	ΣS_5	HI	QP(1 ω)
	-0.0472	0.0761	-0.1184	-0.0093	0.1357	2.6	13.8%
h 或 ω %	LA'	$\Delta H'$	x'_t	x'_s	$x'_t - x'_s$	K'_{T1}	$K'_{T0.7}$
100	-0.437	0.361	-4.422	-1.313	-3.109	2.5650	0.8134
70	-0.199	0.093	-1.625	-0.532	-1.093	0.7974	0.3041

注: 以上象差值是按 $l = -\infty$ 计算的。

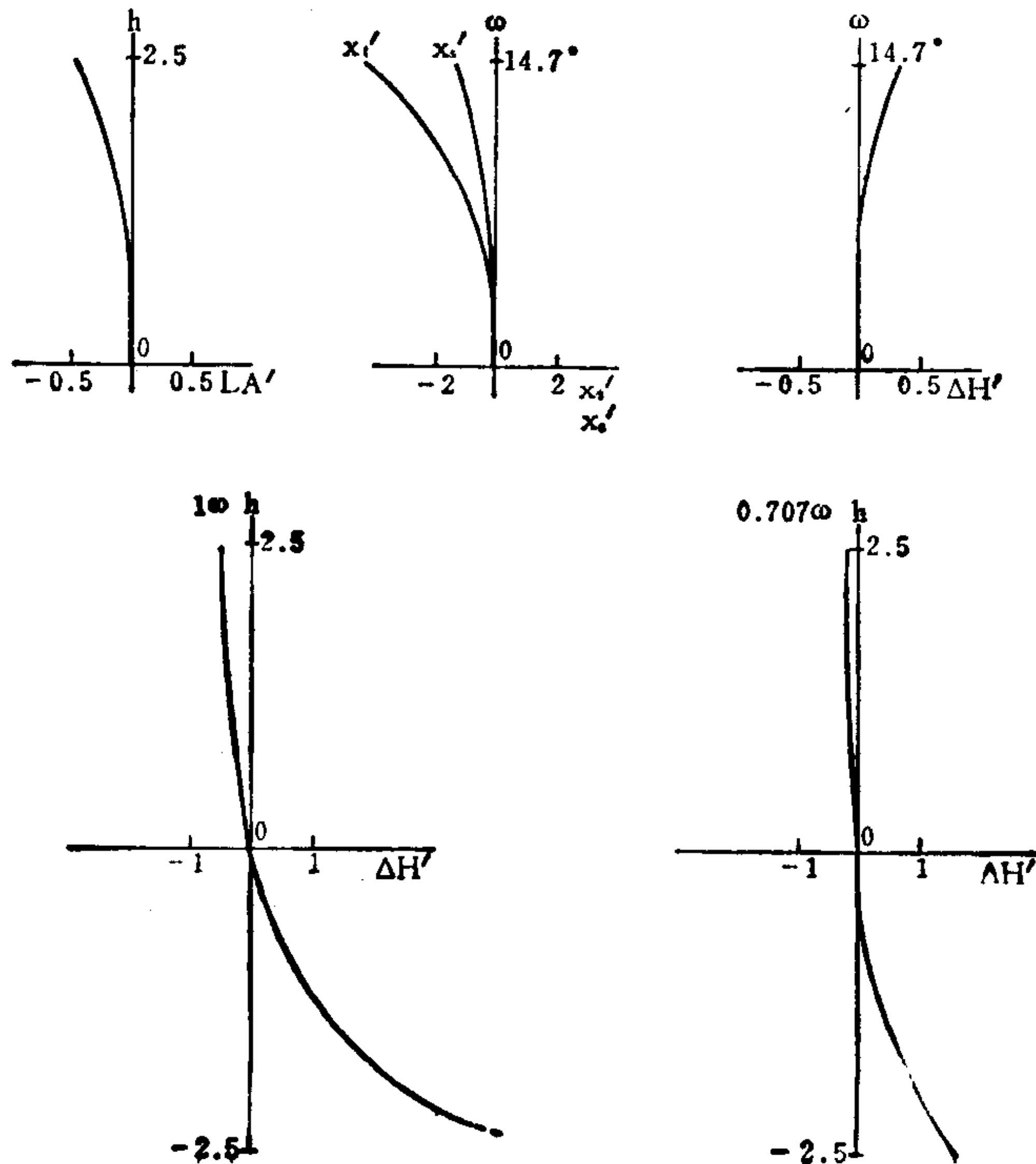

编号: 07-04-076

超高倍率投影物镜

E.F.L=1

B.F.L=0

FNo.=3.5**

F.A.=±17.2°**

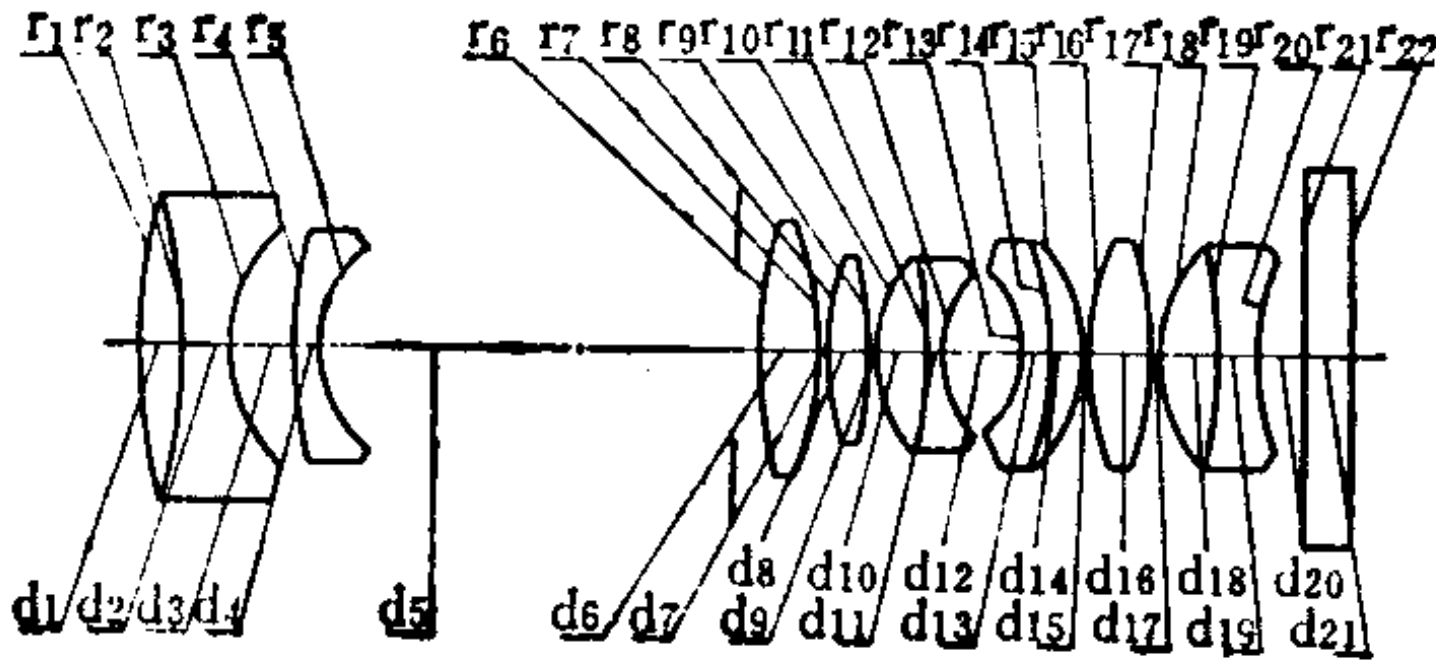

序号	r	d	n	v	序号	r	d	n	v
1	11.18077	0.44663	1.80523	25.43	12	1.71570	0.96731		
2	-12.48247	0.74052	1.43387	95.15	13	-1.80295	0.37026	1.73539	40.92
3	2.45901	0.84698			14	-5.90960	0.48134	1.60710	59.00
4	31.70140	0.33786	1.51148	51.00	15	-2.40601	0.04397		
5	1.88371	6.44488*			16	4.68590	0.80995	1.60710	59.00
6	11.40778	0.73127	1.51724	52.41	17	-4.90551	0.01388		
7	-5.02030	0.02083			18	2.19357	0.76829	1.60710	59.00
8	3.50199	0.54382	1.43387	95.15	19	-13.30191	0.69887	1.61683	36.50
9	-15.86829	0.02083			20	3.79565	0.53720		
10	2.04269	0.65027	1.43387	95.15	21	∞	0.73474	1.51633	63.98
11	-22.63946	0.21984	1.74947	35.24	22	∞			

6.44488* = 6.31760 + 0.12728

	ΣS ₁	ΣS ₂	ΣS ₃	ΣS ₄	ΣS ₅	HI	QP(1ω)
	-0.0000046	-0.0000018	0.0000191	-0.0000254	-0.0017143	0.3	-1.8%
h 或 ω %	LA'	ΔH'	x _t '	x _s '	x _t ' - x _s '	K _{T1}	K _{T0.7}
100	-0.000075	-0.00563	-0.00052	-0.00020	-0.00032	-0.000010	-0.000007
70	-0.000047	-0.00211	0.00011	-0.00009	0.00020	-0.000011	-0.000007

注: 1. 以上象差值是按 $l = -\infty$ 计算的。
2. 其NA = 0.38, 投影倍率M = 200*。

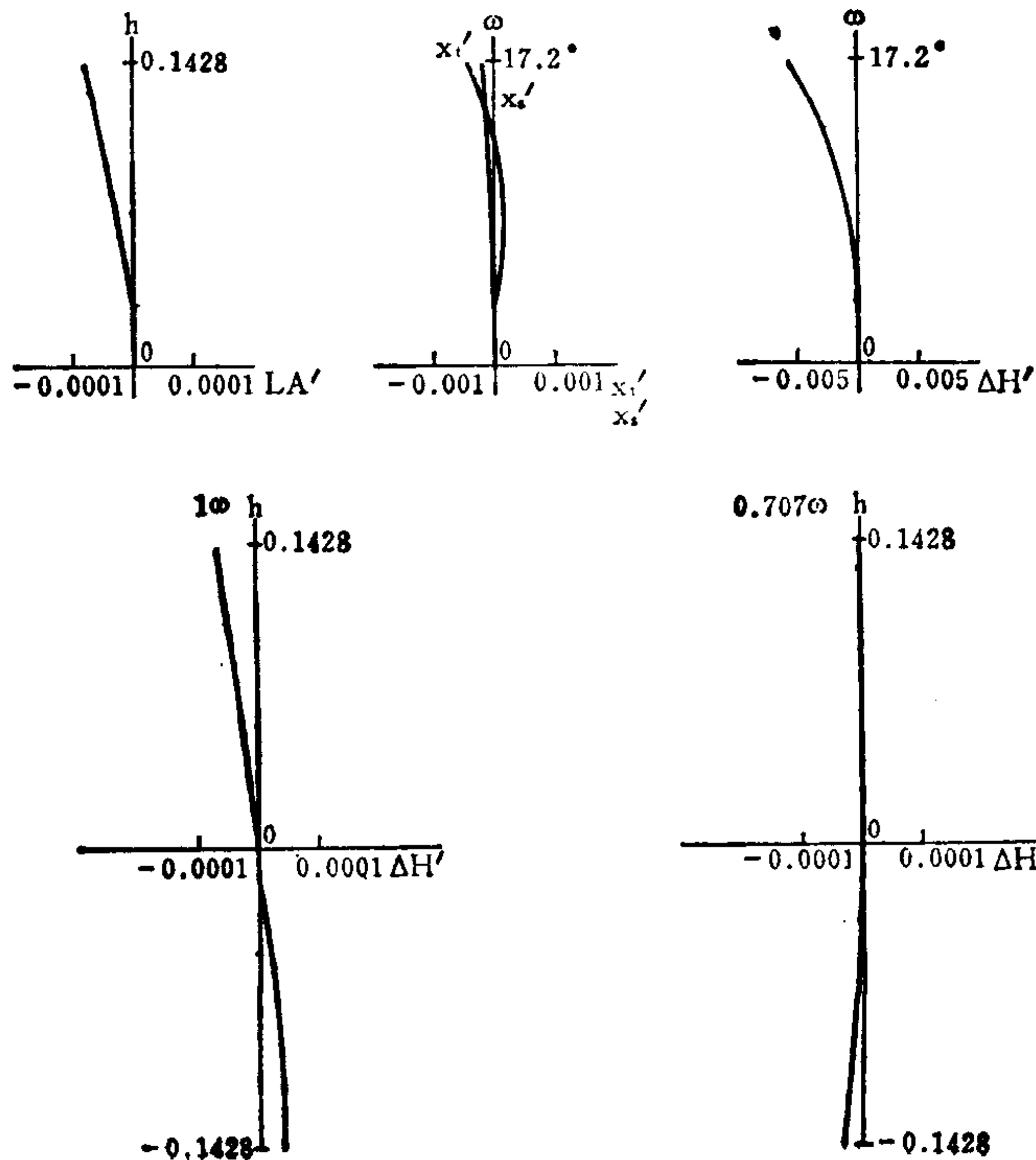

编号: 07-04-077

远 摄 物 镜

E.F.L = 100

B.F.L = 44.69

FNo. = 3.5

F.A. = ± 9.2°

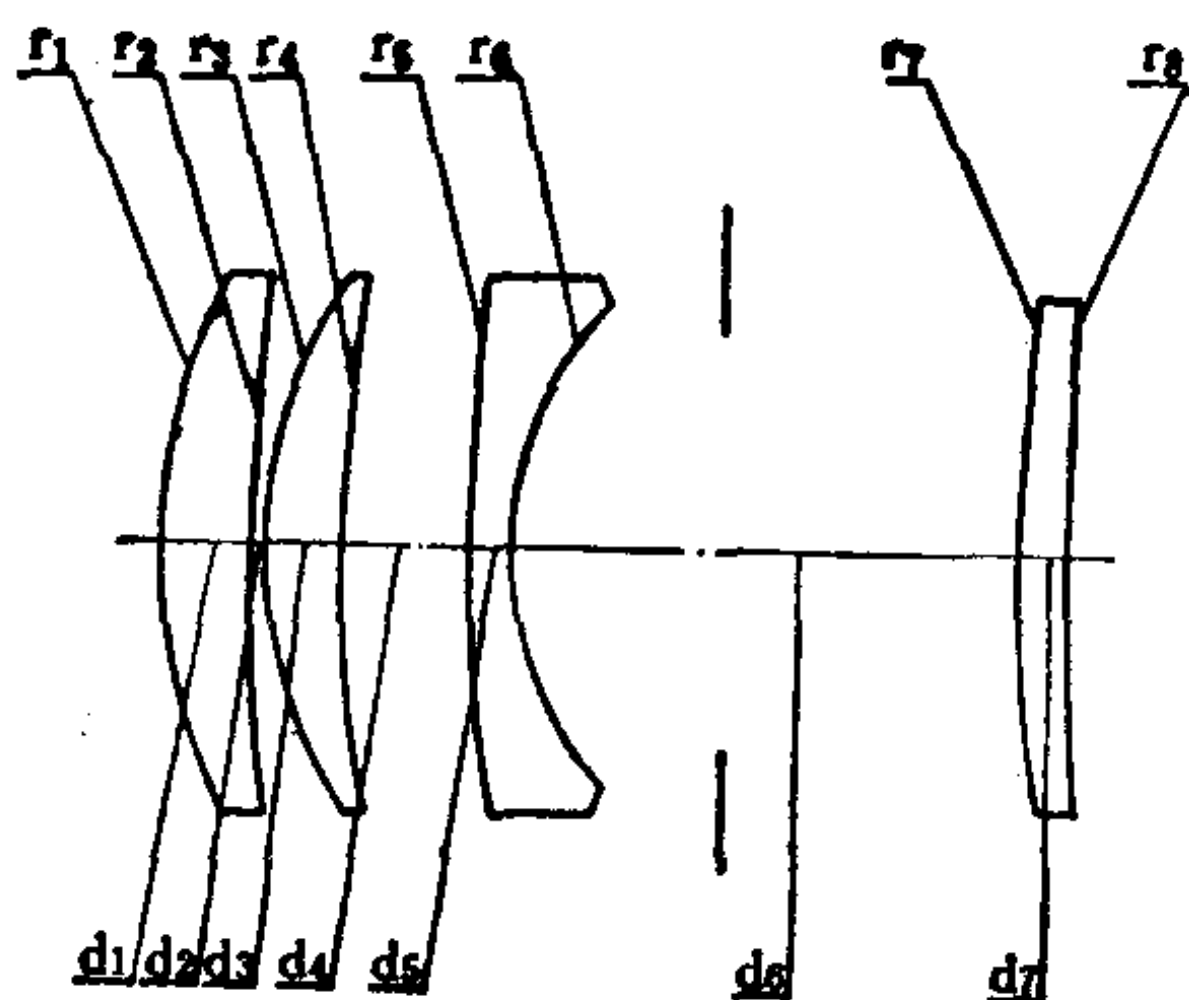

序号	r	d	n	v	序号	r	d	n	v
1	33.748	4.44	1.62041	60.3	5	277.147	1.94	1.71736	29.5
2	313.490	0.34			6	18.445	25.85*		
3	25.344	4.13	1.48749	70.1	7	85.929	2.55	1.78472	25.7
4	66.415	6.88			8	1192.200			

25.85* = 12.00 + 13.85

	ΣS_1	ΣS_2	ΣS_3	ΣS_4	ΣS_5	HI	QP(1 ω)
	-0.01503	0.00159	0.00286	-0.00899	0.05160	16.2	1.1%
h 或 ω %	LA'	$\Delta H'$	x'_t	x'_s	$x'_t - x'_s$	K'_{T1}	$K'_{T0.7}$
100	0.0173	0.187	-0.212	-0.159	-0.053	0.04346	0.02093
70	-0.0965	0.065	-0.044	-0.076	0.032	-0.02452	-0.00168

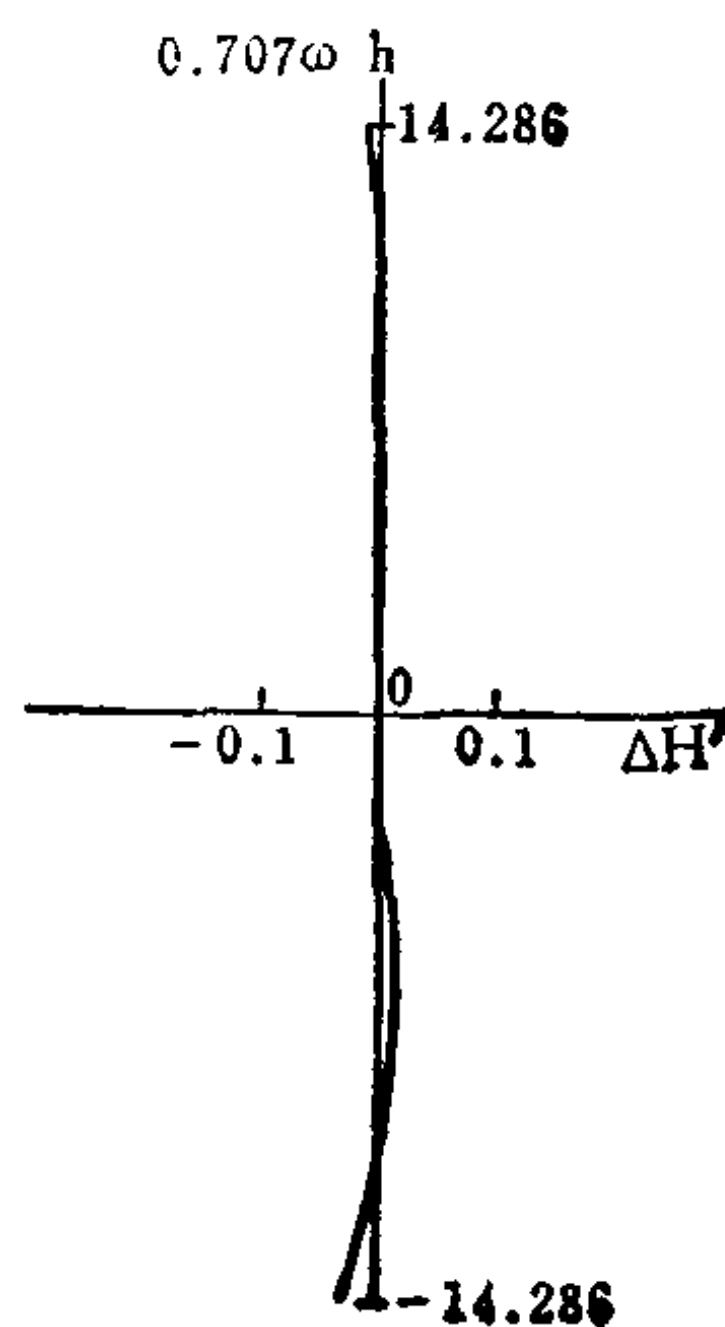
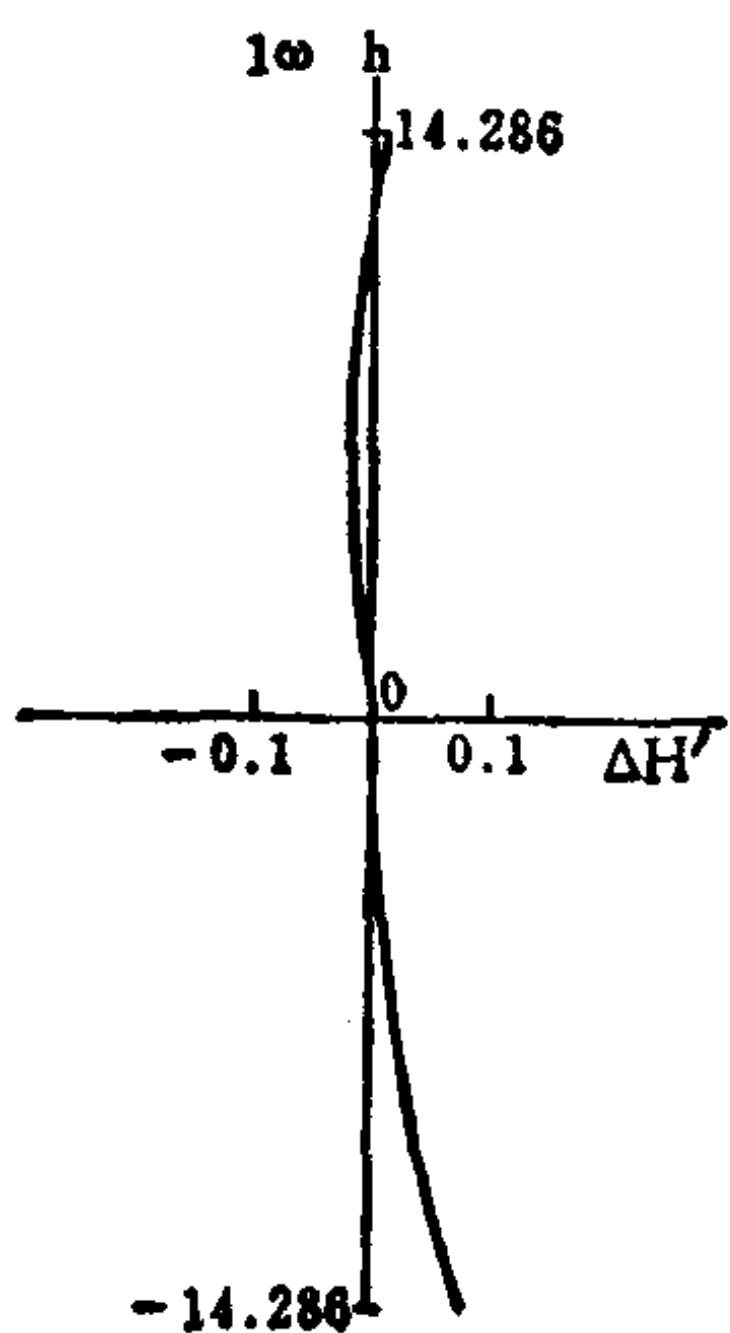
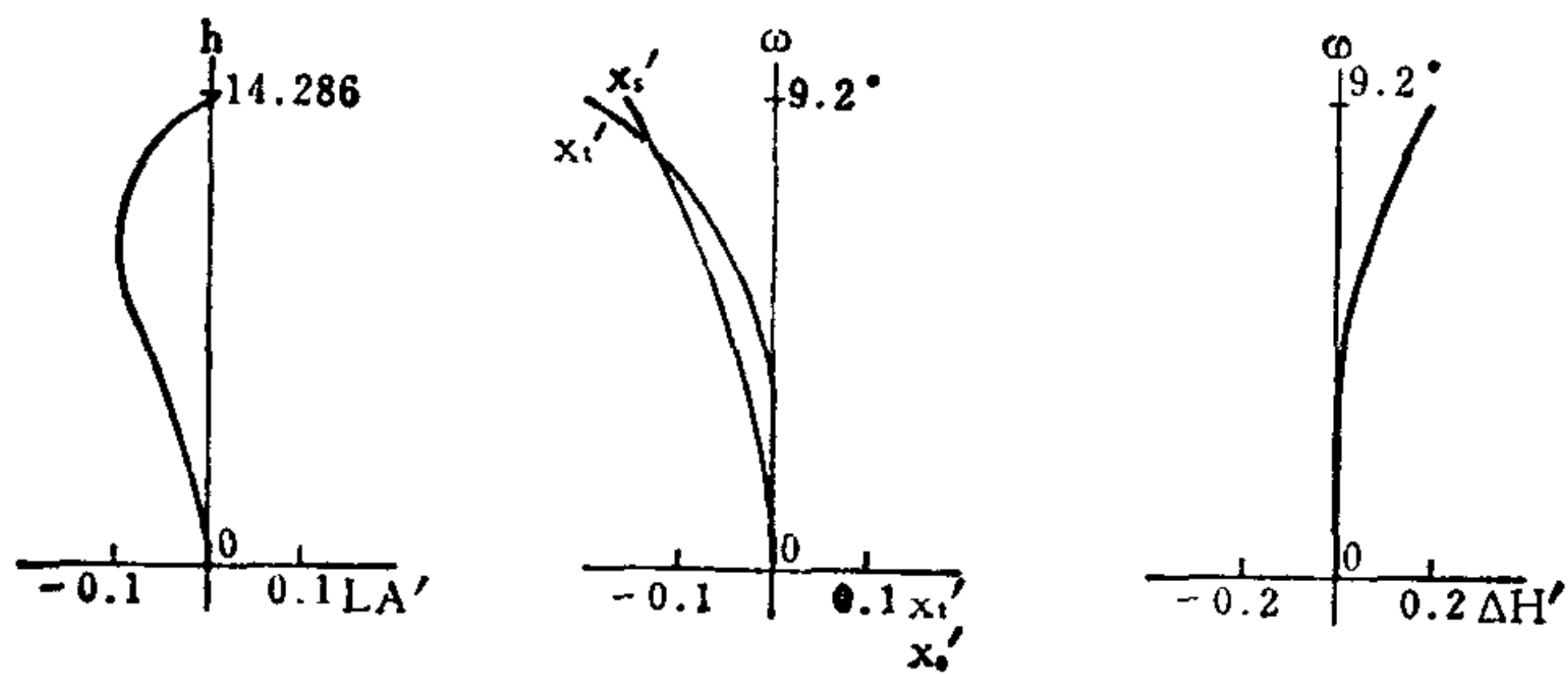

编号: 07-04-078

远 摄 物 镜

E.F.L = 100

B.F.L = 41.78

FNo. = 3.5

F.A. = ± 9.2°

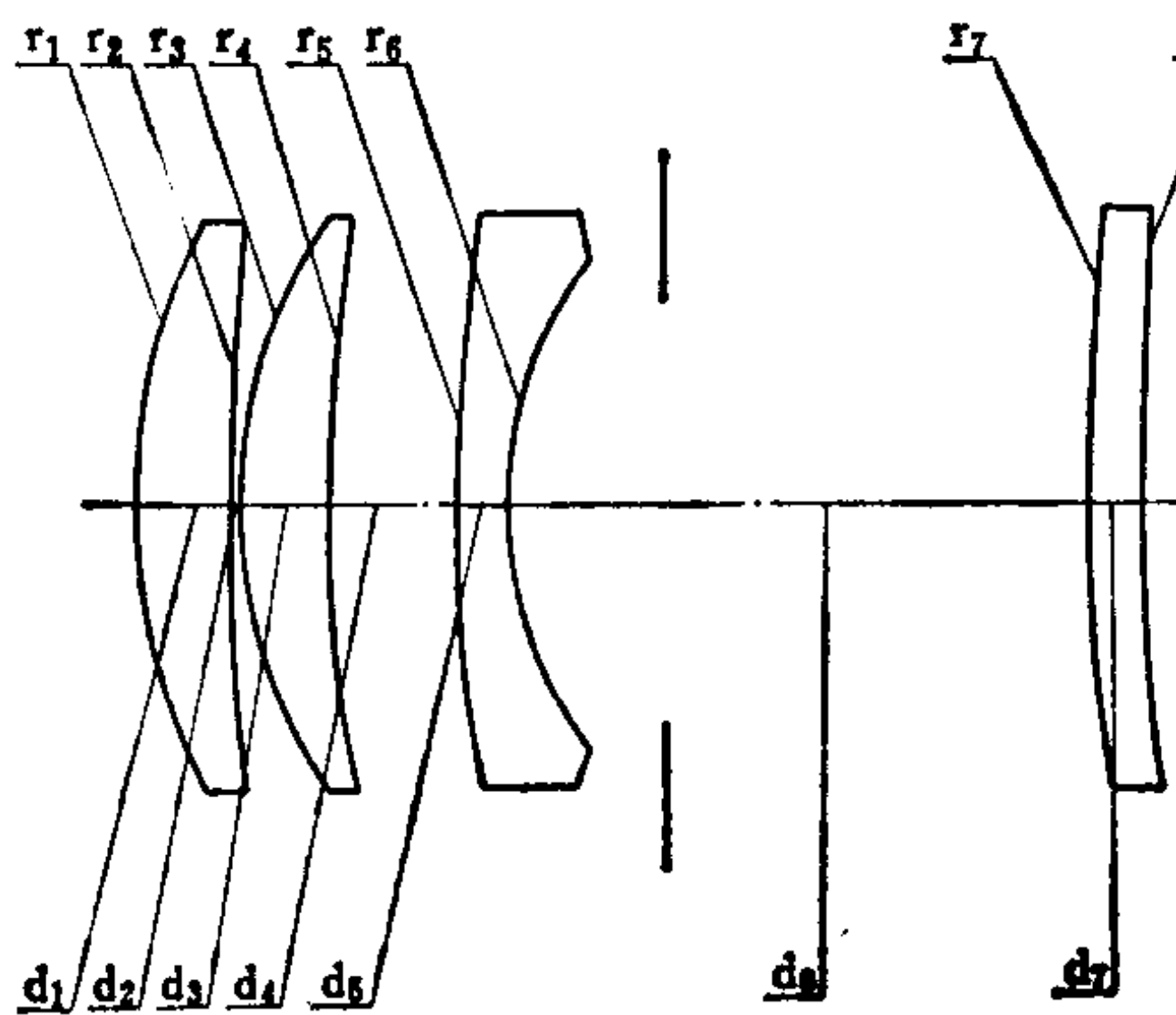

序号	r	d	n	v	序号	r	d	n	v
1	32.859	4.430	1.61800	63.4	5	289.480	2.230	1.74000	31.7
2	419.590	0.270			6	18.016	27.594*		
3	24.497	4.120	1.48749	70.2	7	84.561	3.000	1.78472	25.7
4	64.054	6.470			8	829.710			

27.594* = 12.000 + 15.594

	ΣS_1	ΣS_2	ΣS_3	ΣS_4	ΣS_5	HI	QP(1 ω)
	-0.01586	-0.00047	0.00501	-0.00787	0.05298	16.2	1.2%
h 或 ω %	LA'	$\Delta H'$	x'_t	x'_s	$x'_t - x'_s$	K'_{T1}	$K'_{T0.7}$
100	0.0055	0.197	-0.205	-0.111	-0.094	0.17134	0.05108
70	-0.1030	0.068	0.009	-0.043	0.052	0.00259	0.00139

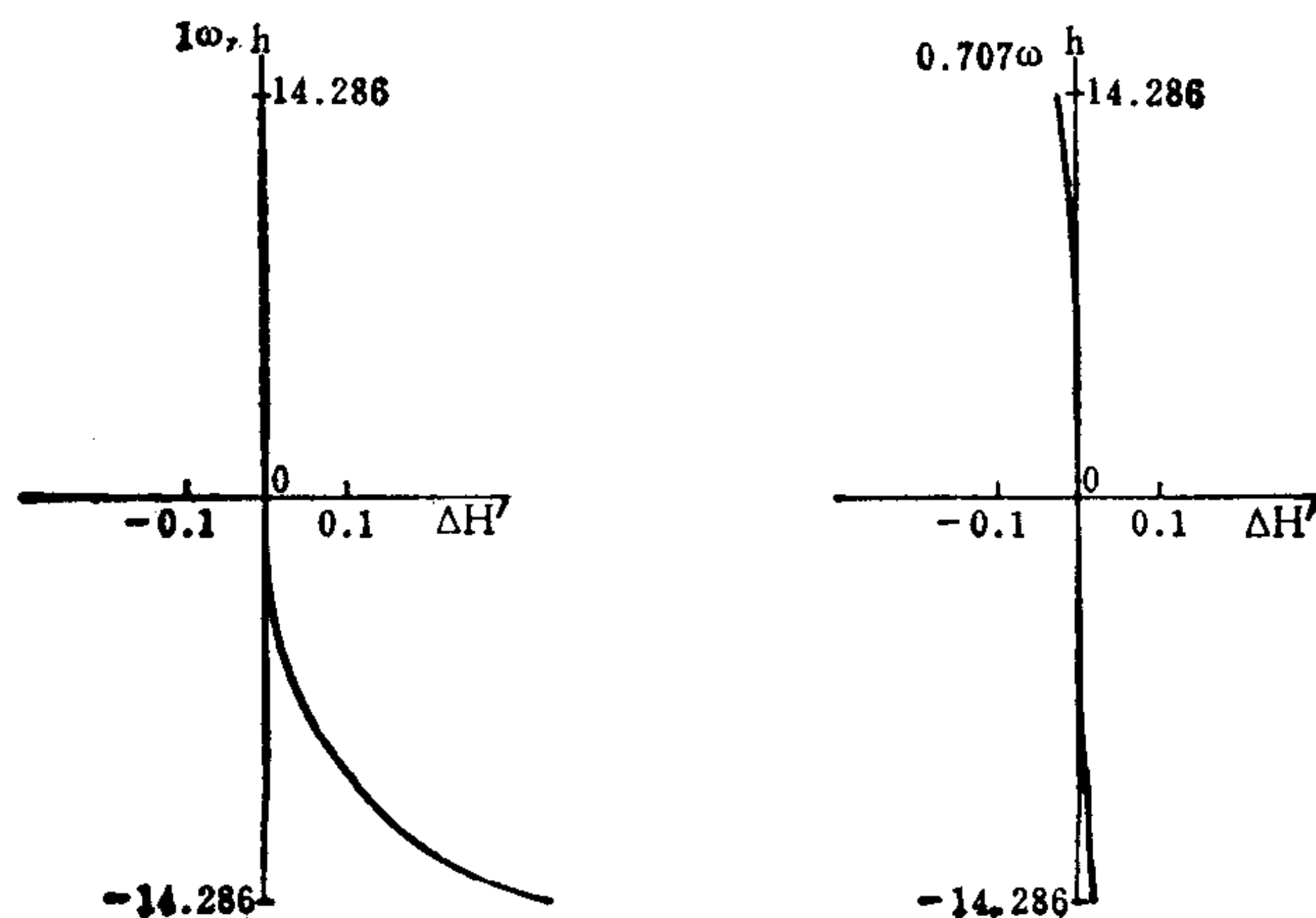
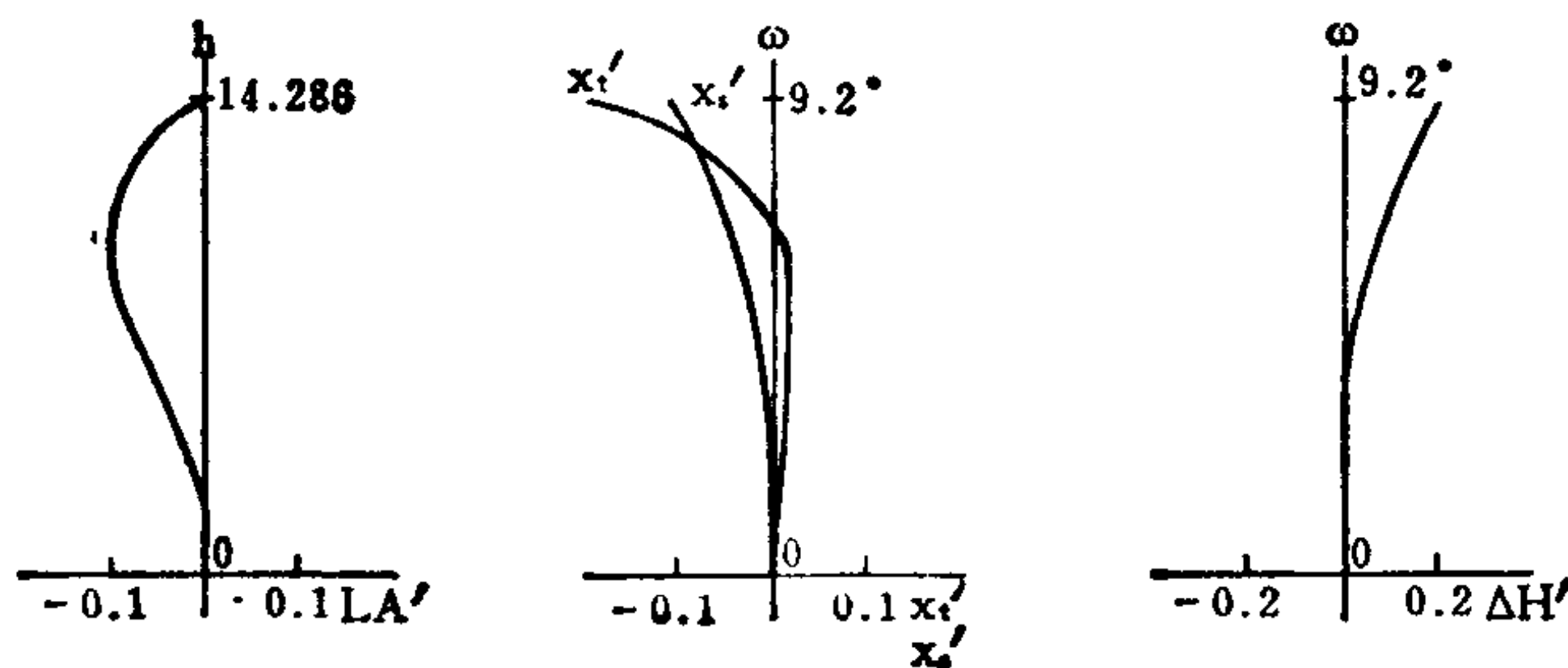

编号: 07-04-079

消色差物镜

E.F.L=300

B.F.L=77.18

FNo.=4.5

F.A.=±4.5°

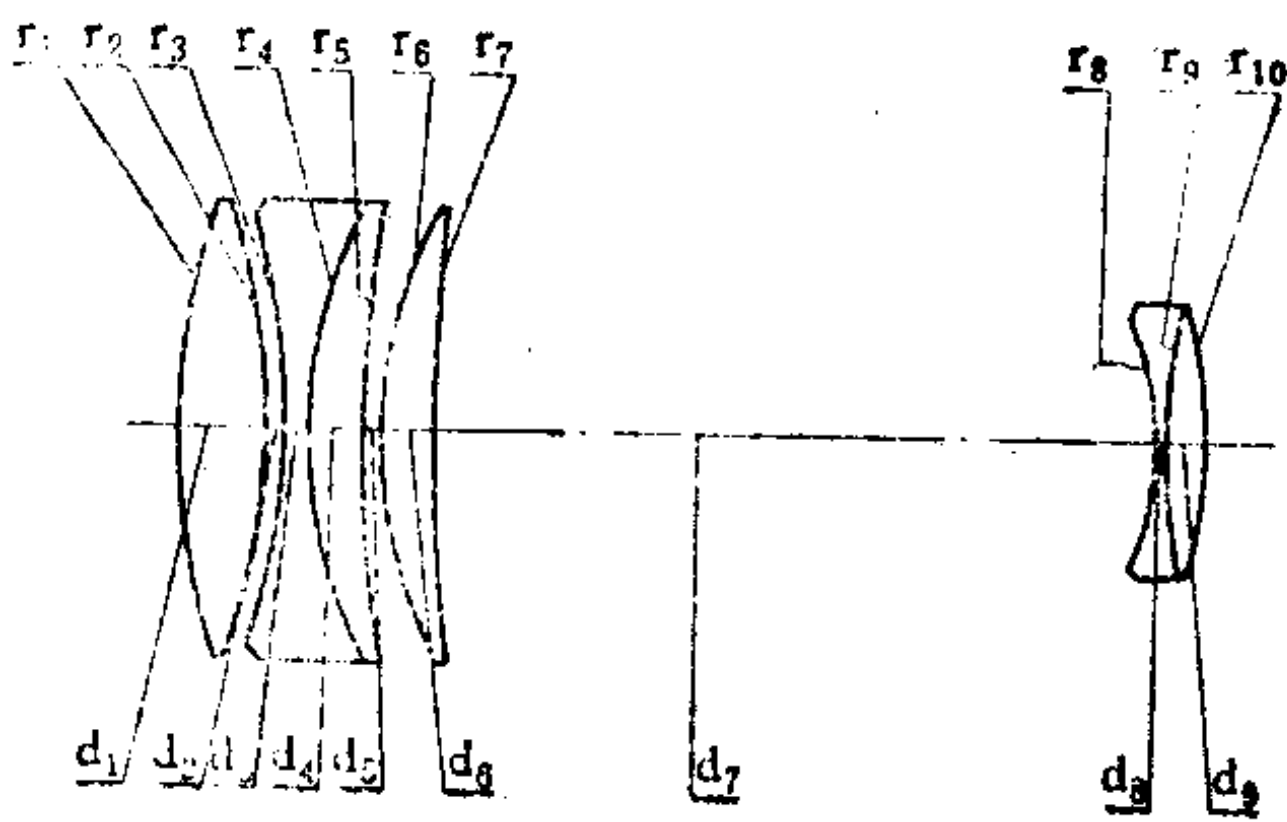

序号	r	d	n _d	v _d	序号	r	d	n _d	v _d
1	133.00	12.0	1.50032	81.9	6	82.75	7.7	1.50032	81.9
2	-140.00	4.0			7	322.40	115.0*		
3	-128.00	3.0	1.61266	44.3	8	-42.56	1.0	1.62041	60.3
4	70.00	9.0	1.63930	45.0	9	220.00	3.5	1.62004	36.3
5	316.30	1.0			10	-91.10			

115.0* = 57.5 + 57.5

	ΣS ₁	ΣS ₂	ΣS ₃	ΣS ₄	ΣS ₅	HI	QP(1ω)
	-0.00594	0.00039	-0.00513	0.00661	0.05260	23.6	1%
h 或 ω %	LA'	ΔH'	x _i '	x _s '	x _i ' - x _s '	K _{T1}	K _{T0.7}
100	0.0425	0.241	-0.314	0.062	-0.376	0.00988	-0.00909
70	-0.0484	0.084	-0.166	0.030	-0.196	-0.00538	-0.00508

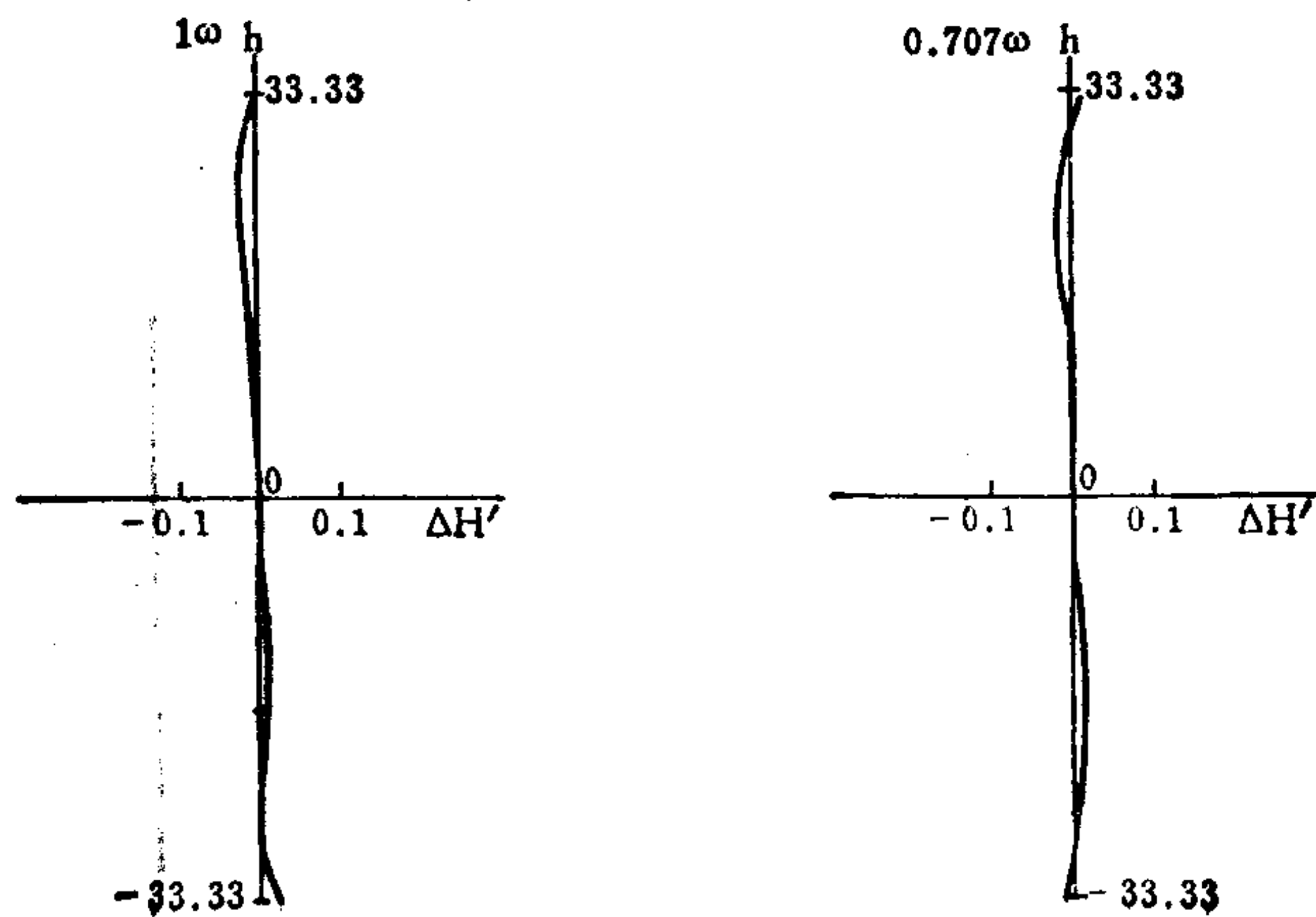
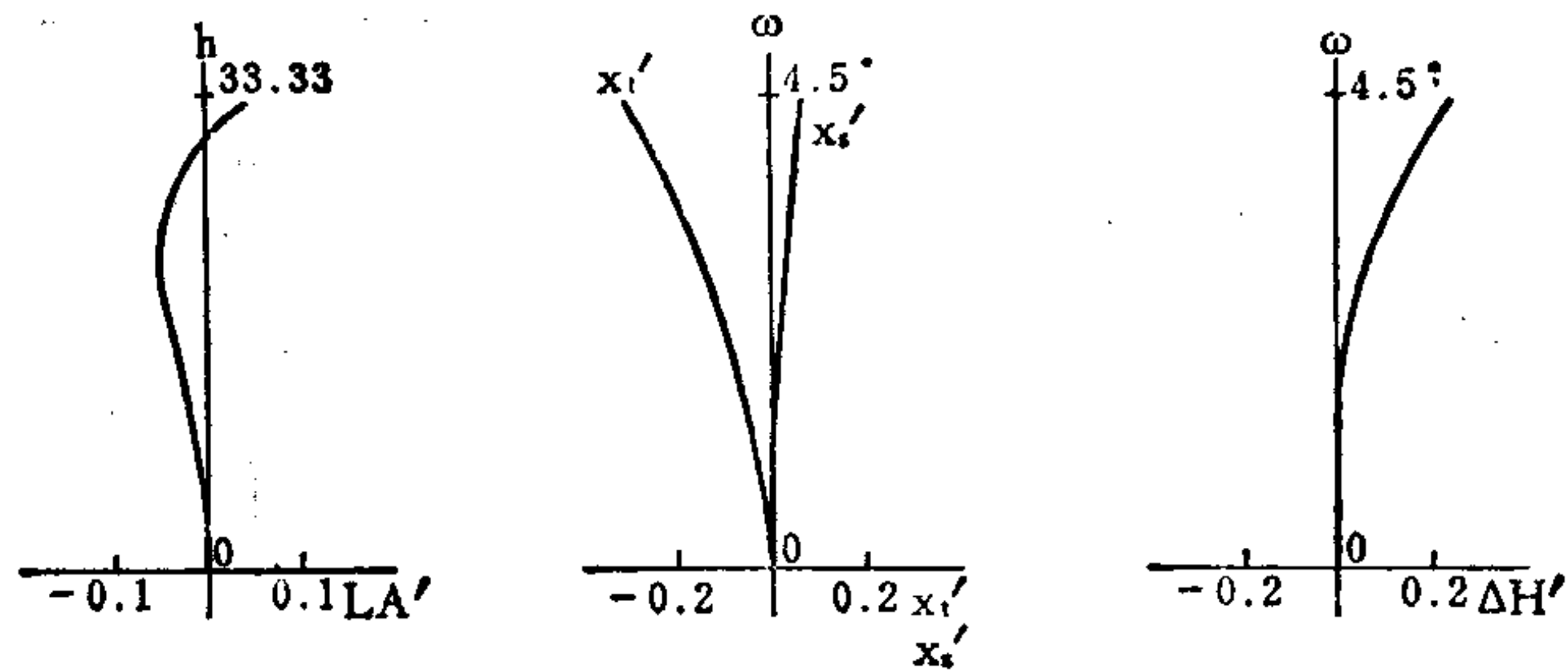

编号: 07-04-080

消色差物镜

E.F.L=600

B.F.L=248.12

FNo.=5.6

F.A.=±4°

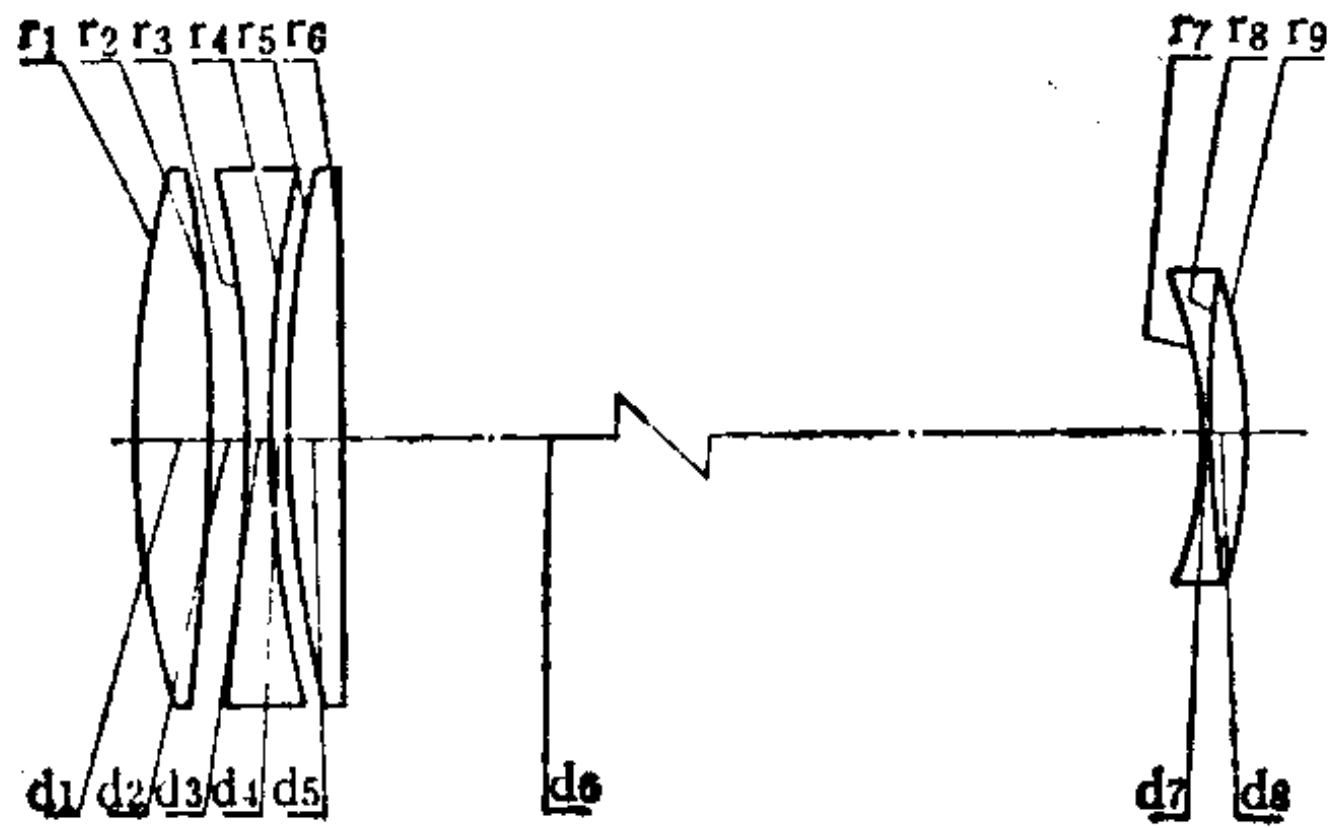

序号	r	d	nd	vd	序号	r	d	nd	vd
1	206.0	15.0	1.50032	81.9	6	∞	254.0*		
2	-312.1	6.0			7	-93.0	1.5	1.52682	51.1
3	-299.0	6.0	1.74400	44.9	8	200.0	6.0	1.62374	47.0
4	334.9	1.5			9	-146.9			
5	213.4	10.0	1.56965	49.5					

254.0* = 127.0 + 127.0

	ΣS ₁	ΣS ₂	ΣS ₃	ΣS ₄	ΣS ₅	HI	QP(1ω)
	-0.00850	-0.00099	0.00159	-0.01099	0.00835	41.9	0.1%
h 或 ω %	LA'	ΔH'	x' _i	x' _s	x' _i - x' _s	K' _{T1}	K' _{T0.7}
100	0.0935	0.045	-0.437	-0.597	0.160	0.00147	-0.01205
70	-0.1155	0.016	-0.206	-0.297	0.091	0.00130	-0.00614

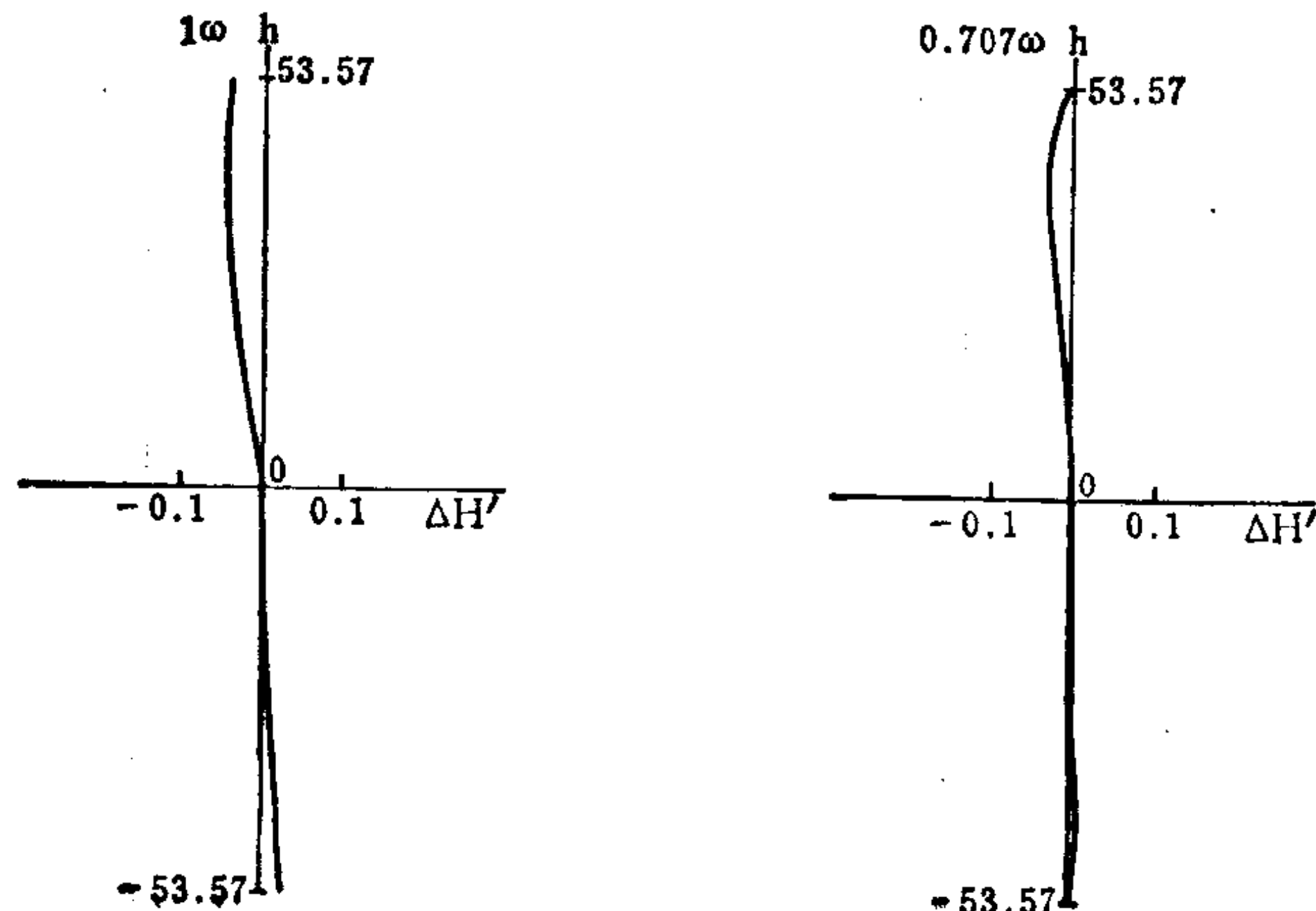
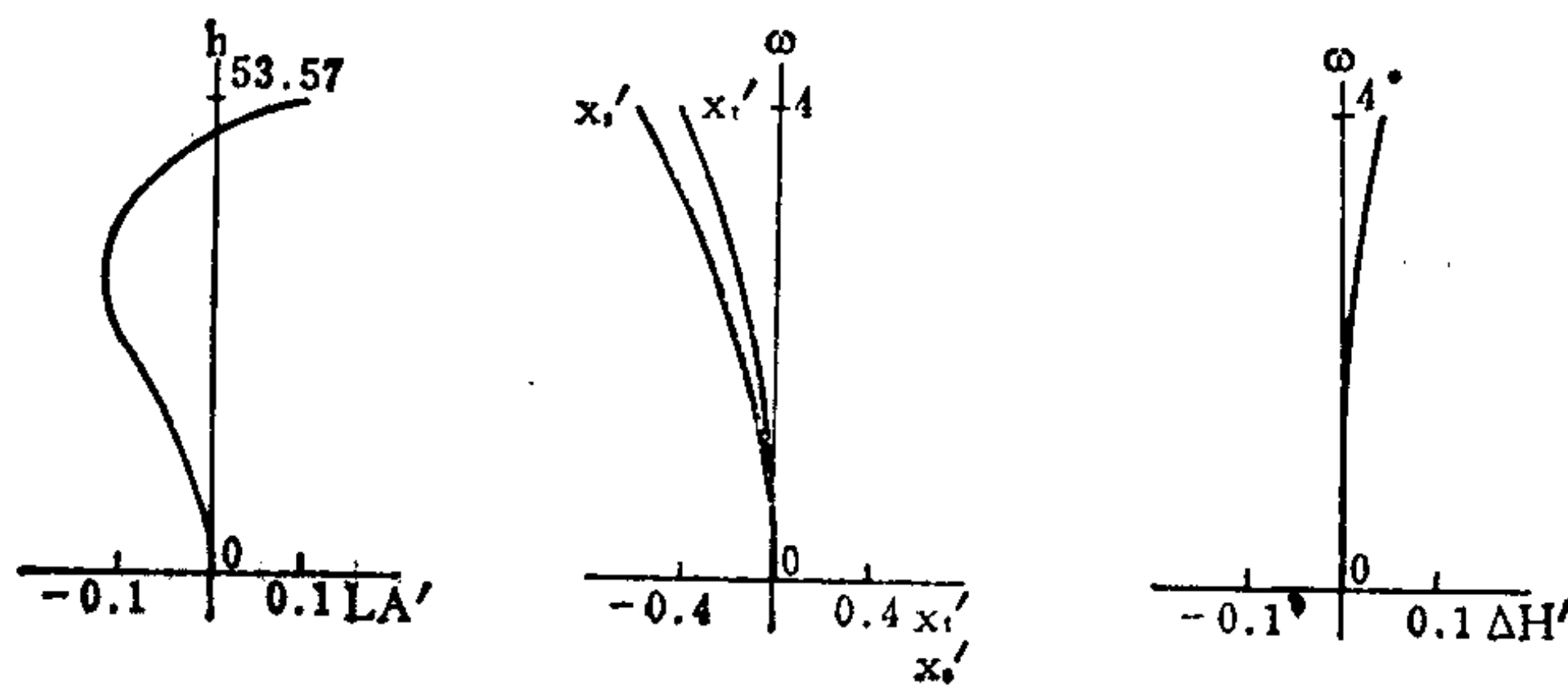

编号: 07-04-081

消色差物镜

E.F.L=800

B.F.L=241.08

FNo.=8

F.A.=±3°

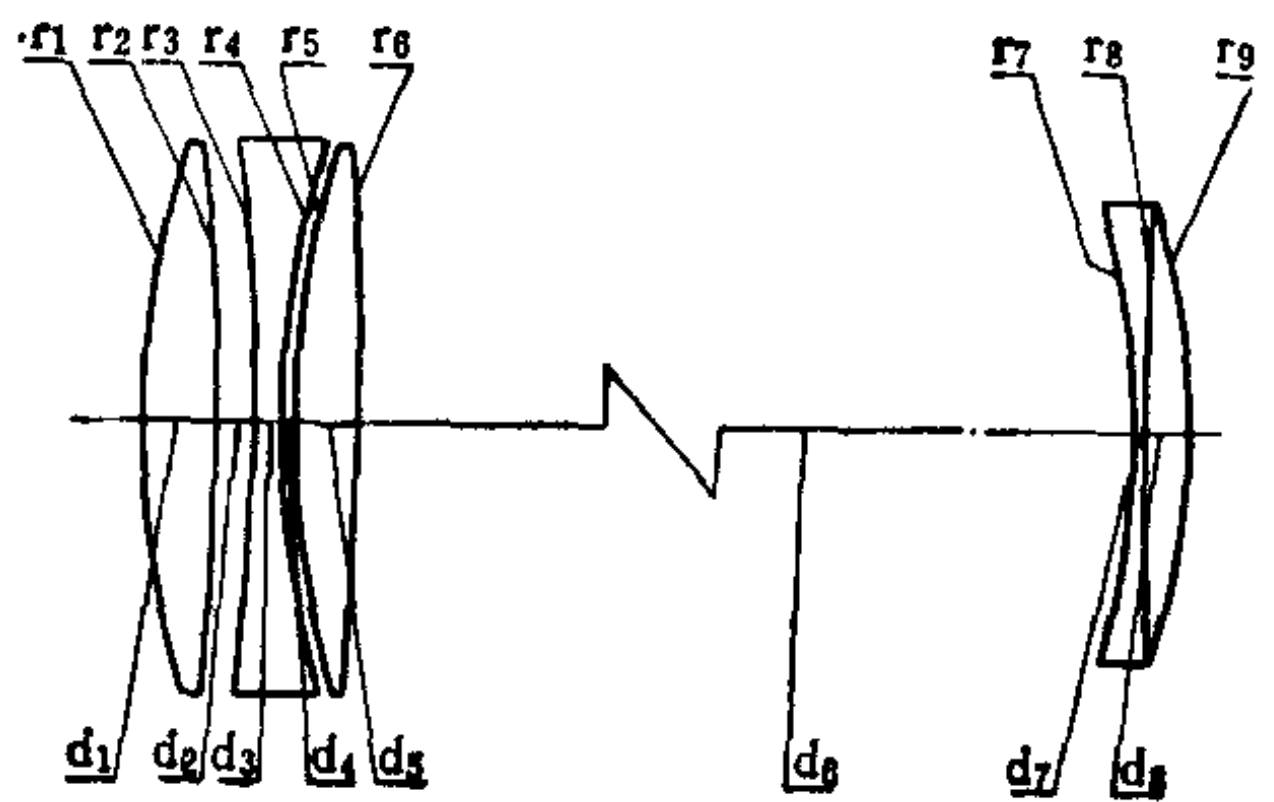

序号	r	d	na	va	序号	r	d	na	va
1	305.0	13.0	1.50032	81.9	6	-2056.2	435.0*		
2	-445.2	7.3			7	-150.0	2.0	1.51885	59.0
3	-391.7	7.5	1.61266	44.3	8	∞	5.0	1.62399	47.0
4	310.3	1.5			9	-233.7			
5	290.0	10.0	1.56965	49.5					

435.0* = 22.0 + 413.0

	ΣS_1	ΣS_2	ΣS_3	ΣS_4	ΣS_5	HI	QP(1 ω)
	-0.00177	0.00062	0.00005	-0.00302	0.01158	41.9	0.2%
h 或 ω %	LA'	$\Delta H'$	x'_t	x'_s	$x'_t - x'_s$	K'_{T1}	$K'_{T0.7}$
100	0.0127	0.093	-0.343	-0.374	0.031	0.00770	0.00721
70	-0.0557	0.033	-0.177	-0.188	0.011	0.00337	0.00407

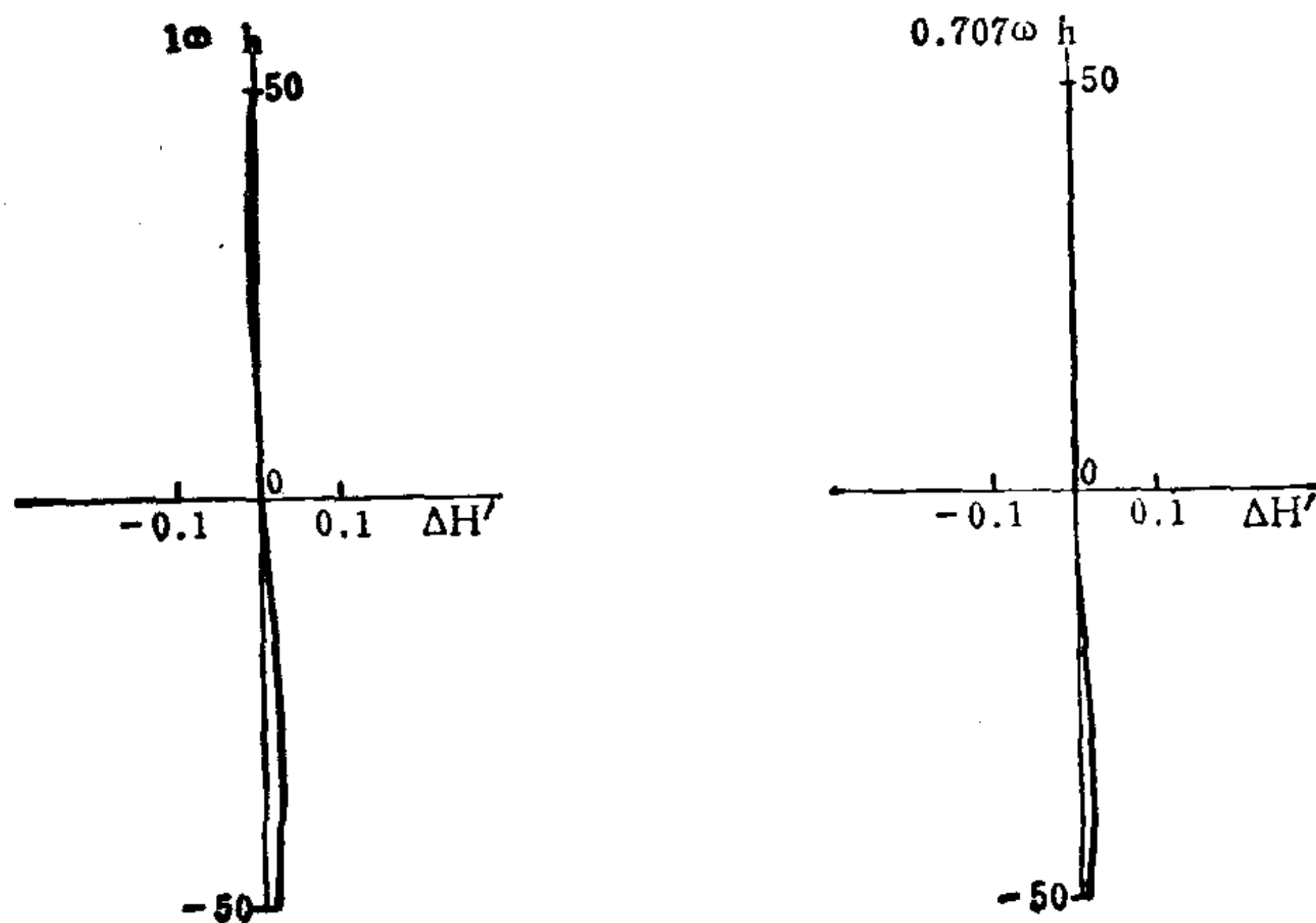
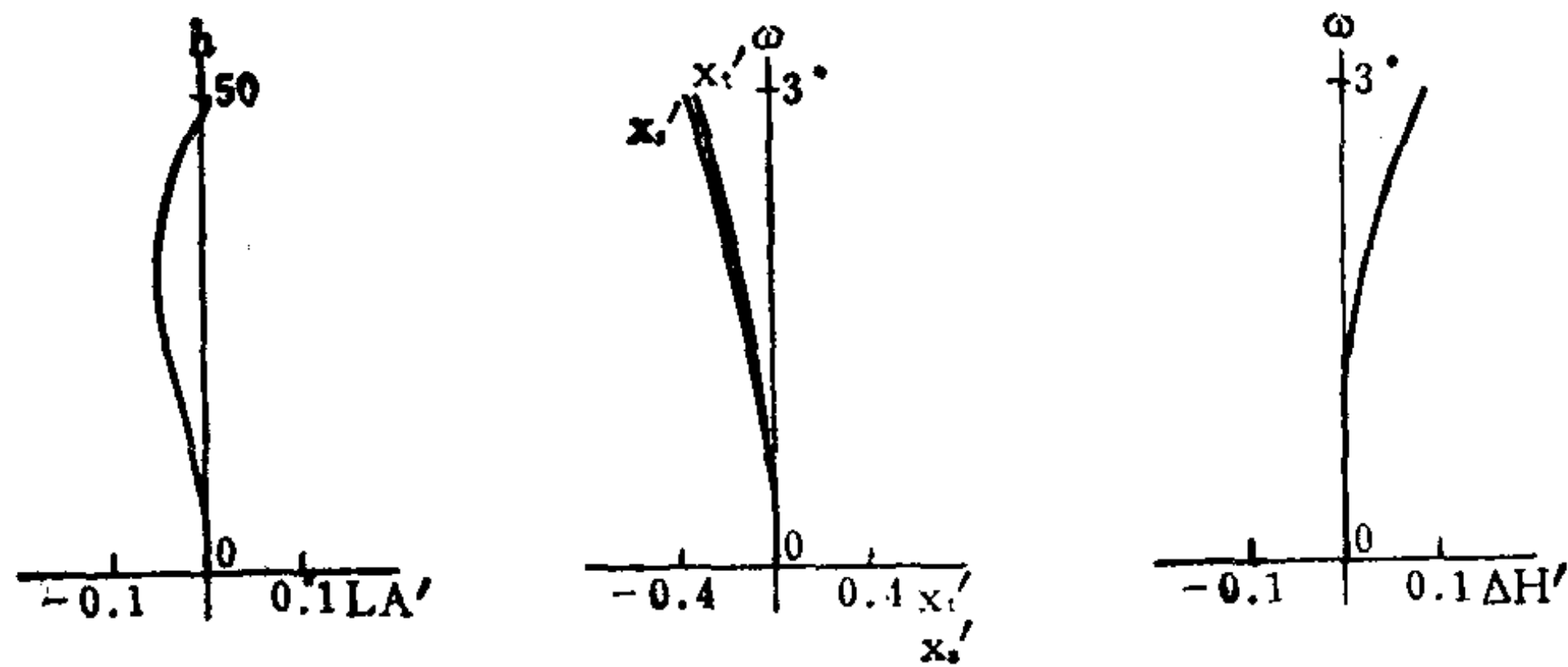

编号: 07-04-082

消色差物镜

E.F.L = 1200

B.F.L = 240.04

FNo. = 11

F.A. = ±2.5°

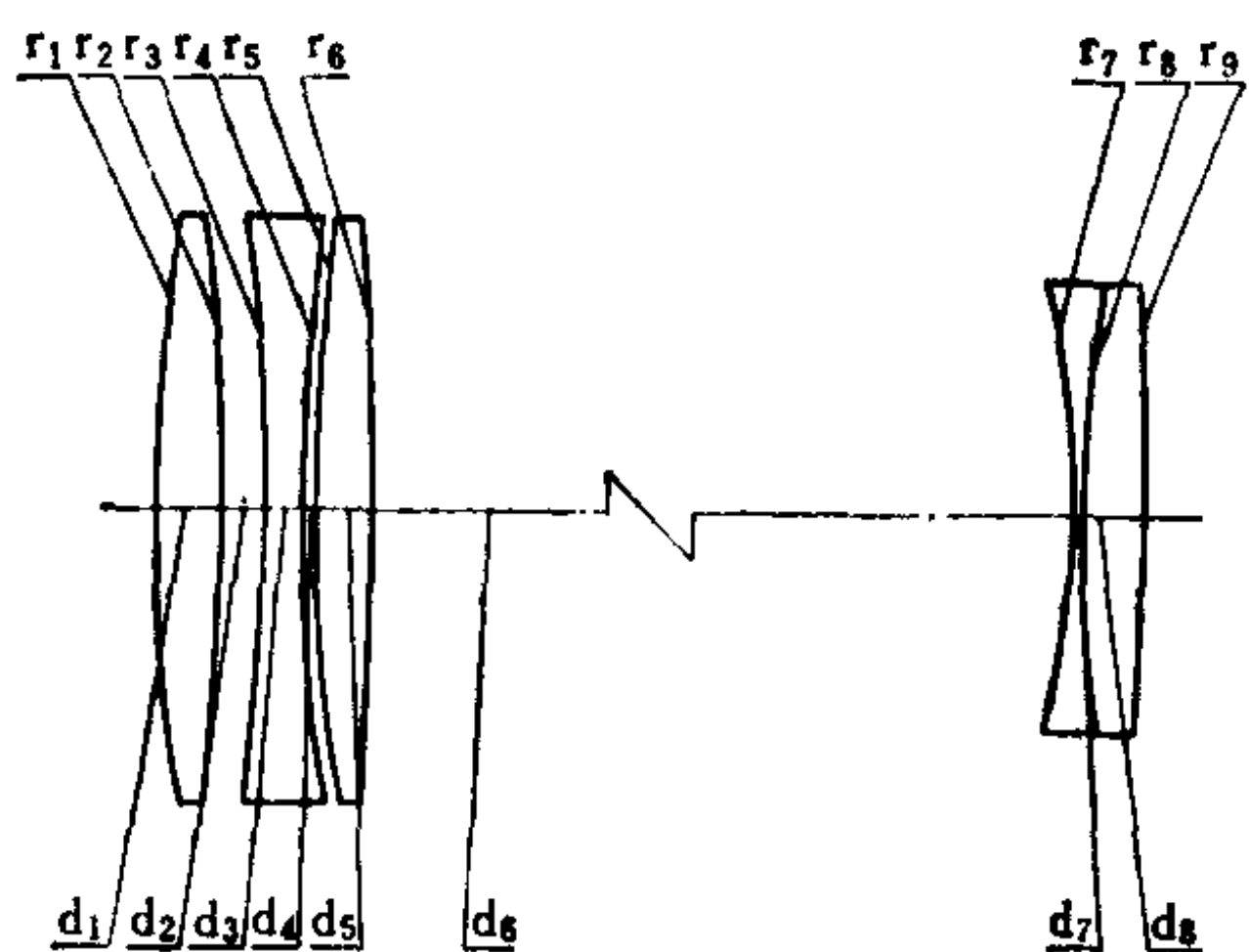

序号	r	d	n_d	v_d	序号	r	d	n_d	v_d
1	412.0	13.0	1.50032	81.9	6	-873.9	659.0*		
2	-435.3	8.0			7	-195.0	2.0	1.51632	64.2
3	-403.2	8.0	1.74400	44.9	8	439.2	7.0	1.66854	39.2
4	445.2	2.0			9	-927.5			
5	396.7	10.0	1.62374	47.0					

659.0* = 50.0 + 609.0

	ΣS_1	ΣS_2	ΣS_3	ΣS_4	ΣS_5	HI	QP(1 ω)
	-0.00131	0.00073	-0.00103	0.00118	0.01345	52.3	0.28%
h 或 ω %	LA'	$\Delta H'$	x'_t	x'_s	$x'_t - x'_s$	K'_{t1}	$K'_{t0.7}$
100	-0.0875	0.148	-0.415	0.061	-0.476	0.00899	0.00929
70	-0.0919	0.052	-0.209	0.035	-0.244	0.00508	0.00592

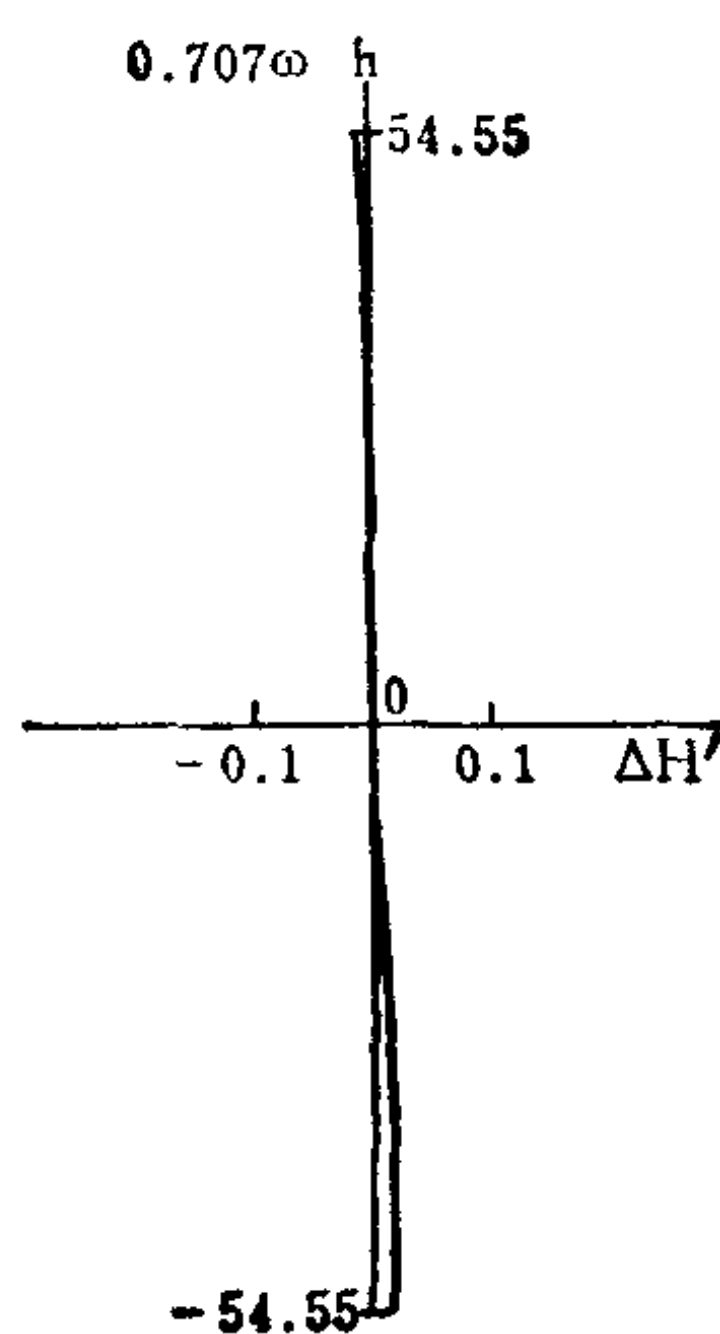
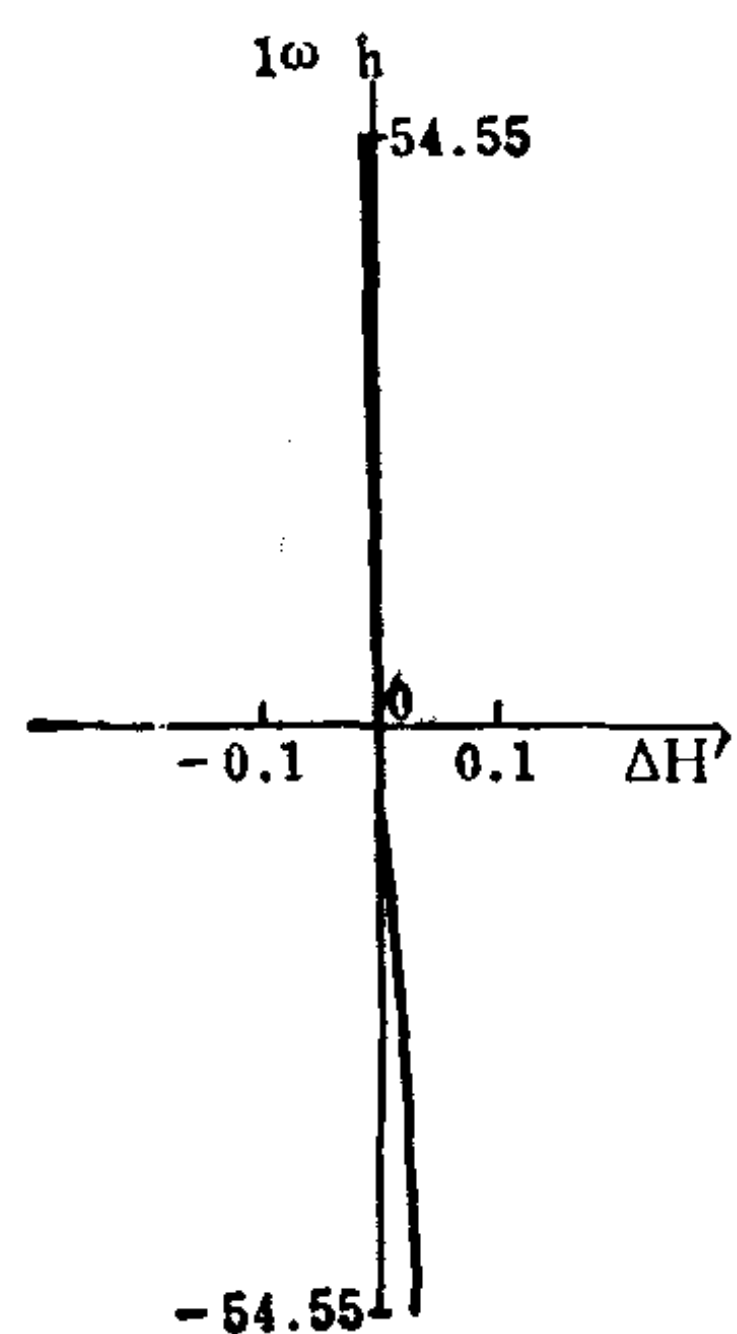
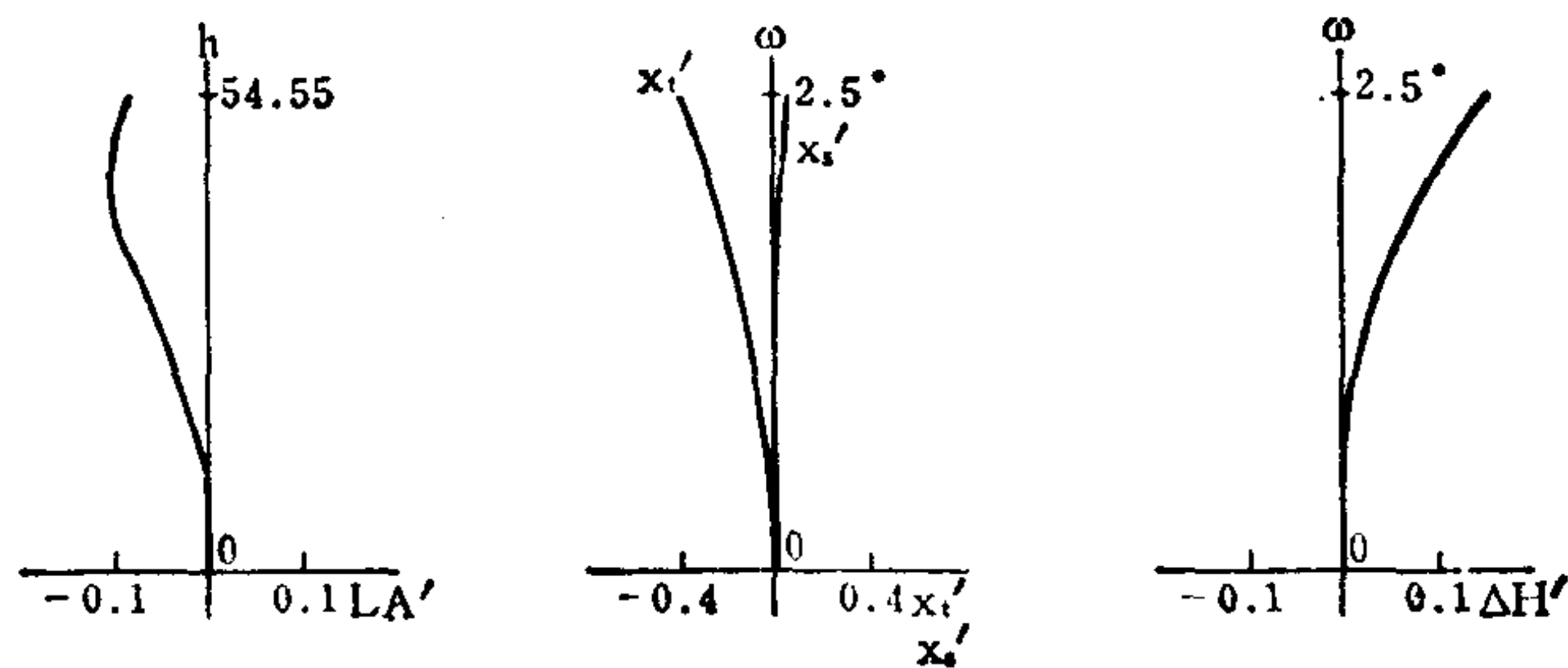

编号: 07-04-083

长焦距折反射式物镜

E.F.L=1003.3 B.F.L=51.3 FNo.=10 F.A.=±1.5°** L'p1=0

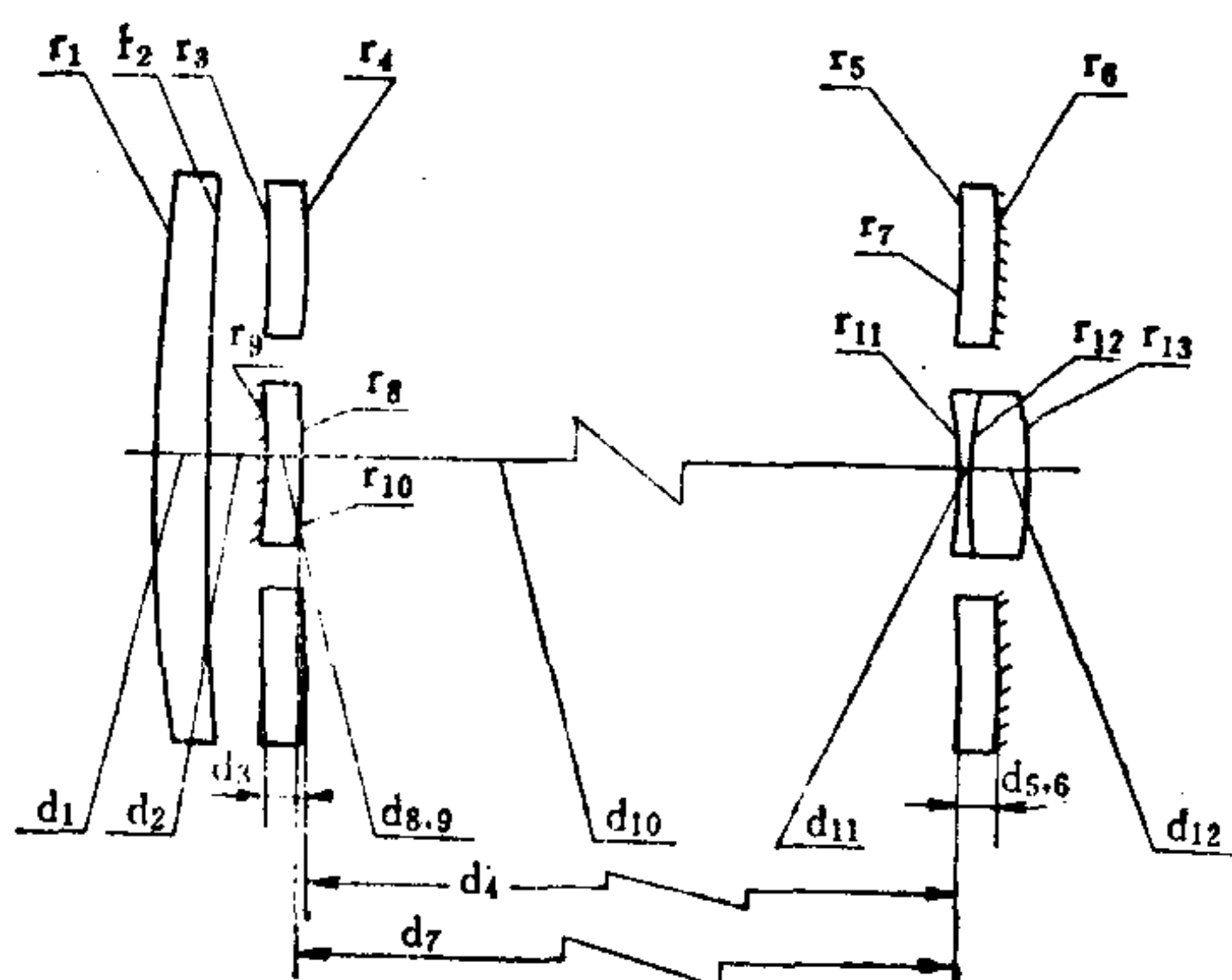

序号	r	d	n	v	序号	r	d	n	v
1	440.0	7	1.50977	62.1	8	-1200.0	-3	-1.64000	60.2
2	1691.6	6	1.00000		9	-450.0	3	1.64000	60.2
3	-533.0	5	1.62606	39.1	10	-1200.0	180	1.00000	
4	-882.2	180	1.00000		11	-100.0	2	1.77252	49.6
5	-700.0	5	1.51823	59.0	12	55.0	7	1.67270	32.2
6	-661.4	-5	-1.51823	59.0	13	-224.0			
7	-700.0	-182	-1.00000						

	ΣS_1	ΣS_2	ΣS_3	ΣS_4	ΣS_5	HI	QP(1 ω)
	-0.00039	0.00054	-0.00205	0.00428	0.03486	26.3	1.4%
h 或 ω %	LA'	$\Delta H'$	x'_t	x'_s	$x'_t - x'_s$	K'_{T1}	$K'_{T0.7}$
100	-0.0211	0.383	-0.276	0.470	-0.746	0.01772	0.00929
70	-0.0255	0.129	-0.168	0.229	-0.397	0.01134	0.00597

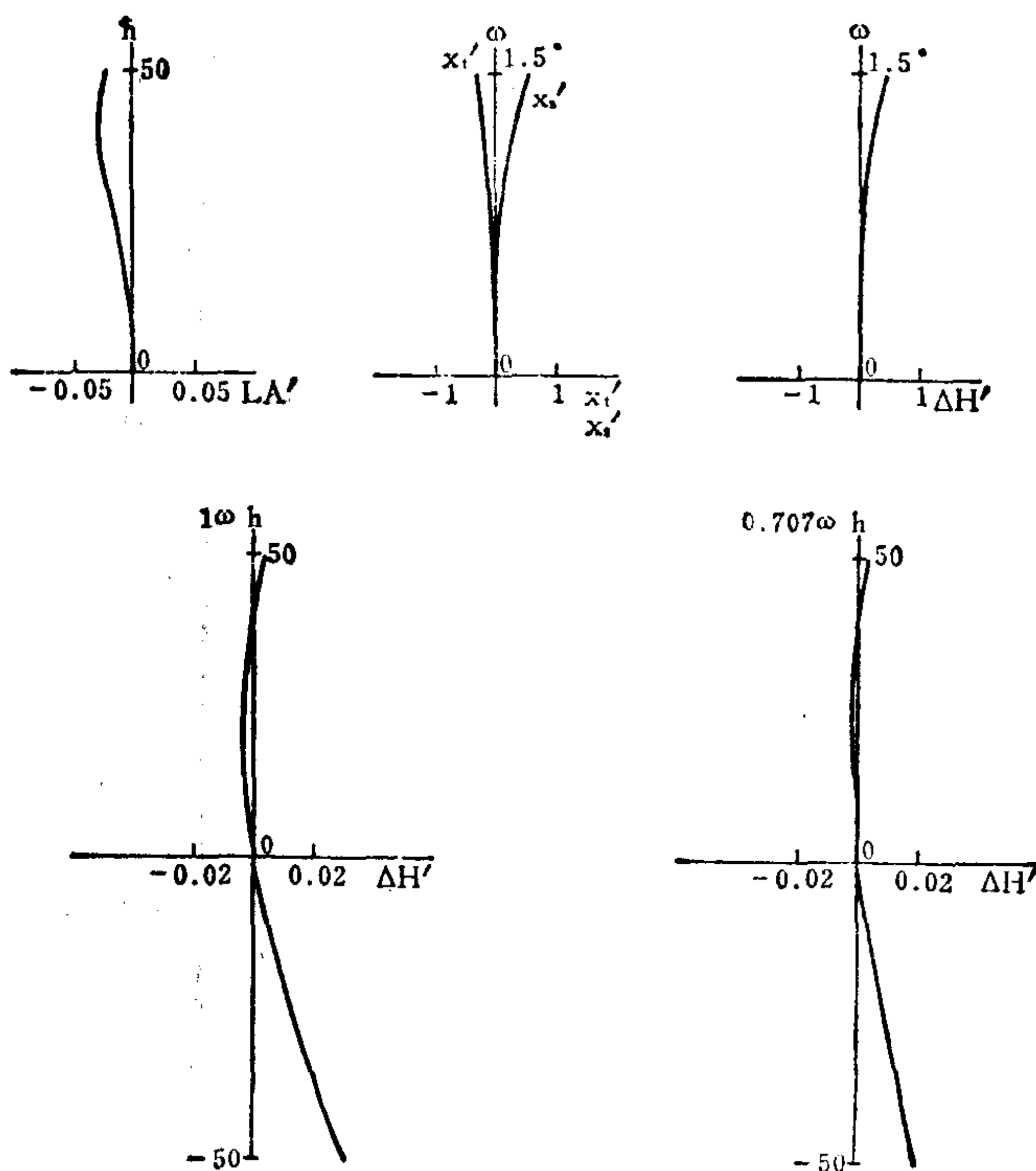

编号: 07-04-084

摄影机用摄影镜头

E.F.L=1

B.F.L=0.804

FNo.=3.5

F.A.=±24°

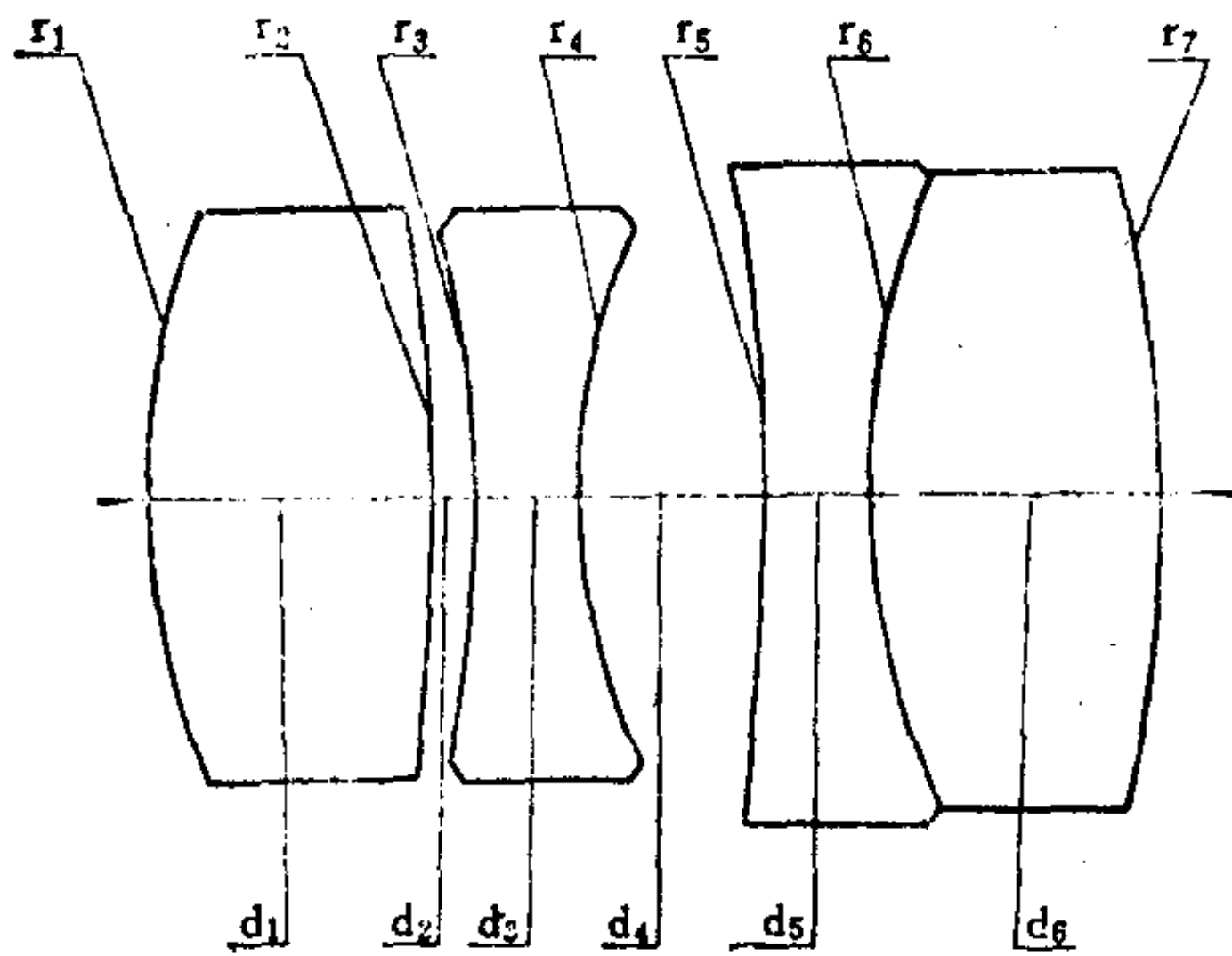

序号	r	d	n	v	序号	r	d	n	v
1	0.4254	0.136	1.71300	53.9	5	-3.0150	0.050	1.51118	50.9
2	-1.3100	0.016			6	0.4065	0.142	1.65160	58.5
3	-0.6766	0.050	1.59551	39.0	7	-0.5400			
4	0.3070	0.085*							

0.085* = 0.045 + 0.040

	ΣS_1	ΣS_2	ΣS_3	ΣS_4	ΣS_5	HI	QP(1 ω)
	-0.000397	0.000516	0.000128	-0.000963	-0.001662	0.44	-1.9%
h 或 ω %	LA'	$\Delta H'$	x'_t	x'_s	$x'_t - x'_s$	K'_{T1}	$K'_{T0.7}$
100	0.00263	-0.00868	-0.01514	-0.00793	-0.00721	0.13739	-0.00205
70	-0.00230	-0.00266	-0.00478	-0.00750	0.00272	-0.00383	0.00001

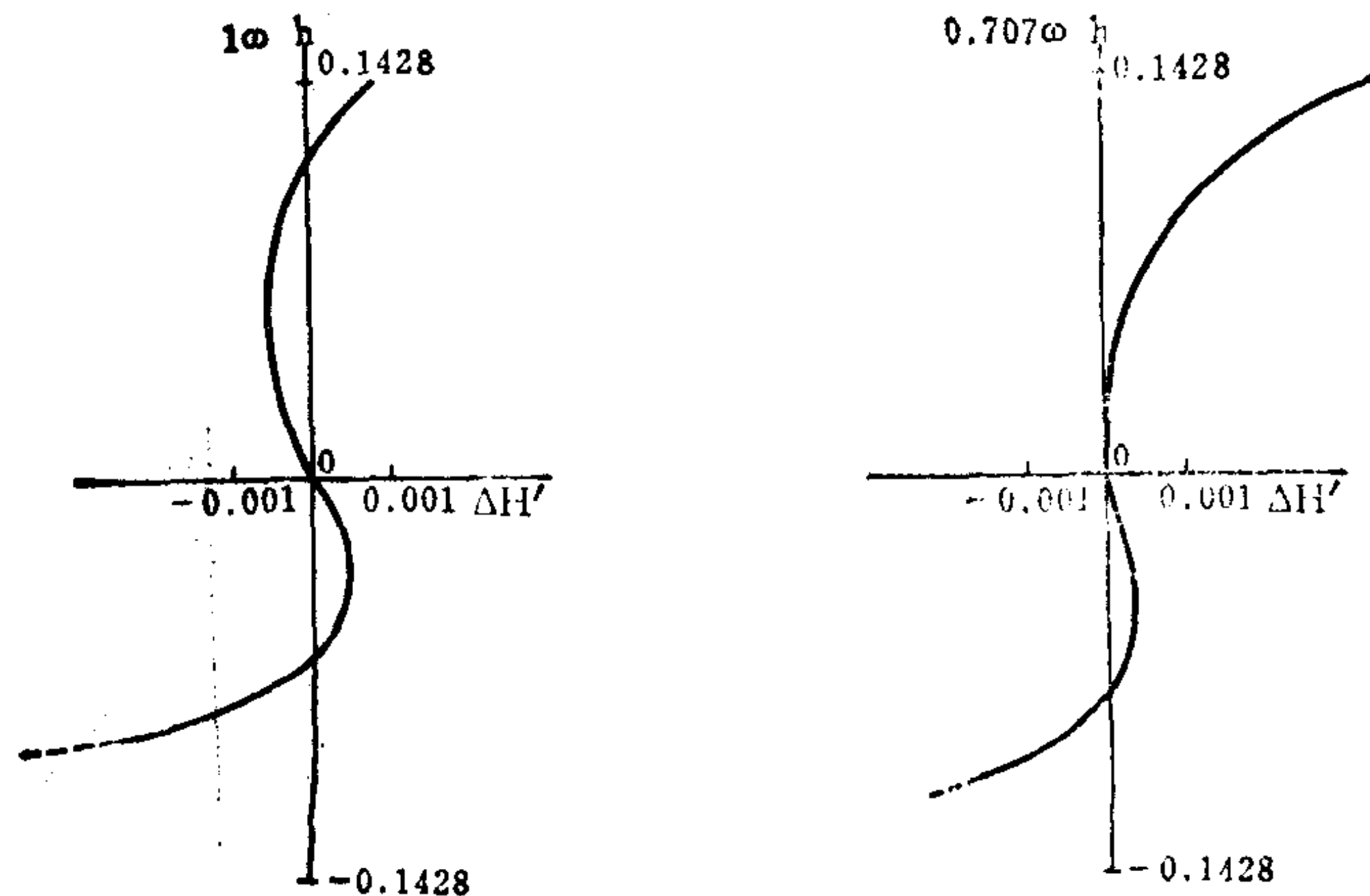
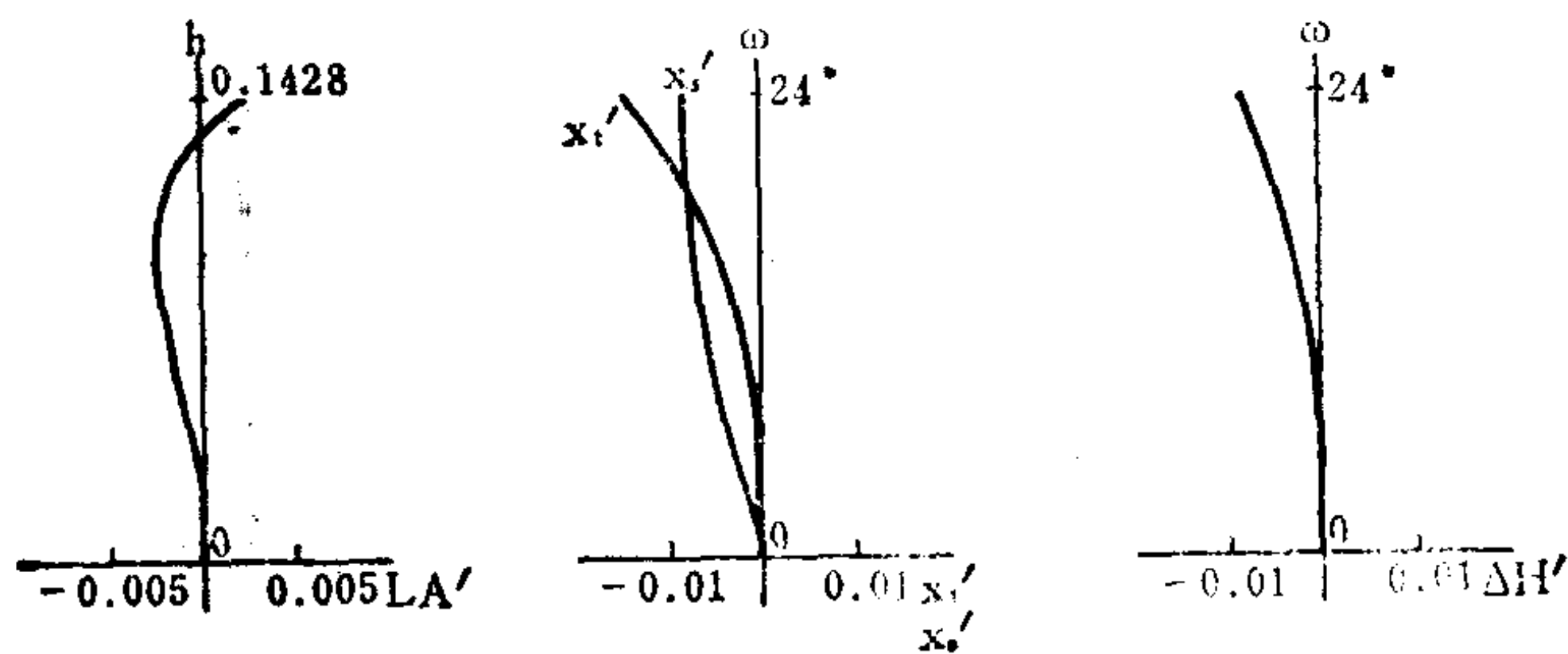

编号: 07-04-085

超远摄物镜

E.F.L.=48.15

B.F.L.=6.83

FNo.=11

F.A.=±1.3°

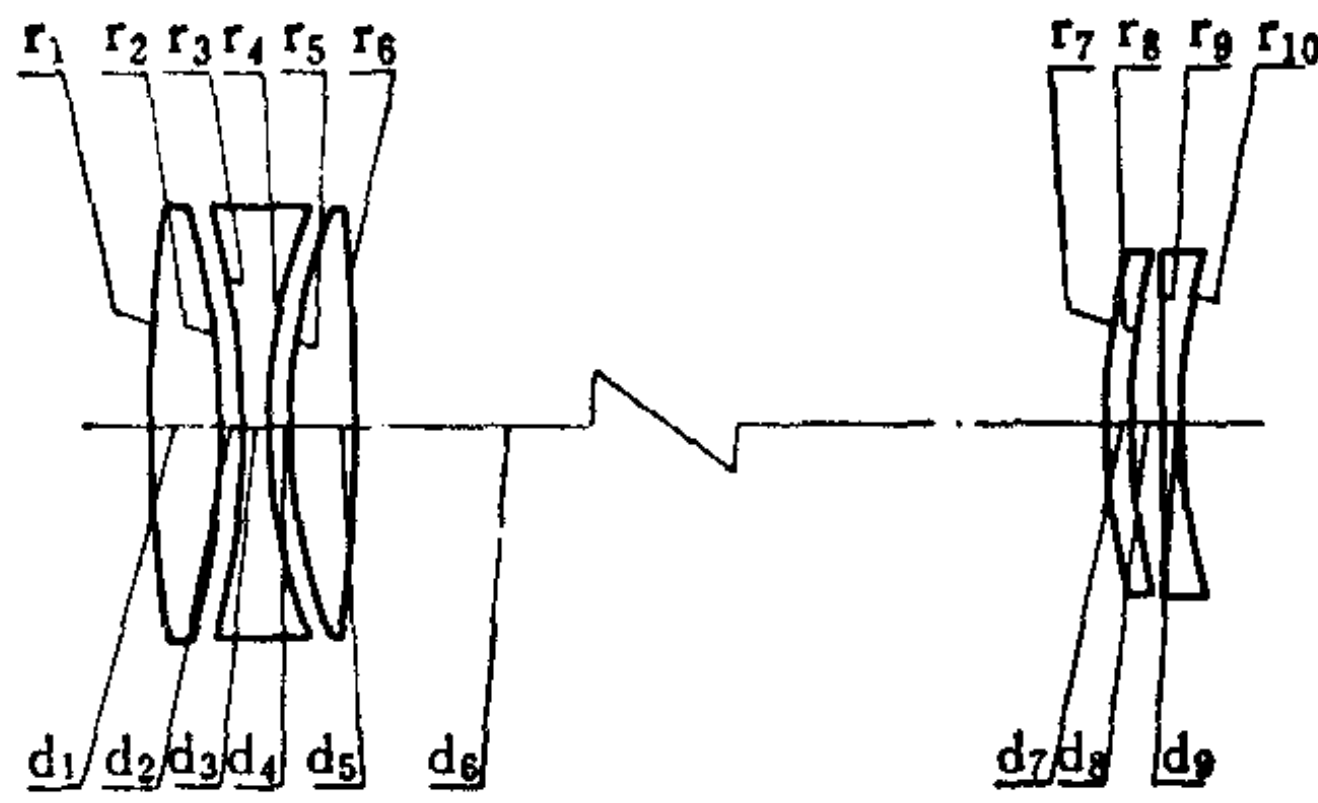

序号	r	d	n	v	序号	r	d	n	v
1	38.079	1.351	1.6180	63.38	6	-113.167	33.162*		
2	-22.975	0.014			7	23.928	0.299	1.6990	30.10
3	-28.811	0.800	1.7552	27.50	8	65.522	0.050		
4	12.937	0.209			9	∞	0.370	1.5687	63.10
5	13.323	1.325	1.7847	25.60	10	11.799			

33.162* = 17.000 + 16.162

	ΣS_1	ΣS_2	ΣS_3	ΣS_4	ΣS_5	HI	QP(1 ω)
	-0.001419	0.000638	-0.000386	0.000011	0.000265	1	0.27%
h 或 ω %	LA'	$\Delta H'$	x'_t	x'_s	$x'_t - x'_s$	K'_{T1}	$K'_{T0.7}$
100	-0.346	0.0029	-0.276	-0.091	-0.185	0.02236	0.01095
70	-0.172	0.0010	-0.138	-0.045	-0.093	0.01564	0.00766

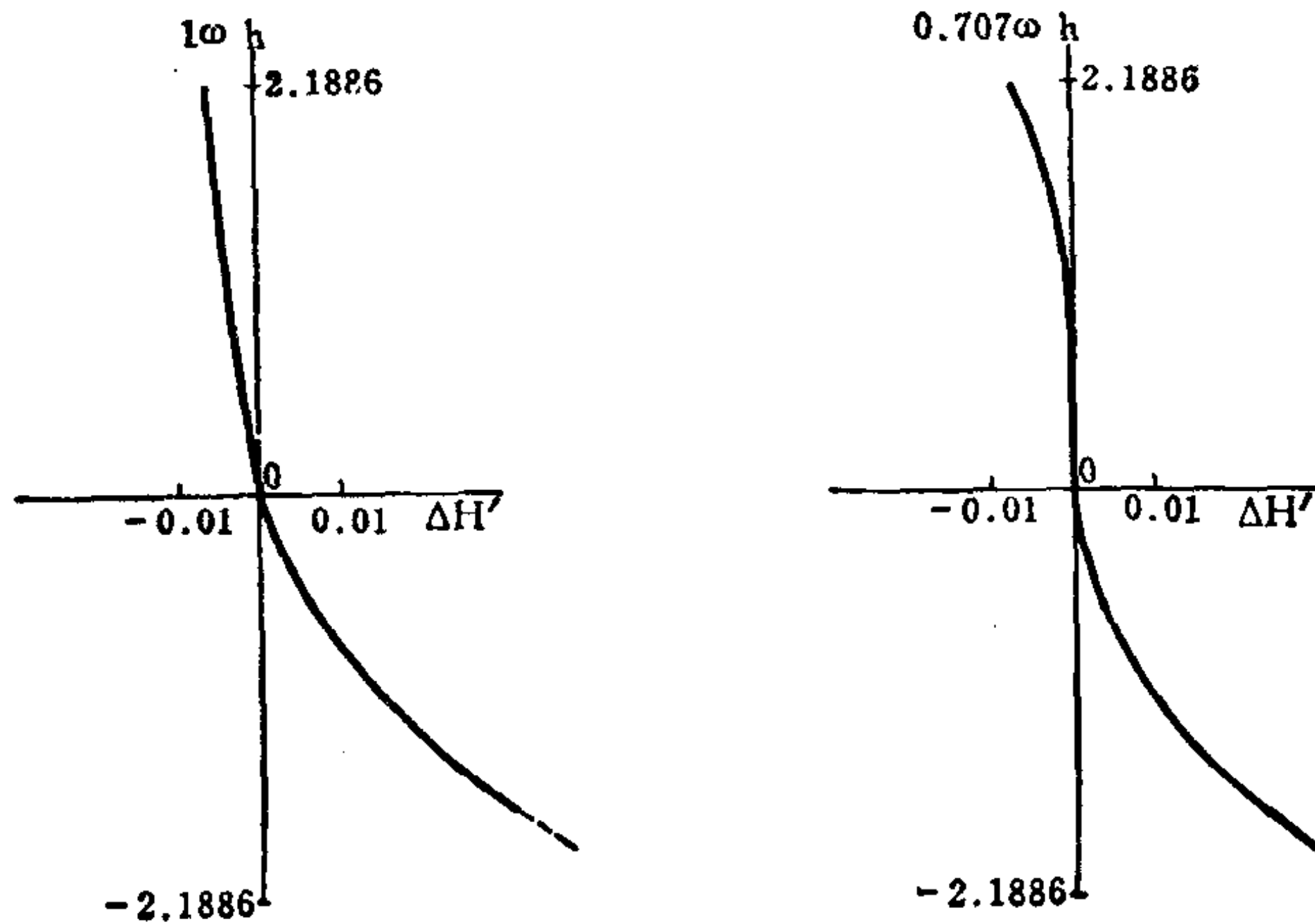
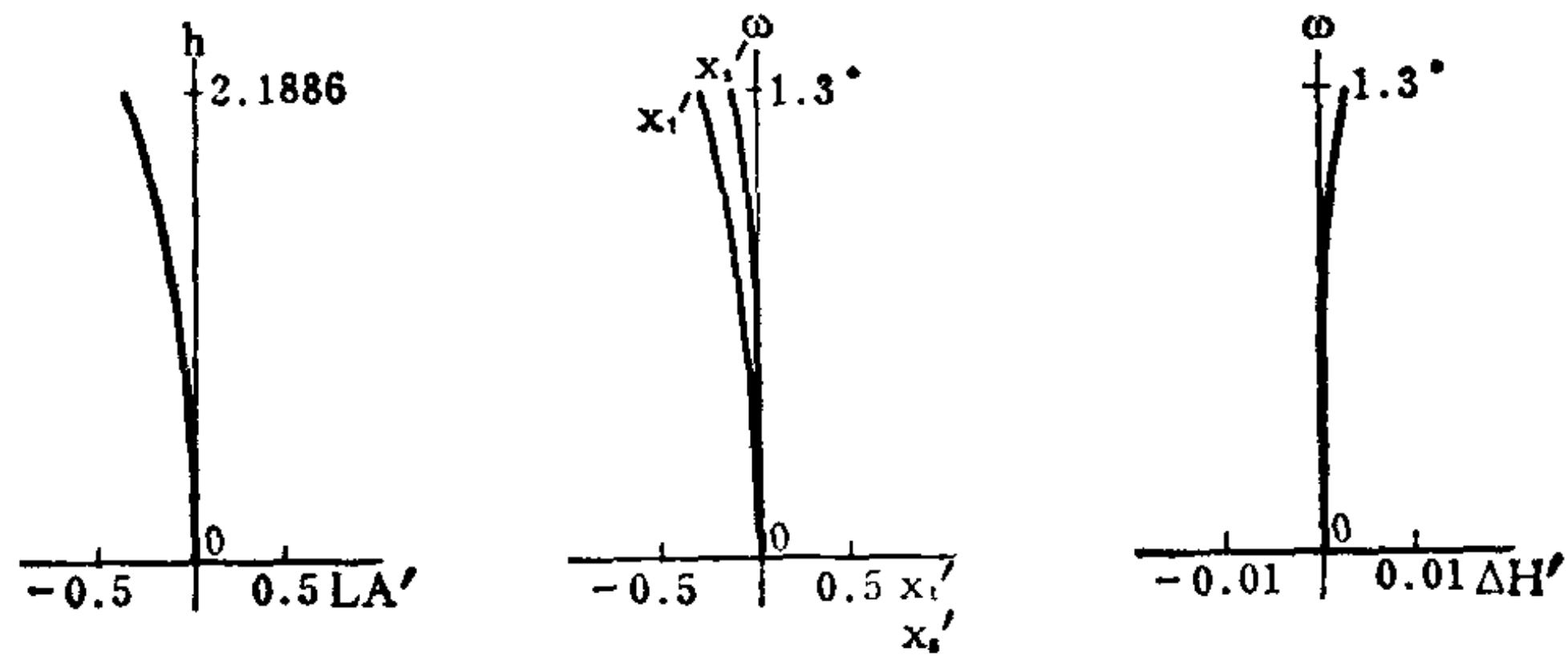

编号: 07-04-086

小型远摄物镜

E.F.L=99.98

B.F.L=40.30

FNo.=3.5

F.A.=±9°

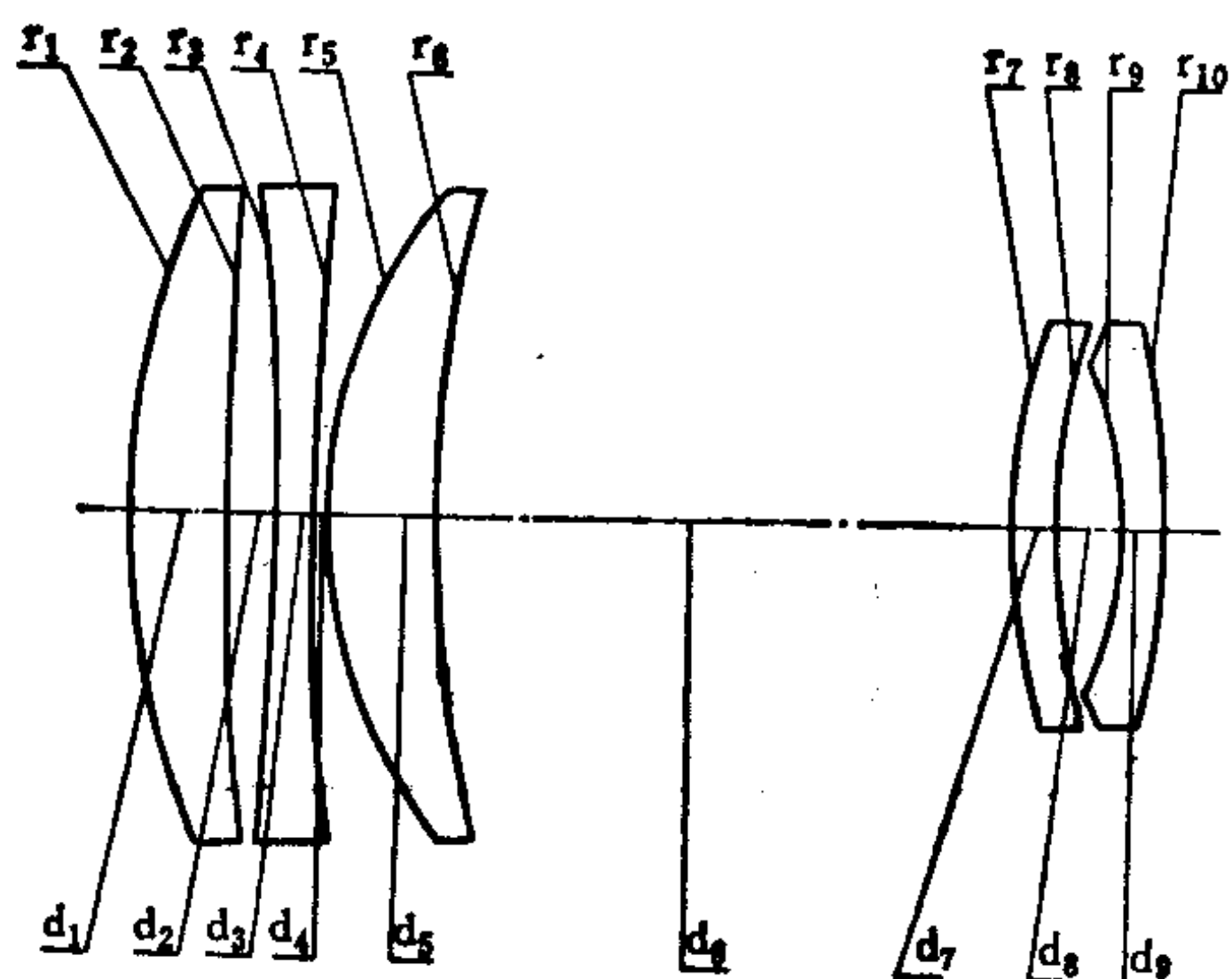

序号	r	d	n	v	序号	r	d	n	v
1	35.11	4.19	1.51633	64.1	6	49.51	23.44*		
2	308.89	1.81			7	26.73	1.93	1.72825	28.5
3	-130.89	1.33	1.78470	26.2	8	47.51	2.48		
4	120.83	0.08			9	-15.46	0.90	1.64000	60.2
5	20.95	4.61	1.51821	65.0	10	-52.20			

23.44* = 12.00 + 11.44

	ΣS_1	ΣS_2	ΣS_3	ΣS_4	ΣS_5	HI	QP(1 ω)
	-0.01861	-0.00875	-0.00347	-0.00062	0.04974	15.8	1%
h 或 ω %	LA'	$\Delta H'$	x'_t	x'_s	$x'_t - x'_s$	K'_{T1}	$K'_{T0.7}$
100	-0.0819	0.164	-0.148	-0.059	-0.089	0.3104	0.0579
70	-0.1269	0.060	-0.104	-0.040	-0.064	0.1433	0.0129

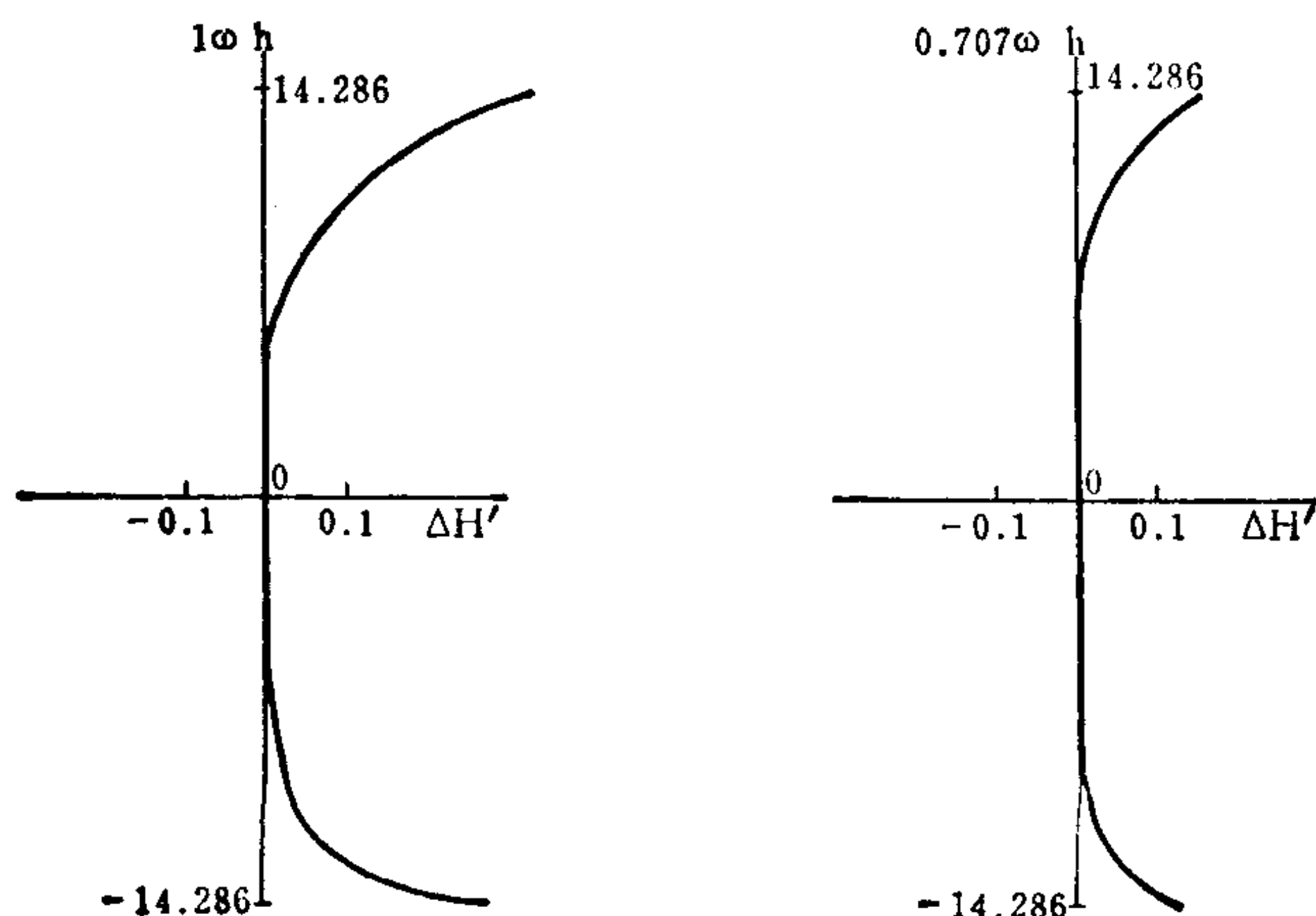
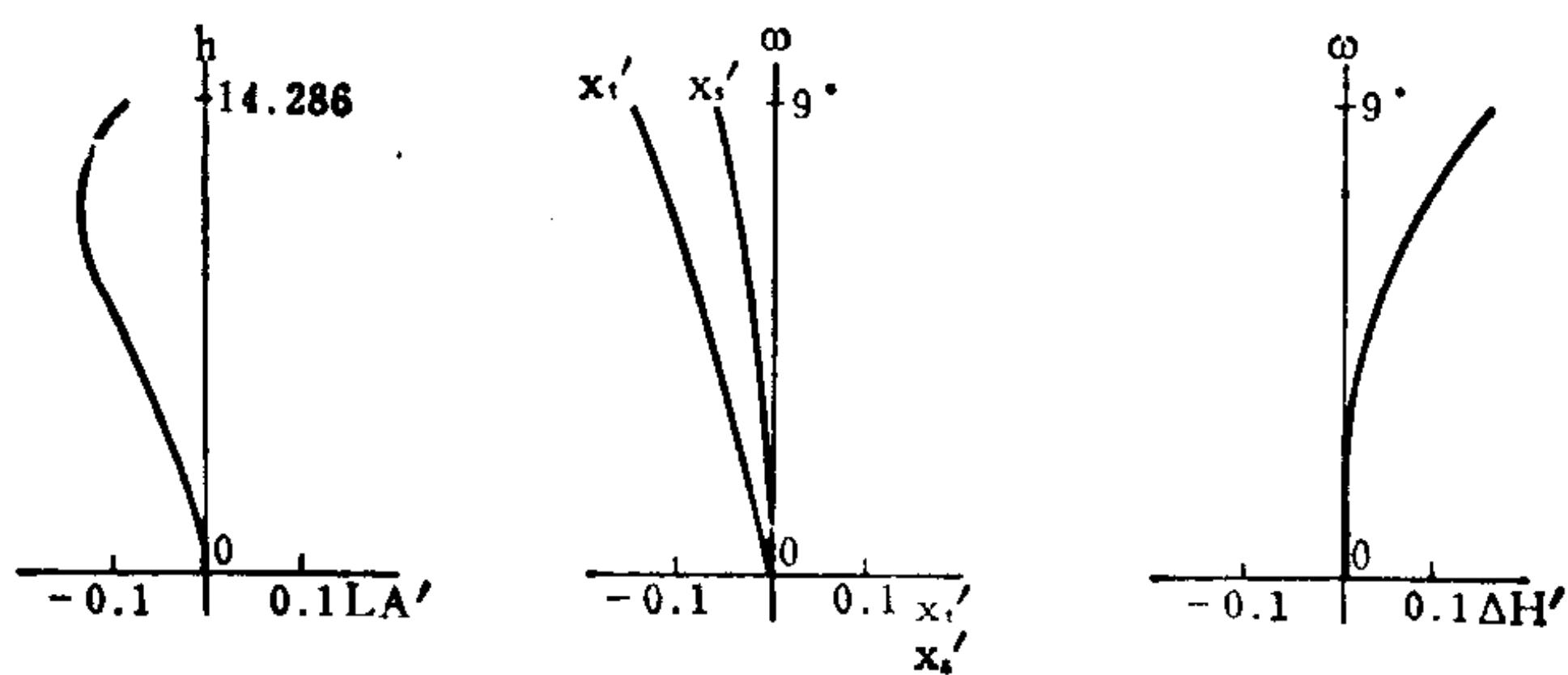

编号: 07-04-087

小型远摄物镜

E.F.L=100

B.F.L=40.38

FNo.=3.5

F.A.=±8.2°

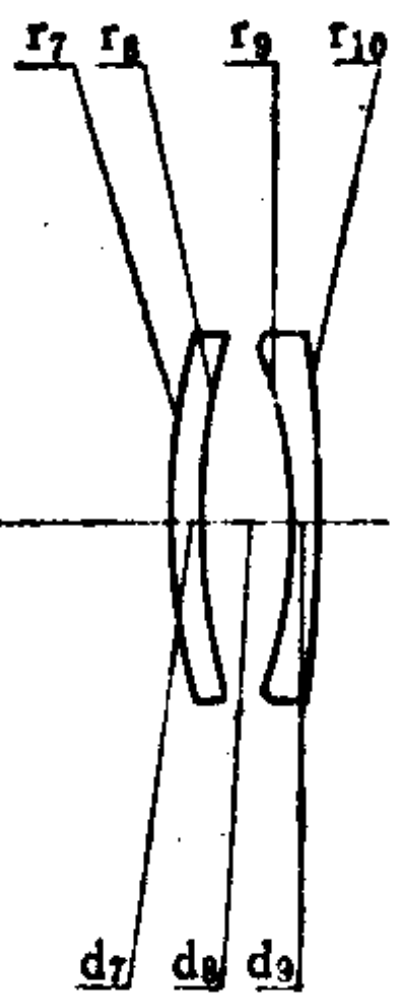
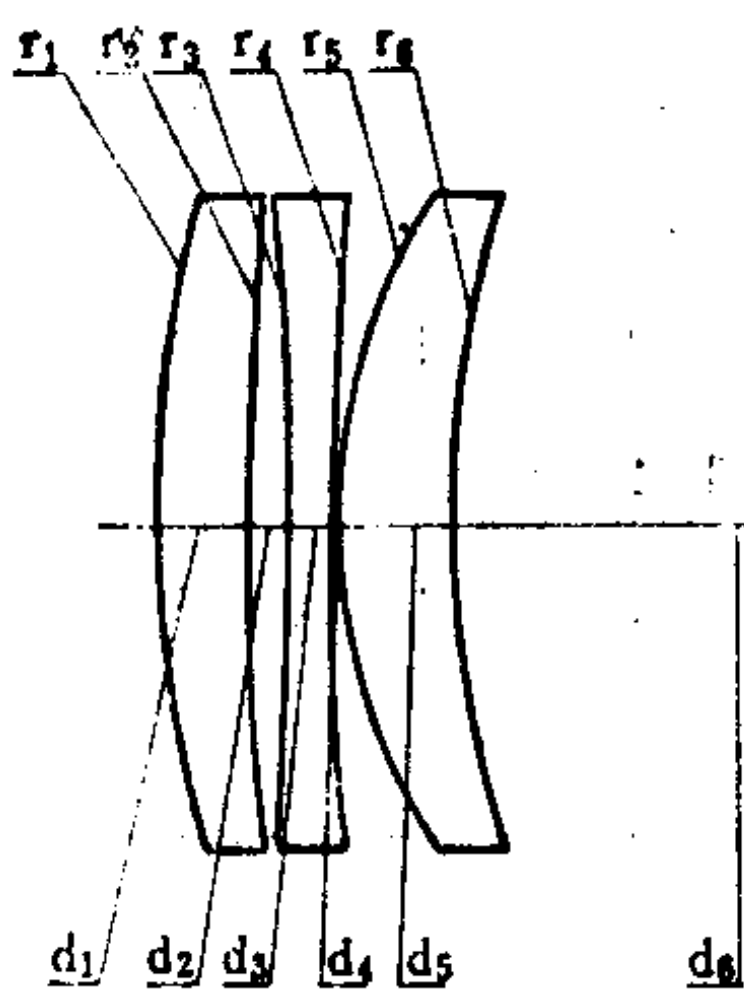

序号	r	d	n	v	序号	r	d	n	v
1	33.81	3.54	1.51112	60.5	6	45.19	23.99*		
2	428.55	1.41			7	27.41	1.21	1.72825	28.5
3	-145.86	1.33	1.80518	25.4	8	55.22	2.72		
4	118.64	0.07			9	-15.87	0.80	1.65160	58.6
5	20.57	3.87	1.51633	64.1	10	-67.11			

23.99* = 12.00 + 11.99

	ΣS_1	ΣS_2	ΣS_3	ΣS_4	ΣS_5	HI	QP(1 ω)
	-0.01688	-0.00577	-0.00352	-0.00073	0.04176	14.4	0.98%
h 或 ω %	LA'	$\Delta H'$	x'_i	x'_s	$x'_i - x'_s$	K'_{T1}	$K'_{T0.7}$
100	0.0786	0.142	-0.152	-0.070	-0.082	0.1697	0.0392
70	-0.0931	0.051	-0.107	-0.044	-0.063	0.0709	0.0060

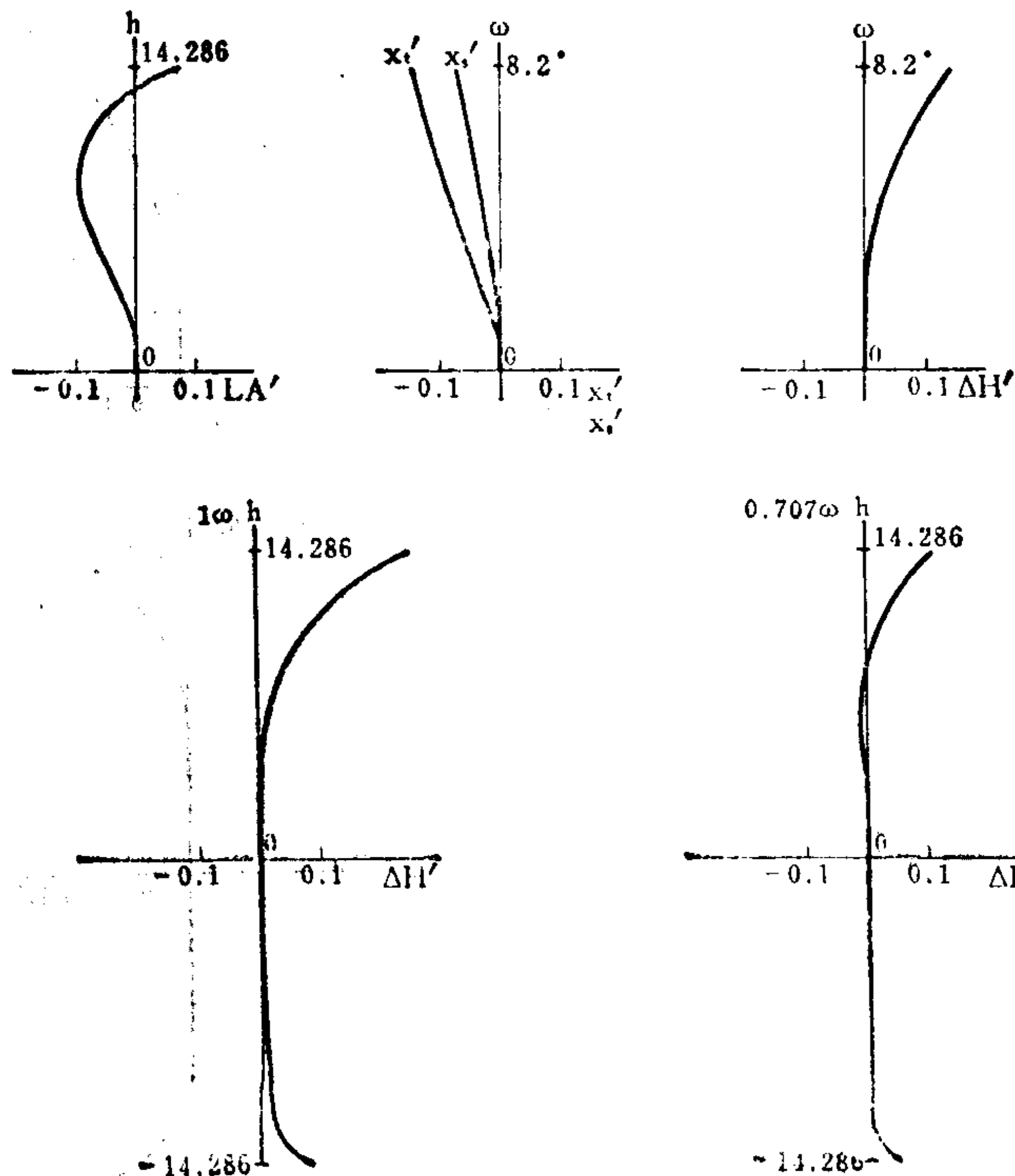

编号: 07-04-088

短的远摄物镜

E.F.L.=1

B.F.L.=0.2707

FNo.=5.6

F.A.=±4.3°

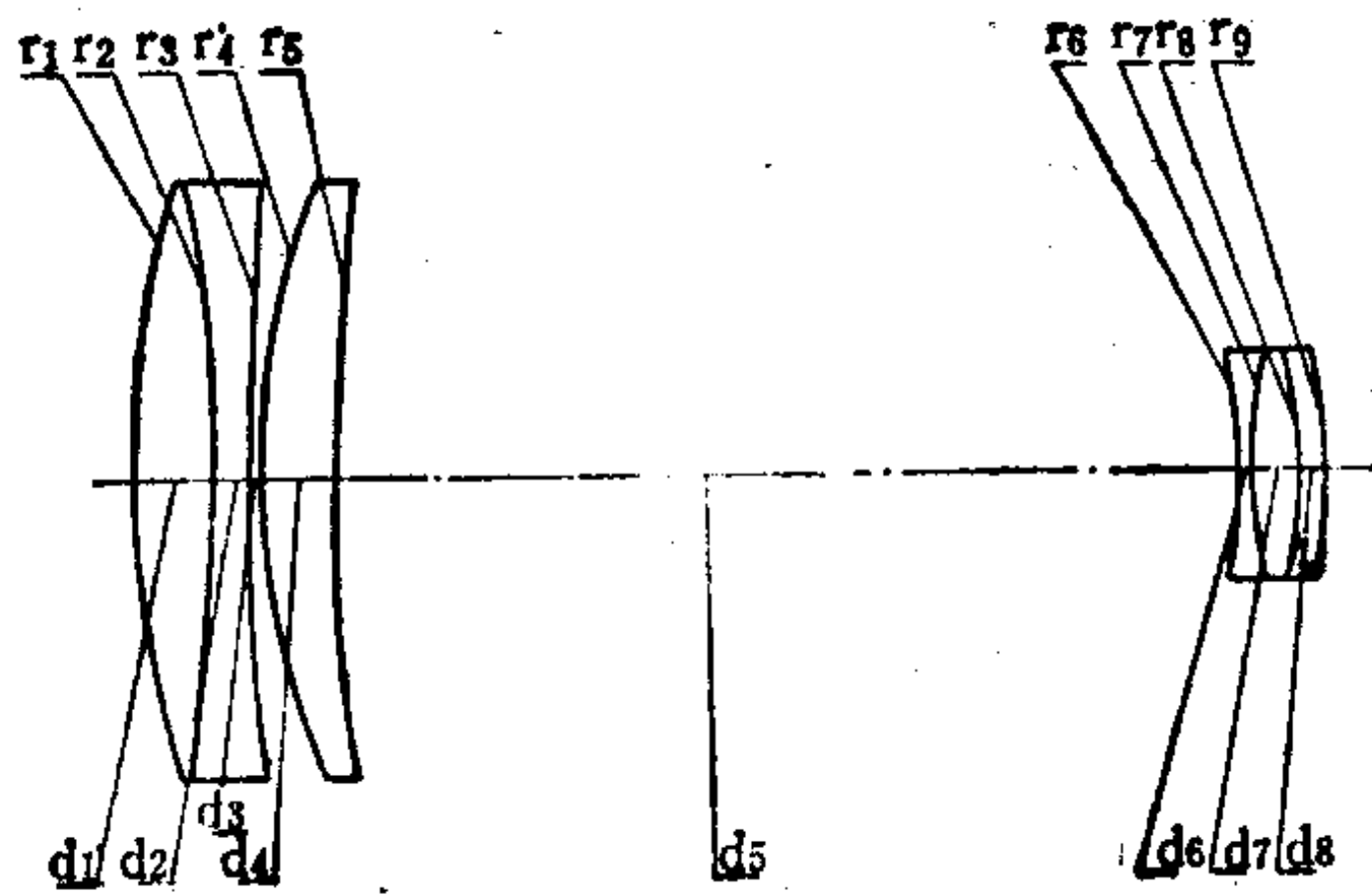

序号	r	d	n	v	序号	r	d	n	v
1	0.38316	0.0258	1.48749	70.4	6	-0.16392	0.0041	1.80420	46.5
2	-0.50344	0.0094	1.68893	31.2	7	0.16392	0.0127	1.59270	35.5
3	2.90232	0.0010			8	-0.08591	0.0045	1.77250	49.6
4	0.22199	0.0245	1.48749	70.4	9	-0.19430			
5	0.77167	0.2955*							

0.2955* = 0.1500 + 0.1455

	ΣS_1	ΣS_2	ΣS_3	ΣS_4	ΣS_5	HI	QP(1 ω)
	-0.000010	-0.000004	-0.000012	0.000002	0.000218	0.075	1.7%
h 或 ω %	LA'	$\Delta H'$	x'_t	x'_s	$x'_t - x'_s$	K'_{T1}	$K'_{T0.7}$
100	-0.00046	0.00128	-0.00162	-0.00056	-0.00106	-0.000127	-0.000071
70	-0.00027	0.00044	-0.00093	-0.00028	-0.00065	-0.000054	-0.000034

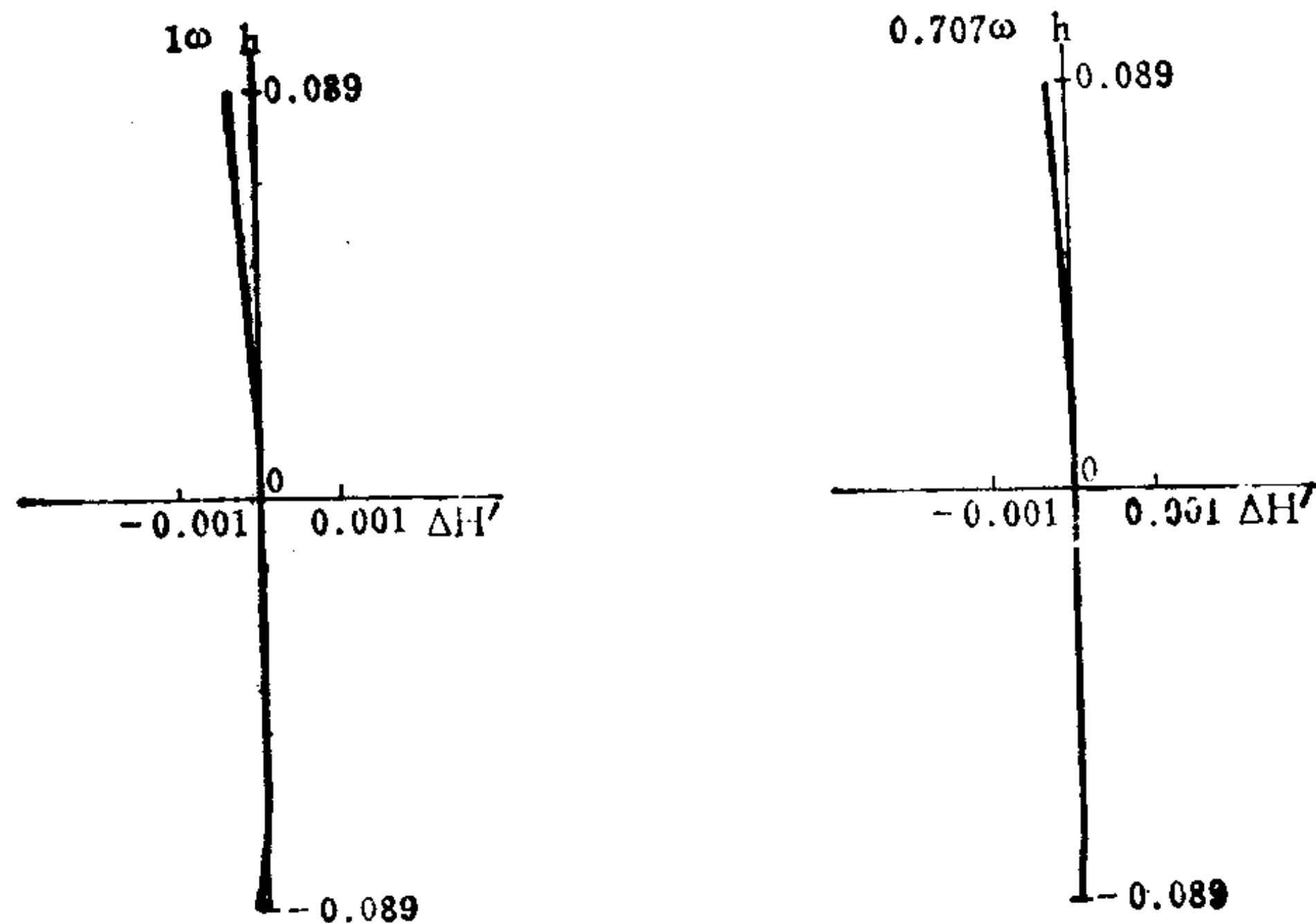
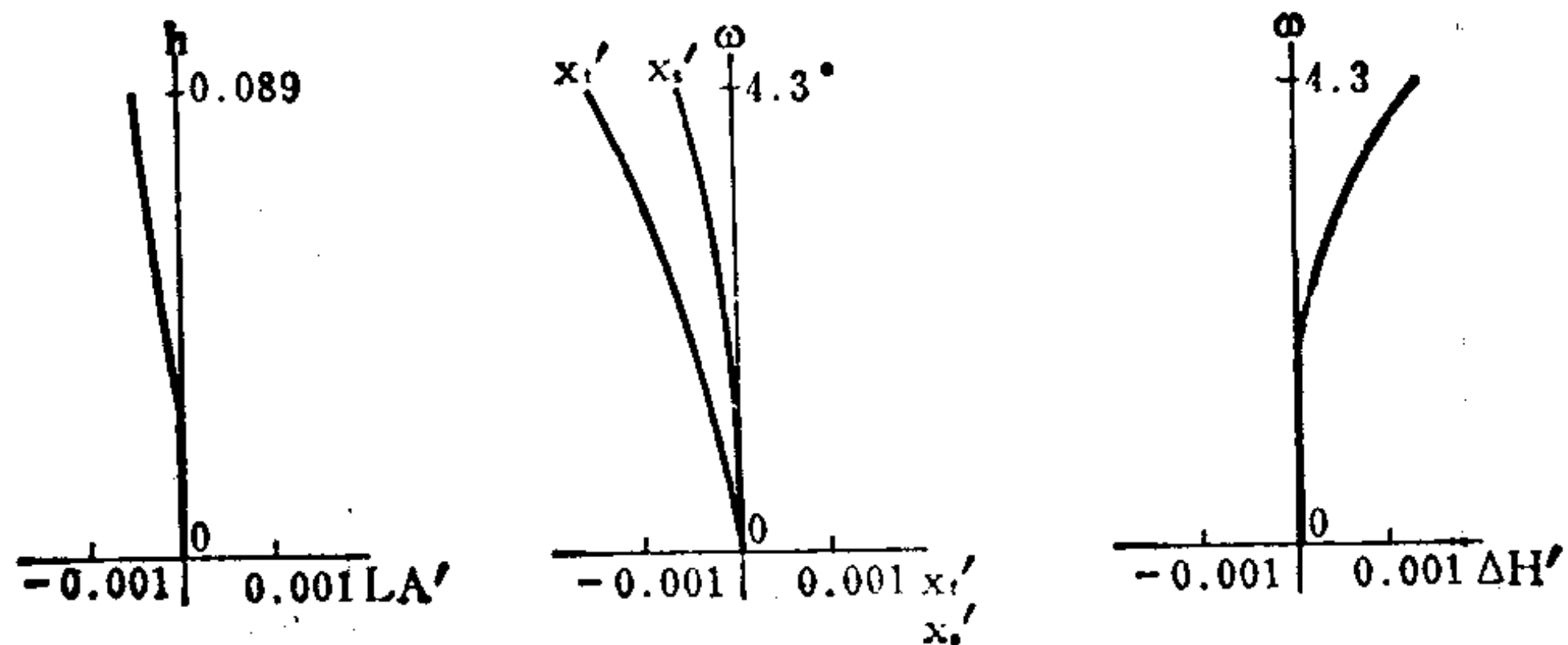

编号: 07-04-089

短的远摄物镜

E.F.L=1

B.F.L=0.2505

FNo.=5.6

F.A.=±4.3°

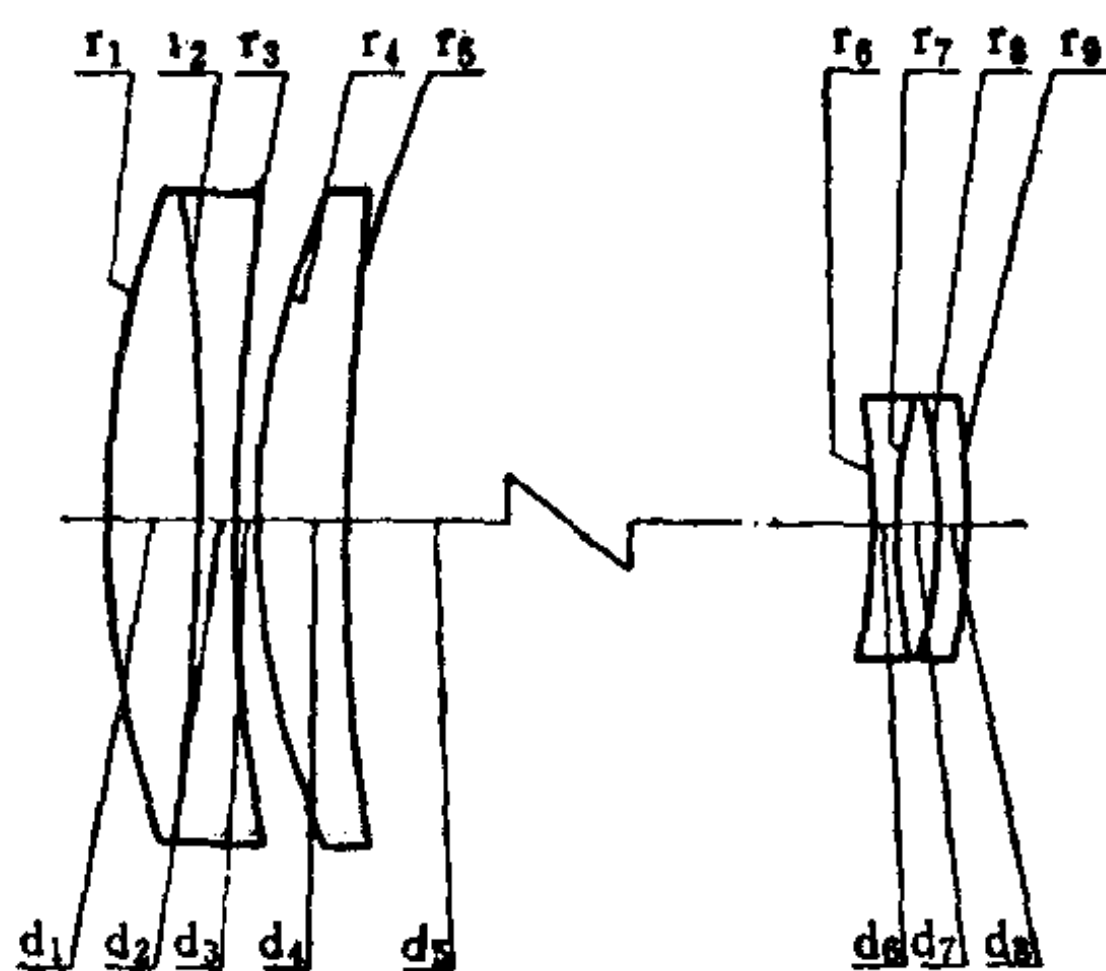

序号	r	d	n	v	序号	r	d	n	v
1	0.36804	0.0258	1.48749	70.4	6	-0.16151	0.0041	1.81600	46.8
2	-0.52062	0.0094	1.75690	31.8	7	0.17148	0.0127	1.59340	34.8
3	3.70050	0.0010			8	-0.08351	0.0045	1.78800	47.5
4	0.23247	0.0245	1.48749	70.4	9	-0.19390			
5	0.97670	0.3058*							

0.3058* = 0.1500 + 0.1558

	ΣS_1	ΣS_2	ΣS_3	ΣS_4	ΣS_5	HI	QP(1 ω)
	-0.000006	-0.000003	-0.000014	0.000005	0.000237	0.075	1.8%
h 或 ω %	LA'	$\Delta H'$	x'_t	x'_s	$x'_t - x'_s$	K'_{T1}	$K'_{T0.7}$
100	-0.00037	0.00139	-0.00196	-0.00055	-0.00141	-0.000152	-0.000081
70	-0.00018	0.00048	-0.00108	-0.00027	-0.00081	-0.000063	-0.000037

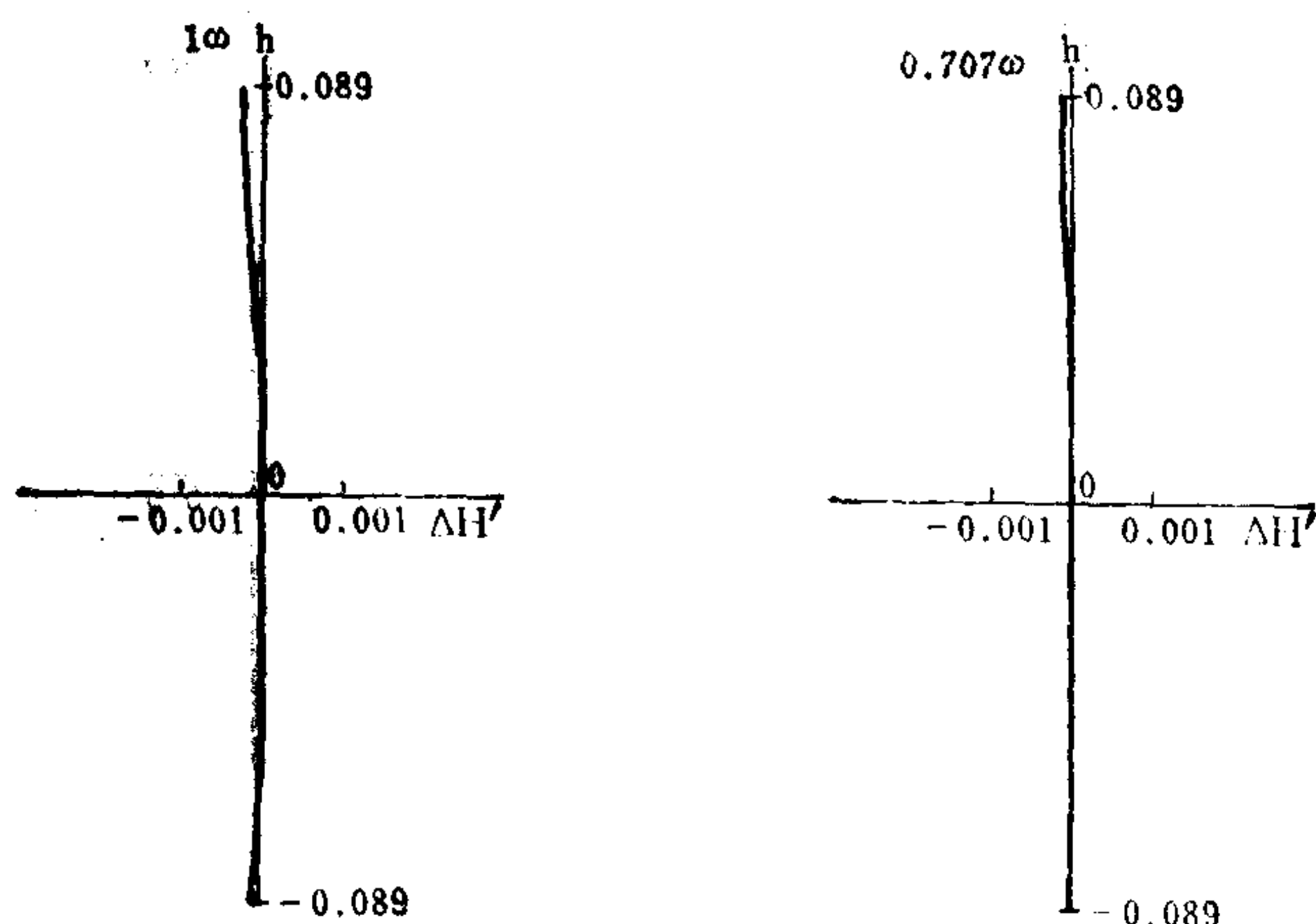
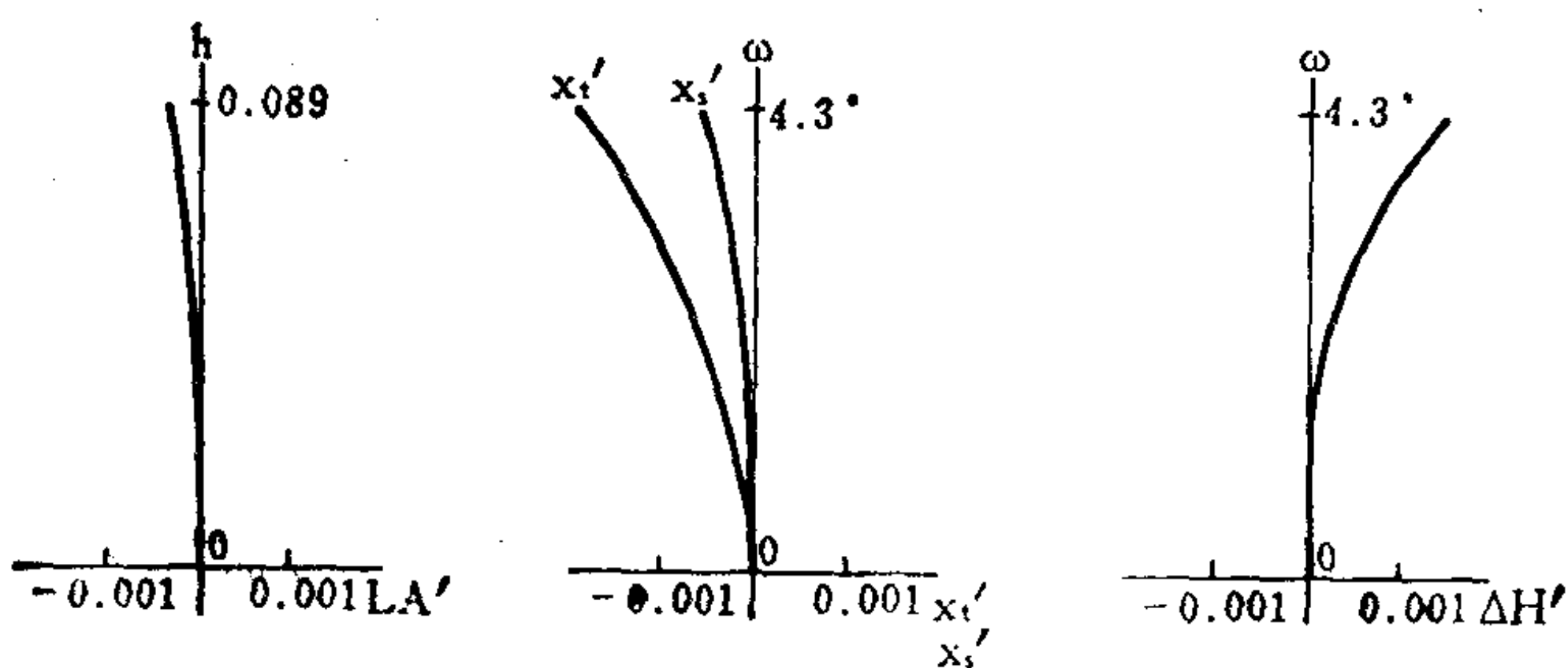

编号: 07-04-090

高斯型物镜

E.F.L=98.78

B.F.L=72.09

FNo.=3.46

F.A.=±24.75°

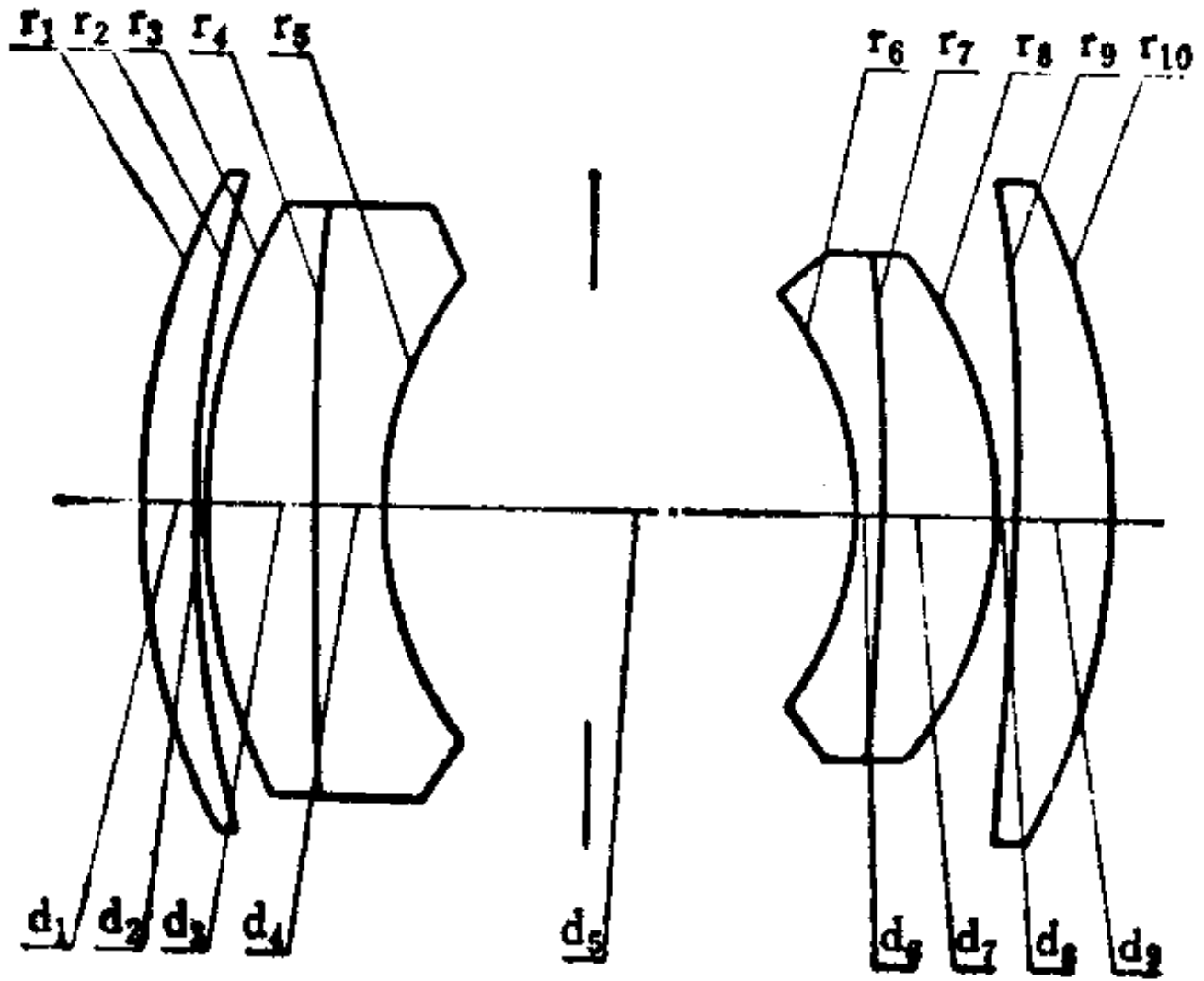

序号	r	d	n	v	序号	r	d	n	v
1	39.575	5.34	1.71300	53.9	6	-19.270	1.21	1.74950	35.1
2	81.415	0.21			7	-273.960	6.50	1.62012	49.6
3	37.442	6.38	1.72000	43.7	8	-24.243	0.20		
4	143.390	3.98	1.64769	33.8	9	-232.870	5.99	1.71700	47.9
5	22.470	27.42*			10	-40.403			

27.42* = 14.00 + 13.42

	ΣS_1	ΣS_2	ΣS_3	ΣS_4	ΣS_5	HI	QP(1 ω)
	-0.0304	0.0017	0.0062	-0.0421	0.0485	45.5	0.3%
h 或 ω %	LA'	$\Delta H'$	x'_t	x'_s	$x'_t - x'_s$	K'_{11}	$K'_{T0.7}$
100	0.0054	0.143	-0.397	-0.235	-0.162	-0.02015	-0.01811
70	-0.2072	0.059	-0.219	-0.288	0.069	0.00353	-0.00216

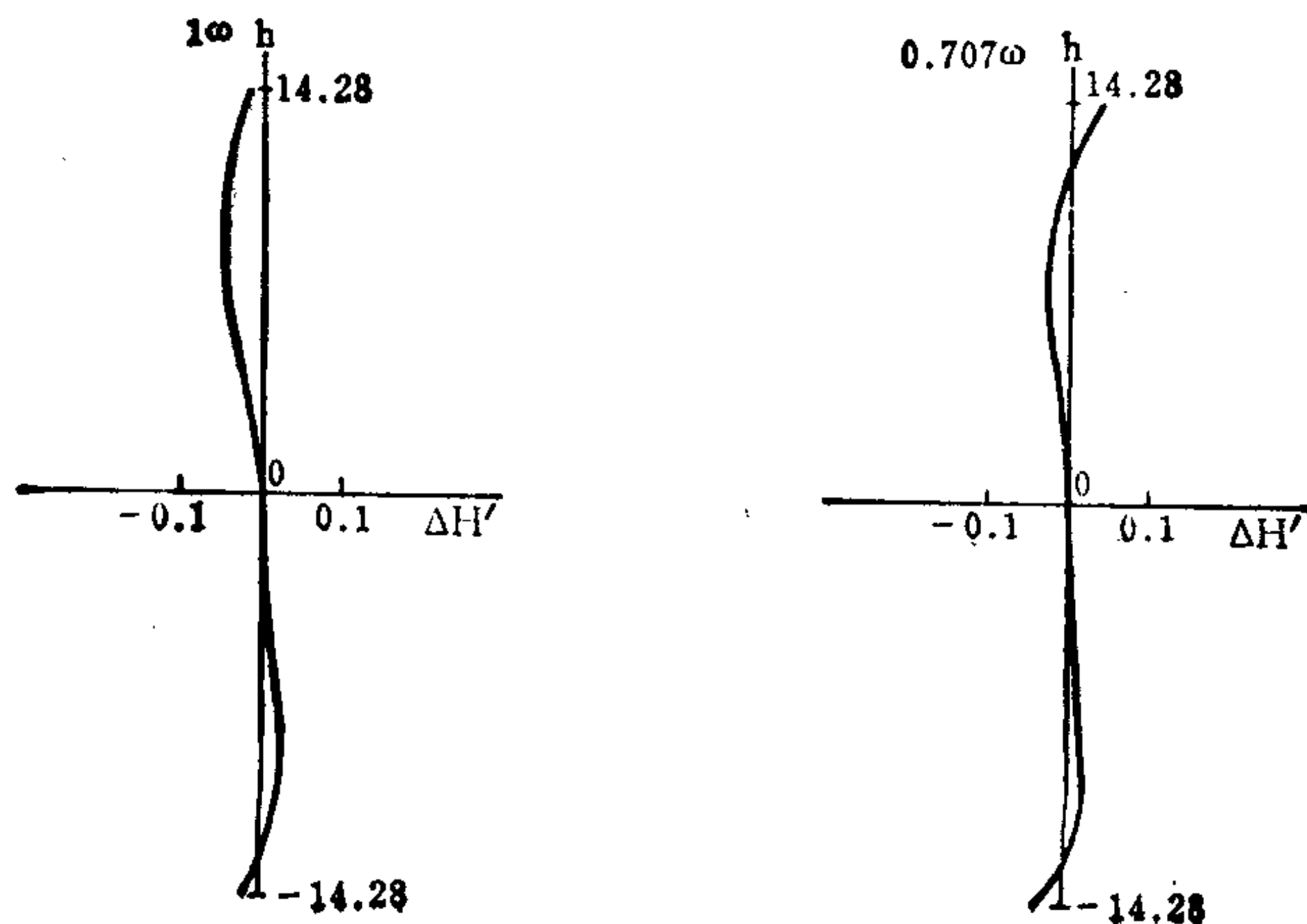
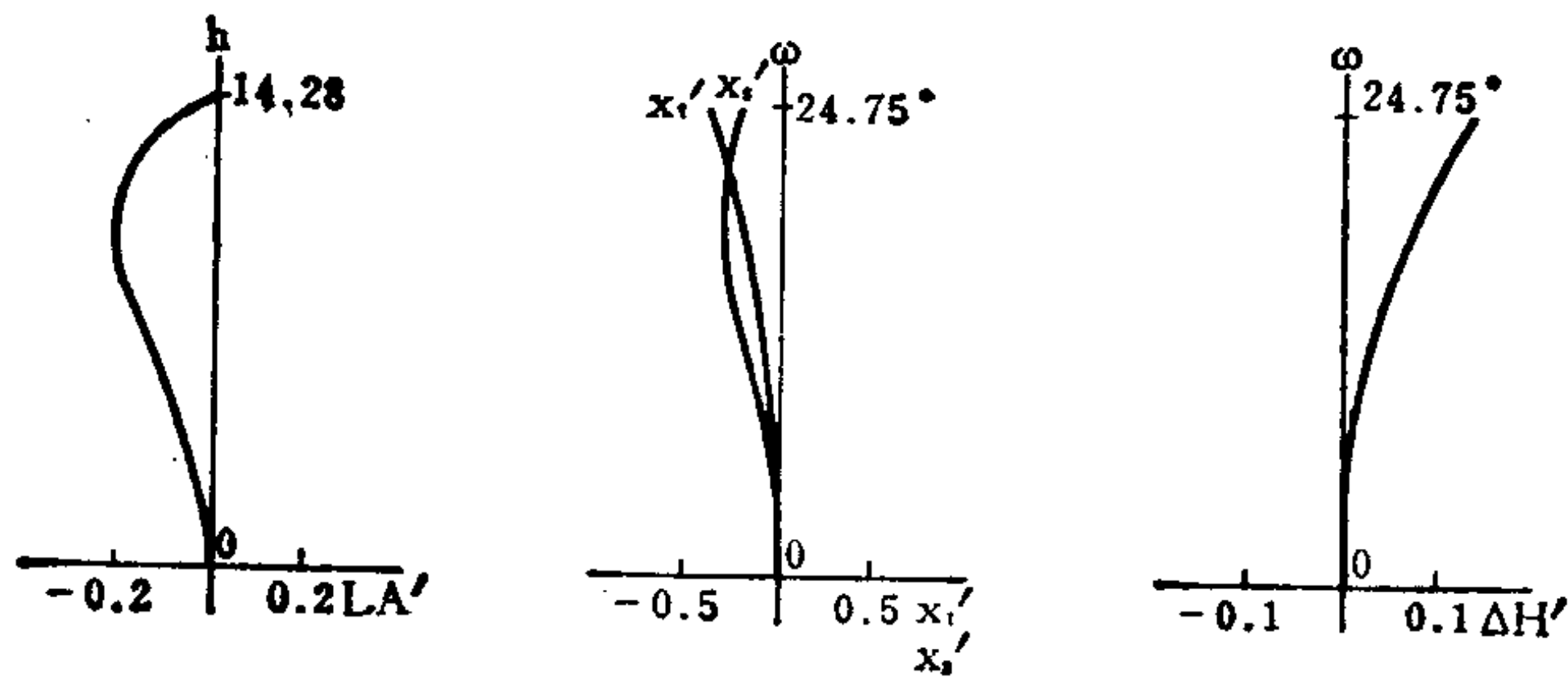

编号: 07-04-091

高斯型放大制版物镜

E.F.L=100

B.F.L=59

FNo.=3.5

F.A.=±25°

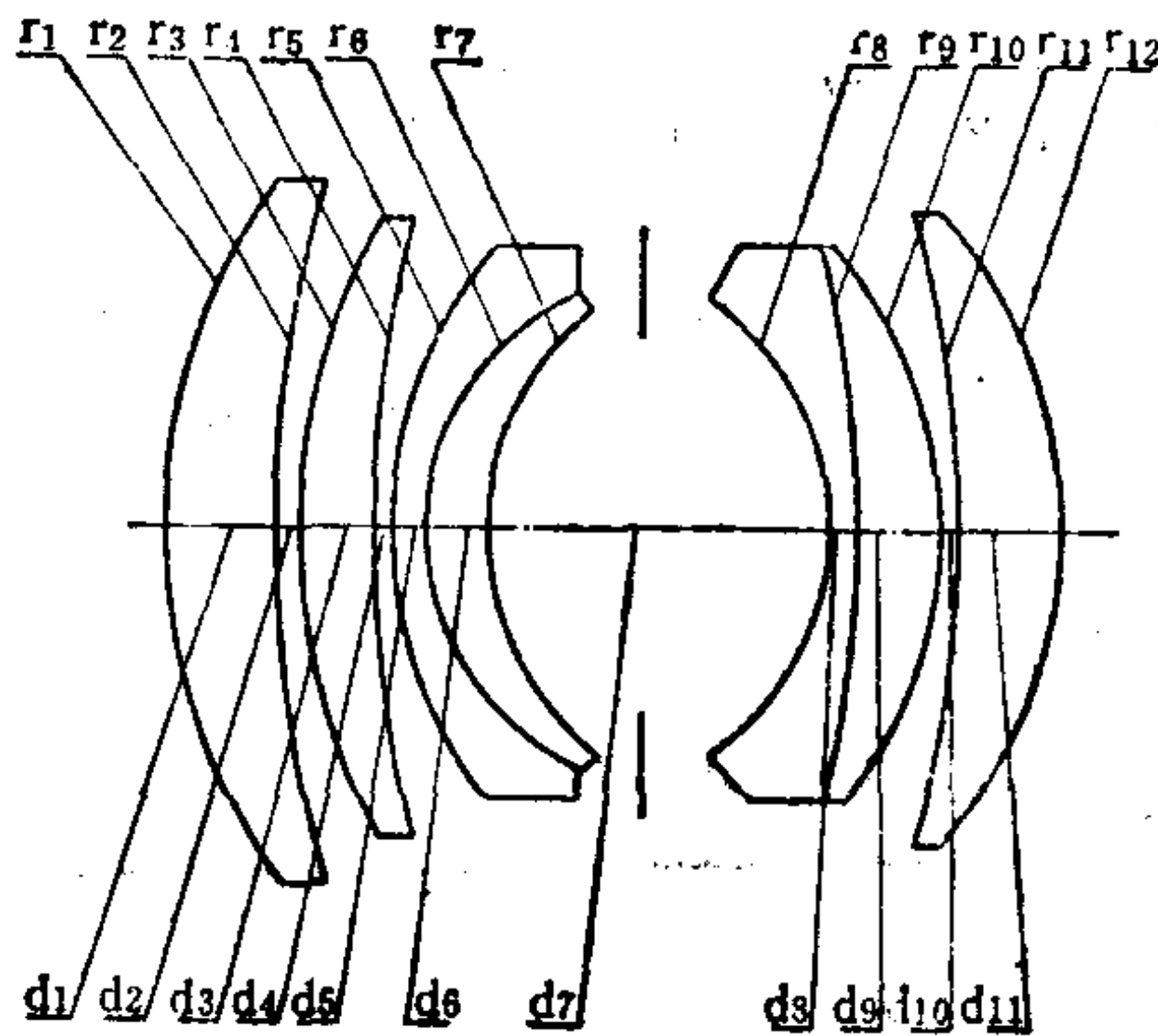

序号	r	d	n	v	序号	r	d	n	v
1	42.015	8.00	1.5687	63.2	7	19.960	23.67*		
2	90.339	1.33			8	-19.456	2.00	1.7400	31.7
3	47.244	5.67	1.5687	63.2	9	-100.159	6.67	1.6860	49.2
4	97.570	0.40			10	-29.407	0.27		
5	31.282	2.27	1.5927	35.3	11	-82.624	7.47	1.7570	47.9
6	18.893	3.87	1.6700	57.3	12	-35.199			

23.67* = 12.00 + 11.67

	ΣS_1	ΣS_2	ΣS_3	ΣS_4	ΣS_5	HI	QP(1 ω)
	0.0272	-0.0542	-0.1476	-0.0399	0.9008	46.7	10.3%
h 或 ω %	LA'	$\Delta H'$	x'_t	x'_s	$x'_t - x'_s$	K'_{T1}	$K'_{T0.7}$
100	1.0748	4.810	-22.122	-6.292	-15.830	0.2104	0.0655
70	0.4259	1.319	-8.677	-2.886	-5.791	-0.2093	-0.1090

注: 1. 以上象差值是按 $l = -\infty$, $d_2 = 1.33$ 计算的。
2. $M = 4^{\times}$ (NA = 0.029, $d_2 = 1.33$) $\sim 8^{\times}$ ($d_2 = 0.20$)。

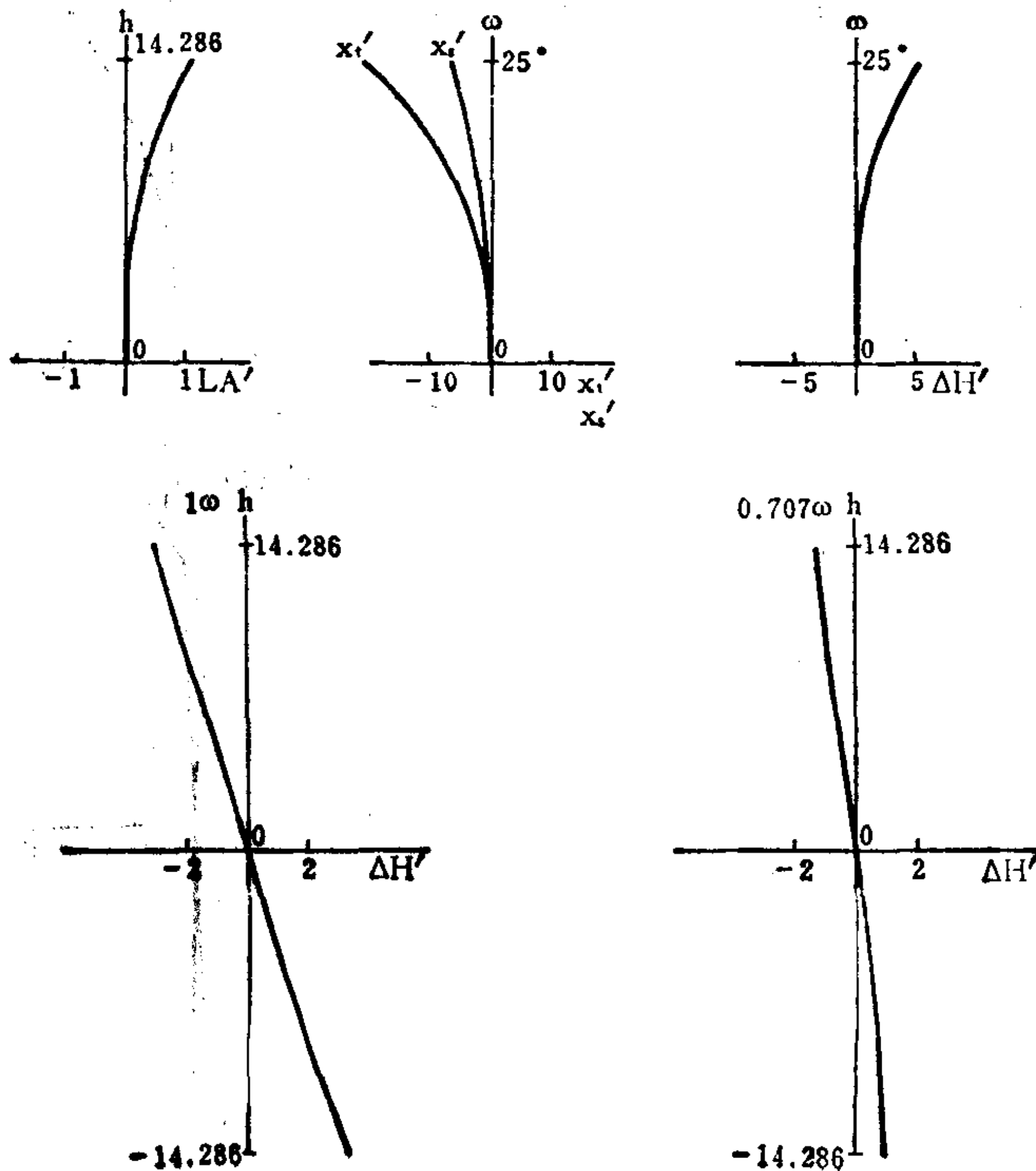

编号: 07-04-092

高斯型放大制版物镜

E.F.L = 100

B.F.L = 59.6

FNo. = 3.5

F.A. = ±25°

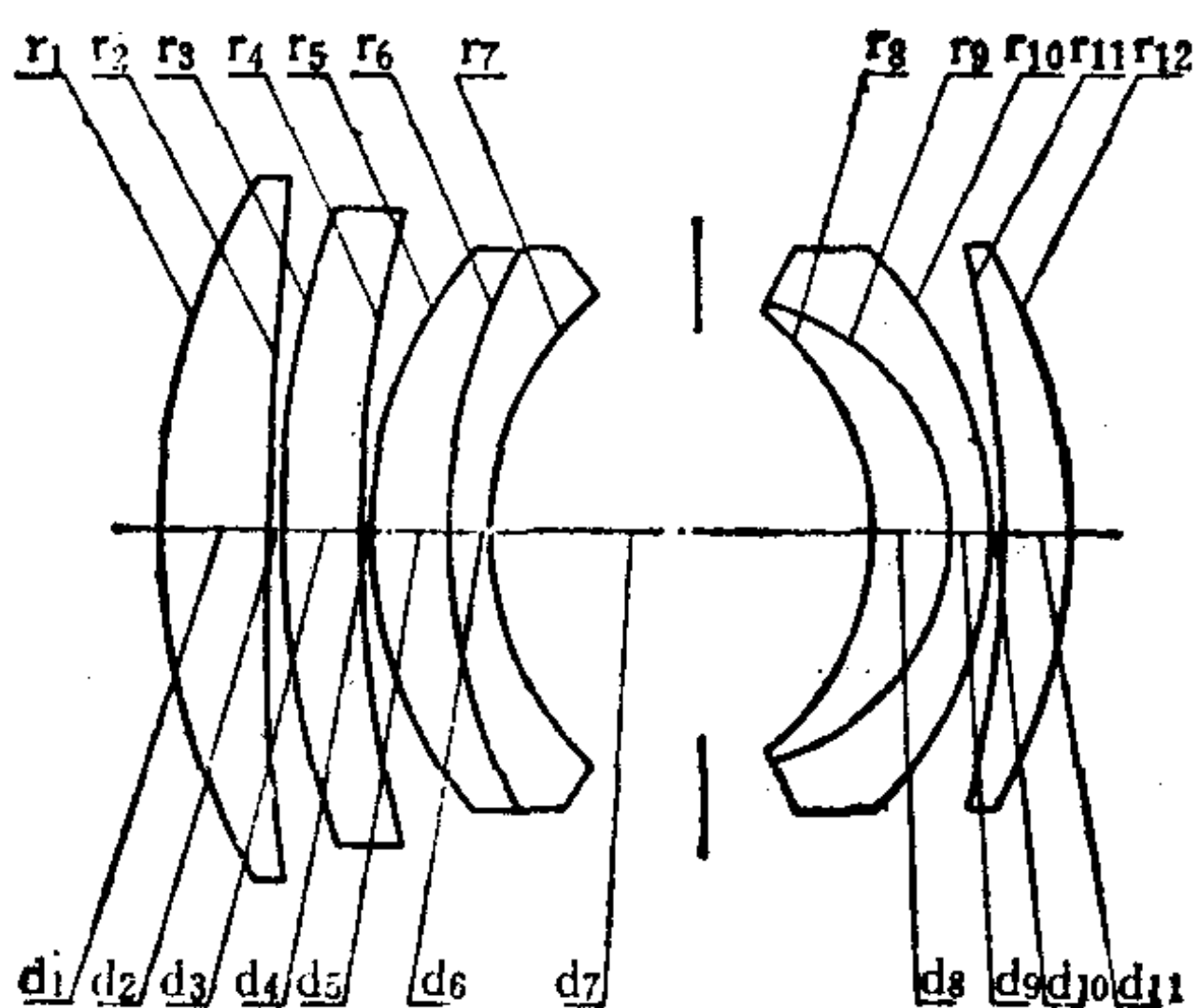

序号	r	d	n	v	序号	r	d	n	v
1	53.068	6.750	1.6584	50.9	7	22.441	26.326*		
2	273.055	0.338			8	-19.531	5.400	1.6400	60.3
3	65.320	5.400	1.6584	50.9	9	-16.537	2.363	1.5927	35.3
4	68.942	0.338			10	-28.173	0.338		
5	31.127	5.400	1.6700	57.3	11	-90.903	8.775	1.7432	49.4
6	44.587	2.700	1.7408	27.8	12	-39.143			

26.326* = 14.000 + 12.326

	ΣS_1	ΣS_2	ΣS_3	ΣS_4	ΣS_5	HI	QP(1 ω)
	0.0196	-0.0430	-0.1777	-0.0489	1.1137	46.6	13.8%
h 或 ω %	LA'	$\Delta H'$	x'_t	x'_s	$x'_t - x'_s$	K'_{T1}	$K'_{10.7}$
100	0.8318	6.436	-32.568	-8.513	-24.055	0.7829	0.3537
70	0.3197	1.587	-11.143	-3.615	-7.528	-0.4373	-0.0239

注: 1. 以上象差值是按 $l = -\infty$, $d_2 = 0.338$ 计算的。

2. 改变 d_2 , 实现 $M = 4^*$ ($NA = 0.029$) $\sim 8^*$ 。

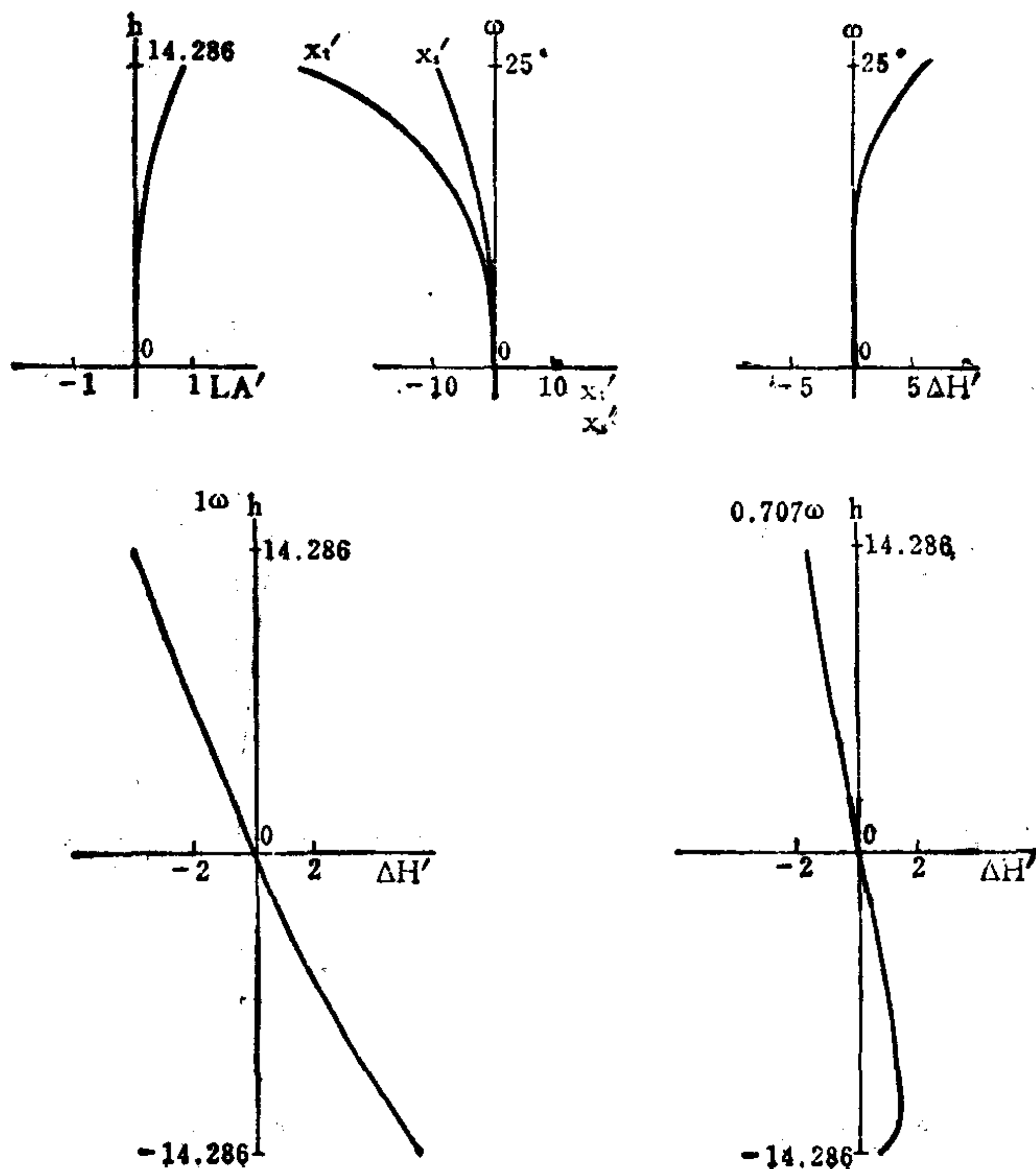

编号: 07-04-093

精 缩 镜 头

E.F.L=1

B.F.L=0.5925

FNo.=4

F.A. = ± 20° **

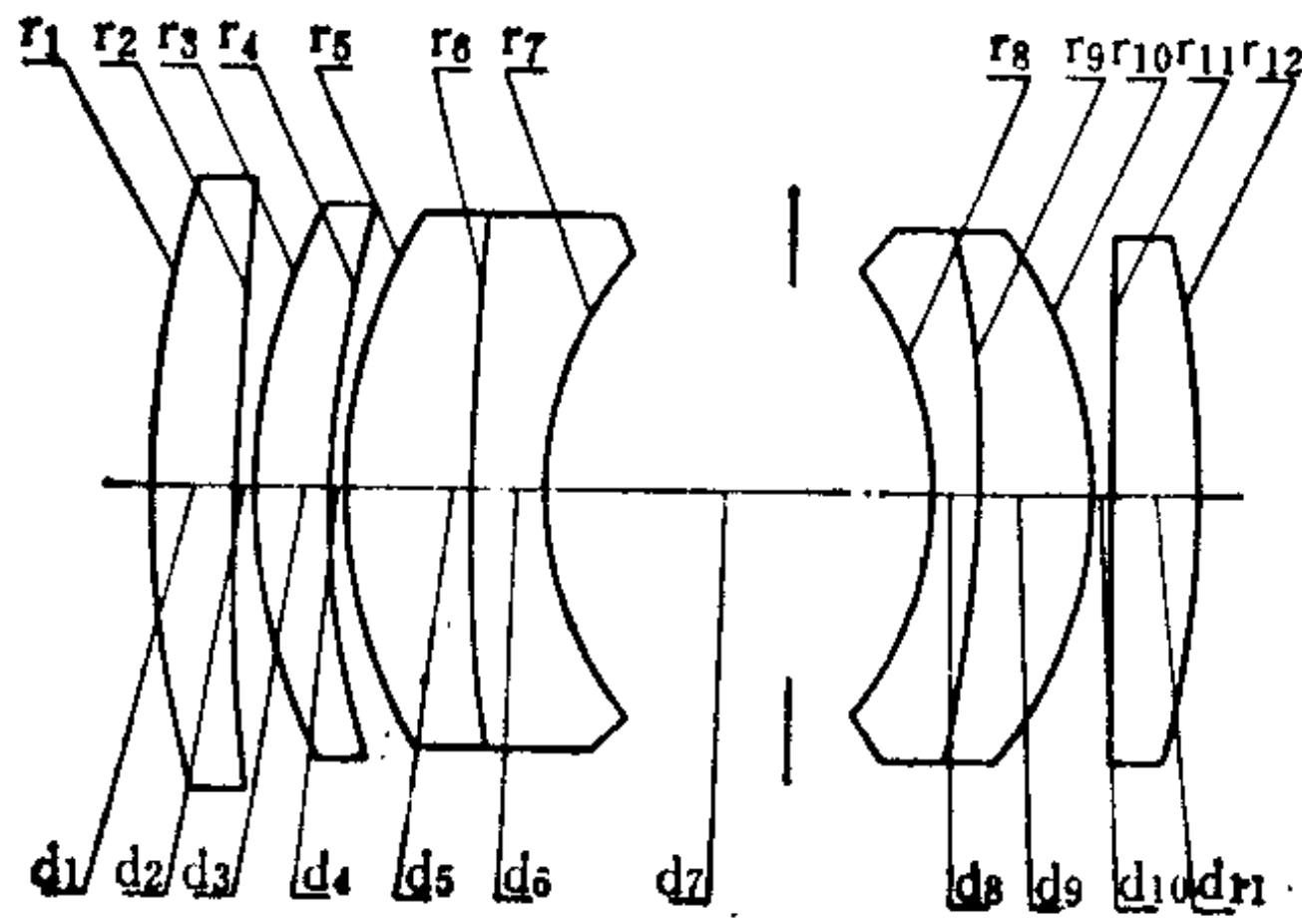

序号	r	d	n	v	序号	r	d	n	v
1	0.9668	0.0587	1.73740	51.45	7	0.2365	0.2847*		
2	1.3048	0.0016			8	-0.2340	0.0333	1.67158	33.04
3	0.4666	0.0587	1.73740	51.45	9	-0.8524	0.0754	1.73740	51.45
4	0.8057	0.0015			10	-0.3125	0.0110		
5	0.4029	0.0924	1.73740	51.45	11	∞	0.0654	1.73740	51.45
6	1.5107	0.0414	1.65223	33.80	12	-0.7376			

0.2847* = 0.1424 + 0.1423

	ΣS ₁	ΣS ₂	ΣS ₃	ΣS ₄	ΣS ₅	HI	QP(1ω)
	0.000004	-0.000075	-0.000033	-0.000093	0.000847	0.36	0.89%
h 或 ω %	LA'	ΔH'	x _i '	x _s '	x _i ' - x _s '	K _{T1}	K _{T0.7}
100	0.00110	0.00326	-0.00089	0.00202	-0.00291	-0.000975	-0.000486
70	0.00030	0.00121	-0.00230	-0.00080	-0.00150	-0.000689	-0.000337

注: 1. 以上象差值是按 $l = -\infty$ 计算的。
 2. 在 $M = (1/7) \times (E.F.L = 120)$ 时, 分辨率为 350 线对/毫米。

