

编译者说明

由于电子工业和电影、电视、照相等事业的飞速发展，近年来，我国在光学镜头设计及加工方面取得了很大进展。成系列的各类镜头已被设计和试制出来，有些并已进入成批生产阶段。但在品种、数量和质量方面，跟世界先进水平相比，差距还是比较大。

近年来，我们收集了美、英、德、日等国从 1811 年到现在的光学镜头资料共 3000 多种。现挑选其中的一部分经补充整理之后，将其出版，以供我国从事光学镜头设计的人员参考。

原资料中，大部分没有给出象差曲线图，我们均重新计算给予补上。由于原资料的光栏位置大多没有给出，我们计算时只能根据我们主观给定的光栏位置进行计算，因此相应的象差曲线图仅供参考。

本册的内容为中等视场中等孔径物镜。

由于我们水平有限，时间仓促，力量不足，所以只能一部分一部分地整理出版，而且在整理编译过程中，一定存在不少缺点和错误，分类也可能不完全合理，望读者批评指正。

本册的部分内容是由春光同志翻译的。参加本册编译工作的有林茂智、杨甦田等同志。

编译者

目 录

符号说明	1
重显透镜系统	2
对称复制透镜系统	3
对称复制透镜系统	4
摄影物镜	5
摄影物镜	6
摄影物镜	7
卡塞格伦型折反射透镜系统	8
卡塞格伦型折反射透镜系统	9
对称三组元照相复印装置透镜系统	10
高斯型摄影物镜	11
改进的物镜系统	12
远距离照相物镜	13
显微照相物镜	14
四片型摄影物镜	15
校正了球差、象散、色差的对称型摄影及重显透镜系统	16
三片型投影透镜系统	17
三片型投影透镜系统	18
物镜	19
物镜	20
三组元物镜	21
对称四组元摄影复印系统	22
对于无限远和 1:1 光学放大率之间的大变化的物距上, 有 一个近似不变的高性能图象的四组元物镜	23
对于无限远和 1:1 光学放大率之间的大变化的物距上, 有 一个近似不变的高性能图象的四组元物镜	24
摄影物镜	25
带有后光栏的摄影物镜	26
带有后光栏的摄影物镜	27
逆聚焦型透镜系统	28
逆聚焦型透镜系统	29
袖珍四片型摄影物镜	30

袖珍四片型摄影物镜	31
远距离照相镜头	32
小倍率超远距离照相镜头	33
塑料及玻璃的袖珍四片型物镜	34
塑料及玻璃的袖珍四片型物镜	35
精密透镜系统	36
精密透镜系统	37
小倍率远距离照相镜头	38
小倍率远距离照相镜头	39
远距离照相镜头	40
消色差远距离物镜	41
消色差远距离物镜	42
小倍率望远镜式远摄透镜系统	43
大孔径长焦距透镜系统	44
大孔径长焦距透镜系统	45
五片型重显物镜	46
五片型重显物镜	47
低折射率玻璃材料的三片型工业电视镜头	48
广角袖珍投影透镜系统	49
低折射率玻璃材料的四片型工业电视镜头	50
复印机聚焦透镜系统	51
袖珍四片型物镜	52
五组元物镜	53
三片型工业电视镜头	54
逆聚焦型广角摄影物镜	55
校正了球差、象散、色差的对称型摄影及重显透镜系统	56
三片型工业电视镜头	57
短焦距摄影及投影物镜	58
分裂式达格型对称复制透镜系统	59
远距离照相镜头	60
三组元重显物镜	61
大视场透镜系统	62
大视场透镜系统	63
逆聚焦型透镜系统	64
二级光谱较小的三透镜物镜	65
用于近紫外的透镜系统	66
大孔径远距离照相镜头	67
大孔径远距离照相镜头	68

长焦距透镜系统	69
长焦距透镜系统	70
复消色差的对称广角物镜	71
复消色差的对称广角物镜	72
五组元摄影物镜	73
五组元摄影物镜	74
四组元照相物镜	75
四组元物镜	76
三组四片投影透镜系统	77
三组四片投影透镜系统	78
低色差透镜系统	79
低色差透镜系统	80
远距离照相镜头	81
三组元物镜	82
三组元物镜	83
倒置的高斯型对称复印透镜系统	84
四组元对称投影物镜	85
大倍率远摄照相镜头	86
大倍率远摄照相镜头	87
四组元摄影物镜	88
四组元摄影物镜	89
四组元高斯型摄影物镜	90
四组元高斯型摄影物镜	91
四片型对称重显物镜	92
由两组相对复消色差透镜组成的远摄光学系统	93
三片型望远物镜	94
三片型望远物镜	95
小倍率望远镜式远摄透镜系统	96
对称投影物镜	97
三片型摄影物镜	98
二级光谱较小三组元透镜系统	99
远摄物镜	100
远摄物镜	101
高斯型对称物镜	102
光学物镜	103
摄影放大机物镜	104
摄影放大机物镜	105

符号说明

1. 凡数据后有符号“*”，表示光栏位置或其值间有光栏。
凡数据后有符号“**”，表示原资料中未给出 F. A. 值，此系编者在计算时给定的值。

2. 凡没有注明数值单位的，均以毫米为单位；若注明以英寸为单位的，则在该镜头资料中均以英寸为单位。

3. 常用符号：

ΣS_1	球差系数和；
ΣS_2	彗差系数和；
ΣS_3	象散系数和；
ΣS_4	场曲系数和；
ΣS_5	畸变系数和；
LA'	球差；
$\Delta H'$	绝对畸变；
x'_i	细光束子午场曲；
x'_s	细光束弧矢场曲；
$x'_i - x'_s$	象散；
K'_{T1}	全口径的子午彗差；
$K'_{T0.7}$	0.707 口径的子午彗差；
QP	相对畸变；
HI	理想象高；
E. F. L	焦距；
B. F. L	后截距；
FNo.	相对孔径倒数；
F. A.	视场角；
L'_p	入瞳距离或光栏距 L'_p 下标所示面的距离；
η	物高；
ω	镜头视场。

编号: 05-04-001

重显透镜系统

E. F. L = 100

B. F. L = 79.61

FNo. = 5.6

F. A. = ±22.5°

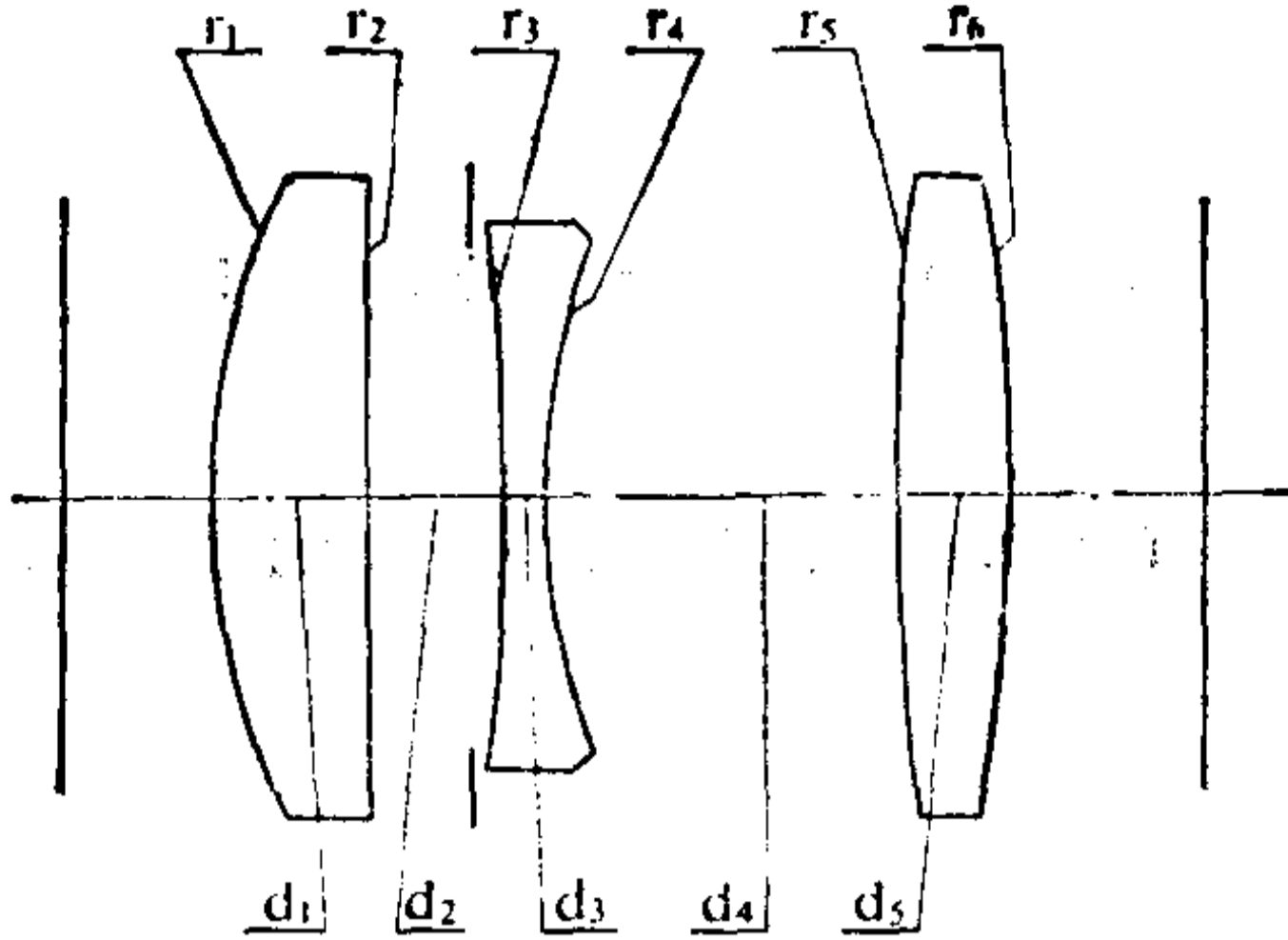

序号	r	d	nd	v	序号	r	d	nd	v
1	25.11	5.14	1.65844	50.8	4	24.54	11.74		
2	2844.42	4.75*			5	142.77	3.88	1.65844	50.8
3	-79.796	1.36	1.66680	33.1	6	-64.56			

4.75* = 3.75 + 1.00

	ΣS_1	ΣS_2	ΣS_3	ΣS_4	ΣS_5	HI	QP (1 ω)
	-0.01010	-0.00667	0.00896	-0.03791	0.01885	41.27	-0.01%
h 或 ω %	LA'	$\Delta H'$	x'_i	x'_e	$x'_i - x'_e$	K'_{T1}	$K'_{T0.7}$
100	-0.320	-0.0041	0.398	-0.073	0.471	0.2790	0.1504
70	-0.248	0.0257	0.021	-0.570	0.591	-0.0229	0.0059

注: 1. M = 2^x ~ 10^x;

2. 以上象差值是按 l = -∞ 计算的。

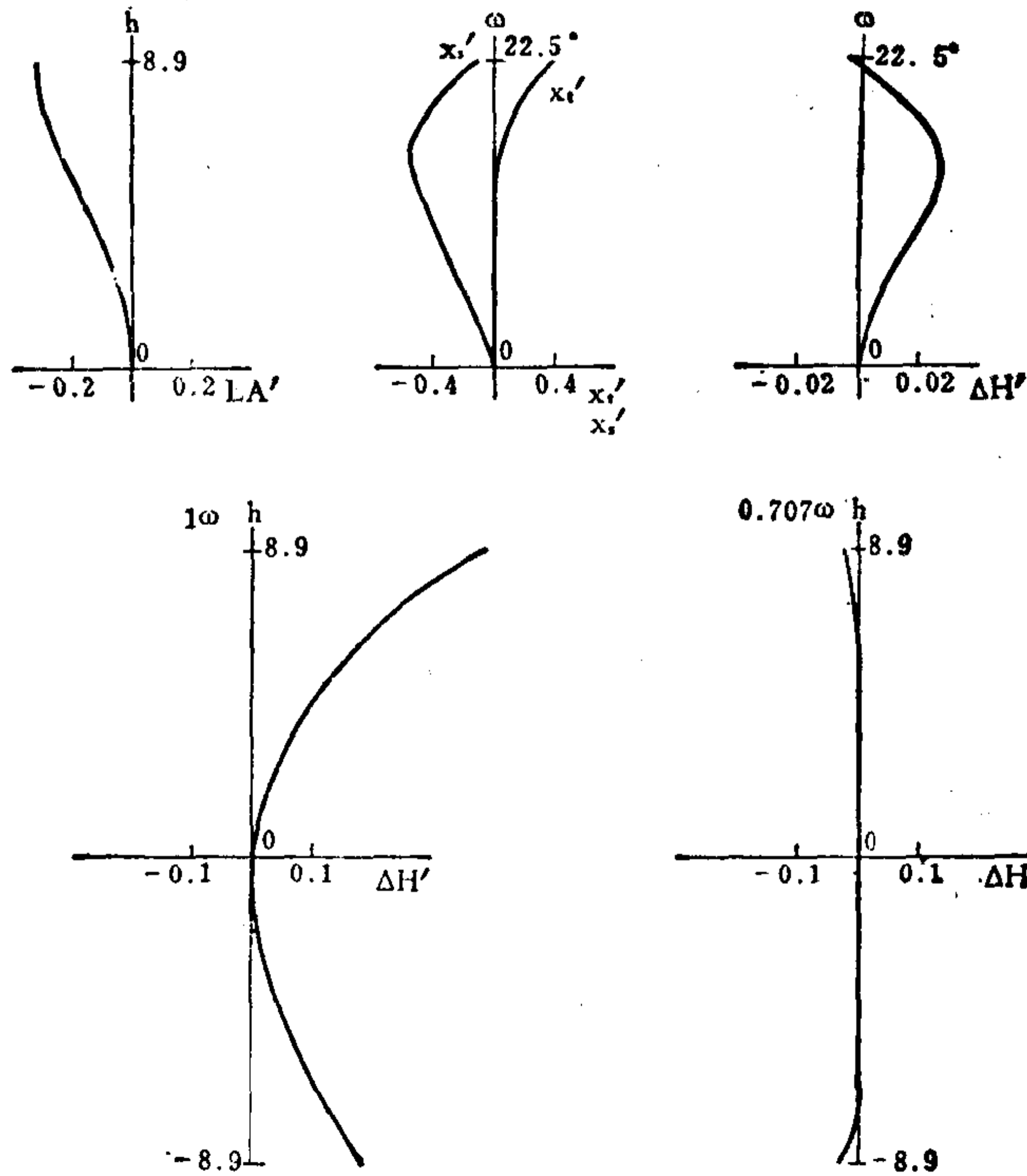

编号: 05-04-002

对称复制透镜系统

E.F.L=0.99

B.F.L=0.78

FNo.=4.5

F.A. = ±25°**

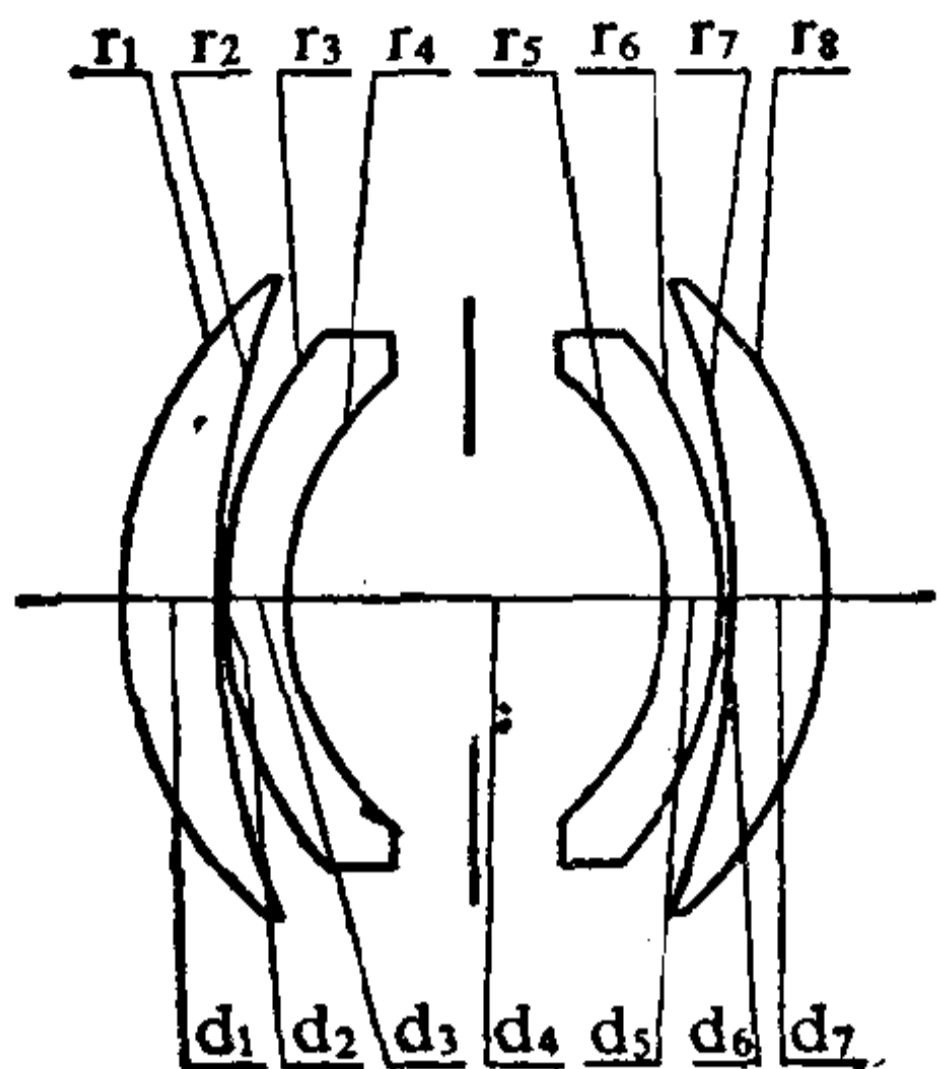

序号	r	d	n _d	v	序号	r	d	n _d	v
1	0.217	0.0480	1.62	60.3	5	-0.147	0.0300	1.72	29.3
2	0.435	0.0004			6	-0.207	0.0004		
3	0.207	0.0300	1.72	29.3	7	-0.435	0.0480	1.62	60.3
4	0.147	0.1900*			8	-0.217			

0.1900* = 0.0950 + 0.0950

	ΣS ₁	ΣS ₂	ΣS ₃	ΣS ₄	ΣS ₅	HI	QP(1ω)
	-0.00034	-0.00025	-0.00004	-0.00025	0.0008	0.4586	1.03%
h 或 ω%	LA'	ΔH'	x' _i	x' _s	x' _i -x' _s	K _{T1}	K' _{T0.7}
100	-0.00039	0.00474	-0.00159	-0.00606	0.00447	-0.00493	-0.00224
70	-0.00388	0.00152	-0.00524	-0.00488	-0.00036	-0.00165	-0.00149

注: 以上象差值是按 l = -∞ 计算的。

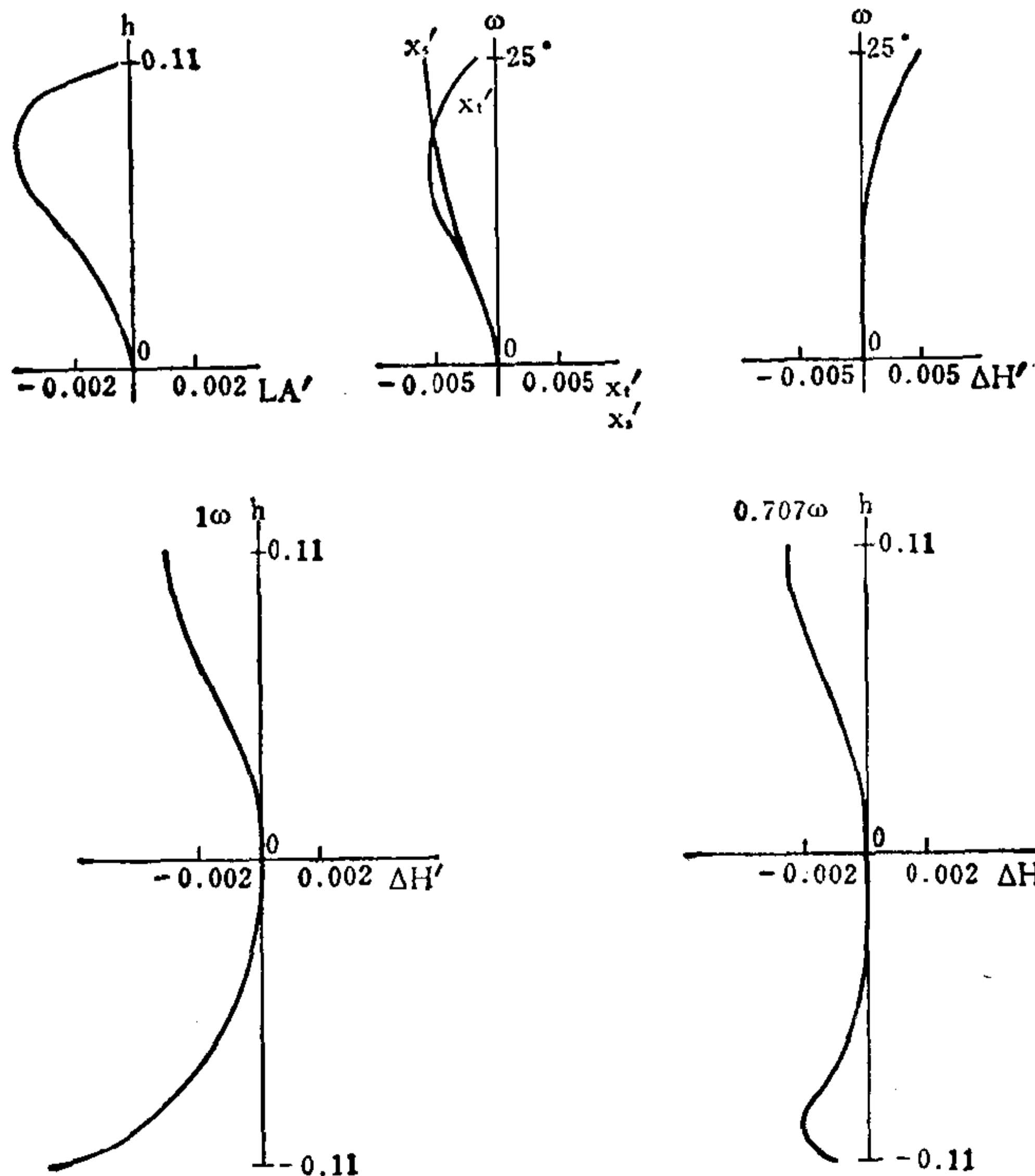

编号: 05-04-003

对称复制透镜系统

E.F.L=1.02

B.F.L=0.82

FNo.=4.5

F.A. = ±25°**

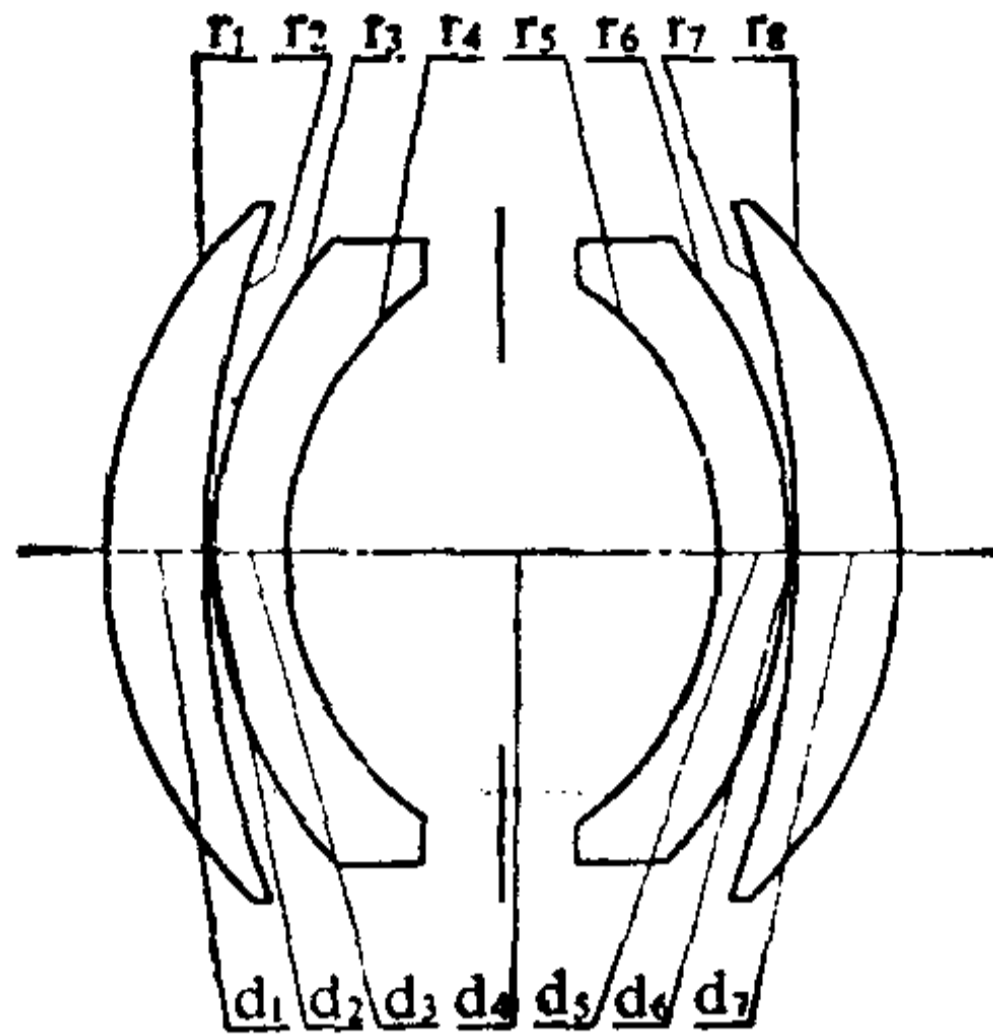

序号	r	d	n_d	v	序号	r	d	n_d	v
1	0.211	0.0460	1.62	60.3	5	-0.143	0.0290	1.72	29.3
2	0.424	0.0005			6	-0.204	0.0005		
3	0.204	0.0290	1.72	29.3	7	-0.424	0.0460	1.62	60.3
4	0.143	0.1860*			8	-0.211			

$0.1860^* = 0.0930 + 0.0930$

	ΣS_1	ΣS_2	ΣS_3	ΣS_4	ΣS_5	HI	QP (1 ω)
	0.000009	-0.000219	-0.000120	-0.000154	0.000736	0.4758	0.94%
h 或 ω %	LA'	$\Delta H'$	x'_i	x'_s	$x'_i - x'_s$	K'_{T1}	$K'_{T0.7}$
100	0.0216	0.0045	-0.0086	-0.0056	-0.0030	-0.00466	-0.00206
70	0.0048	0.0014	-0.0090	-0.0048	-0.0042	-0.00336	-0.00135

注: 以上象差值是按 $l = -\infty$ 计算的。

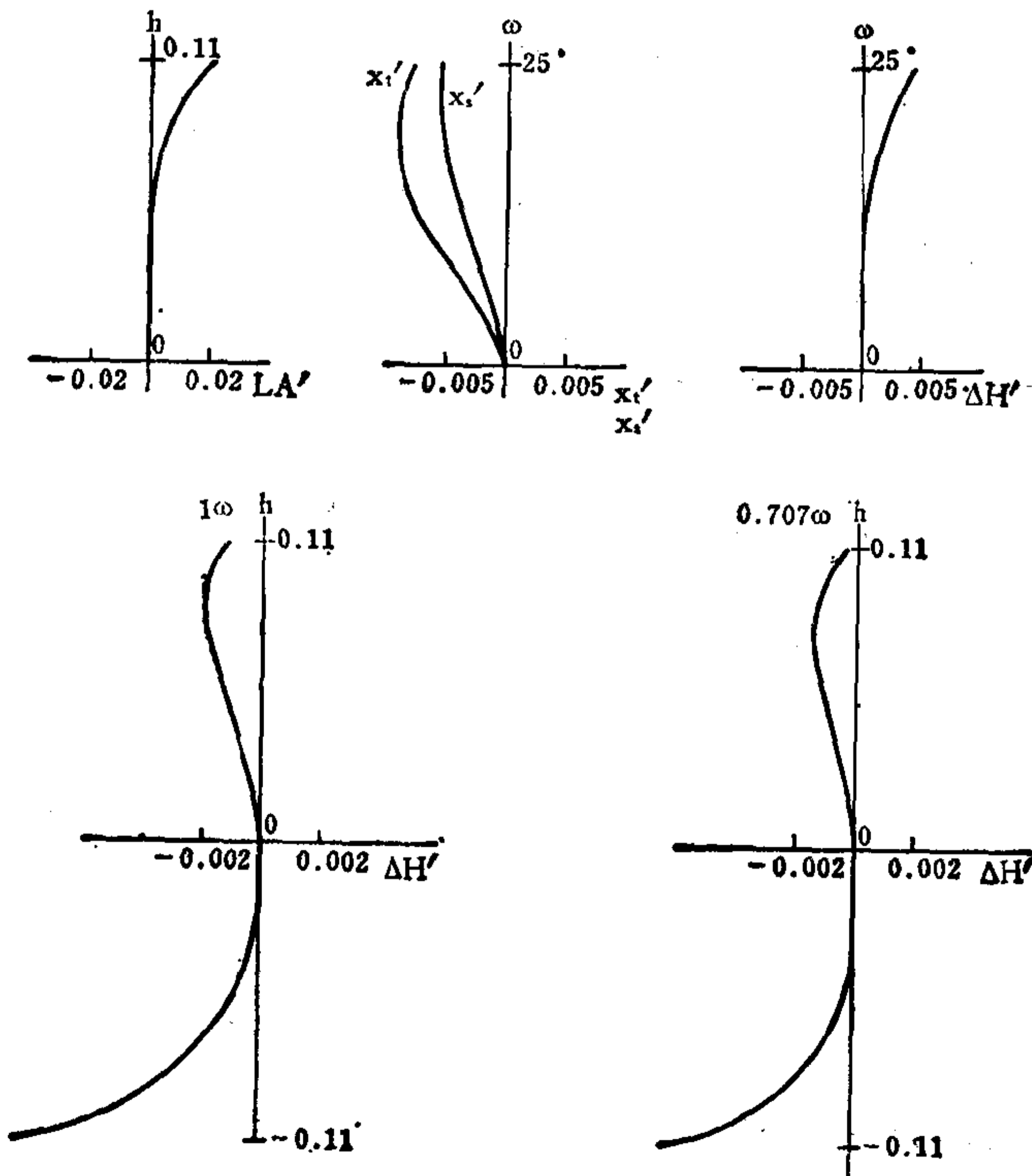

编号: 05-04-004

摄影物镜

E. F. L = 1.0

B. F. L = 0.5555

FNo. = 4

F. A. = $\pm 8^\circ$

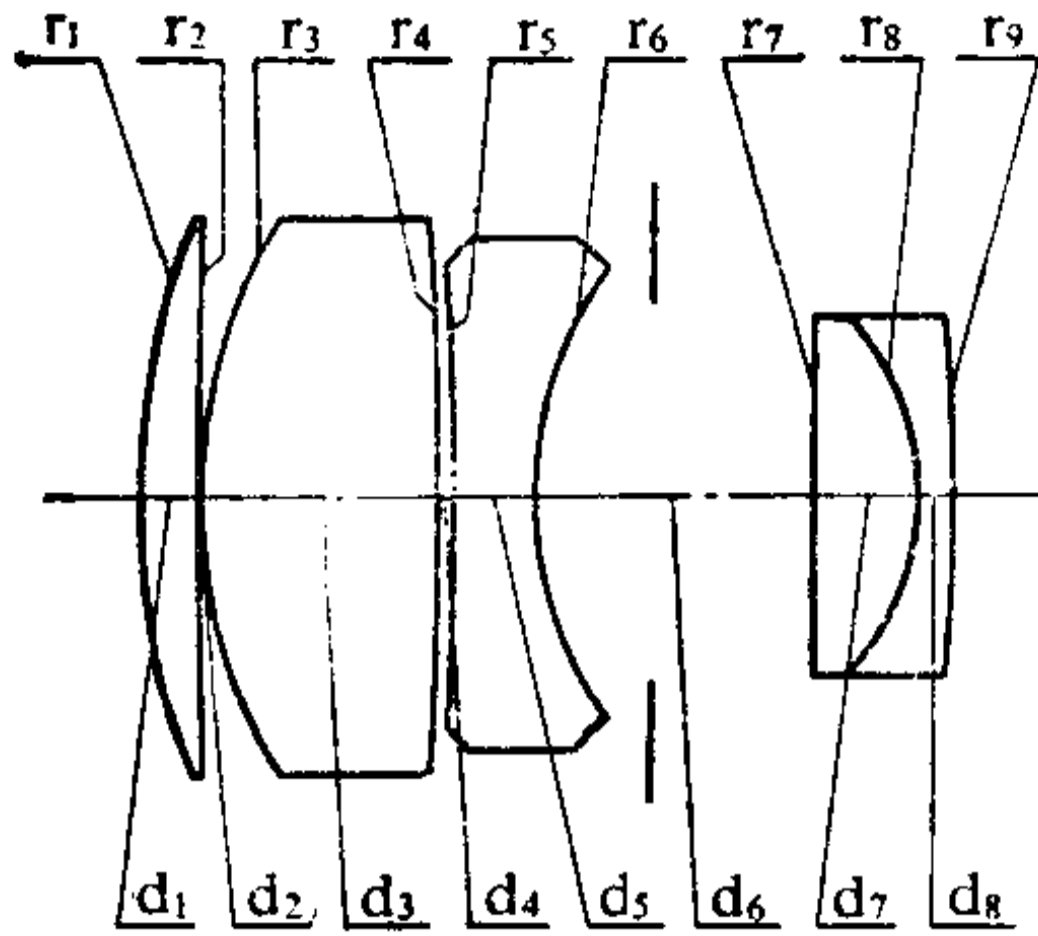

序号	r	d	n _d	v _d	序号	r	d	n _d	v _d
1	0.37371	0.02413	1.62041	60.29	6	0.16813	0.11845*		
2	2.10155	0.00016			7	∞	0.04432	1.56965	49.45
3	0.23750	0.10210	1.48749	70.04	8	-0.11648	0.01477	1.55232	63.49
4	-1.32595	0.00607			9	-1.11563			
5	-1.16431	0.03339	1.66446	35.88					

$0.11845^* = 0.04000 + 0.07845$

	ΣS_1	ΣS_2	ΣS_3	ΣS_4	ΣS_5	HI	QP (1 ω)
	-0.000064	-0.000012	0.000007	-0.000039	0.000377	0.1399	1.13%
h 或 ω %	LA'	$\Delta H'$	x'_t	x'_s	$x'_t - x'_s$	K'_{T1}	$K'_{T0.7}$
100	-0.00033	0.00158	-0.00052	-0.00091	0.00039	0.000410	0.000097
70	-0.00040	0.00055	-0.00027	-0.00049	0.00022	-0.000017	-0.000020

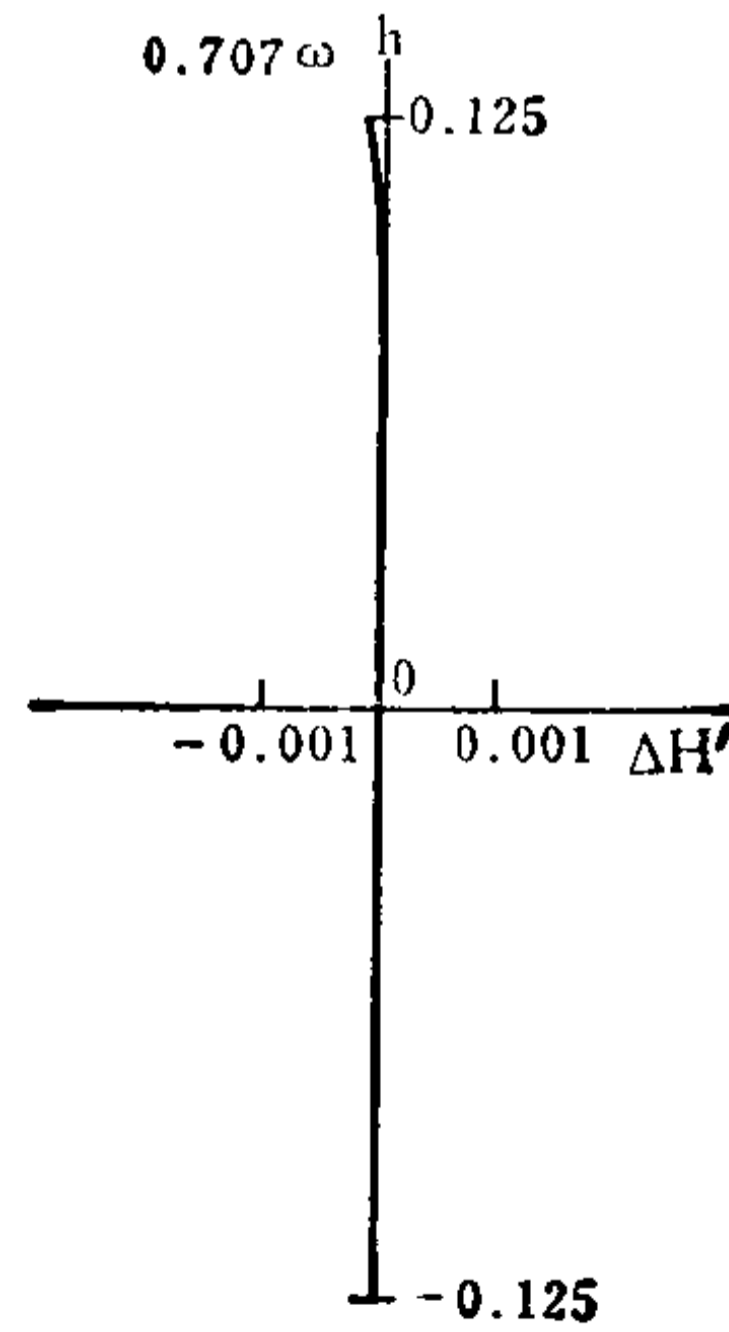
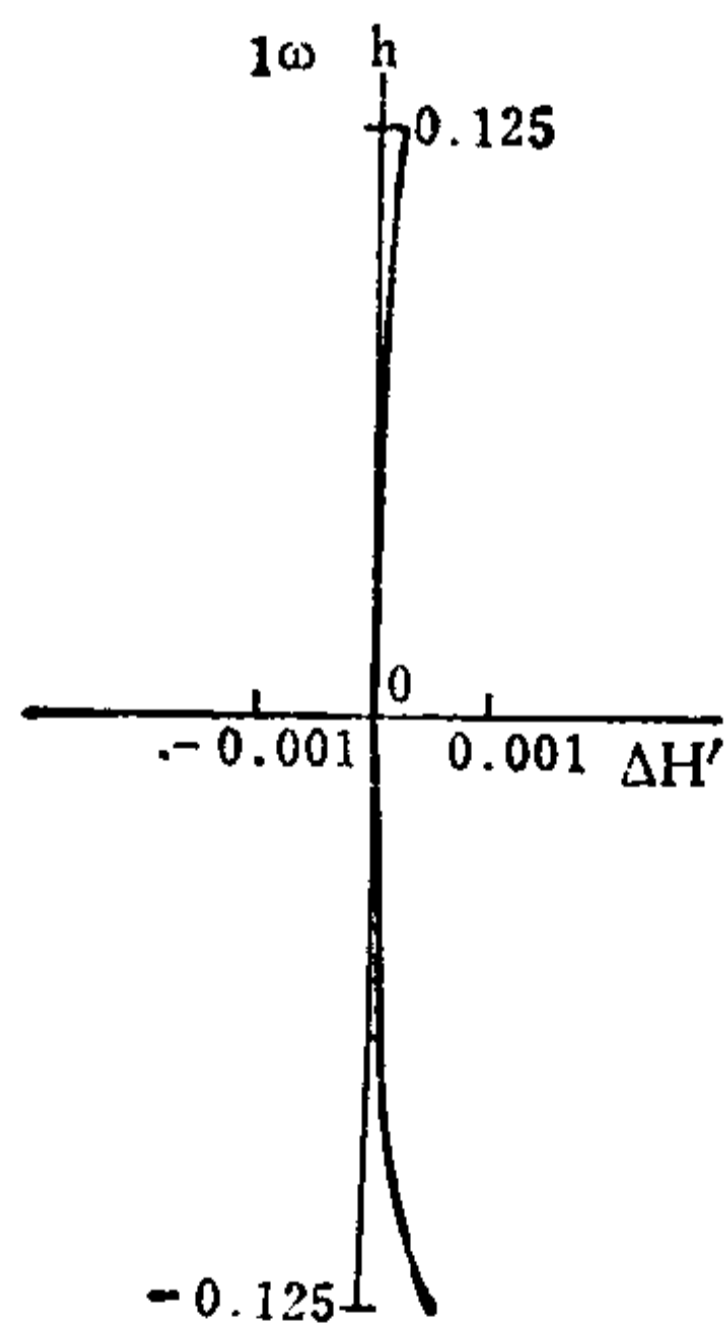
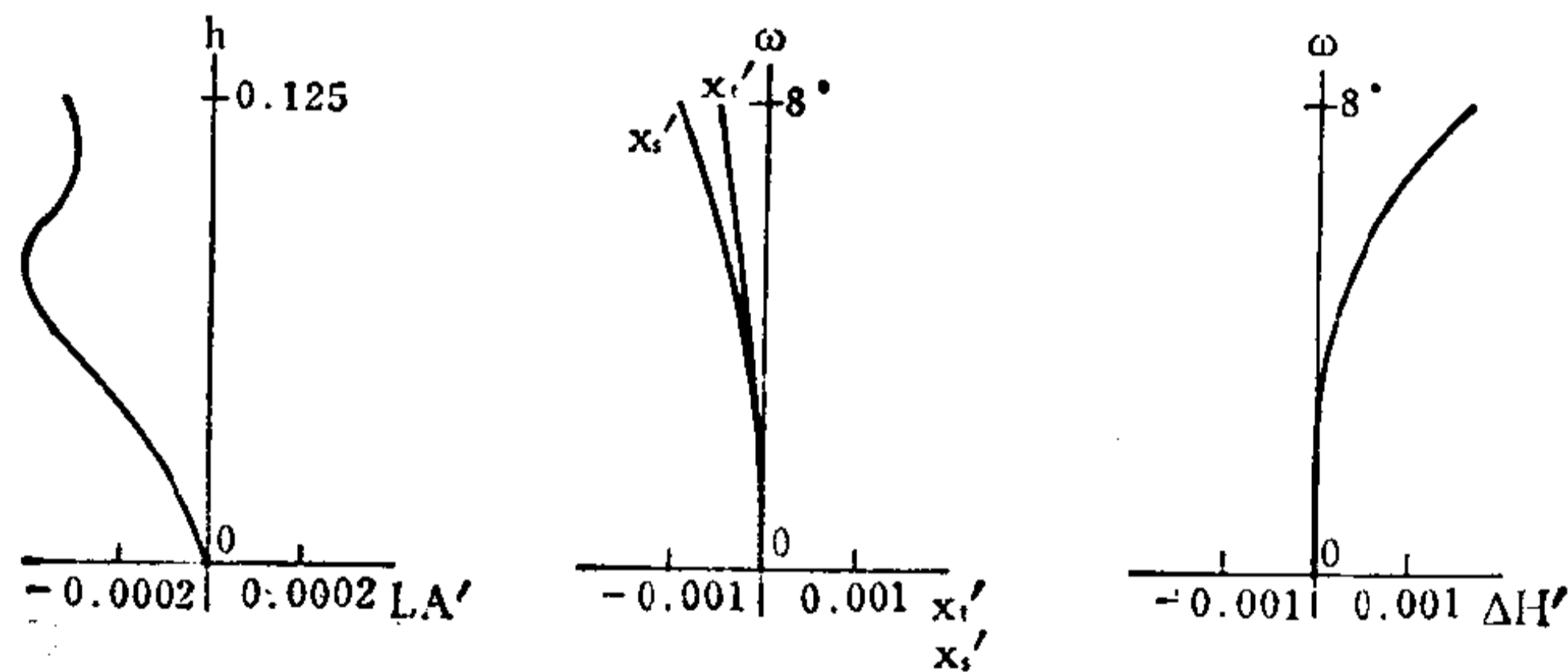

编号: 05-04-005

摄影物镜

E.F.L=1.0

B.F.L=0.56

FNo. = 4

F.A. = ±8°

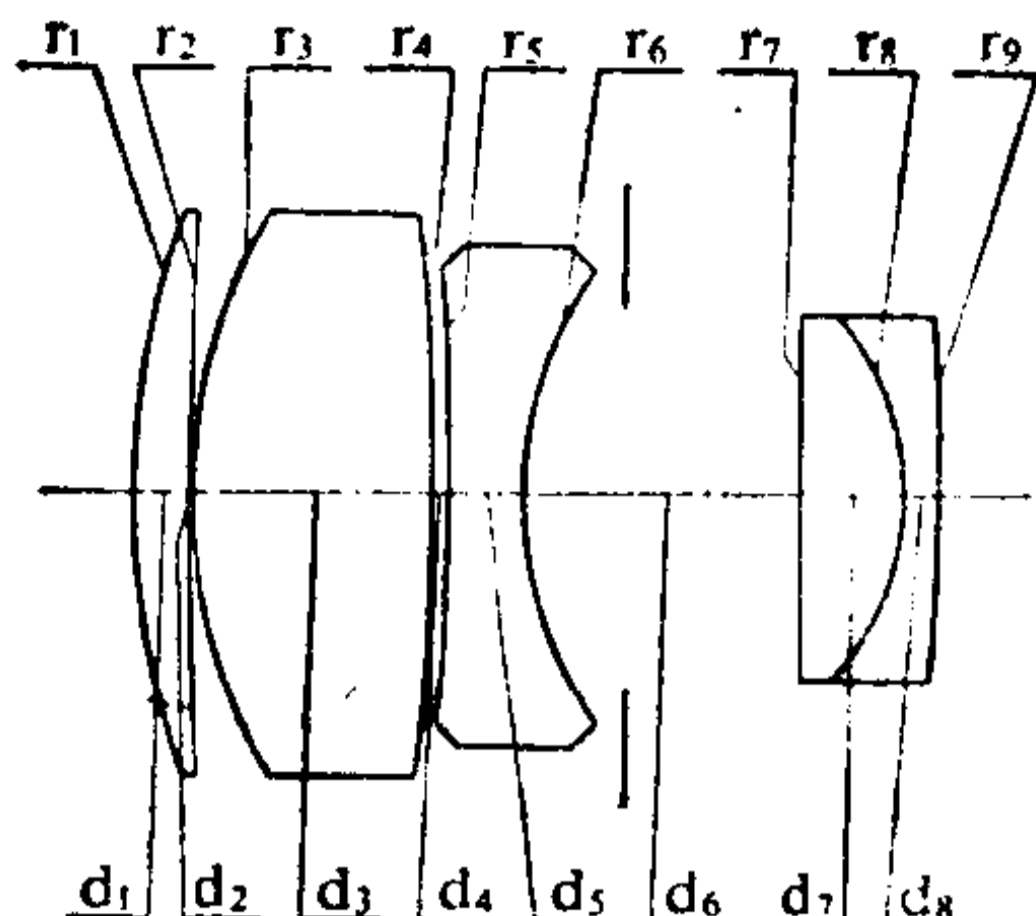

序号	r	d	n_d	v_d	序号	r	d	n_d	v_d
1	0.36712	0.02405	1.62041	60.29	6	0.17245	0.11812*		
2	1.92115	0.00016			7	∞	0.04417	1.56965	49.45
3	0.24535	0.10176	1.48794	70.04	8	-0.12034	0.01472	1.55232	63.49
4	-1.39973	0.00605			9	-1.04970			
5	-1.21222	0.03337	1.66446	35.88					

$0.11812^* = 0.04000 + 0.07812$

	ΣS_1	ΣS_2	ΣS_3	ΣS_4	ΣS_5	HI	QP (1 ω)
	-0.000092	0.000002	0.000006	-0.000050	0.000357	0.1396	1.06%
h 或 ω %	LA'	$\Delta H'$	x'_t	x'_s	$x'_t - x'_s$	K'_{T1}	$K'_{T0.7}$
100	-0.00107	0.00148	-0.00079	-0.00125	0.00046	0.00050	0.00017
70	-0.00086	0.00052	-0.00043	-0.00066	0.00023	0.00011	0.00004

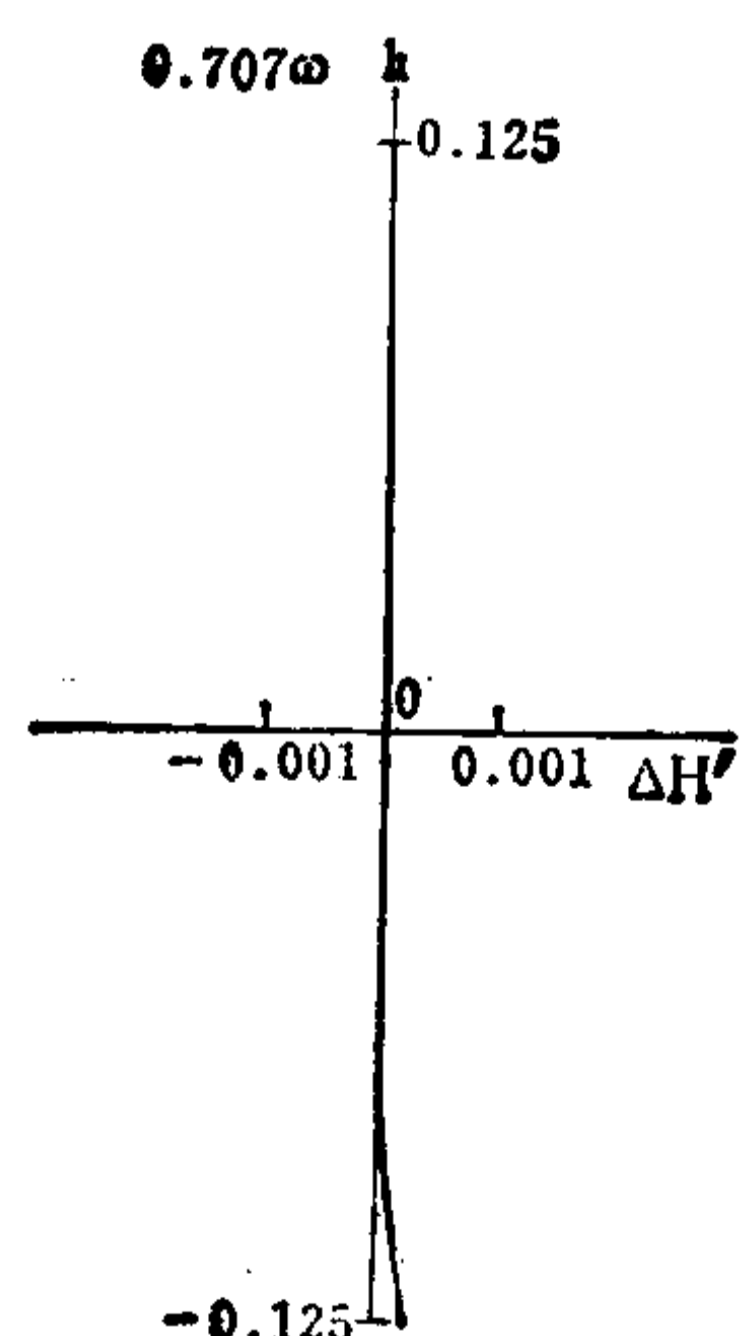
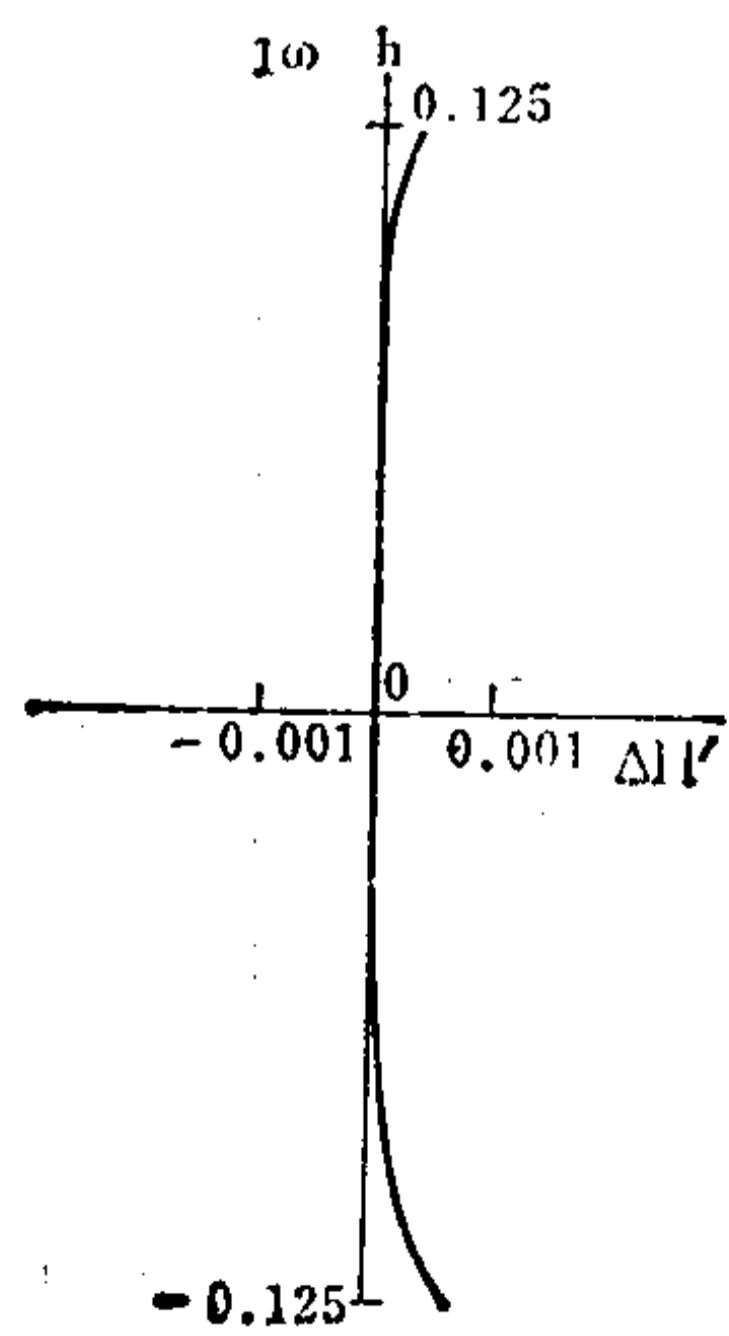
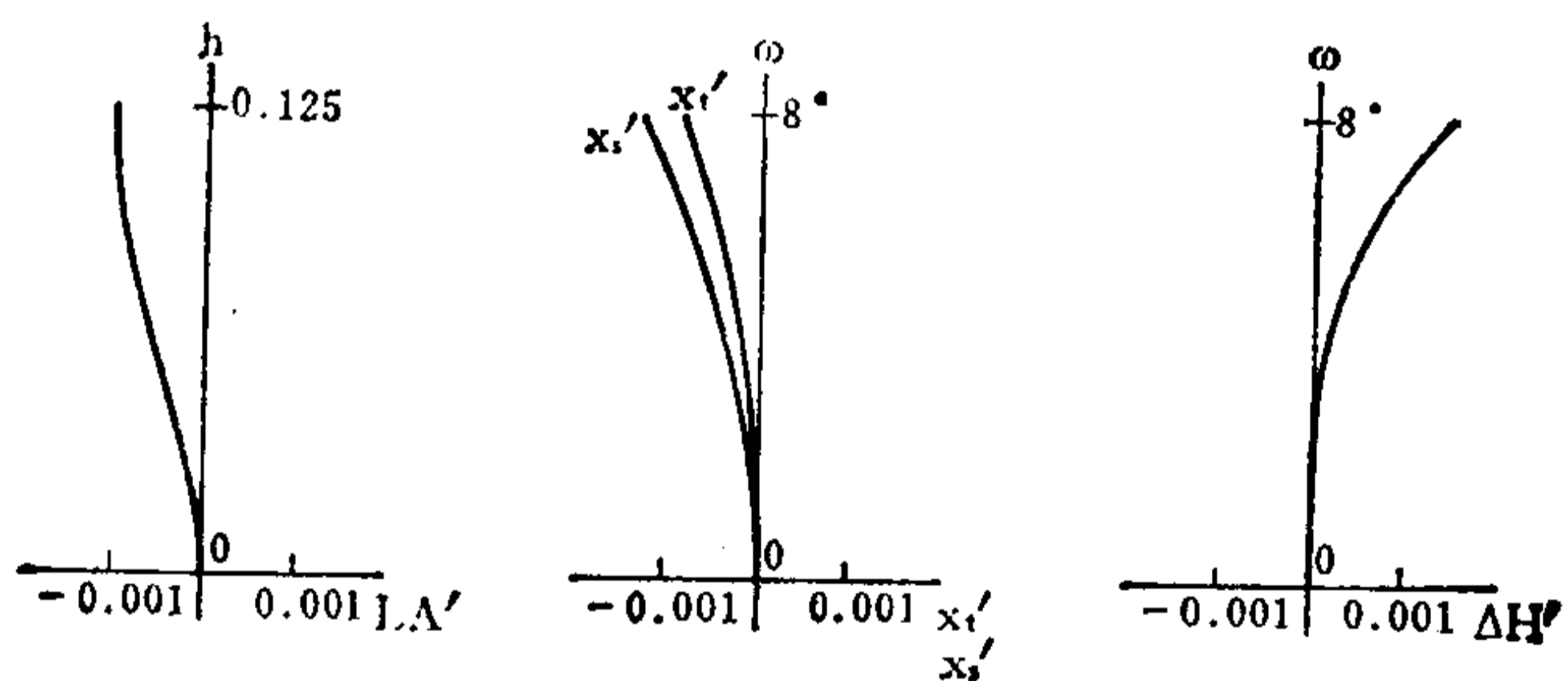

编号: 05-04-006

摄影物镜

E.F.L=1.0

B.F.L=1.127

FNo. = 4

F.A. = ± 36°

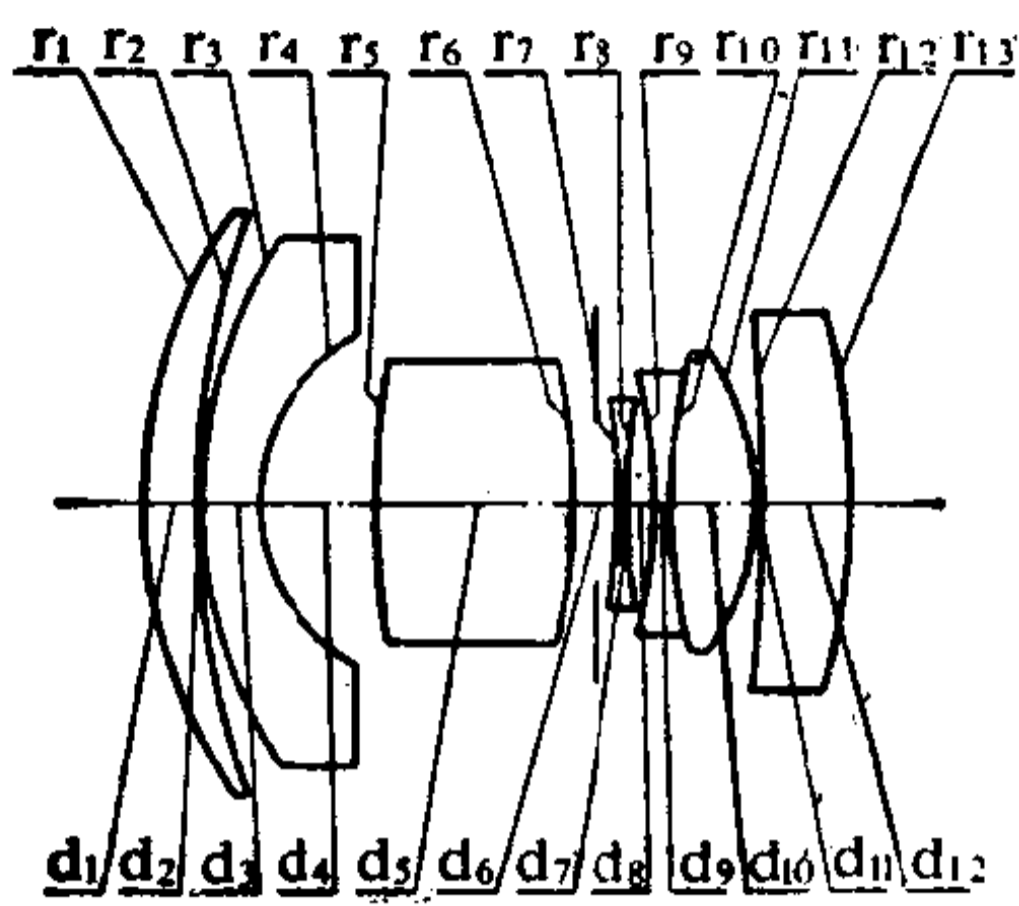

序号	r	d	nd	vd	序号	r	d	nd	vd
1	0.6687	0.0684	1.66755	41.88	8	1.2328	0.0273		
2	1.1066	0.0018			9	-0.6883	0.0227	1.51742	52.16
3	0.6268	0.0755	1.51821	65.18	10	0.7778	0.1089	1.62041	60.29
4	0.2407	0.1516			11	-0.3499	0.0018		
5	1.1472	0.2415	1.66672	48.38	12	-2.8404	0.1178	1.62041	60.29
6	-0.8727	0.0604*			13	-0.9178			
7	-0.7238	0.0187	1.72151	29.28					

0.0604* = 0.0300 + 0.0304

	ΣS_1	ΣS_2	ΣS_3	ΣS_4	ΣS_5	HI	QP (1 ω)
	-0.000419	0.000212	0.000145	-0.001007	-0.003871	0.7253	-1.88%
h 或 ω %	LA'	$\Delta H'$	x'_t	x'_s	$x'_t - x'_s$	K'_{T1}	$K'_{T0.7}$
100	0.00361	-0.0136	-0.0202	0.0156	-0.0358	-0.00399	-0.00106
70	-0.00332	-0.0064	-0.0027	-0.0073	0.0046	-0.00096	-0.00018

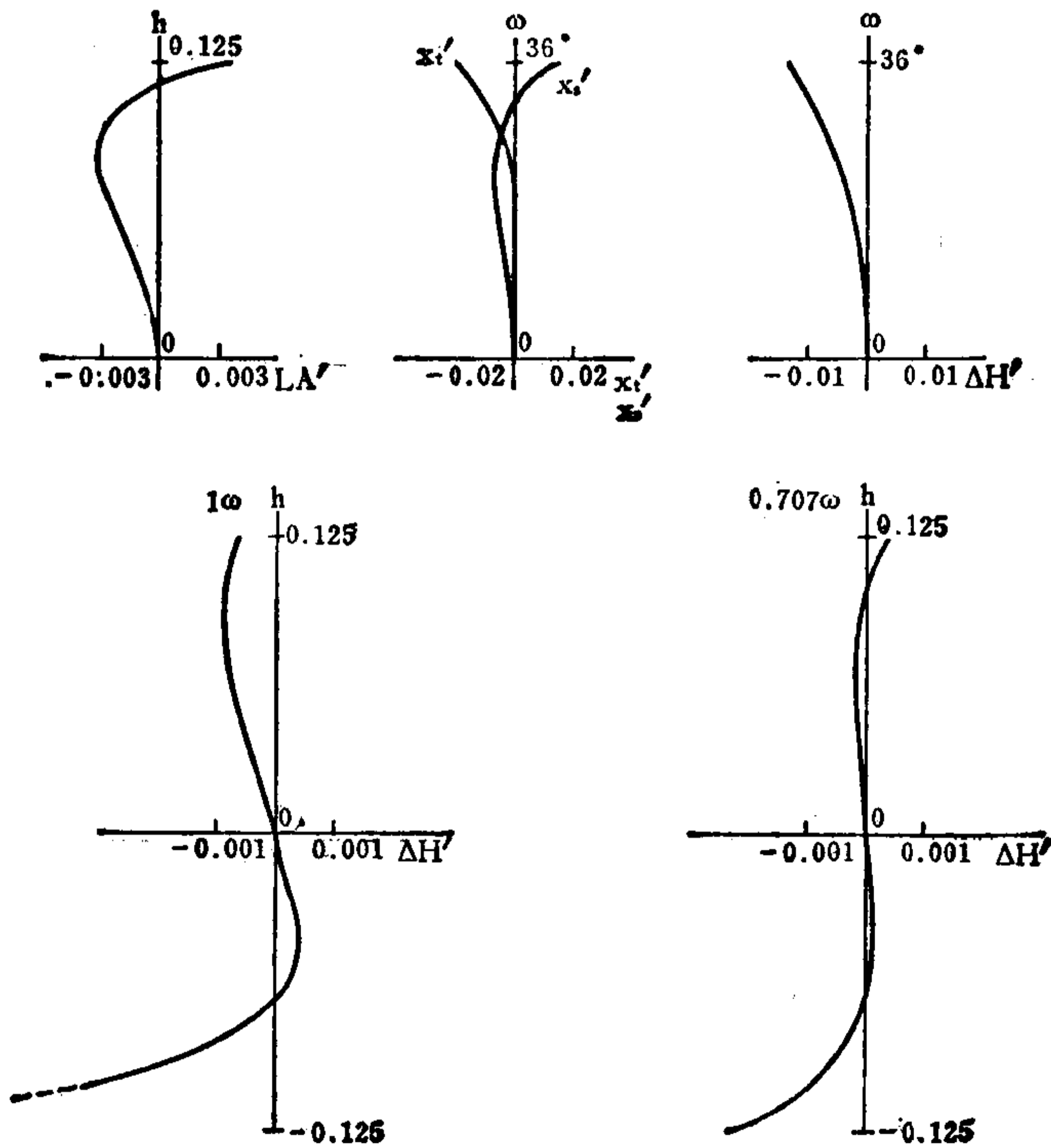

编号: 05-04-007

卡塞格伦型折反射透镜系统

E.F.L=1516 B.F.L=97.16 FNo.=7.96 F.A.=±1° L'p1=0

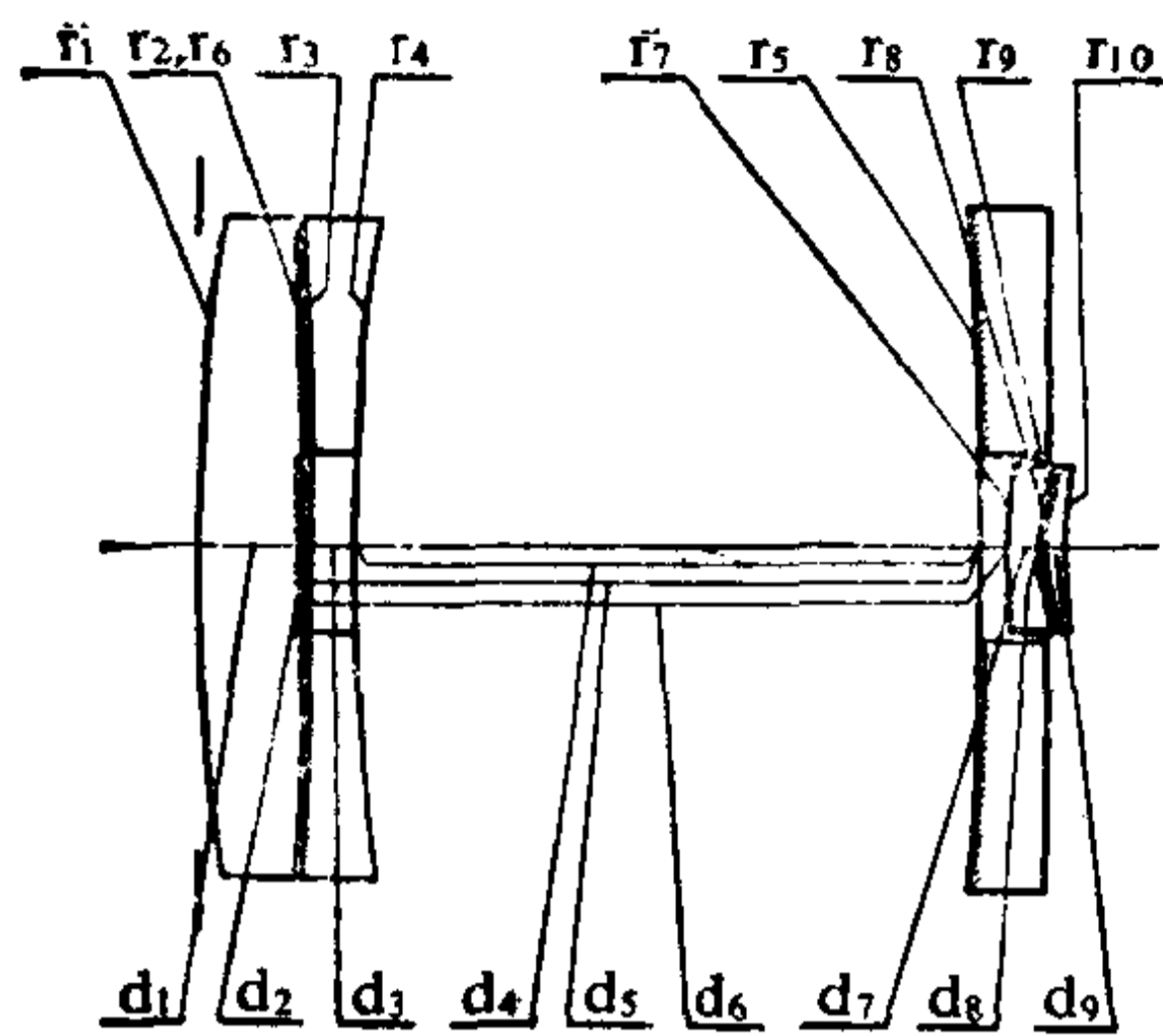

序号	r	d	n	v	序号	r	d	n	v
1	605.59	25.90	1.5168	64.2	6	-1146.29	445.46		
2	-1146.29	1.00			7	195.96	8.20	1.5168	64.2
3	-1018.75	11.50	1.5168	64.2	8	60.91	1.03		
4	634.29	424.27			9	61.51	4.57	1.5168	64.2
5	-1433.83	-435.85	-1.0000		10	151.13			

	ΣS_1	ΣS_2	ΣS_3	ΣS_4	ΣS_5	HI	QP (1 ω)
	-0.00119	0.00289	-0.00233	0.00064	0.00326	26.46	0.097%
h 或 ω %	LA'	$\Delta H'$	x'_t	x'_s	$x'_t - x'_s$	K'_{T1}	$K'_{T0.7}$
100	0.132	0.026	-0.776	-0.203	-0.573	0.0684	0.0349
70	-0.007	0.009	-0.395	-0.104	-0.291	0.0476	0.0243

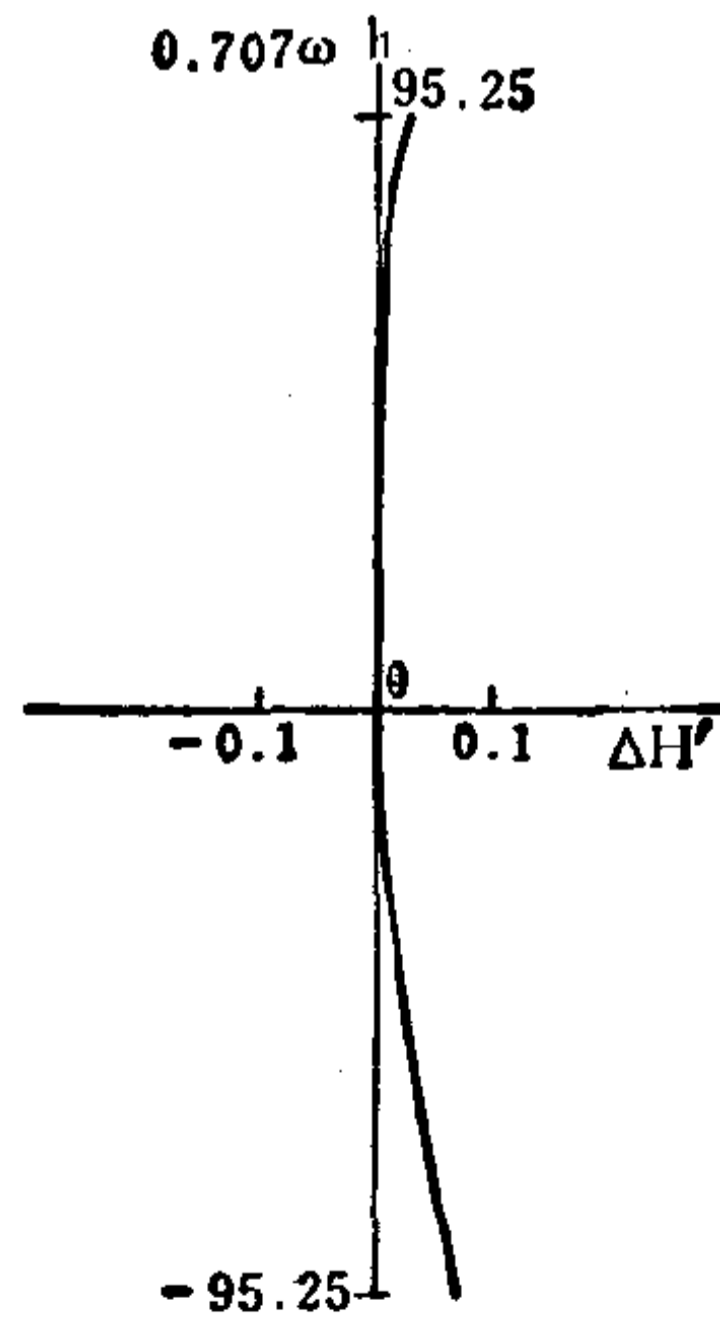
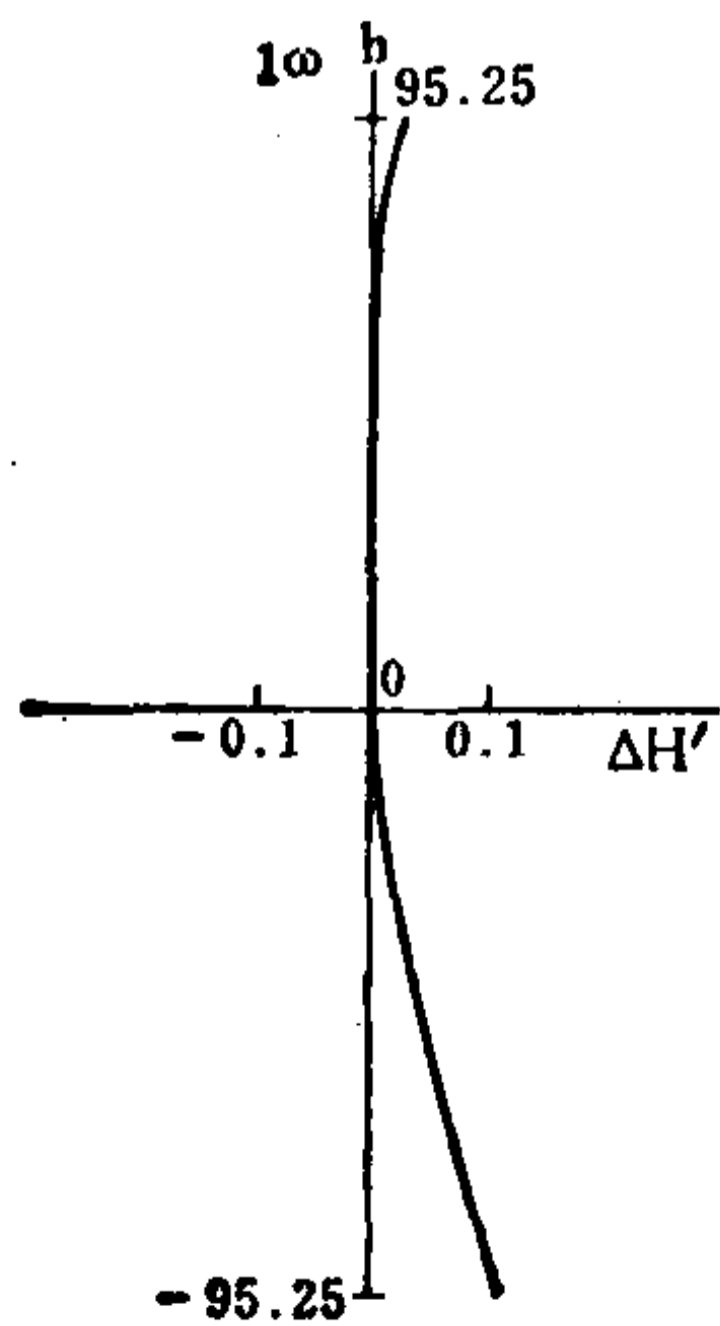
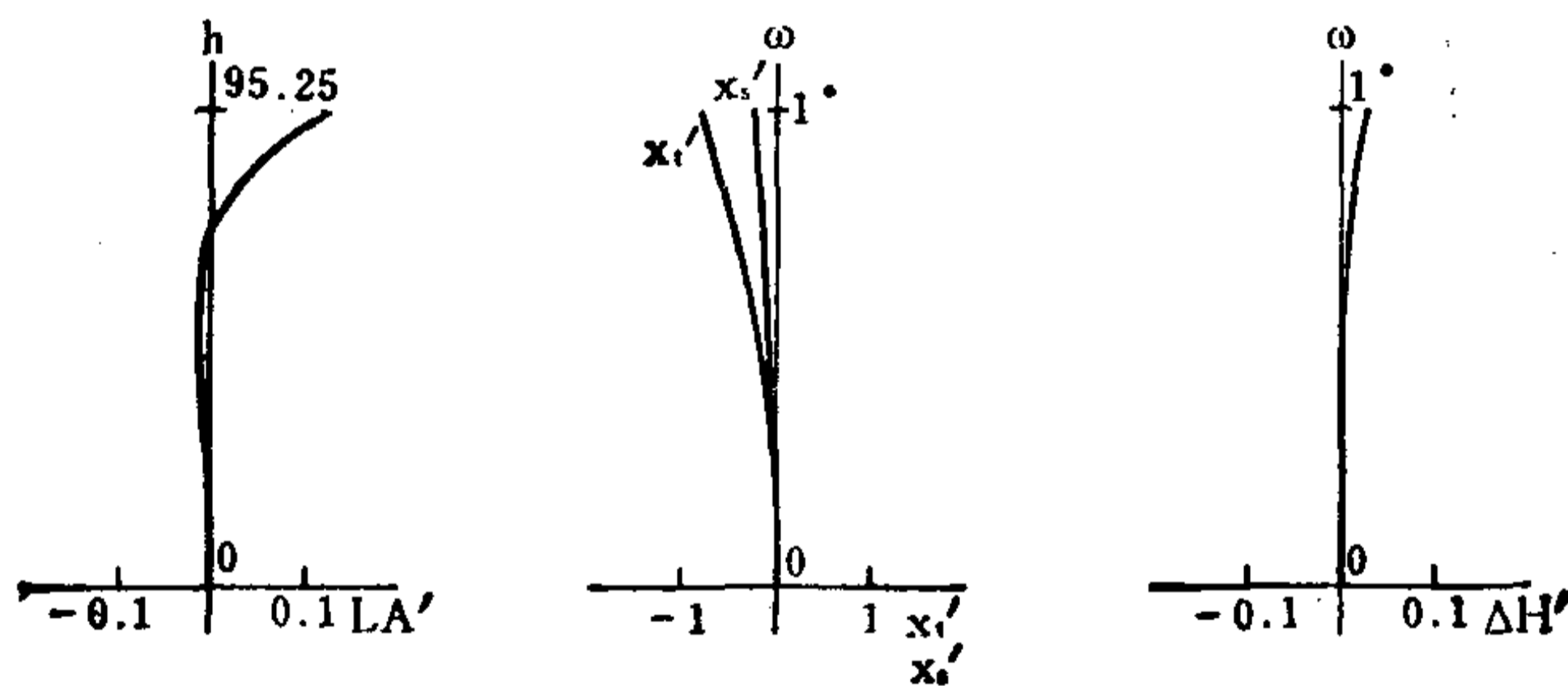

编号: 05-04-008

卡塞格伦型折反射透镜系统

E. F. L = 2095 B. F. L = 164.8 FNo. = 8.38 F. A. = ±1° $L'_p = -7.33$

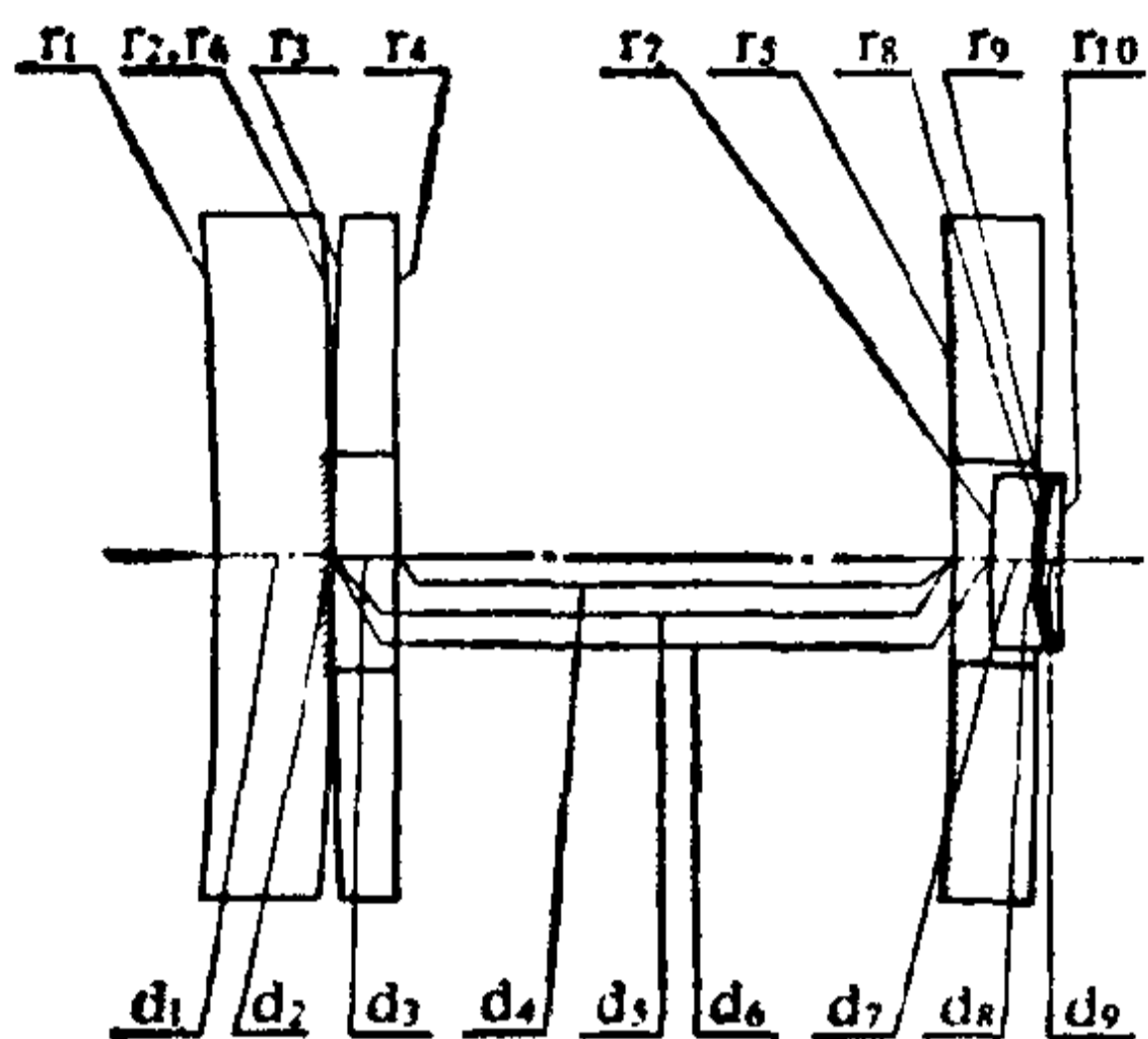

序号	r	d	n	v	序号	r	d	n	v
1	-1062.13	31.59	1.516864.2		6	-1550.06	616.34		
2	-1550.06	0			7	363.76	11.45	1.516864.2	
3	3507.61	16.02	1.516864.2		8	80.35	1.42		
4	∞	587.01			9	81.53	3.45	1.516864.2	
5	-1983.84	-603.04	-1.0000		10	288.52			

	ΣS_1	ΣS_2	ΣS_3	ΣS_4	ΣS_5	HI	QP (1 ω)
	-0.00099	-0.00027	-0.00103	0.00013	0.00669	36.56	0.16%
h 或 ω %	LA'	$\Delta H'$	x'_t	x'_s	$x'_t - x'_s$	K'_{T1}	$K'_{T0.7}$
100	-0.133	0.057	-0.283	-0.089	-0.194	-0.00202	-0.00063
70	-0.068	0.020	-0.171	-0.054	-0.117	-0.00377	-0.00161

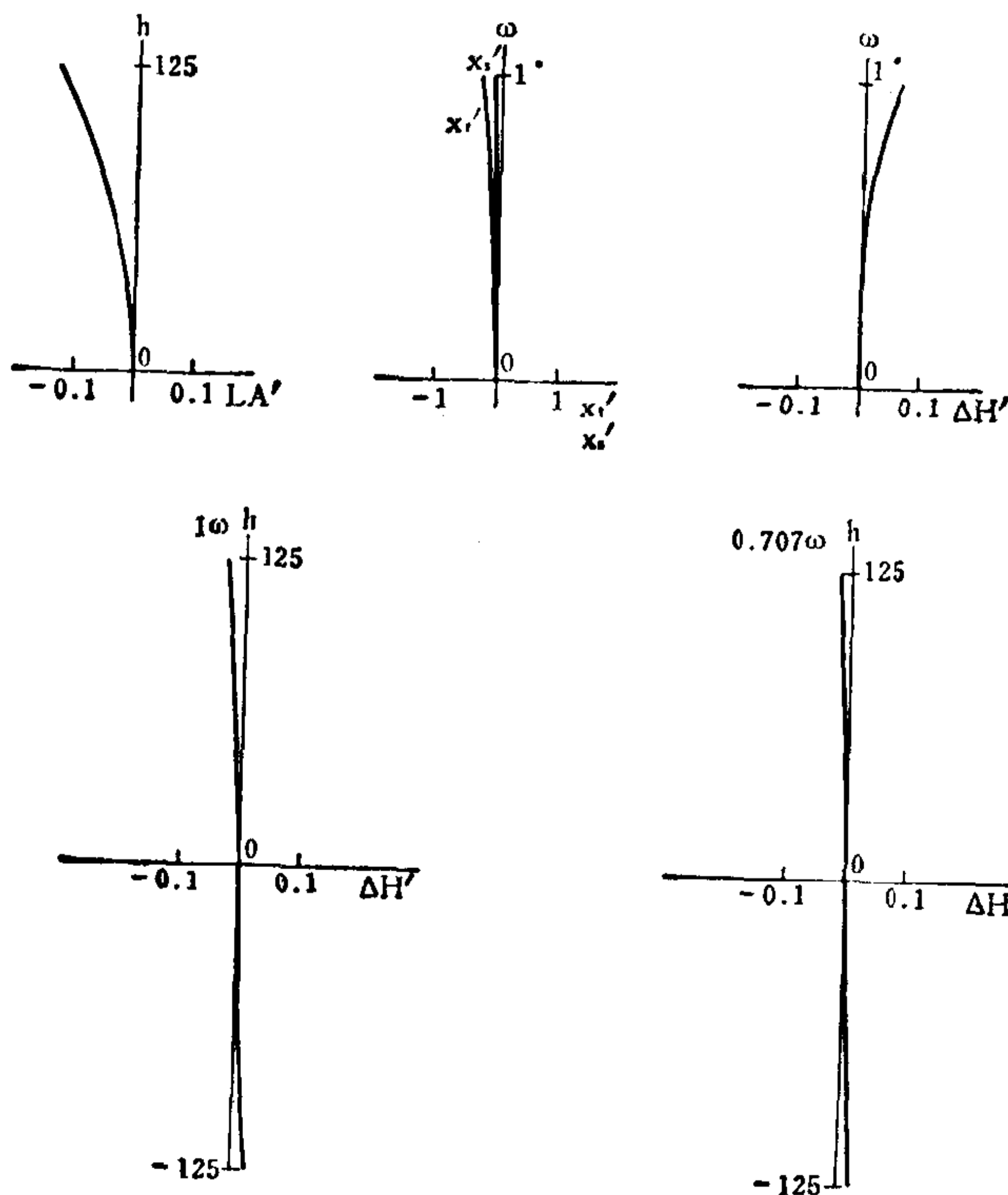

编号: 05-04-009

对称三组元照相复印装置透镜系统

E. F. L = 1.0

B. F. L = 0.825

FNo. = 5.6

F. A. = ± 20°

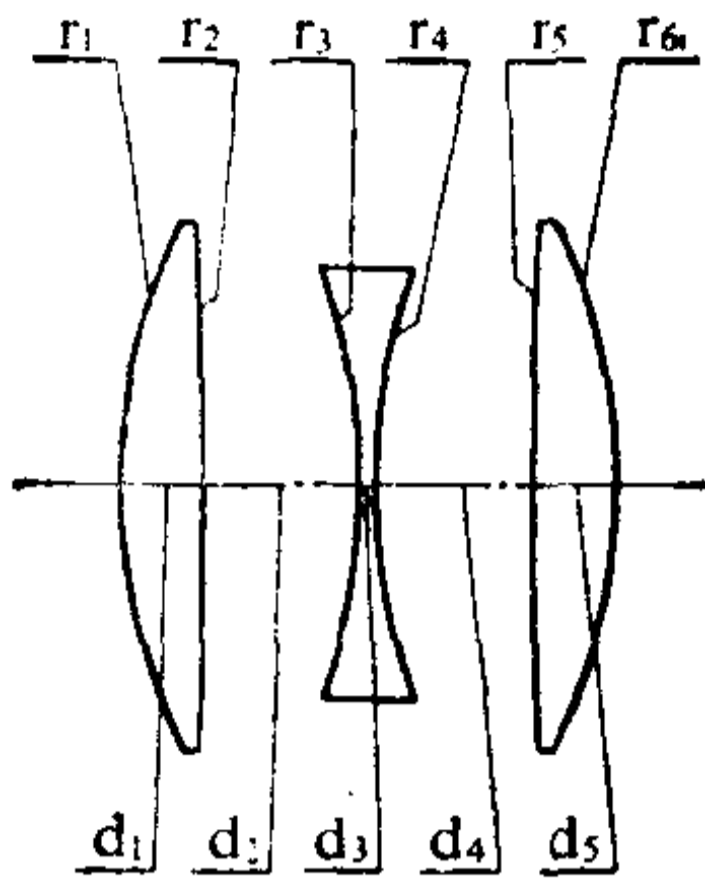

序号	r	d	n _D	v	序号	r	d	n _D	v
1	0.3907	0.0542	1.620	60.3	4	0.4153	0.0995		
2	-3.4709	0.0995*			5	3.4709	0.0542	1.620	60.3
3	-0.4153	0.0101	1.596	39.7	6	-0.3907			

0.0995* = 0.0500 + 0.0495

	ΣS ₁	ΣS ₂	ΣS ₃	ΣS ₄	ΣS ₅	HI	QP (1ω)
	0.000038	-0.000092	-0.000034	-0.000353	0.000473	0.365	1.05%
h 或 ω %	LA'	ΔH'	x _t	x' _s	x' _t -x' _s	K' _{T1}	K' _{T0.7}
100	0.0050	0.0038	-0.0339	-0.0186	-0.0153	0.000294	0.000092
70	0.0018	0.0011	-0.0156	-0.0113	-0.0043	-0.000633	-0.000331

注: 以上象差值是按 l = -∞ 计算的。

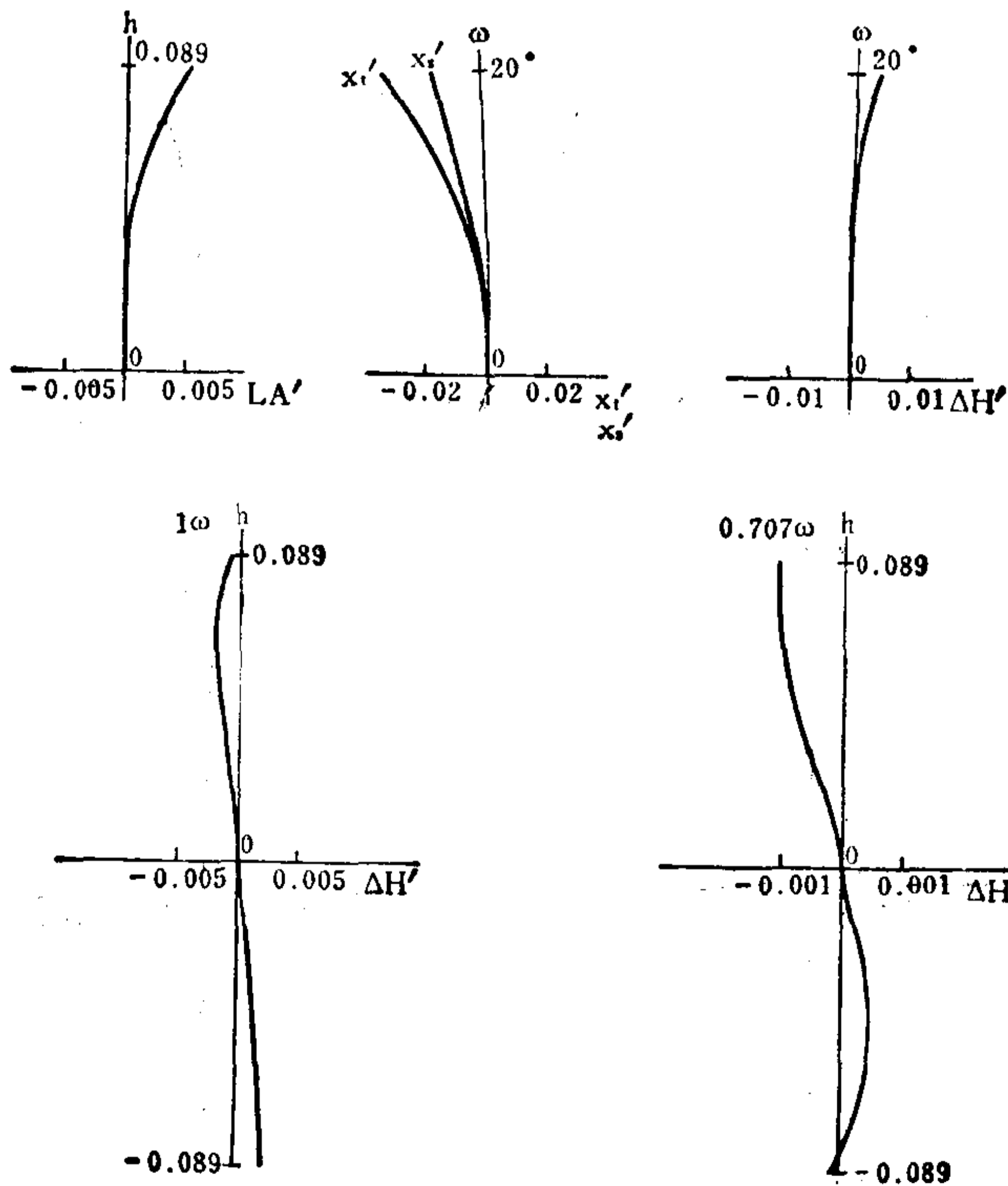

编号: 05-04-010

高斯型摄影物镜

E. F. L = 1.0

B. F. L = 0.68

FNo. = 2.8

F. A. = ± 18°

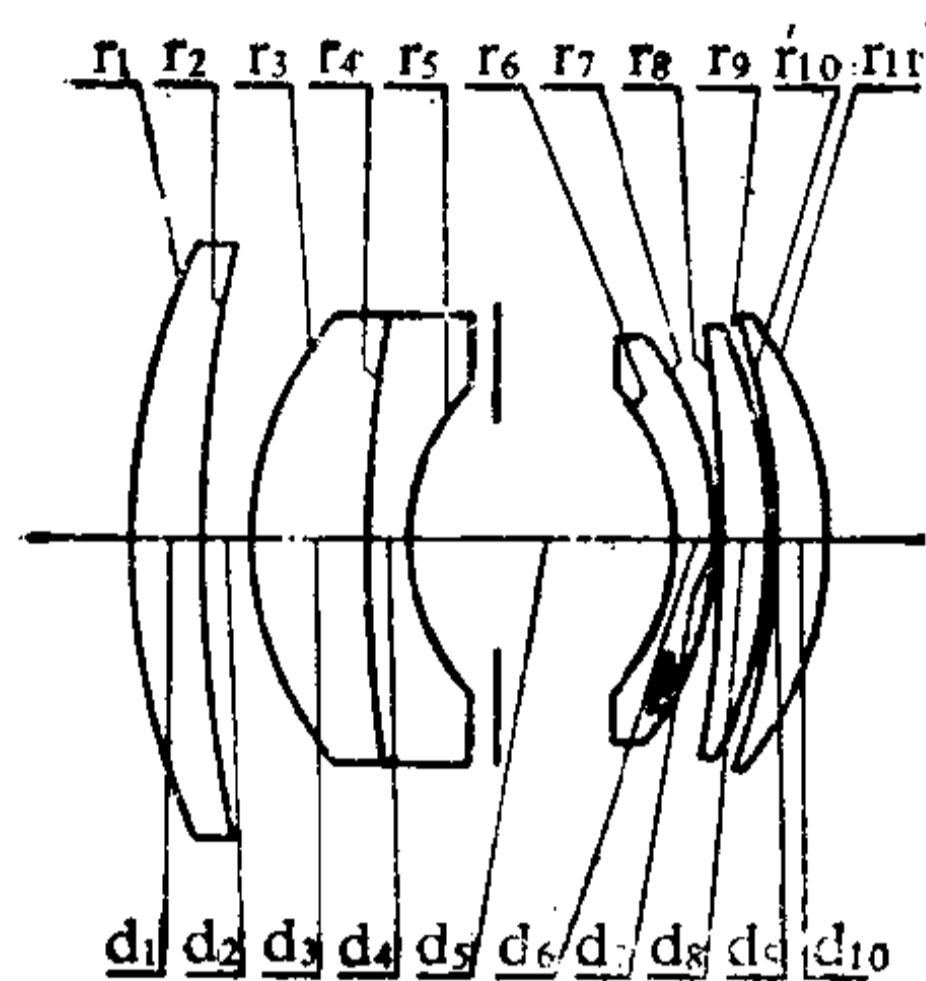

序号	r	d	n _e	v _e	序号	r	d	n _e	v _e
1	0.6373	0.0600	1.74795	44.5	7	-0.2853	0.0028		
2	1.2995	0.0390			8	-1.1428	0.0432	1.62287	60.1
3	0.2895	0.1029	1.69282	49.5	9	-0.4434	0.0028		
4	1.1521	0.0339	1.67764	32.0	10	-0.5971	0.0440	1.61521	58.4
5	0.1928	0.2234*			11	-0.3237			
6	-0.2020	0.0359	1.74070	26.2					

0.2234* = 0.0700 + 0.1534

	ΣS ₁	ΣS ₂	ΣS ₃	ΣS ₄	ΣS ₅	HI	QP (1ω)
	-0.000532	-0.000157	0.000063	-0.000331	-0.000137	0.324	-0.27%
h 或 ω %	LA'	ΔH'	x' _t	x' _s	x' _t - x' _s	K' _{T1}	K' _{T0.7}
100	-0.00088	-0.00086	-0.0027	-0.0022	-0.0005	0.00047	-0.00039
70	-0.00233	-0.00021	-0.0012	-0.0017	0.0005	-0.00049	-0.00036

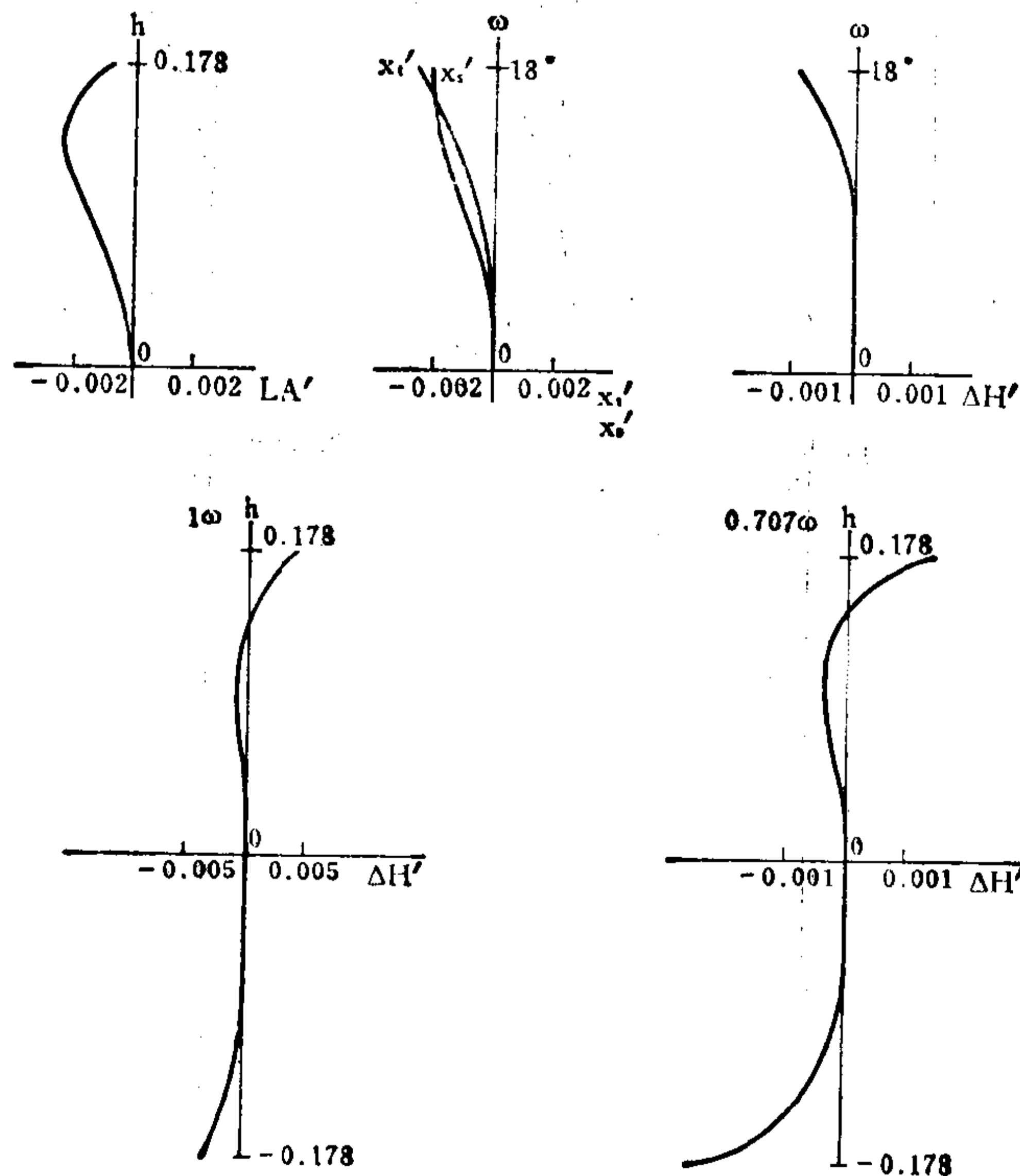

编号: 05-04-011

改进的物镜系统

E. F. L = 100.1

B. F. L = 78.81

FNo. = 10

F. A. = $\pm 15^\circ$ **

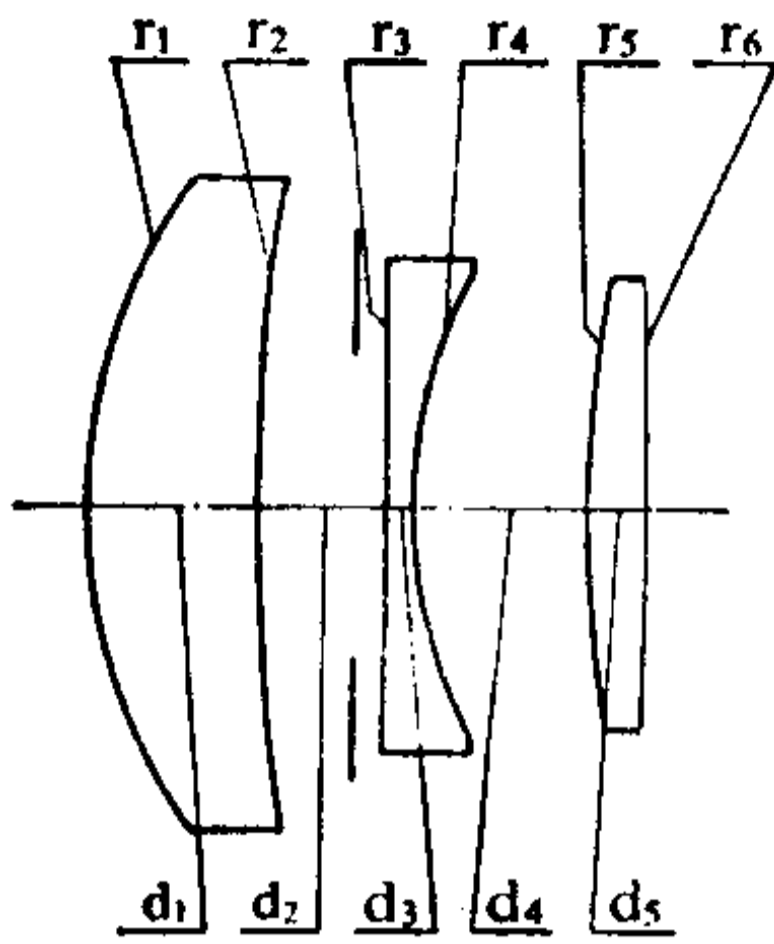

序号	r	d	n_D	v	序号	r	d	n_D	v
1	14.70	4.36	1.613	58.6	4	13.00	4.28		
2	60.11	3.30*			5	31.87	1.48	1.620	36.4
3	-2324.90	0.79	1.673	32.2	6	-293.57			

$3.30^* = 2.50 + 0.80$

	ΣS_1	ΣS_2	ΣS_3	ΣS_4	ΣS_5	HI	QP (1 ω)
	-0.00508	0.00226	0.00453	-0.00289	0.02578	26.85	0.94%
h 或 ω %	LA'	$\Delta H'$	x'_i	x'_s	$x'_i - x'_s$	K'_{T1}	$K_{T0.7}$
100	-1.077	0.253	2.069	0.654	1.415	0.1731	0.0834
70	-0.524	0.093	1.126	0.246	0.880	0.0806	0.0408

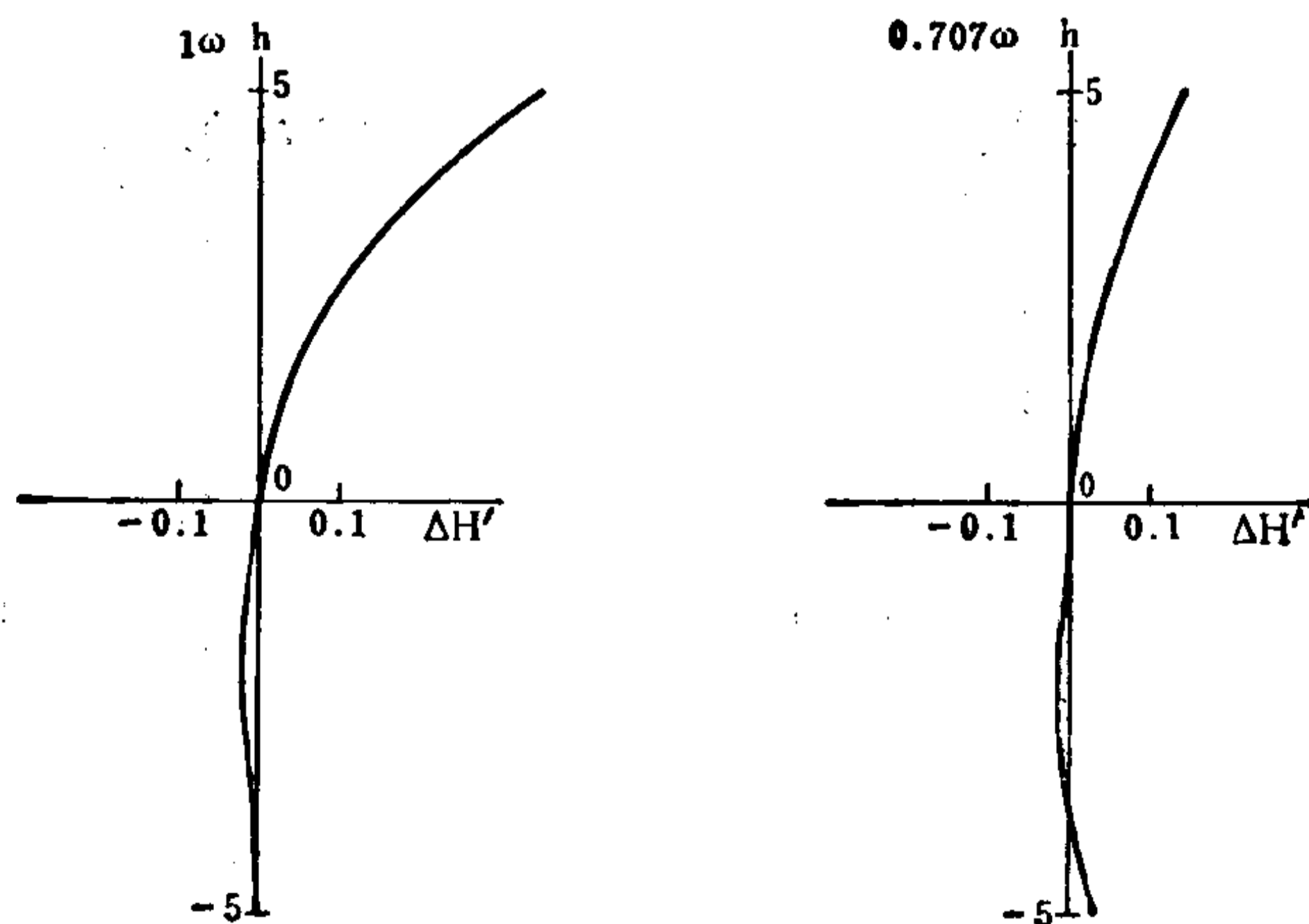
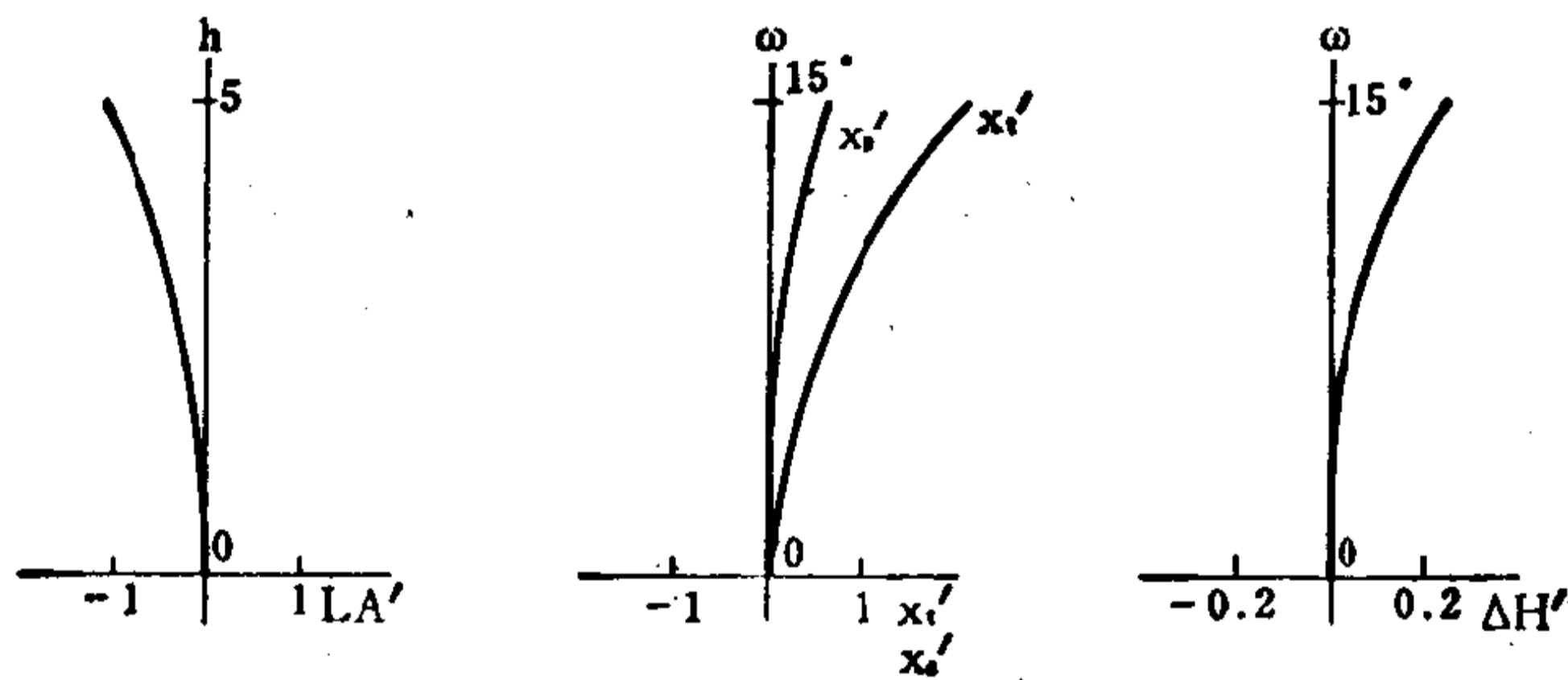

编号: 05-04-012

远 距 离 照 相 物 镜

E. F. L = 100

B. F. L = 42.618

FN₀ = 4.5

F. A. = ±12.1°

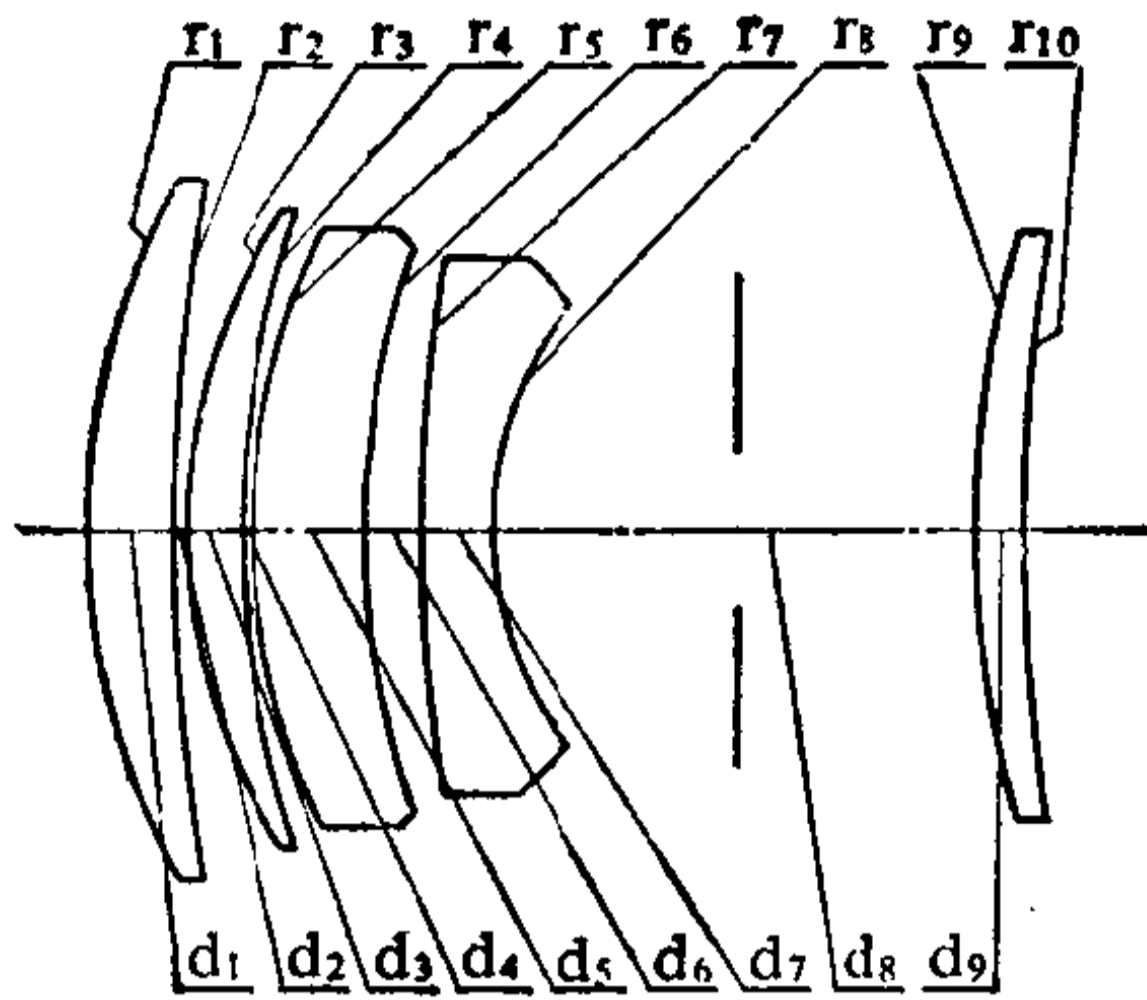

序号	r	d	n	v	序号	r	d	n	v
1	39.42	4.72	1.58913	61.1	6	45.79	2.61		
2	192.88	0.42			7	91.23	3.89	1.78470	26.2
3	31.58	3.36	1.56873	63.1	8	19.10	25.78*		
4	54.73	0.25			9	63.30	2.55	1.78470	26.2
5	36.24	6.39	1.70154	41.1	10	174.15			

25.78* = 13.00 + 12.78

	ΣS_1	ΣS_2	ΣS_3	ΣS_4	ΣS_5	HI	QP (1 ω)
	-0.00182	-0.00057	0.00095	-0.00505	0.06888	21.42	1.08%
h 或 ω %	LA'	$\Delta H'$	x_t	x_n	$x_t' - x_n'$	KT ₁	KT _{0.7}
100	-0.0235	0.2307	-0.0433	-0.0384	-0.0049	0.00327	0.00322
70	-0.0248	0.0984	-0.0193	-0.0544	0.0351	-0.00778	-0.00243

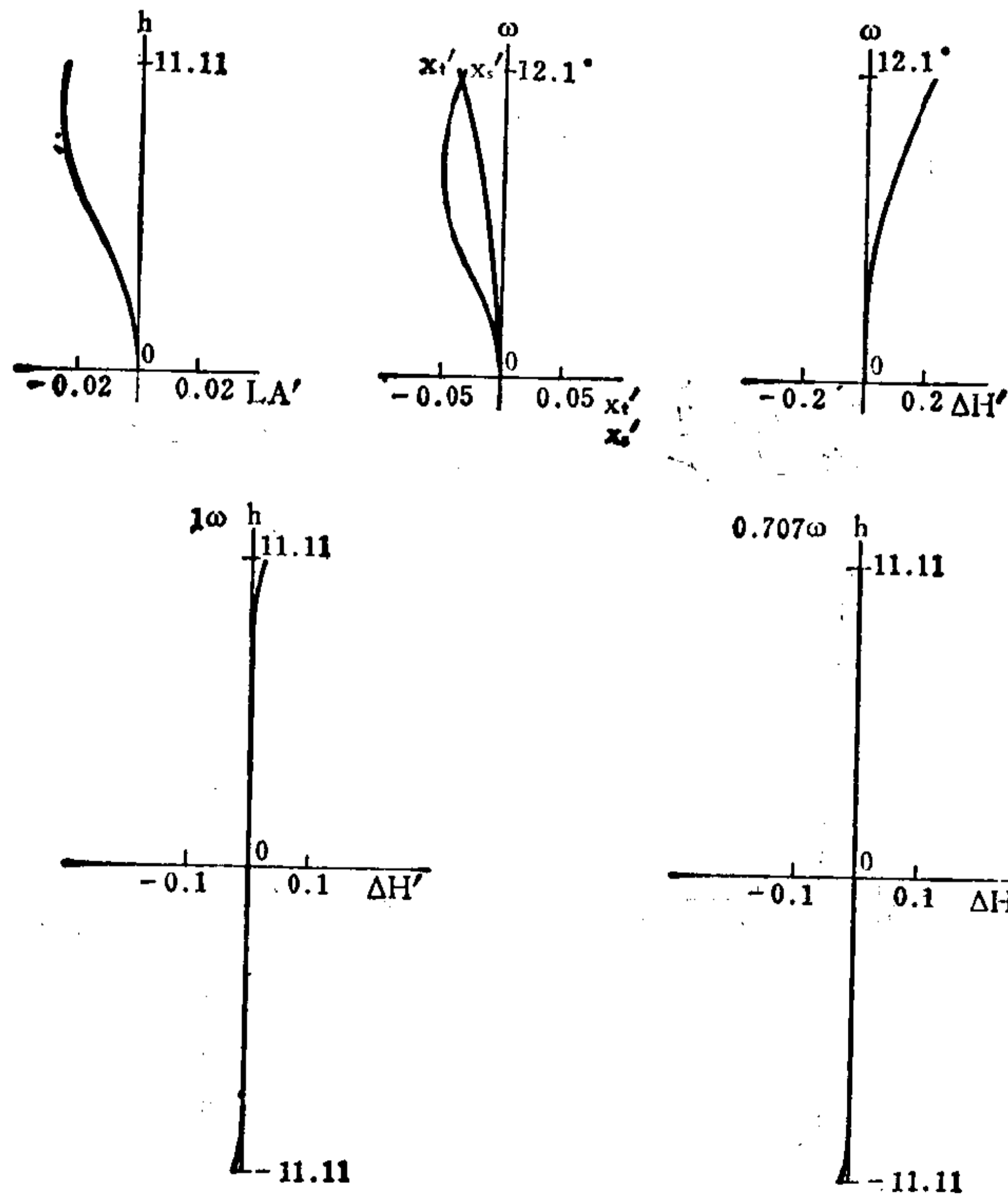

编号: 05-04-013

显微照相物镜

E. F. L = 65

B. F. L = 34.2

FNo. = 6

F. A. = $\pm 30^{\circ}$ **

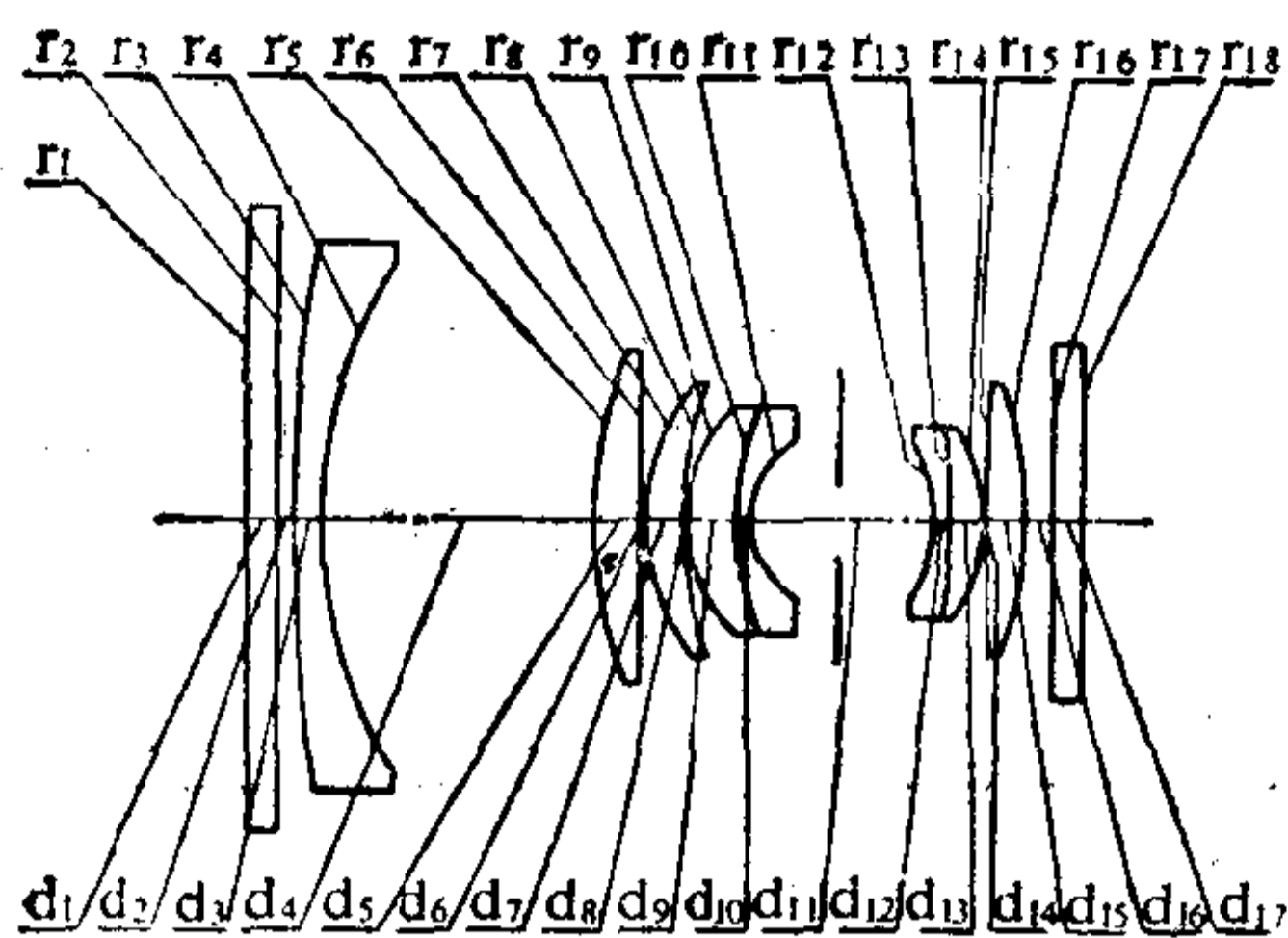

序号	r	d	n _D	v	序号	r	d	n _D	v
1	∞	4.000	1.5169	64.20	10	40.25	2.000	1.6722	32.20
2	∞	2.000			11	13.79	23.658*		
3	238.00	4.000	1.5891	61.24	12	-19.76	2.100	1.6476	33.90
4	65.61	36.000			13	-95.00	4.395	1.6591	50.88
5	58.00	6.500	1.5891	61.24	14	-23.20	0.200		
6	∞	0.200			15	731.00	5.200	1.5891	61.24
7	29.60	5.000	1.5169	64.20	16	-52.50	3.775		
8	49.65	0.200			17	∞	3.810	1.5224	59.48
9	21.20	7.094	1.6591	50.88	18	∞			

$23.658^* = 10.000 + 13.658$

	ΣS_1	ΣS_2	ΣS_3	ΣS_4	ΣS_5	HI	QP (1 ω)
	-0.000805	-0.000651	0.001775	-0.010330	0.012281	37.41	0.35%
h 或 ω %	LA'	$\Delta H'$	x'_t	x'_s	$x'_t - x'_s$	K'_{T1}	$K'_{T0.7}$
100	-0.0282	0.1297	-0.6715	0.2610	-0.9325	-0.0044	-0.0034
70	-0.0217	0.0334	-0.2078	-0.1365	-0.0713	-0.0035	-0.0030

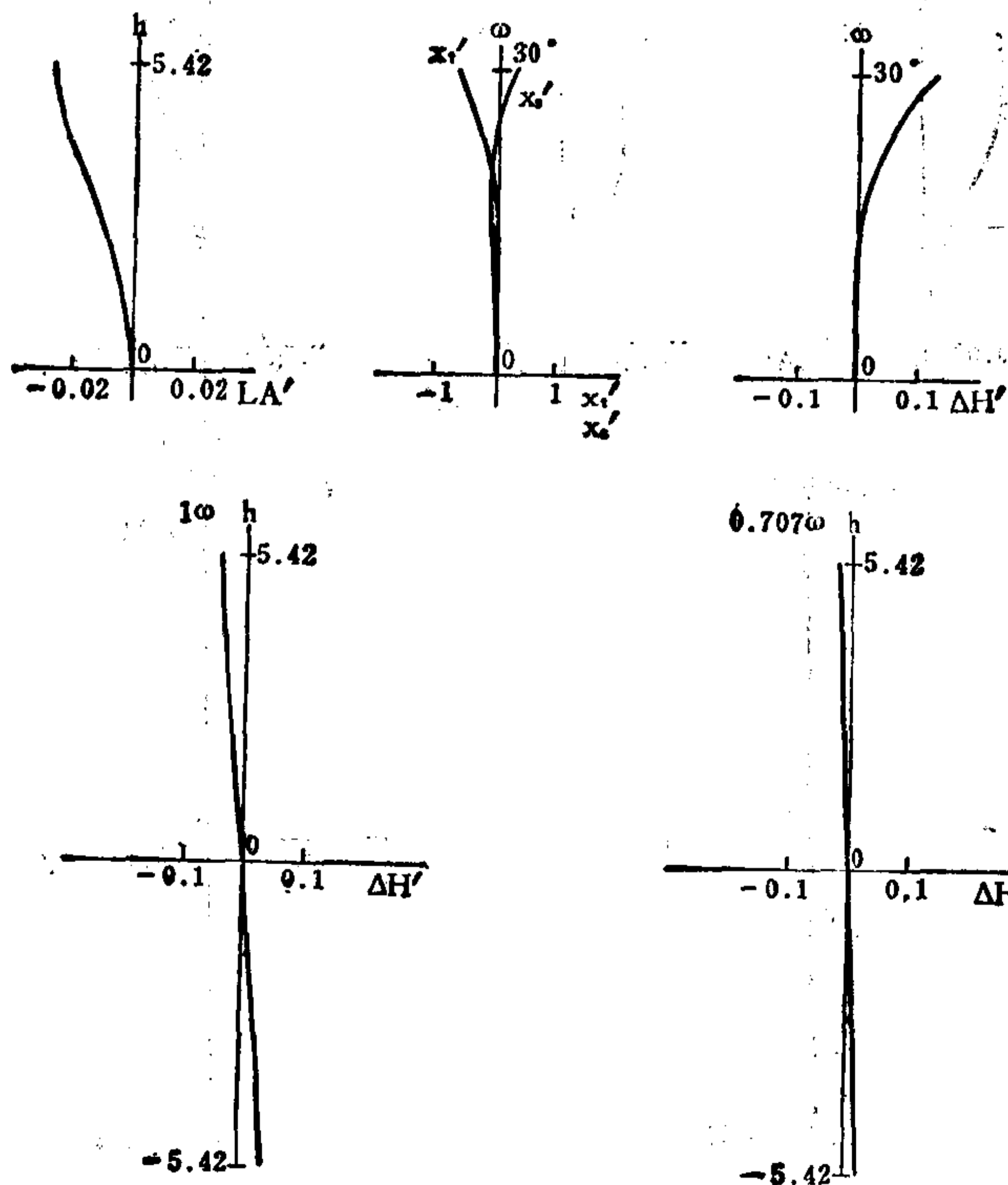

编号: 05-04-014



四片型摄影物镜

E.F.L=1.0

B.F.L=0.5105

FNo. =6.3

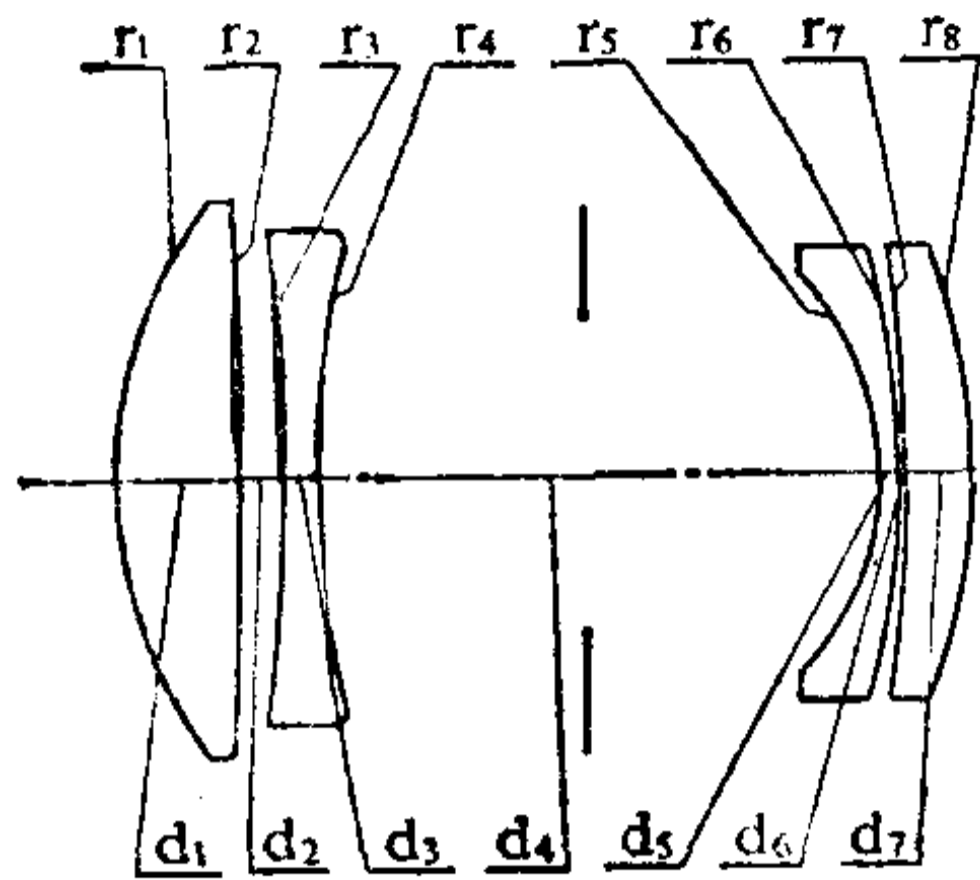

序号	r	d	n _e	v _e	序号	r	d	n _e	v _e
1	0.20485	0.05013	1.62286	60.06	5	-0.12450	0.01003	1.51872	63.96
2	-2.27185	0.02005			6	-0.37166	0.00060		
3	-0.95746	0.01404	1.67764	31.97	7	-1.92084	0.03008	1.64647	47.66
4	0.40183	0.24062*			8	-0.26705			

0.24062* = 0.10000 + 0.14062

	ΣS_1	ΣS_2	ΣS_3	ΣS_4	ΣS_5	HI	QP (1 ω)
	-0.000053	0.000037	-0.000017	-0.000024	0.000349	0.267	0.62%
h 或 ω %	LA'	$\Delta H'$	x'_t	x'_s	$x'_t - x'_s$	K'_{T1}	$K'_{T0.7}$
100	0.00123	0.00165	-0.00012	-0.00080	0.00068	-0.00106	-0.00032
70	-0.00092	0.00069	-0.00104	-0.00098	-0.00006	-0.00069	-0.00011

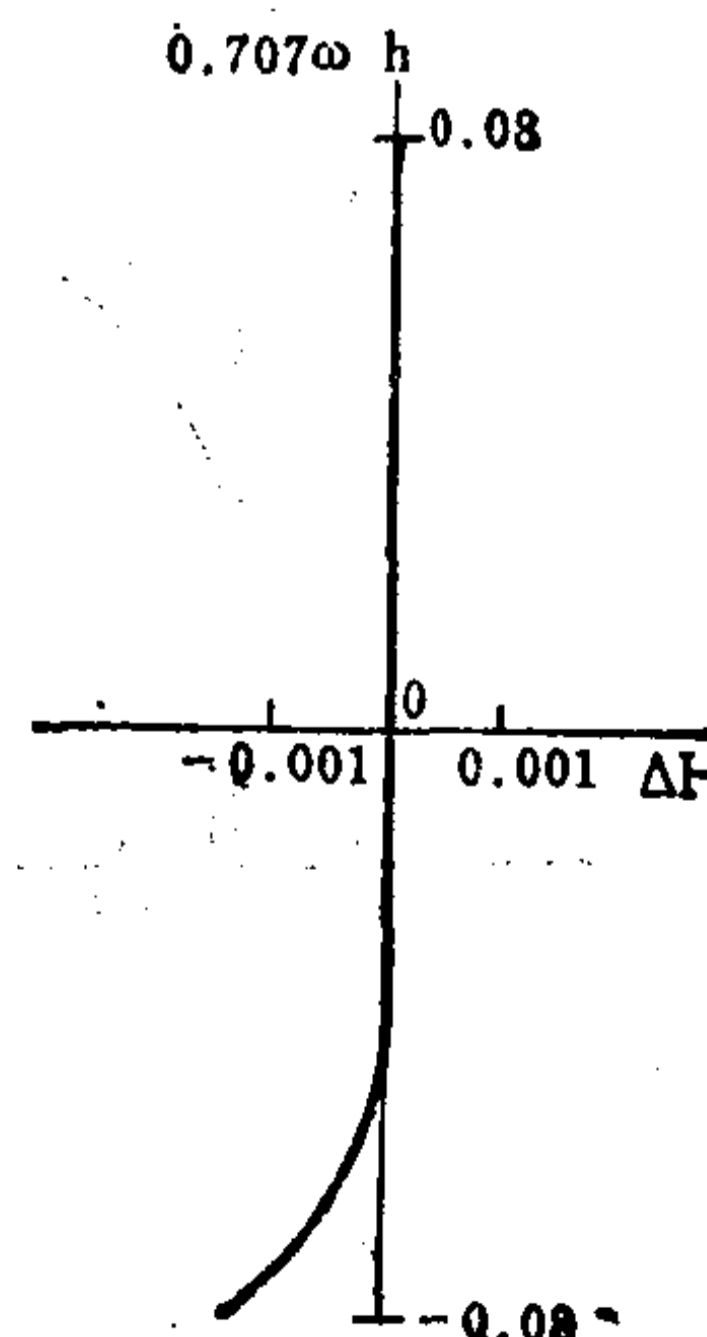
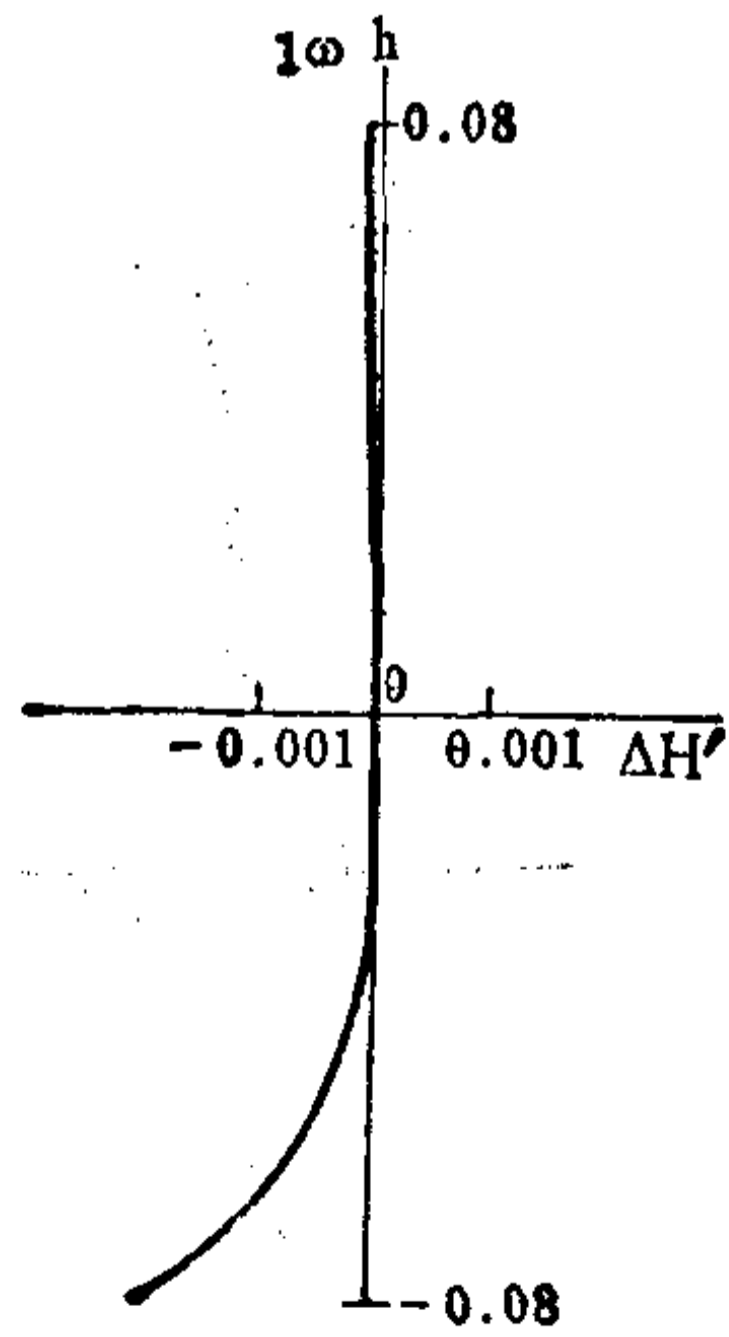
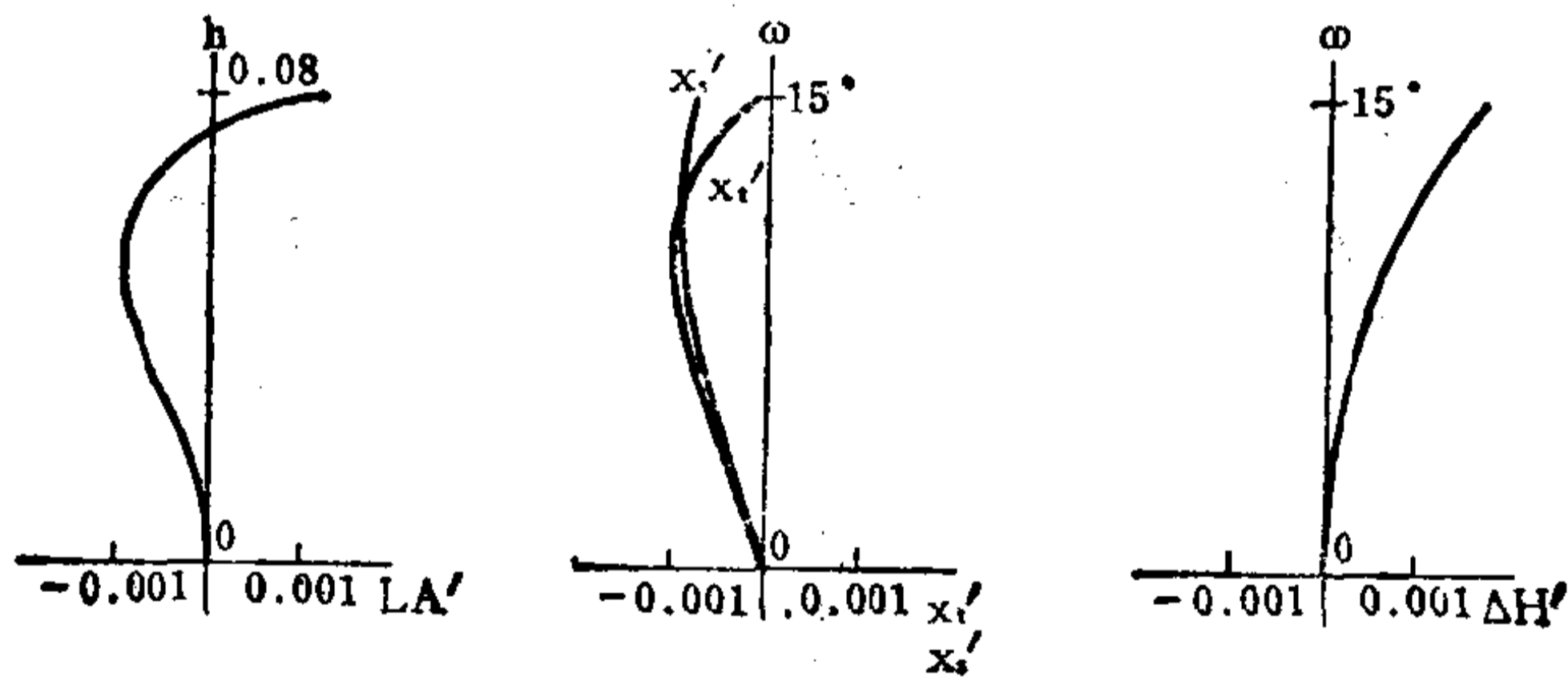

编号: 05-04-015

校正了球差、象散、色差的对称型摄影及重显透镜系统

E. F. L = 100

B. F. L = 92.87

FNo. = 9

F. A. = ± 20° **

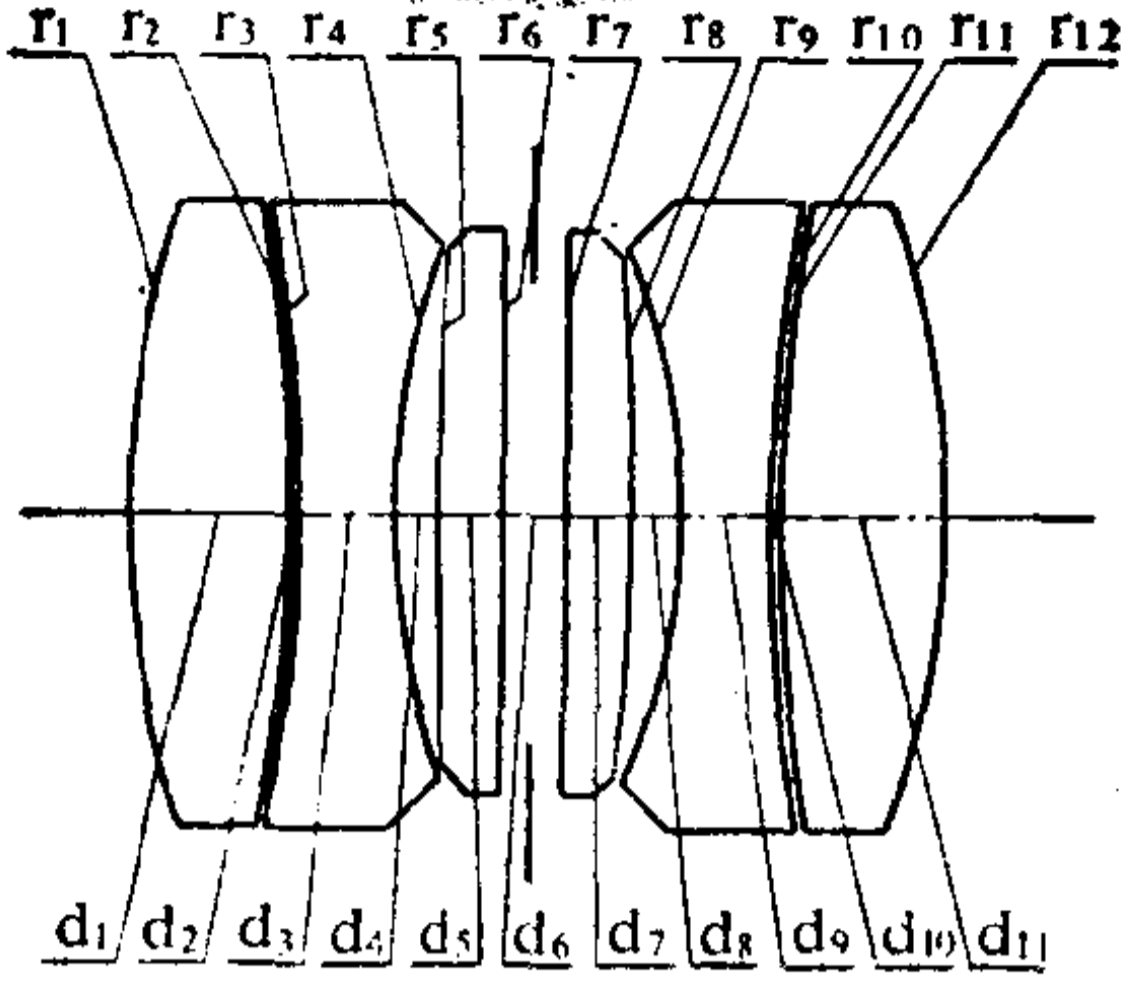

序号	r	d	n_d	v	序号	r	d	n_d	v
1	20.52	3.450	1.62146	57.4	7	∞	1.420	1.49715	66.9
2	-41.17	0.093			8	-128.26	0.800		
3	-38.34	2.170	1.54960	50.0	9	-16.95	2.170	1.54960	50.0
4	16.95	0.800			10	38.34	0.093		
5	128.26	1.420	1.49715	66.9	11	41.17	3.450	1.62146	57.4
6	∞	1.330*			12	-20.52			

1.330* = 0.665 + 0.665

	ΣS_1	ΣS_2	ΣS_3	ΣS_4	ΣS_5	HI	QP (1 ω)
	-0.00017	-0.00251	-0.00070	-0.00290	-0.00064	36.52	-0.01%
h 或 ω %	LA'	$\Delta H'$	x'_i	x'_s	$x'_i - x'_s$	K'_{T1}	$K'_{T0.7}$
100	0.0608	-0.0039	-0.4506	-0.0909	-0.3597	-0.1557	-0.0544
70	0.0049	-0.0018	-0.3113	-0.1821	-0.1292	-0.0969	-0.0358

注: 以上象差值是按 $l = -\infty$ 计算的。

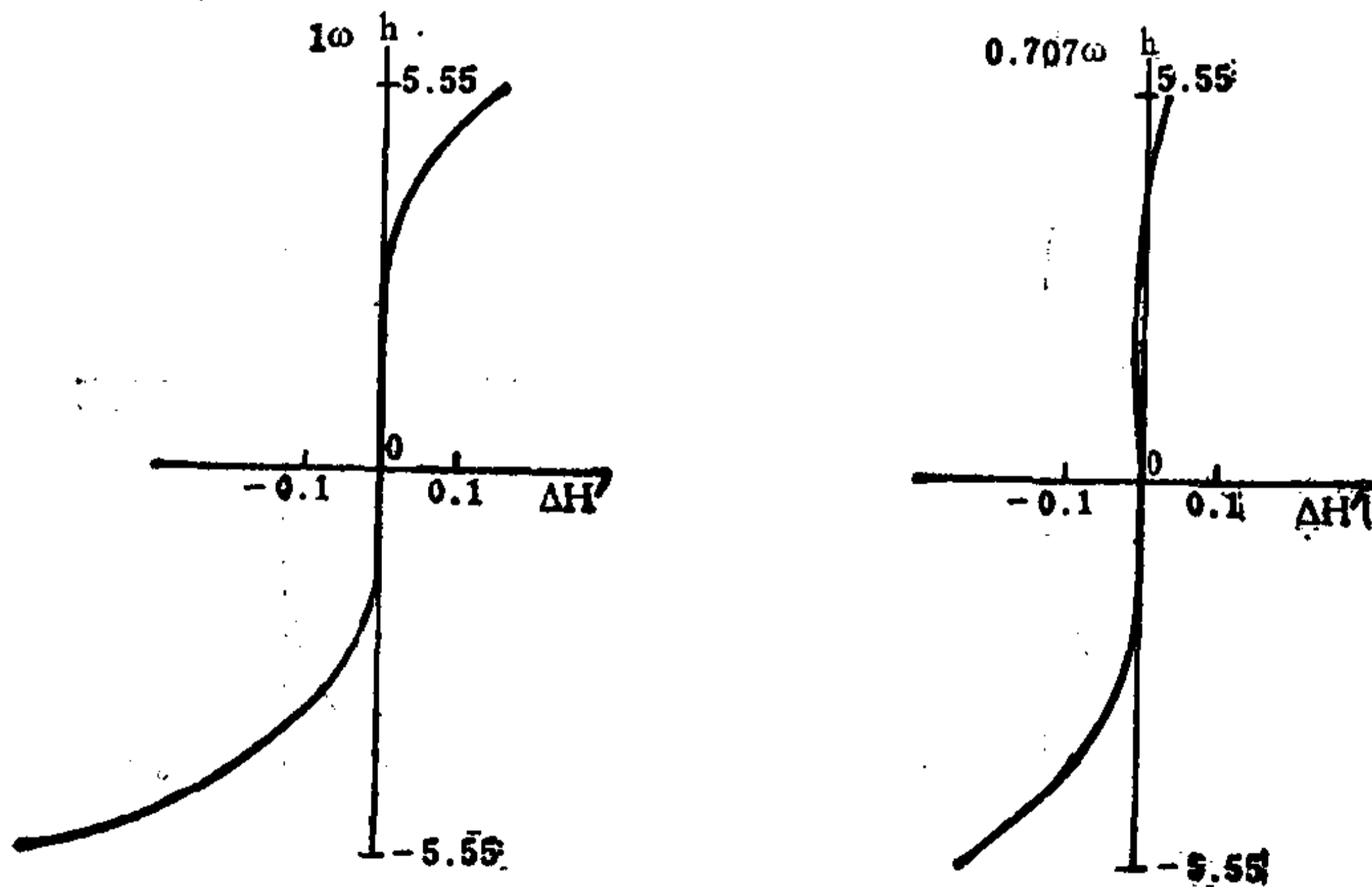
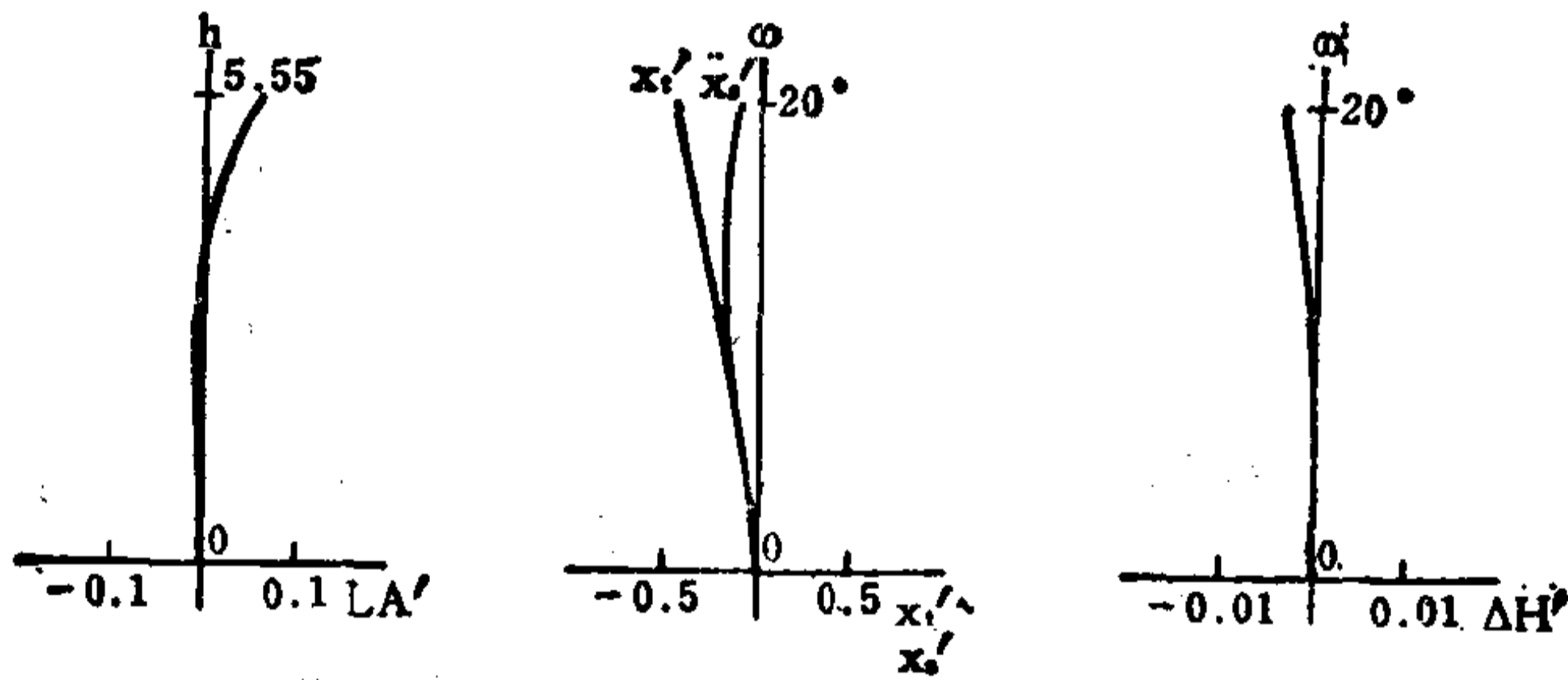

编号: 05-04-016

三片型投影透镜系统

E. F. L = 99.91

B. F. L = 65.65

FNo. = 2.5

F. A. = $\pm 20.05^\circ$

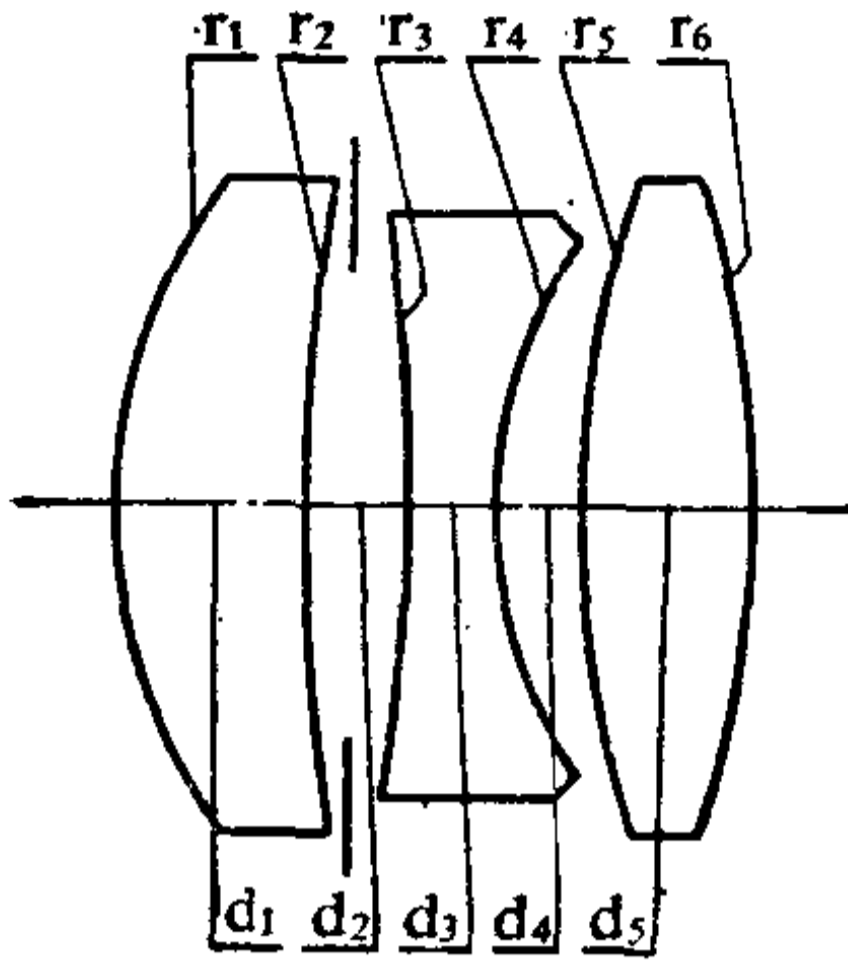

序号	r	d	n	v	序号	r	d	n	v
1	49.530	16.97	1.94283	36.1	4	42.293	7.93		
2	195.690	8.59*			5	95.029	14.87	1.94283	36.1
3	-188.130	8.00	1.94910	20.4	6	-95.029			

$8.59^* = 4.00 + 4.59$

	ΣS_1	ΣS_2	ΣS_3	ΣS_4	ΣS_5	HI	QP (ω)
	-0.09485	-0.00051	-0.00322	-0.16129	0.02855	36.47	-0.82%
h 或 $\omega\%$	LA'	$\Delta H'$	x'_t	x'_s	$x'_t - x'_s$	K'_{F1}	$K'_{F0.7}$
100	-0.553	-0.299	-2.974	-1.064	-1.910	0.1964	0.1115
70	-0.461	-0.015	-1.028	-0.838	-0.190	0.2051	0.0756

注: 1. $M = 37.894^*$;

2. 以上象差值是按 $l = -\infty$ 计算的。

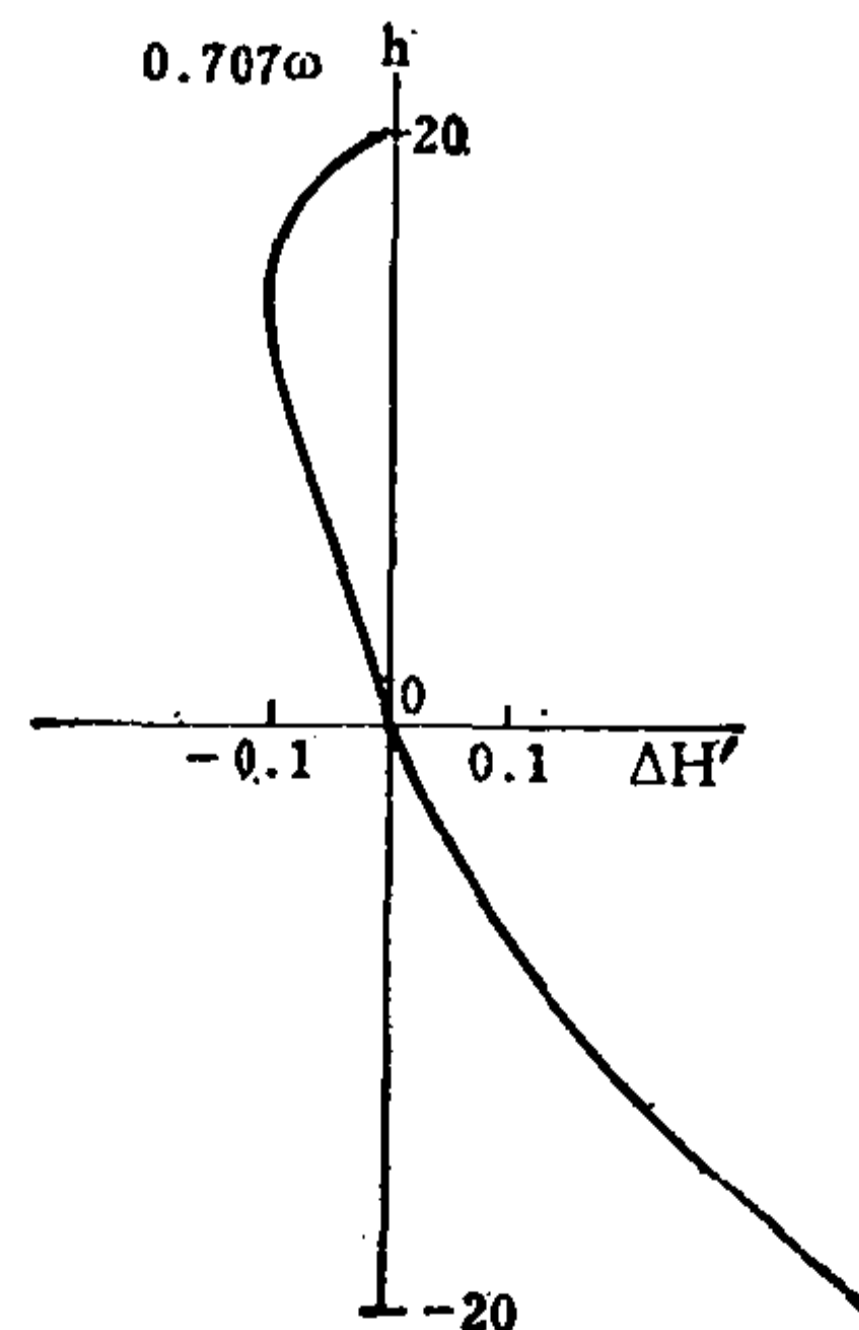
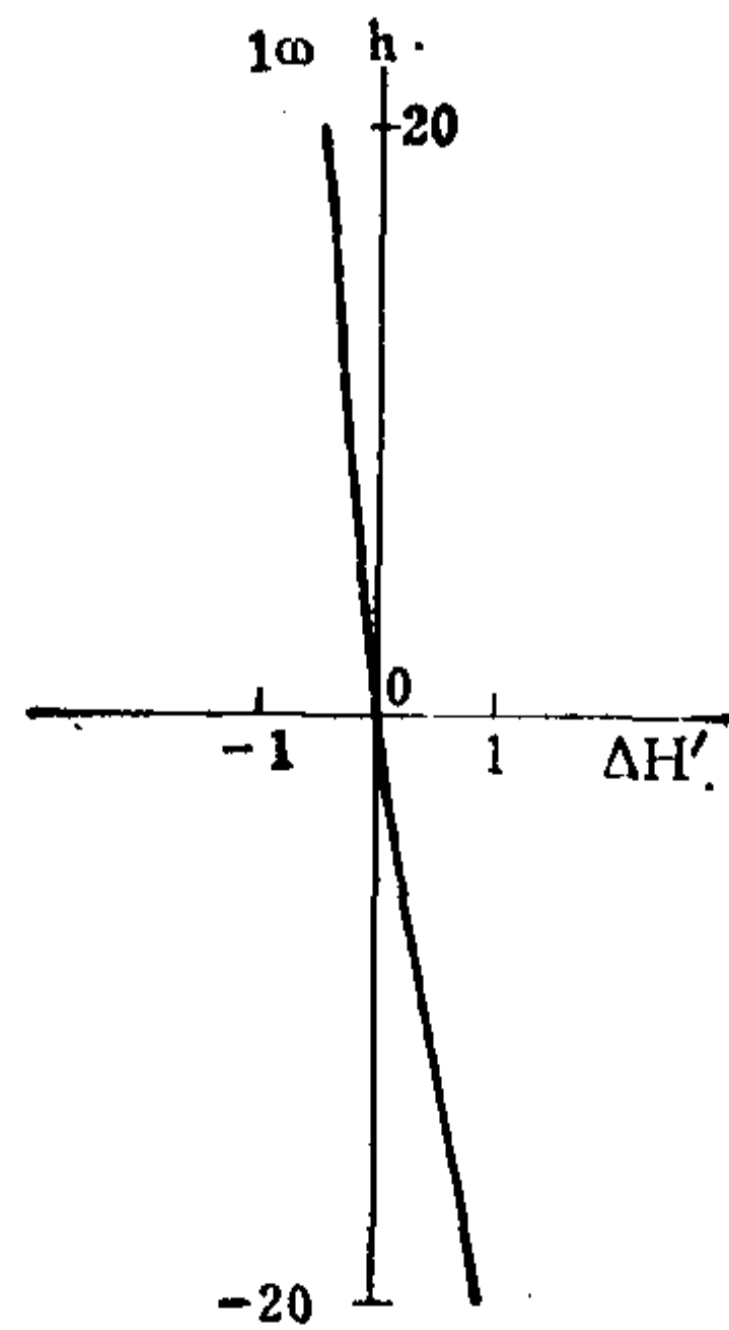
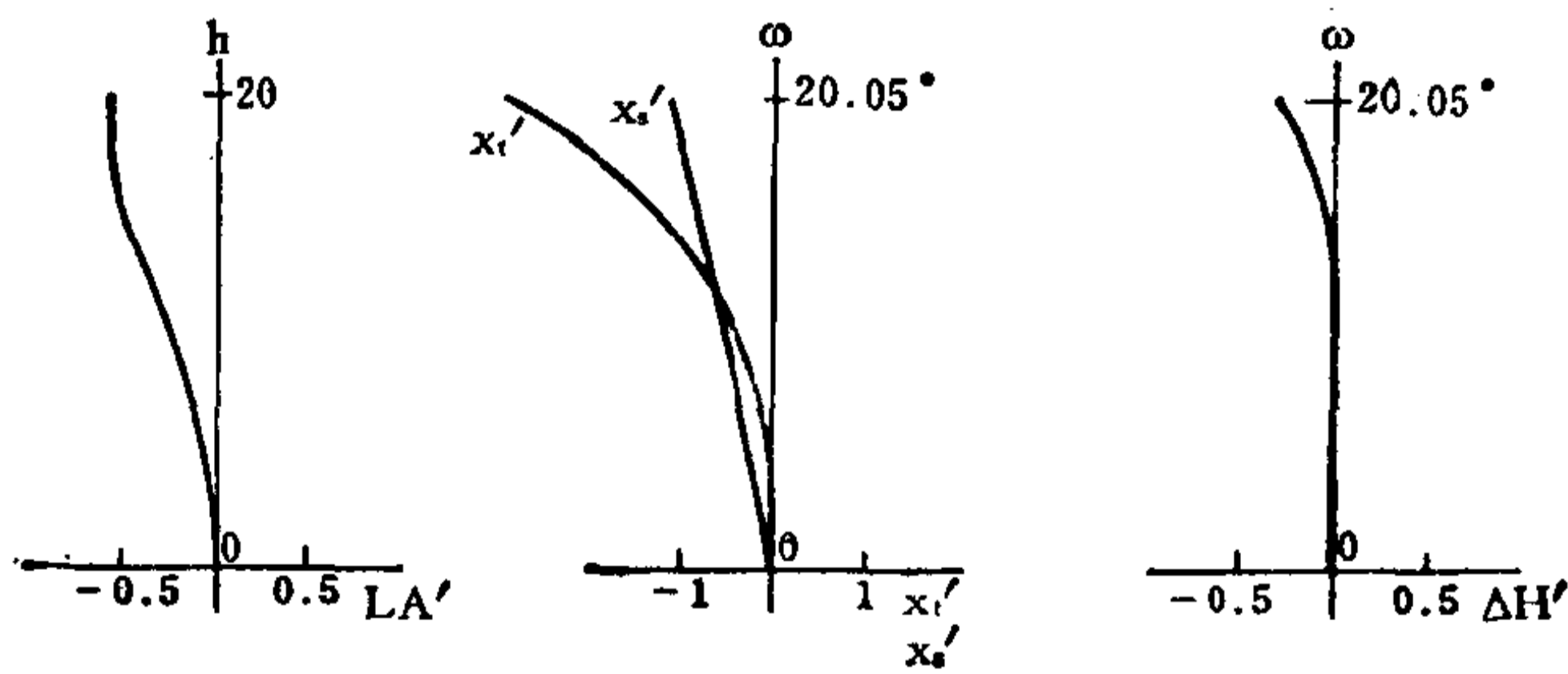

编号: 05-04-017

三片型投影透镜系统

E. F. L = 100

B. F. L = 68.39

FNo. = 2.8

F. A. = $\pm 20.5^\circ$

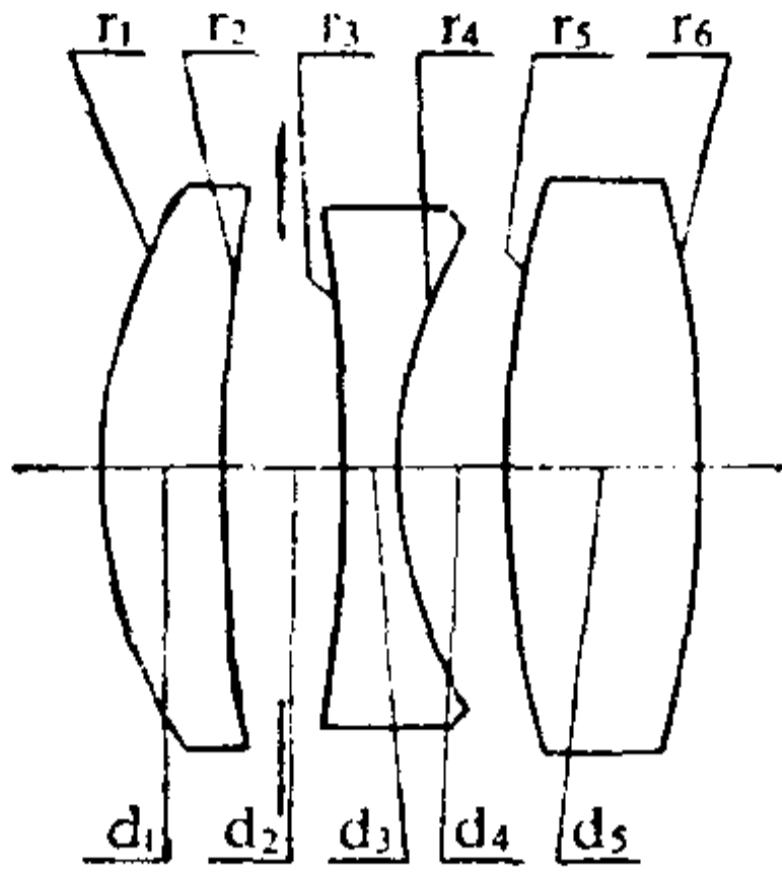

序号	r	d	n	v	序号	r	d	n	v
1	43.418	10.597	1.94283	36.1	4	38.567	8.982		
2	152.150	10.120*			5	97.978	16.710	1.94283	36.1
3	-234.000	5.089	1.94910	20.4	6	-97.978			

$10.120^* = 5.000 + 5.120$

	ΣS_1	ΣS_2	ΣS_3	ΣS_4	ΣS_5	HI	QP (1 ω)
	-0.0695	-0.0147	0.0138	-0.1248	-0.0272	37.42	-1.26%
h 或 ω %	LA'	$\Delta H'$	x_t	x'_s	$x_t - x_s$	K'_{T1}	$K'_{T0.7}$
100	-0.505	-0.471	-2.133	-0.538	-1.595	0.1507	0.0603
70	-0.422	-0.074	-0.581	-0.633	0.052	0.0733	0.0213

注: 1. $M = 29.031^*$,

2. 以上象差值是按 $l = -\infty$ 计算的。

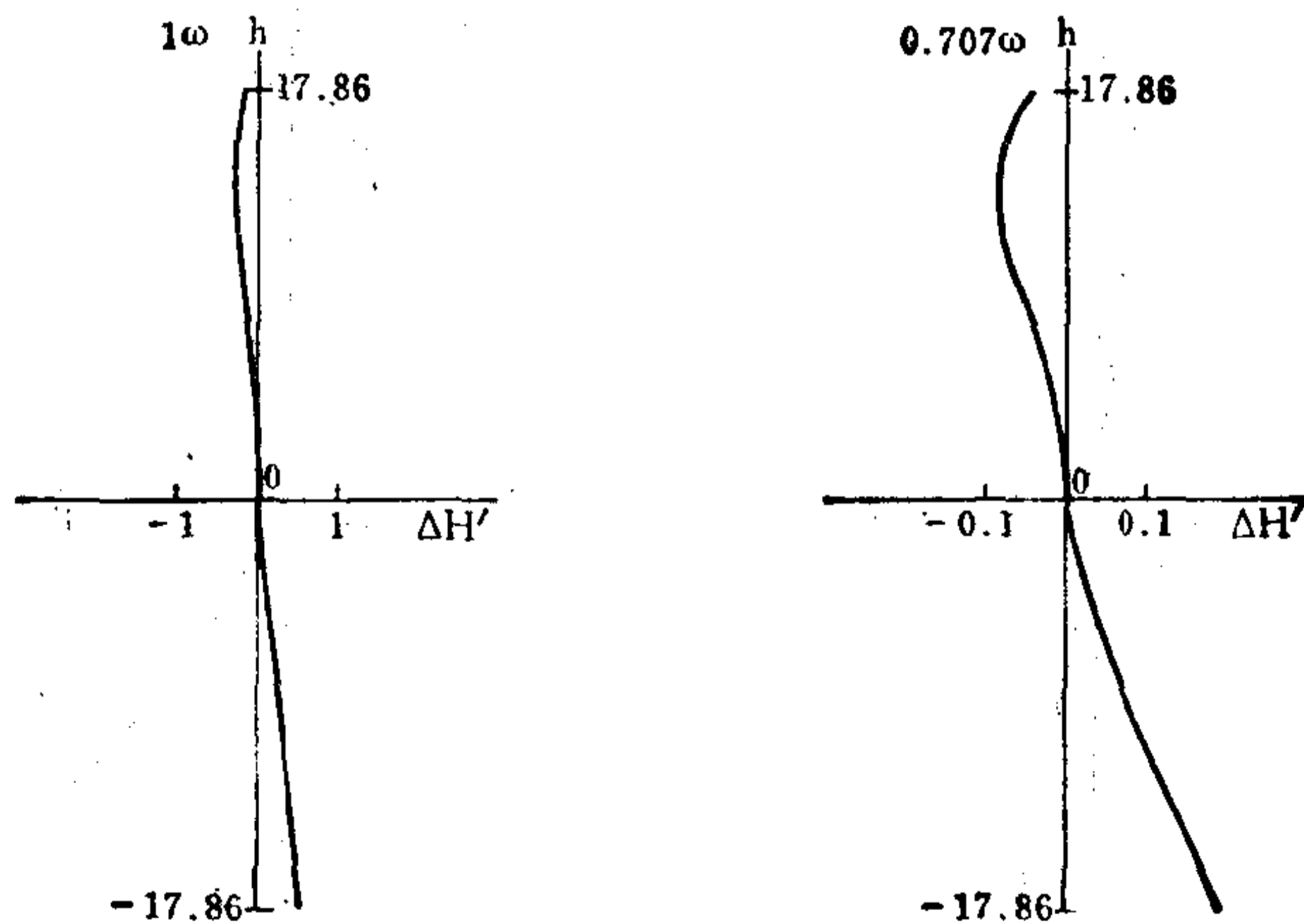
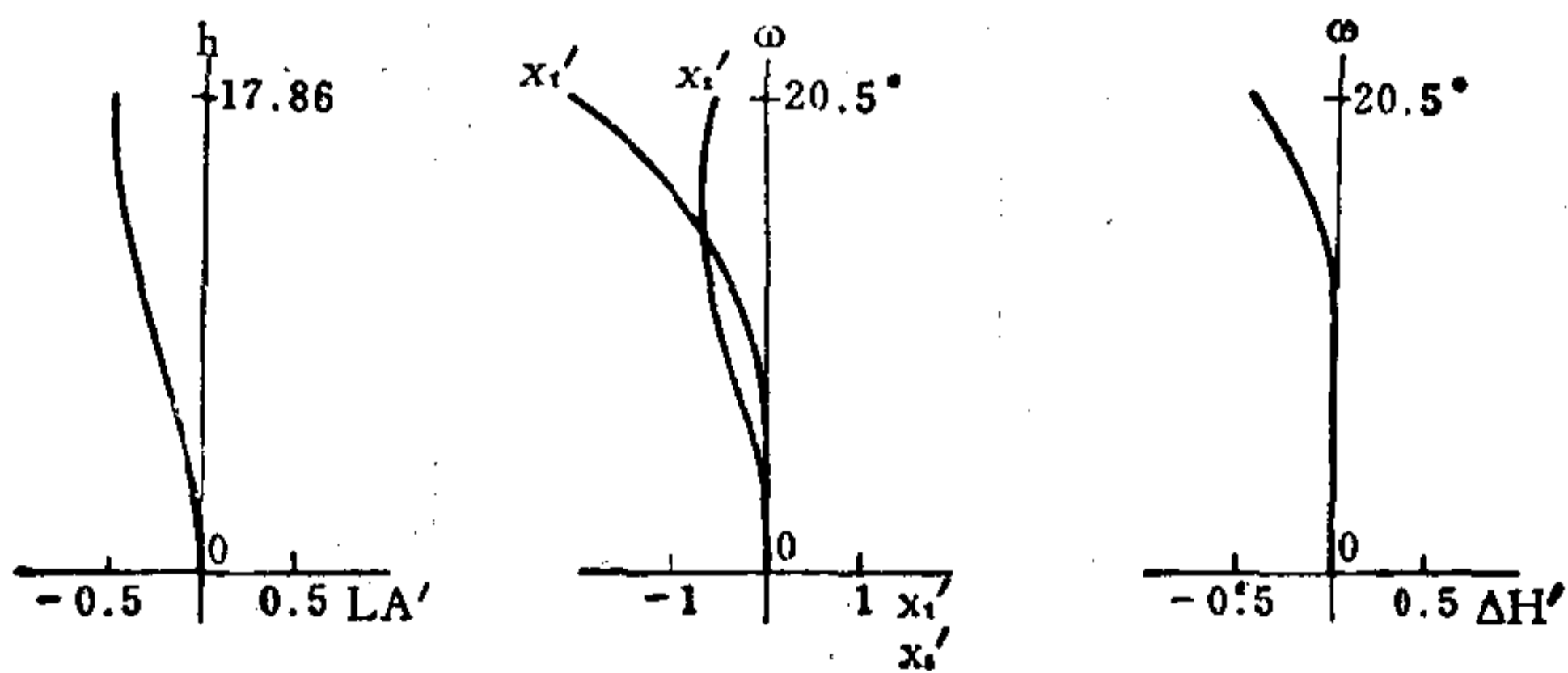

编号: 05-04-018

物 镜

E. F. L = 80.8

B. F. L = 33.1

FNo. = 6

F. A. = $\pm 25^{\circ}$ **

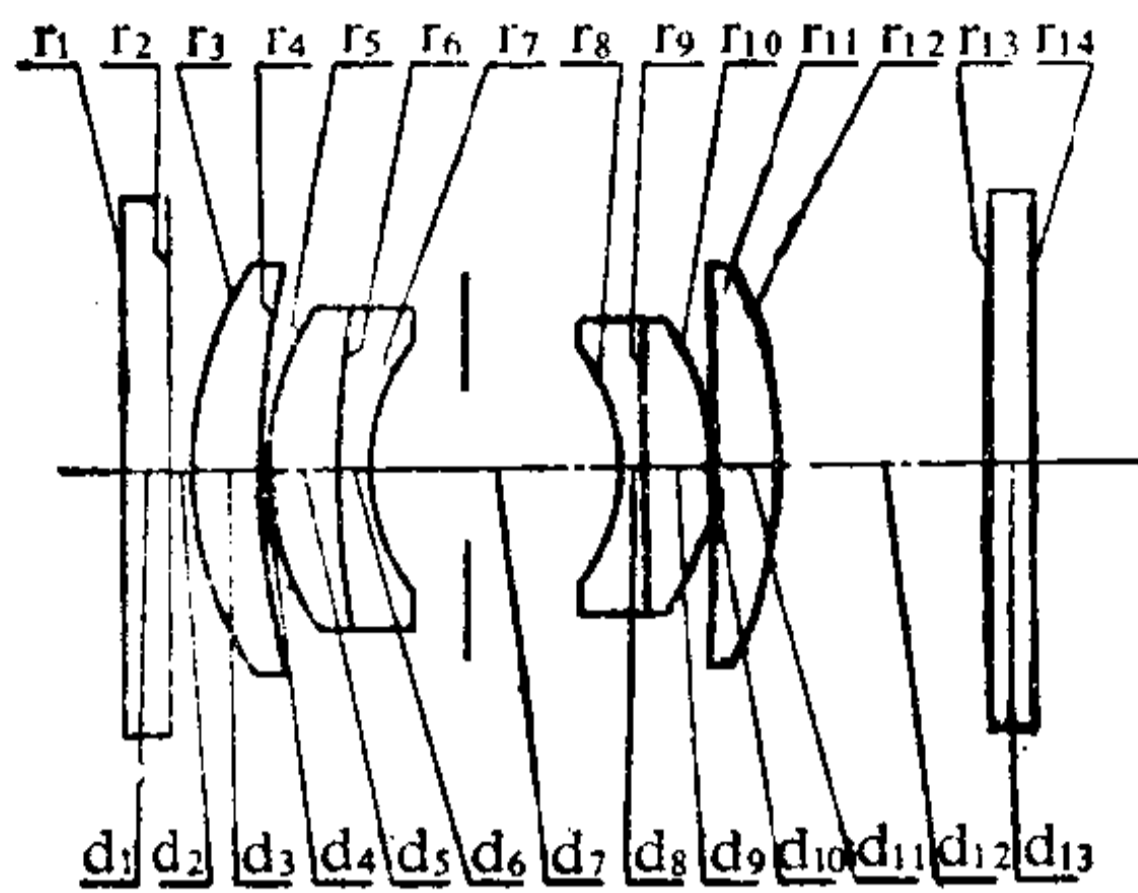

序号	r	d	n _D	v	序号	r	d	n _D	v
1	∞	4.000	1.5163	64.20	8	-16.41	2.000	1.6039	38.02
2	∞	2.000			9	-741.30	5.557	1.6591	50.88
3	32.80	6.000	1.5891	61.24	10	-22.85	0.200		
4	75.78	0.200			11	-345.40	5.500	1.5891	61.24
5	26.20	6.995	1.6591	50.88	12	-39.30	18.057		
6	84.00	2.500	1.6200	36.34	13	∞	3.810	1.5224	59.48
7	16.58	21.386*			14	∞			

$21.386^* = 8.550 + 12.836$

	ΣS_1	ΣS_2	ΣS_3	ΣS_4	ΣS_5	HI	QP (1 ω)
	-0.00065	-0.00068	0.00092	-0.00865	-0.03205	37.67	-1.19%
h 或 ω %	LA'	$\Delta H'$	x'_t	x'_s	$x'_t - x'_s$	K_{T1}	$K'_{T0.7}$
100	-0.0093	-0.4497	-0.9129	0.0242	-0.9371	-0.0236	-0.0131
70	-0.0146	-0.1118	-0.2907	-0.1508	-0.1399	-0.0069	-0.0044

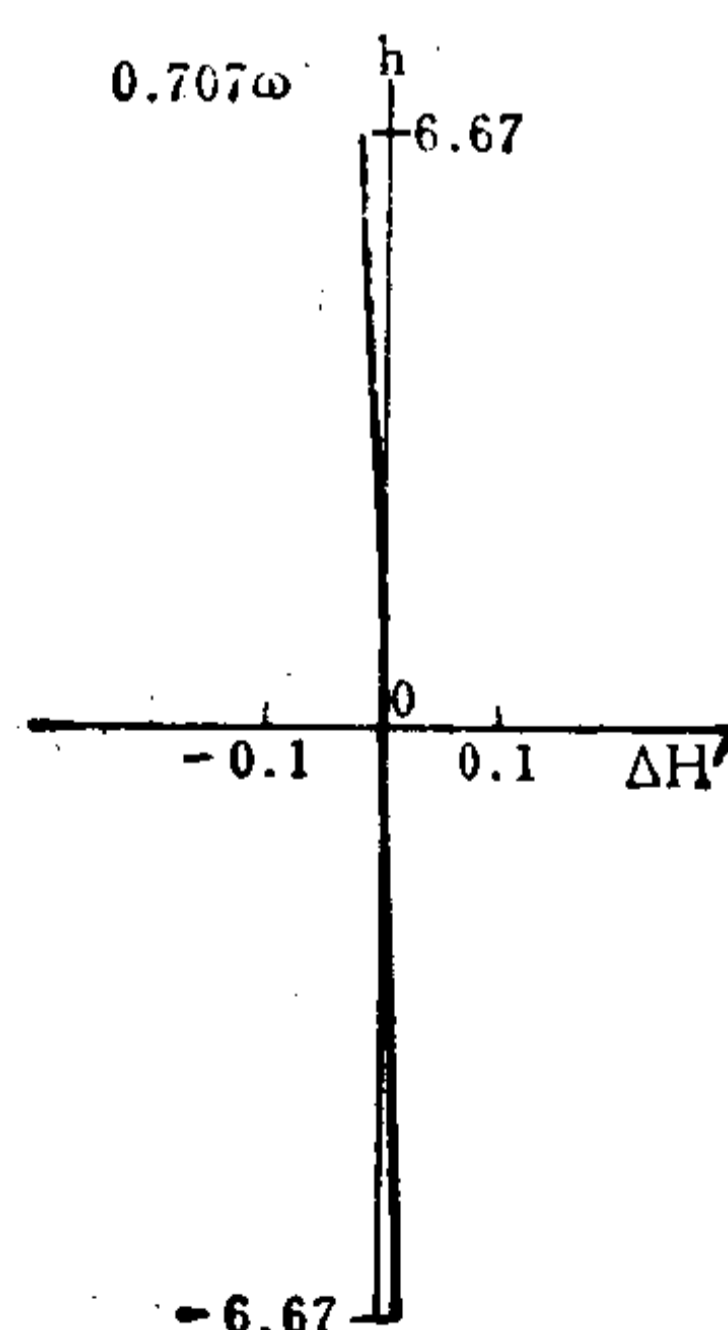
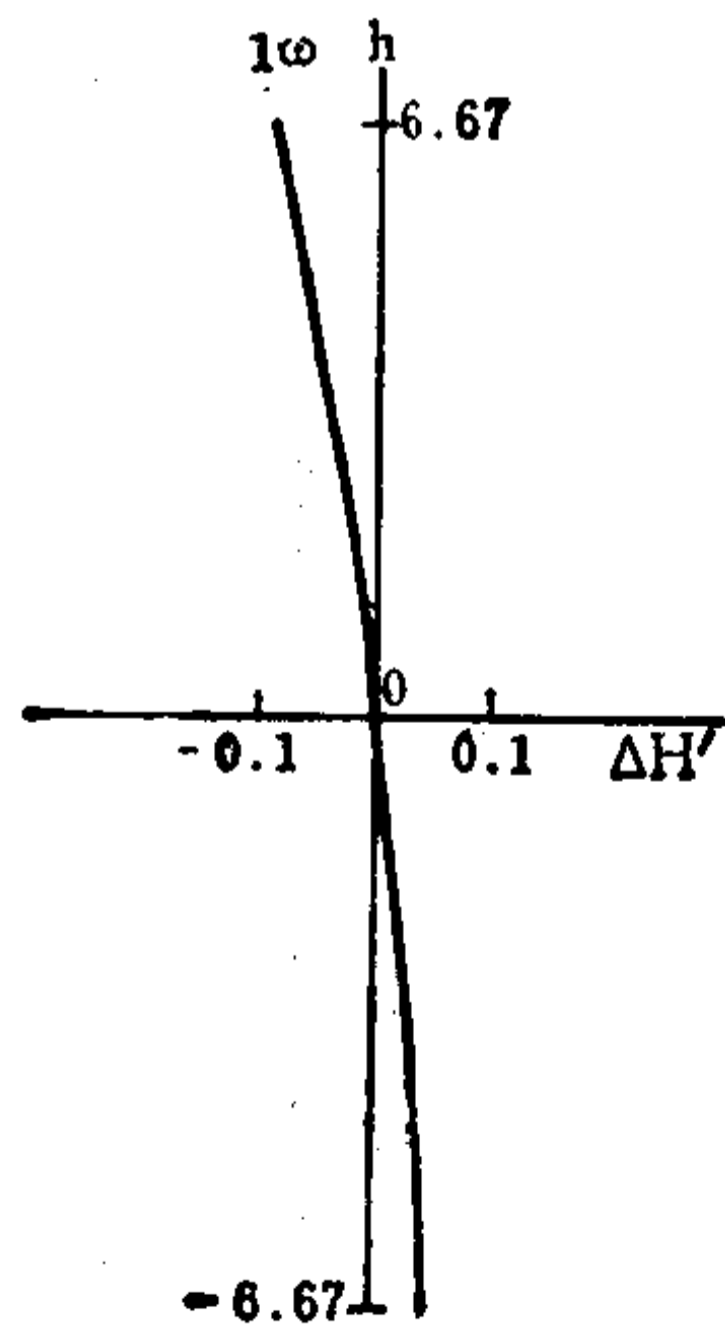
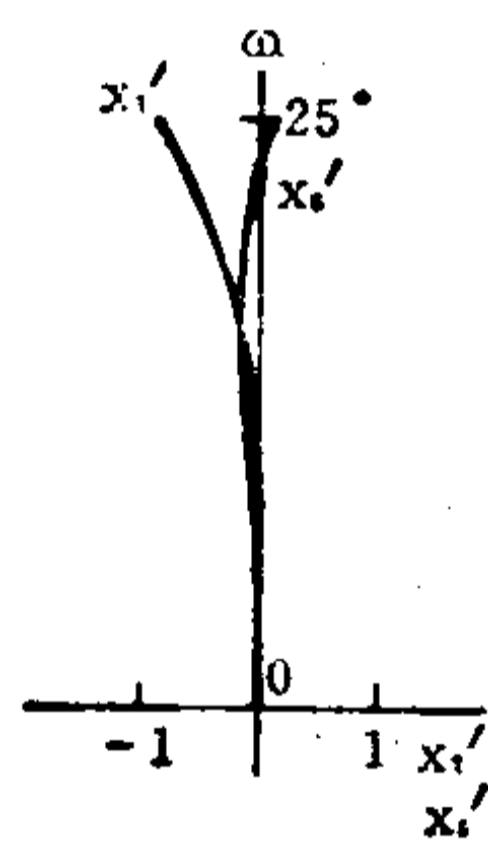
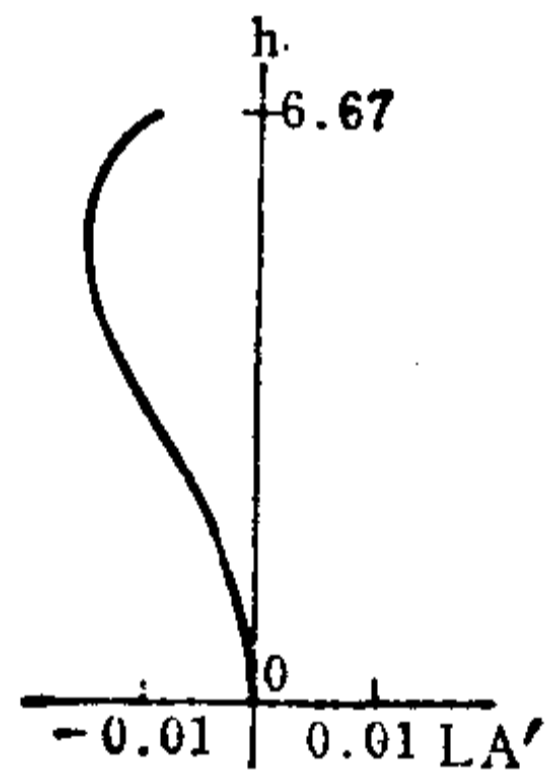

编号: 05-04-019

物 镜

E. F. L = 125

B. F. L = 28

FNo. = 6

F. A. = ± 16° **

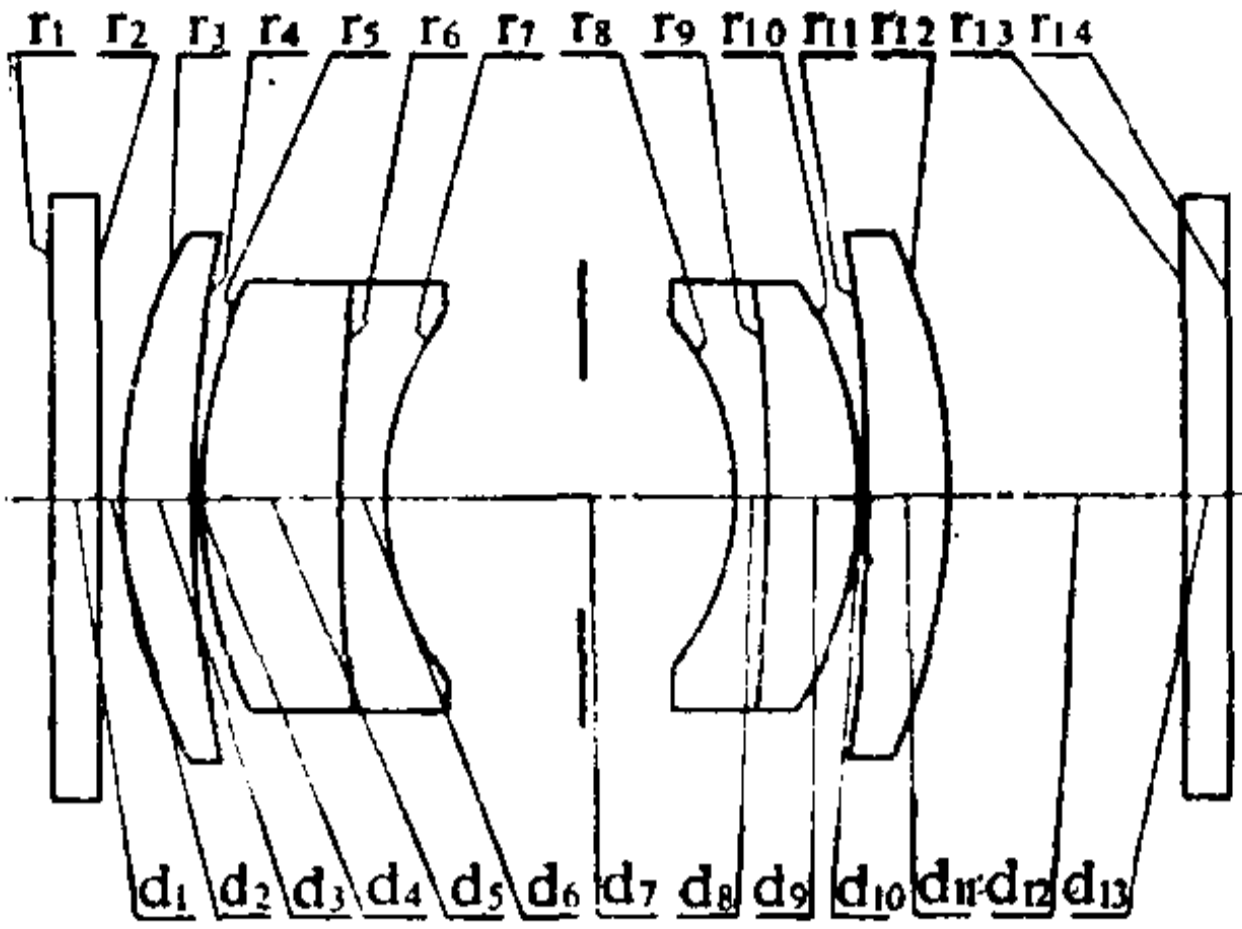

序号	r	d	n _D	v	序号	r	d	n _D	v
1	∞	4.000	1.5163	64.20	8	-23.50	3.000	1.6039	38.02
2	∞	2.000			9	-275.00	8.100	1.6591	50.88
3	48.83	5.900	1.5892	61.24	10	-33.18	0.215		
4	110.60	0.215			11	-398.00	6.970	1.5892	61.24
5	42.75	12.150	1.6591	50.88	12	-57.54	54.110		
6	150.50	3.860	1.6200	36.34	13	∞	3.810	1.5224	59.48
7	26.70	33.080*			14	∞			

33.080* = 12.950 + 20.130

	ΣS ₁	ΣS ₂	ΣS ₃	ΣS ₄	ΣS ₅	HI	QP (1ω)
	-0.00120	-0.00107	0.00088	-0.00402	-0.01332	35.79	-0.31%
h 或 ω %	LA'	ΔH'	x _t '	x _s '	x _t ' - x _s '	K _{T1}	K _{T0.7}
100	0.0028	-0.1124	-0.0399	-0.0518	0.0119	-0.0138	-0.0074
70	-0.0218	-0.0343	-0.0353	-0.0729	0.0376	-0.0118	-0.0059

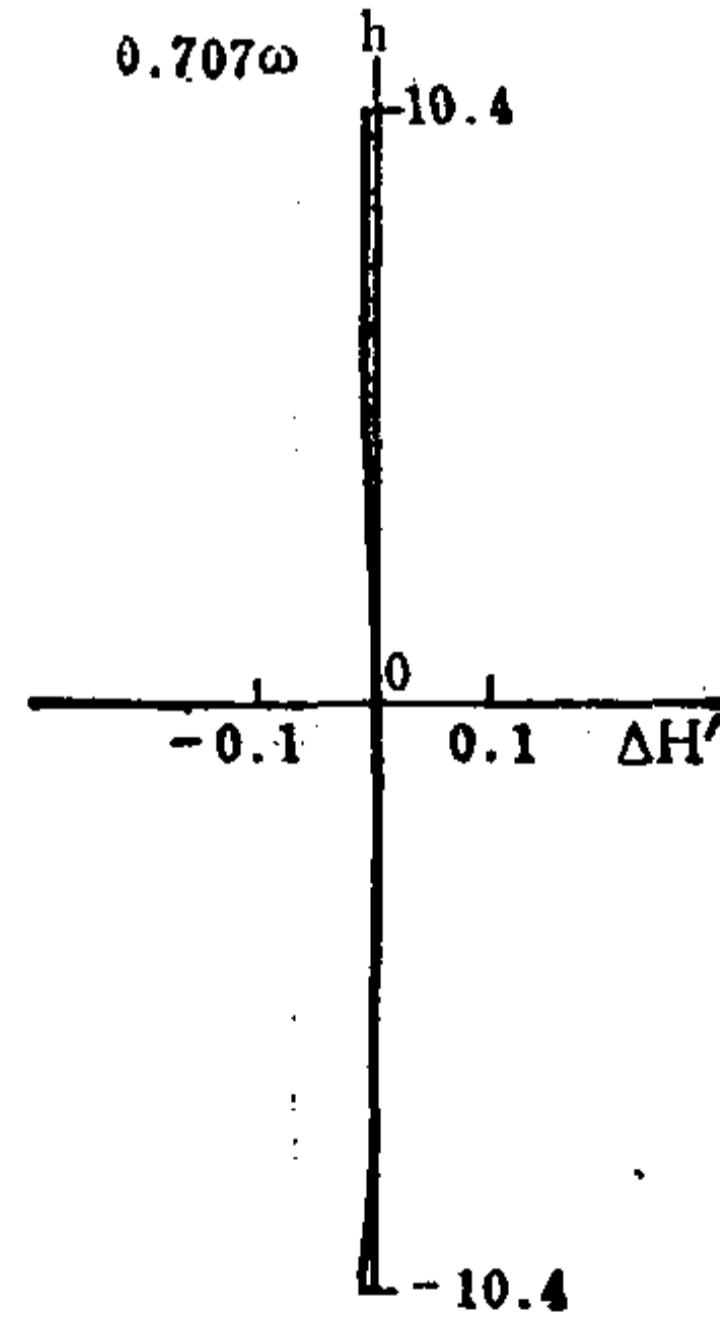
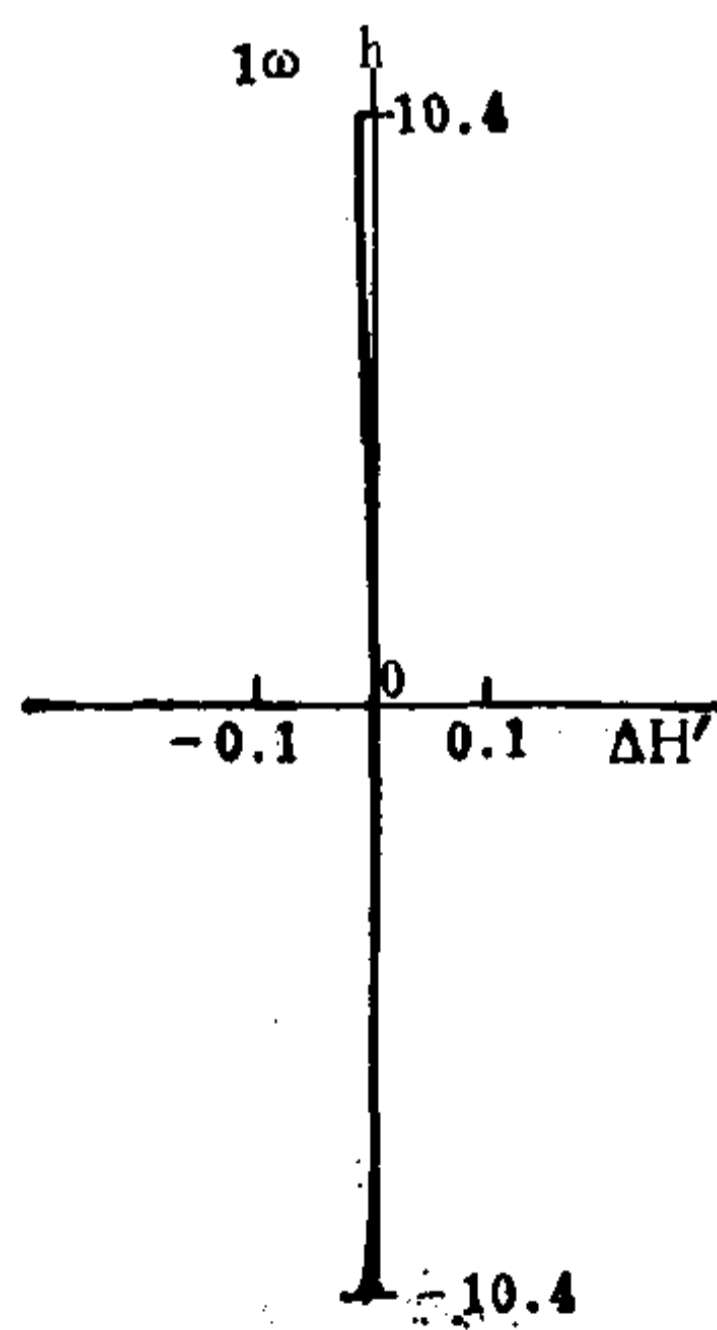
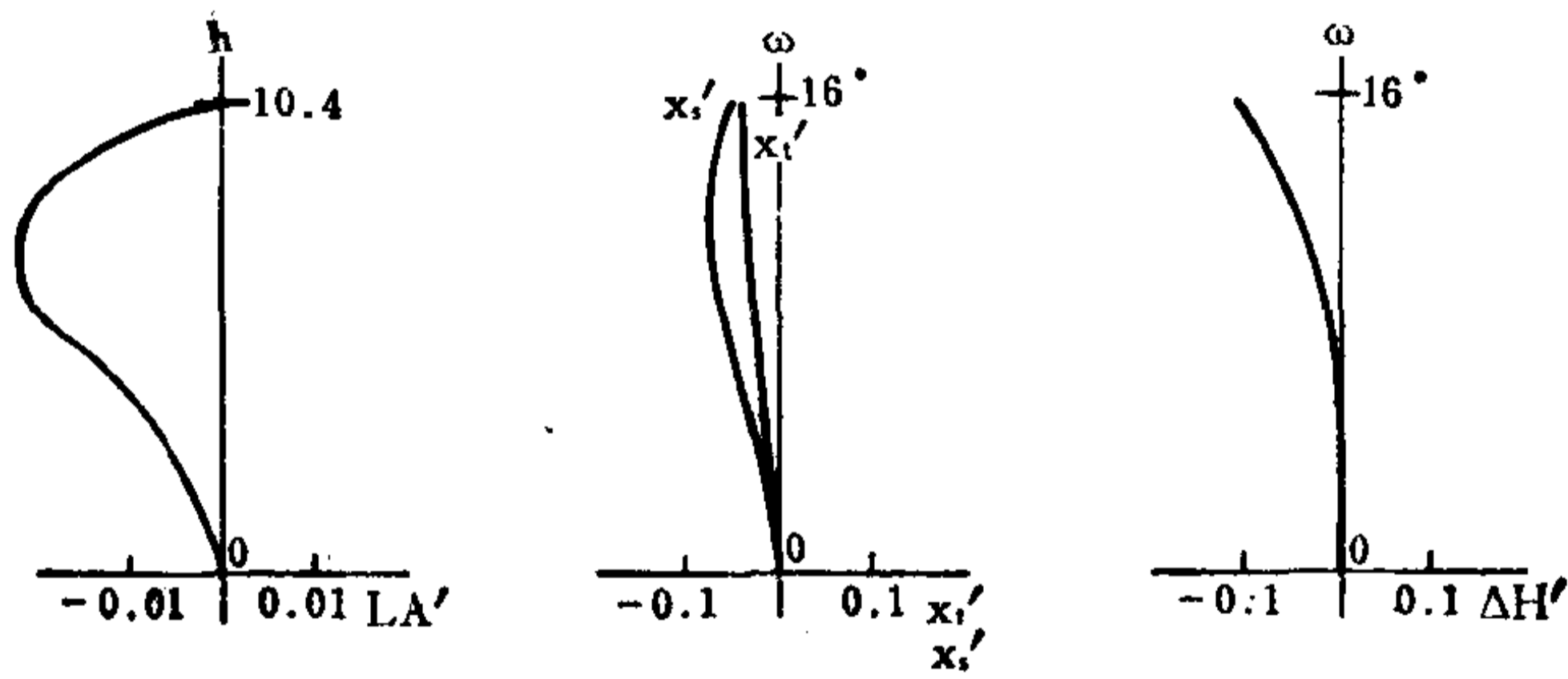

编号: 05-04-020

三组元物镜

E. F. L = 1.0

B. F. L = 0.7

FNo. = 2.8

F. A. = ± 15°

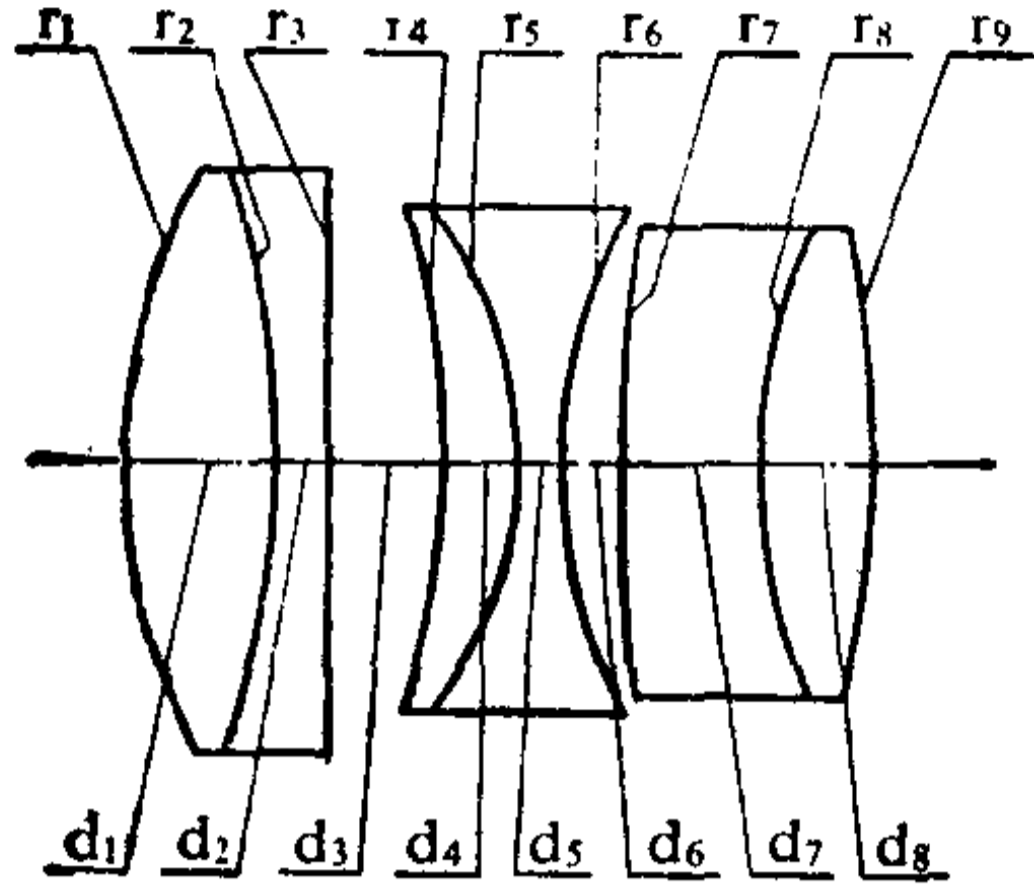

序号	r	d	n _e	v _e	序号	r	d	n _e	v _e
1	0.40218	0.1007	1.69282	49.45	6	0.34854	0.0372		
2	-0.59980	0.0325	1.59910	38.98	7	1.18706	0.0889	1.62767	36.51
3	6.40992	0.0724*			8	0.37699	0.0738	1.75480	39.54
4	-0.53278	0.0474	1.81140	31.02	9	-0.67400			
5	-0.26701	0.0345	1.69416	30.92					

0.0724* = 0.0400 + 0.0324

	ΣS ₁	ΣS ₂	ΣS ₃	ΣS ₄	ΣS ₅	HI	QP(1 ω)
	-0.000362	-0.000178	0.000035	-0.000477	0.000668	0.268	0.78%
h 或 ω %	LA'	ΔH'	x _t	x' _s	x _t - x' _s	K _{T1}	K _{T0.7}
100	-0.00043	0.00209	-0.0049	-0.0040	-0.0009	0.00359	0.00112
70	-0.00134	0.00071	-0.0026	-0.0028	0.0002	0.00054	0.00002

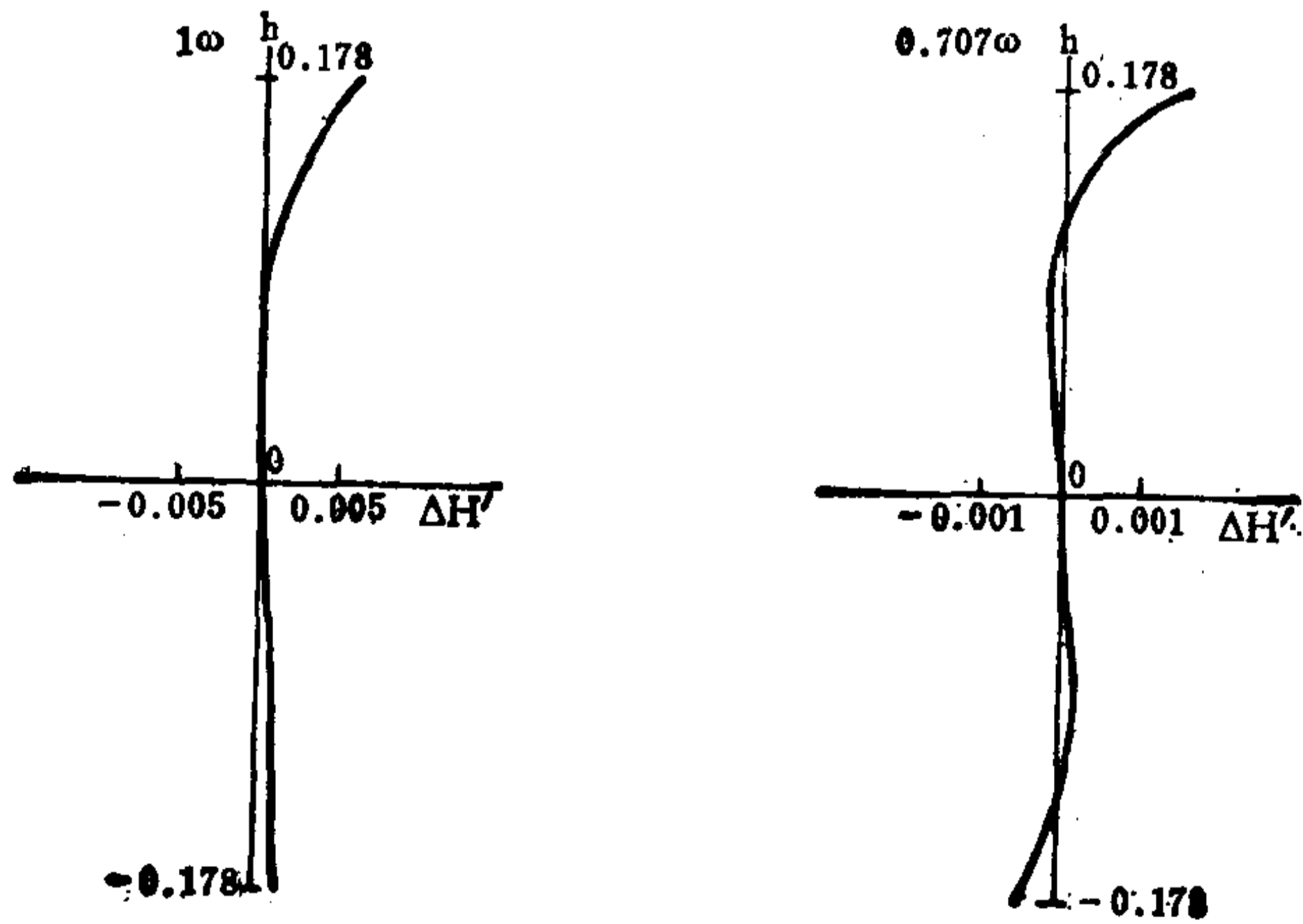
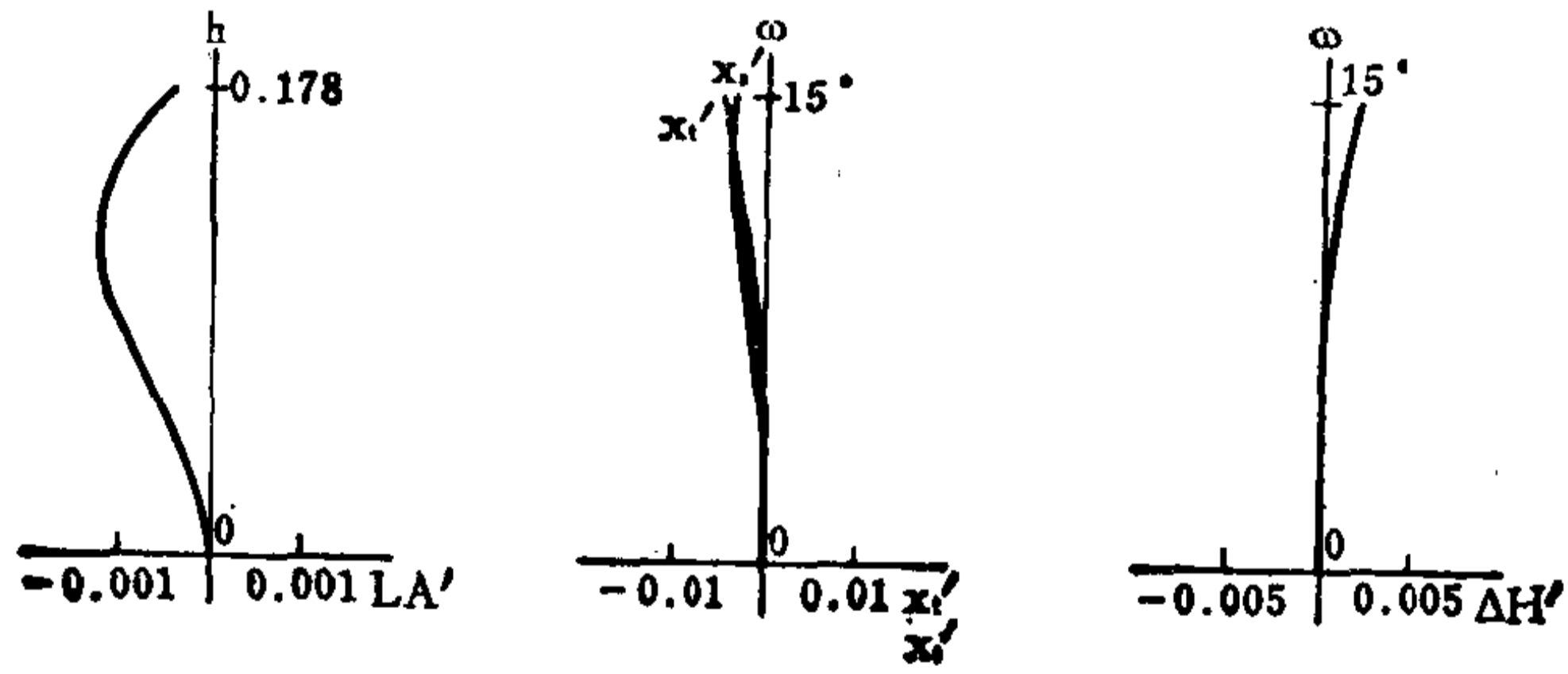

编号: 05-04-021

对称四组元摄影复印系统

E. F. L = 1.0

B. F. L = 0.8529

FNo. = 4.5

F. A. = ± 26.5°

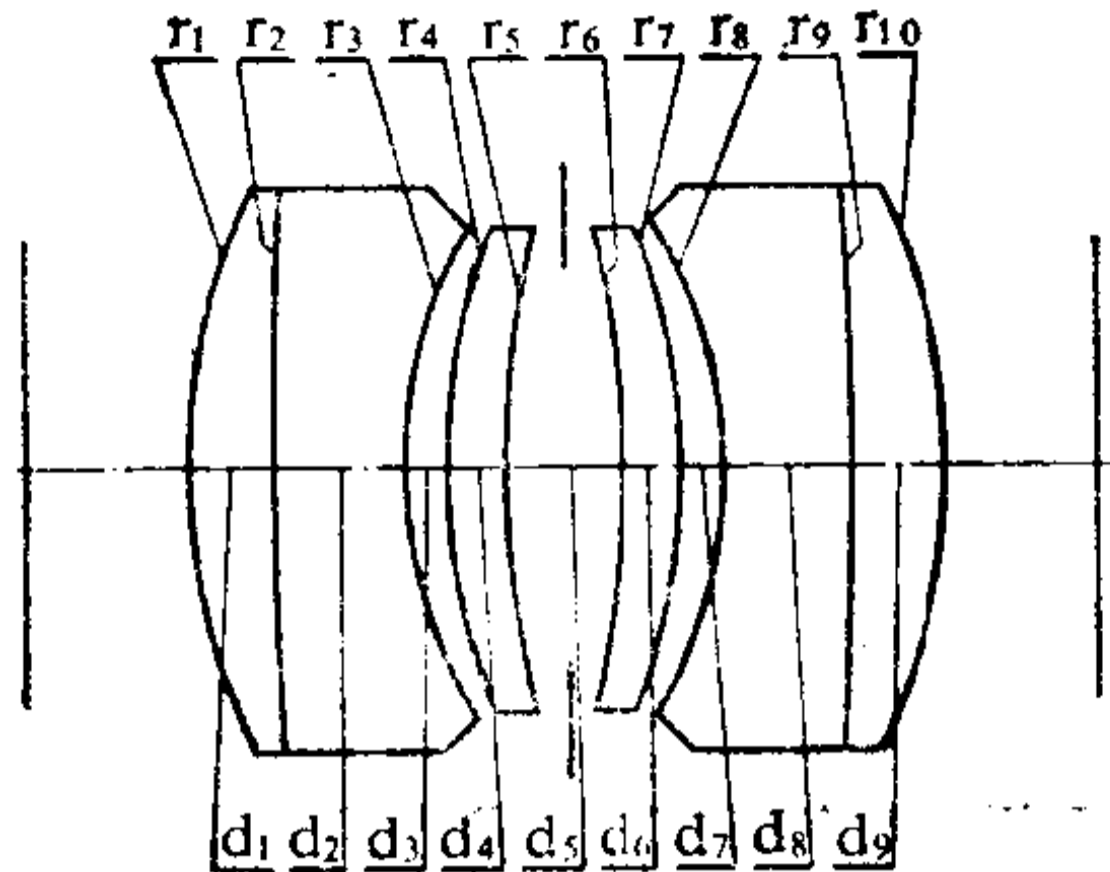

序号	r	d	nd	vd	序号	r	d	nd	vd
1	0.284724	0.038625	1.71700	47.9	6	-0.449099	0.024640	1.68578	44.0
2	2.017807	0.056605	1.62588	35.6	7	-0.298009	0.018313		
3	0.208707	0.018313			8	-0.208707	0.056605	1.62588	35.6
4	0.298009	0.024640	1.68578	44.0	9	-2.017807	0.038625	1.71700	47.9
5	0.449099	0.047282*			10	-0.284724			

0.047282* = 0.023641 + 0.023641

	ΣS_1	ΣS_2	ΣS_3	ΣS_4	ΣS_5	HI	QP(1 ω)
	-0.000205	-0.000245	-0.000037	-0.000312	0.000180	0.497	0.27%
h 或 ω %	LA'	$\Delta H'$	x'_t	x'_s	$x'_t - x'_s$	K'_{T1}	$K'_{T0.7}$
100	0.00406	0.00132	-0.00109	-0.00109	0	-0.00304	-0.00196
70	-0.00157	0.00038	-0.00578	-0.00463	-0.00115	-0.00332	-0.00142

注: 以上象差值是按 $l = -\infty$ 计算的。

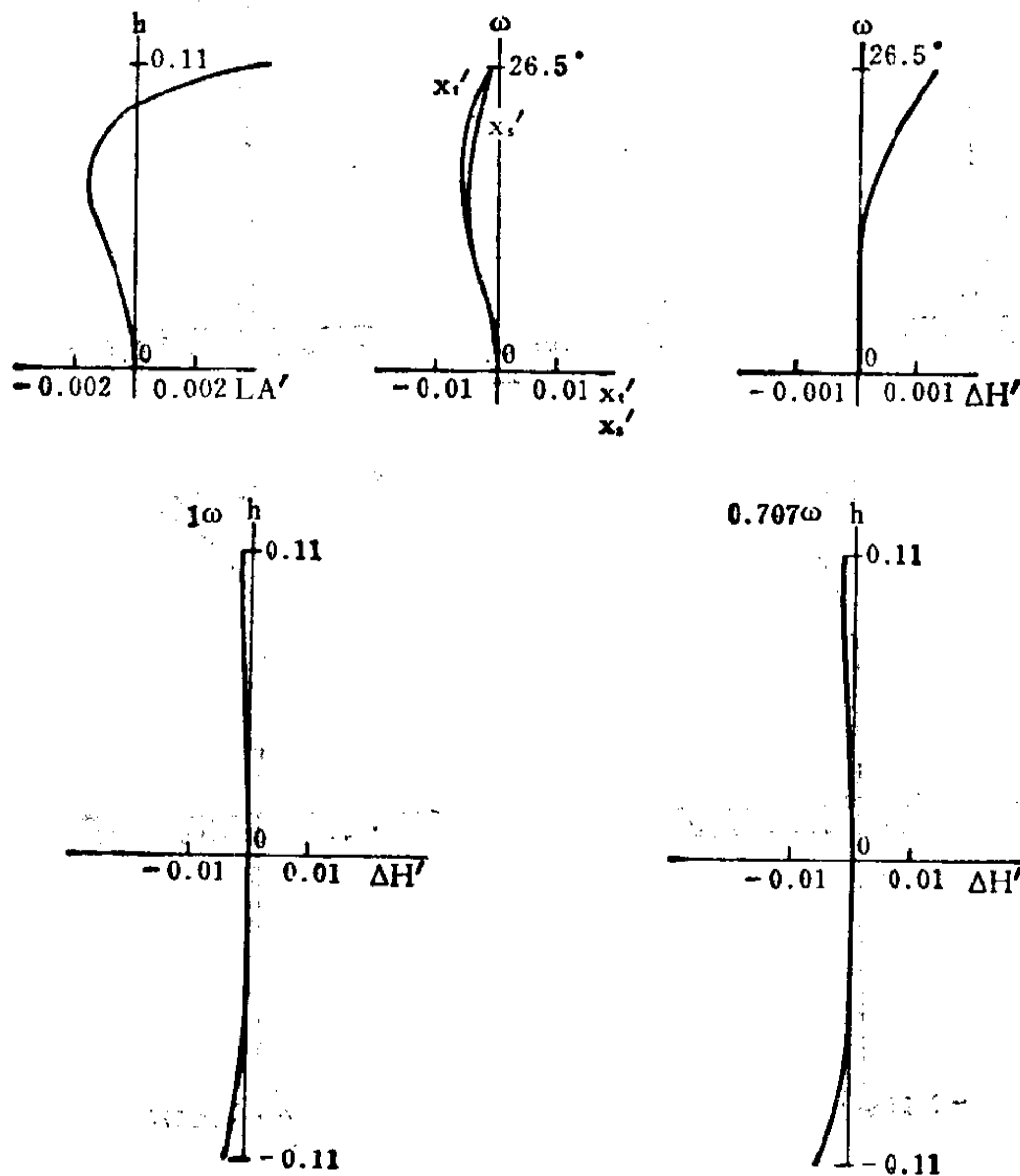

对于无限远和1:1光学放大率之间的大变化的物距上,
有一个近似不变的高性能图象的四组元物镜

E. F. L = 100

B. F. L = 71.3

FNo. = 4.8

F. A. = $\pm 20^{\circ}$ **

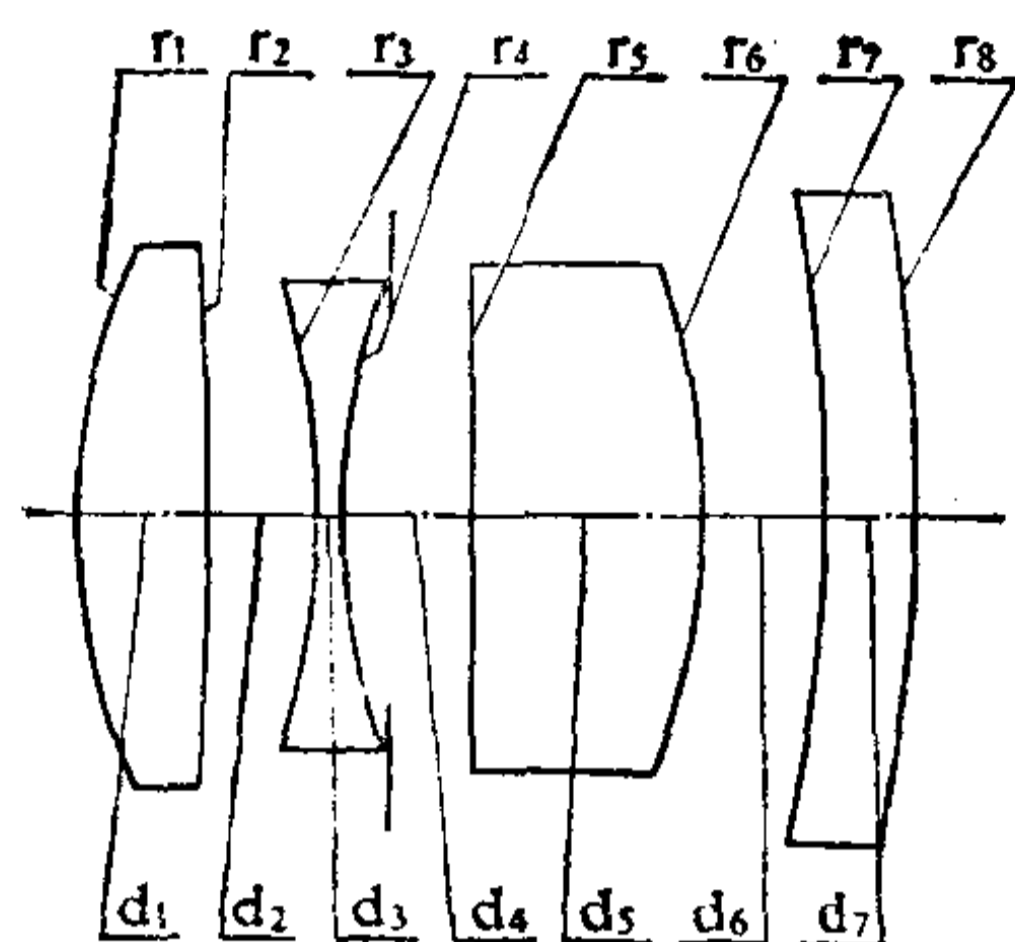

序号	r	d	n _d	v	序号	r	d	n _d	v
1	42.745	8.177	1.6933	51.56	5	19212.100	14.750	1.6405	60.10
2	-260.615	6.938			6	-48.388	7.796		
3	-58.076	1.588	1.6461	34.05	7	-169.419	6.033	1.5168	64.17
4	43.875	8.431*			8	-116.875			

8.431* = 2.000 + 6.431

	ΣS_1	ΣS_2	ΣS_3	ΣS_4	ΣS_5	HI	QP(1 ω)
	-0.0088	-0.0074	0.0192	-0.0561	0.0146	36.40	0.56%
h 或 ω %	LA'	$\Delta H'$	x'_t	x'_s	$x'_t - x'_s$	K'_{T1}	$K'_{T0.7}$
100	-0.169	0.205	-0.968	-1.315	0.347	-0.0079	0.0003
70	-0.148	0.044	-0.096	-0.788	0.692	-0.0967	-0.0392

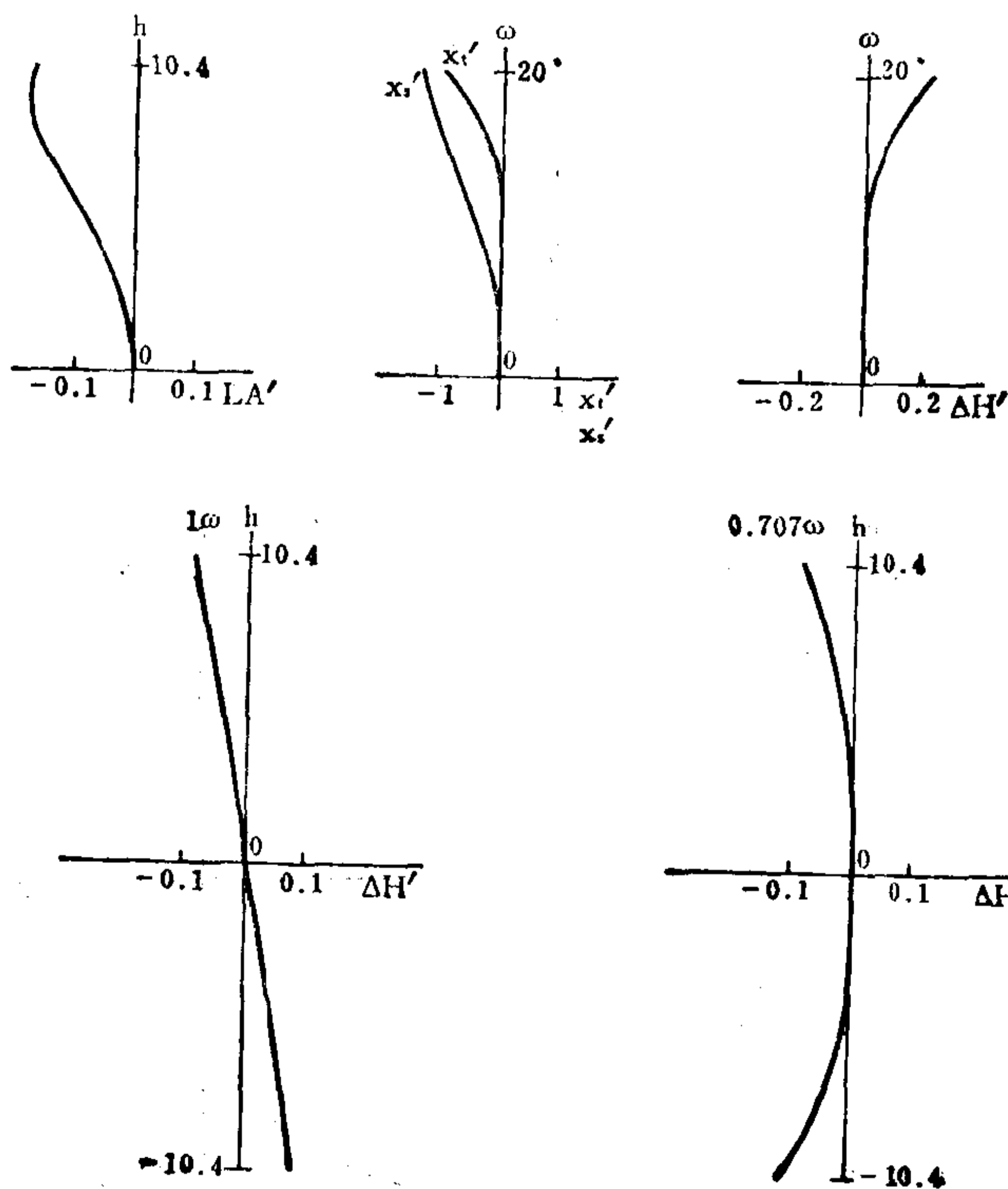

对于无限远和1:1光学放大率之间的大变化的物距上, 有一个近似不变的高性能图象的四组元物镜

E. F. L = 100

B. F. L = 68.6

FNo. = 3.9

F. A. = $\pm 20^{\circ}$ **

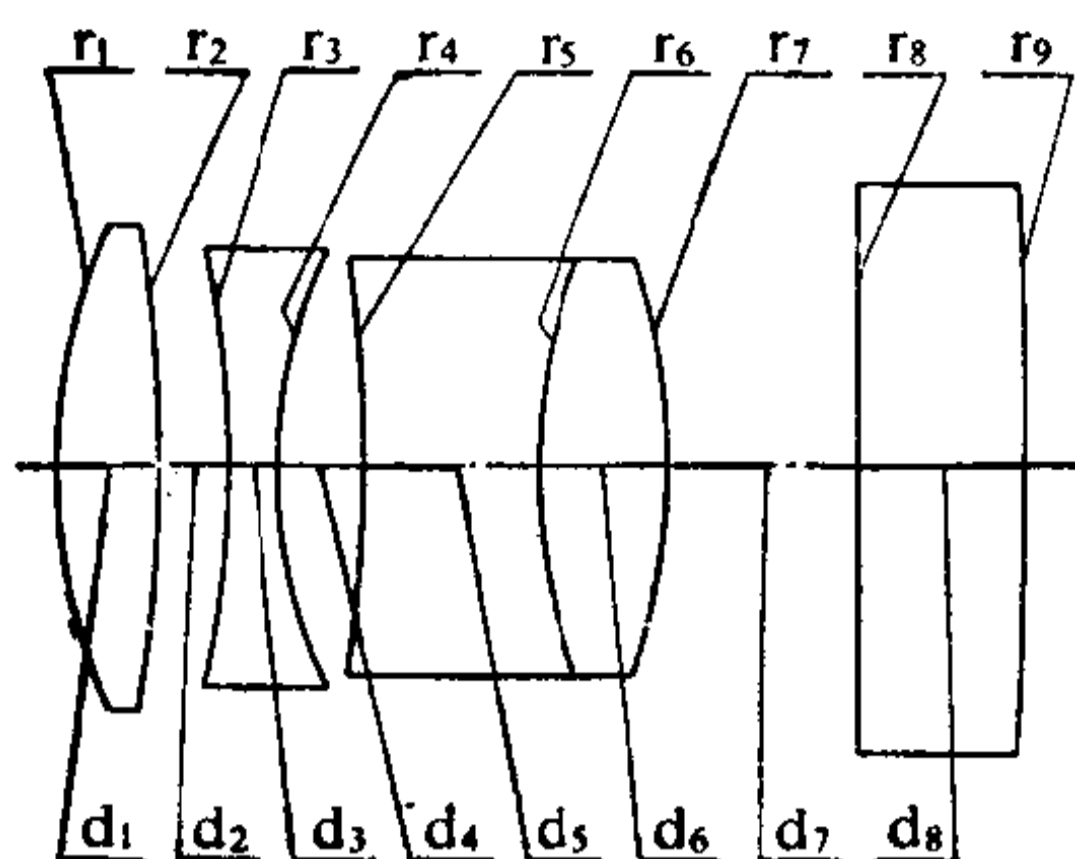

序号	r	d	n _d	v	序号	r	d	n _d	v
1	38.2267	6.467	1.71700	48.0	6	43.1965	8.083	1.64050	60.1
2	-170.7530	4.558			7	-45.4368	12.124		
3	-57.6119	3.346	1.62237	36.0	8	-4253.2700	10.734	1.51009	63.5
4	31.9357	5.436*			9	-390.6520			
5	-122.6970	11.640	1.52341	51.5					

5.436* = 1.436 + 4.000

注: 第三片和第四片采用光胶。

	ΣS_1	ΣS_2	ΣS_3	ΣS_4	ΣS_5	HI	QP(1 ω)
	-0.0285	-0.0123	0.0201	-0.0453	-0.0849	36.38	-0.89%
h 或 ω %	LA'	$\Delta H'$	x'_i	x'_s	$x'_i - x'_s$	K'_{T1}	$K'_{T0.7}$
100	0.3299	-0.3256	-1.553	-0.353	-1.200		-0.0077
70	-0.1816	-0.1217	-0.107	-0.295	0.188	-0.2026	-0.0700

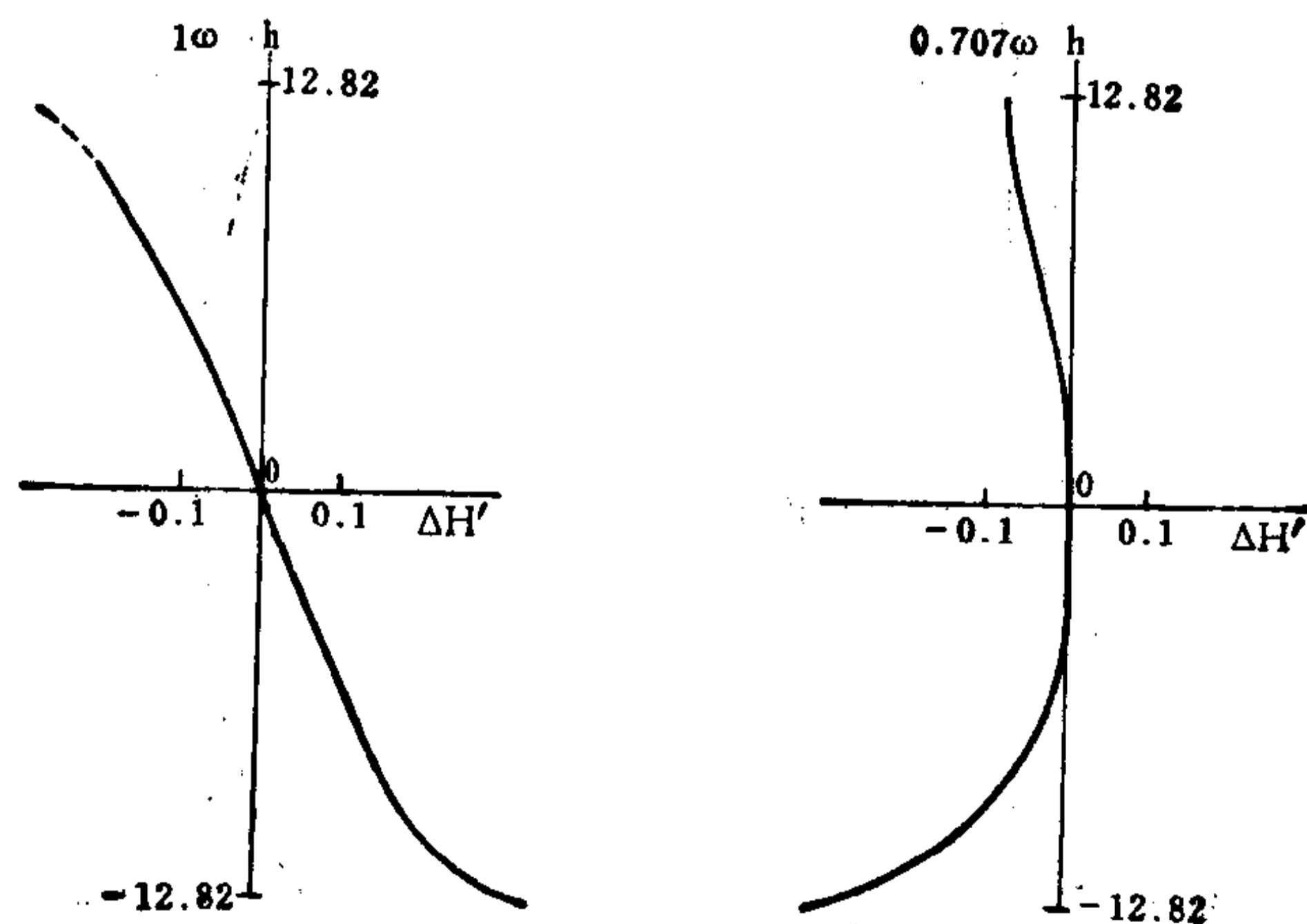
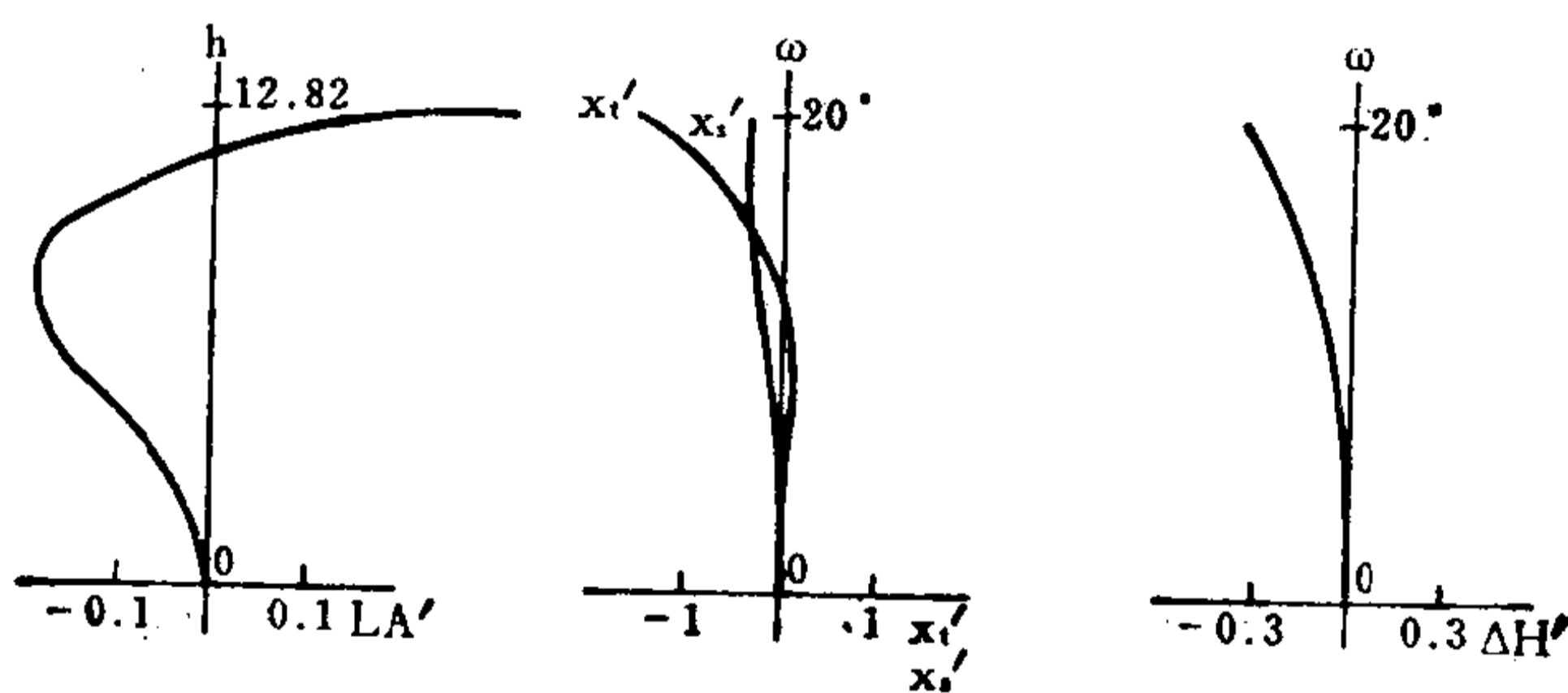

编号: 05-04-024

摄影物镜

E. F. L = 1.0

B. F. L = 0.79

FNo. = 2.8

F. A. = $\pm 30^\circ$

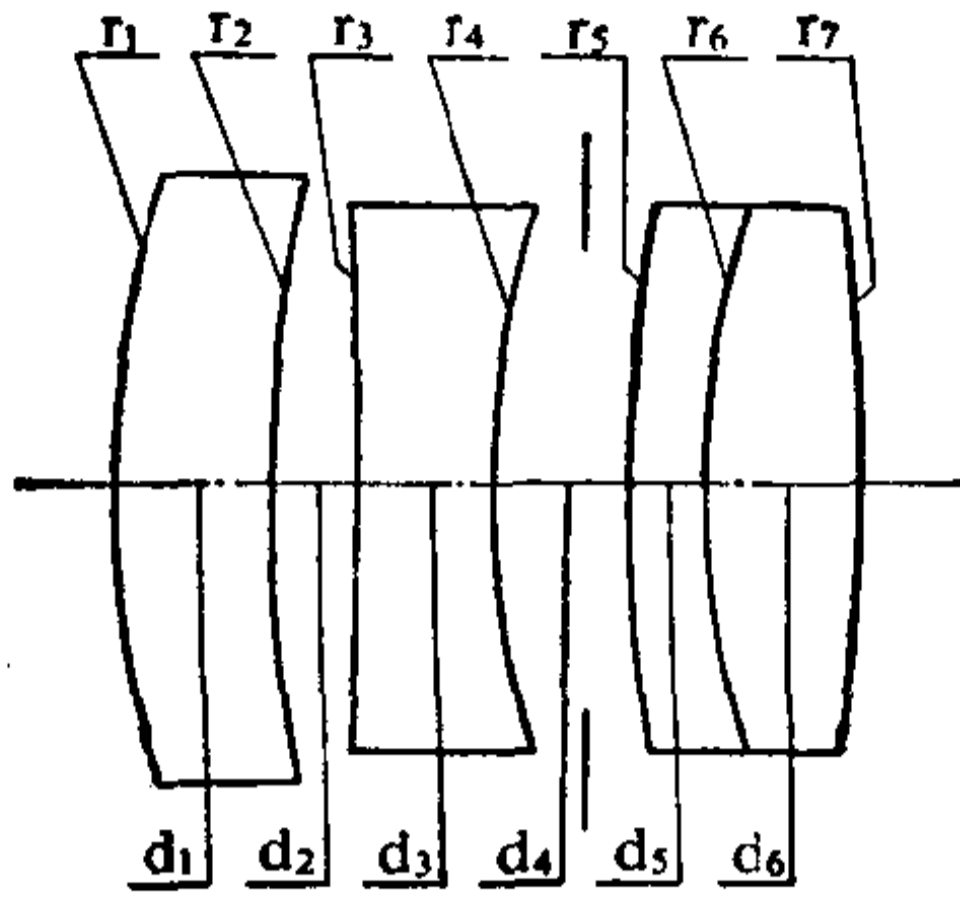

序号	r	d	n_d	v	序号	r	d	n_d	v
1	0.3308	0.100	1.80420	46.6	5	1.2015	0.025	1.72825	28.3
2	0.9499	0.027			6	0.3308	0.100	1.83060	36.5
3	-2.8539	0.045	1.75690	31.7	7	-0.9269			
4	0.3074	0.042*							

$0.042^* = 0.030 + 0.012$

	ΣS_1	ΣS_2	ΣS_3	ΣS_4	ΣS_5	HI	QP(1 ω)
	-0.00080	0.00011	-0.00025	-0.00209	0.00193	0.58	-0.18%
h 或 ω %	LA'	$\Delta H'$	x'_t	x'_s	$x'_t - x'_s$	K'_{T1}	$K'_{T0.7}$
100	0.0150	-0.0010	-0.0507	-0.0097	-0.0410	-0.0259	0.00210
70	-0.0015	0.0012	-0.0204	-0.0140	-0.0064	-0.0013	0.00169

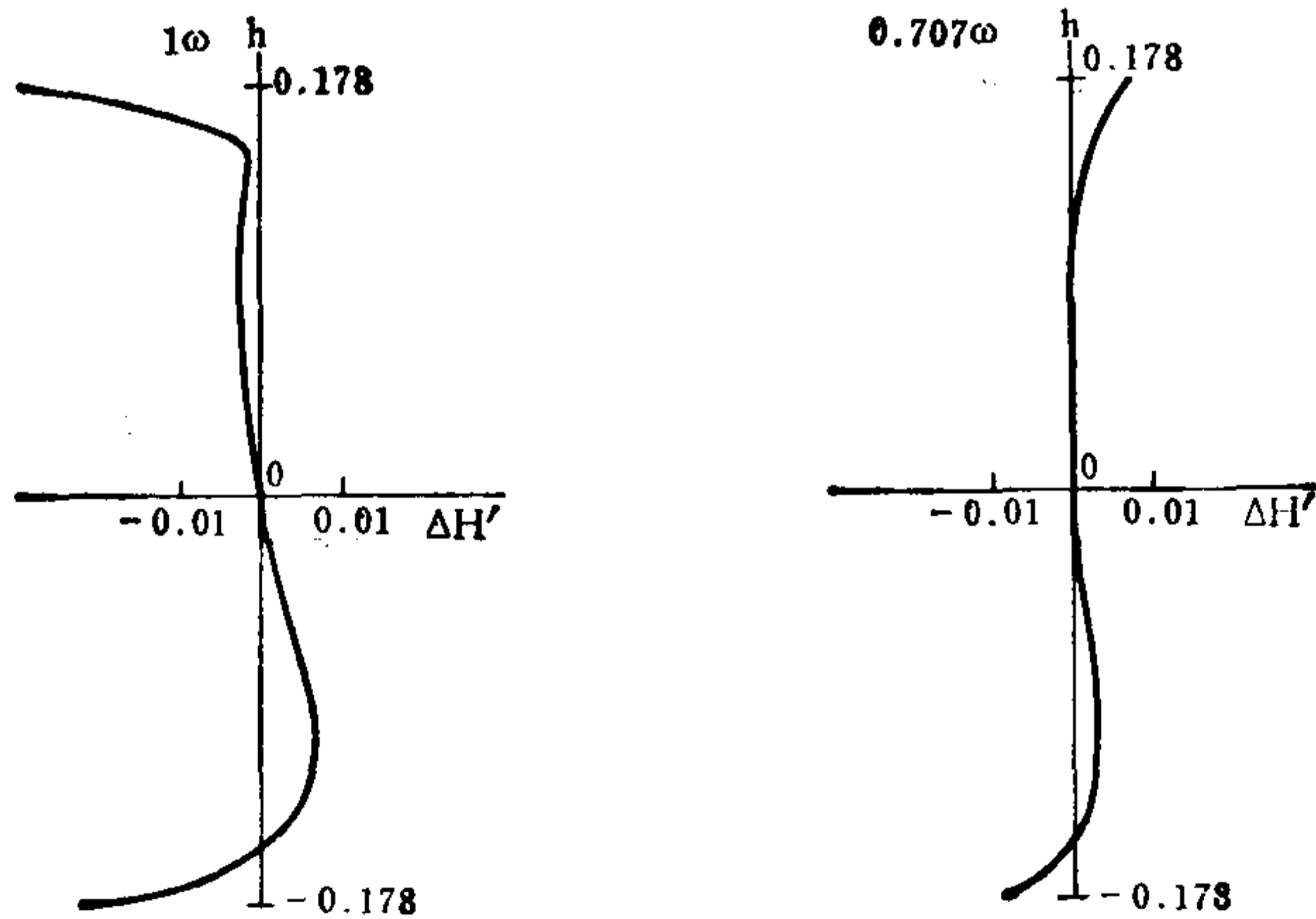
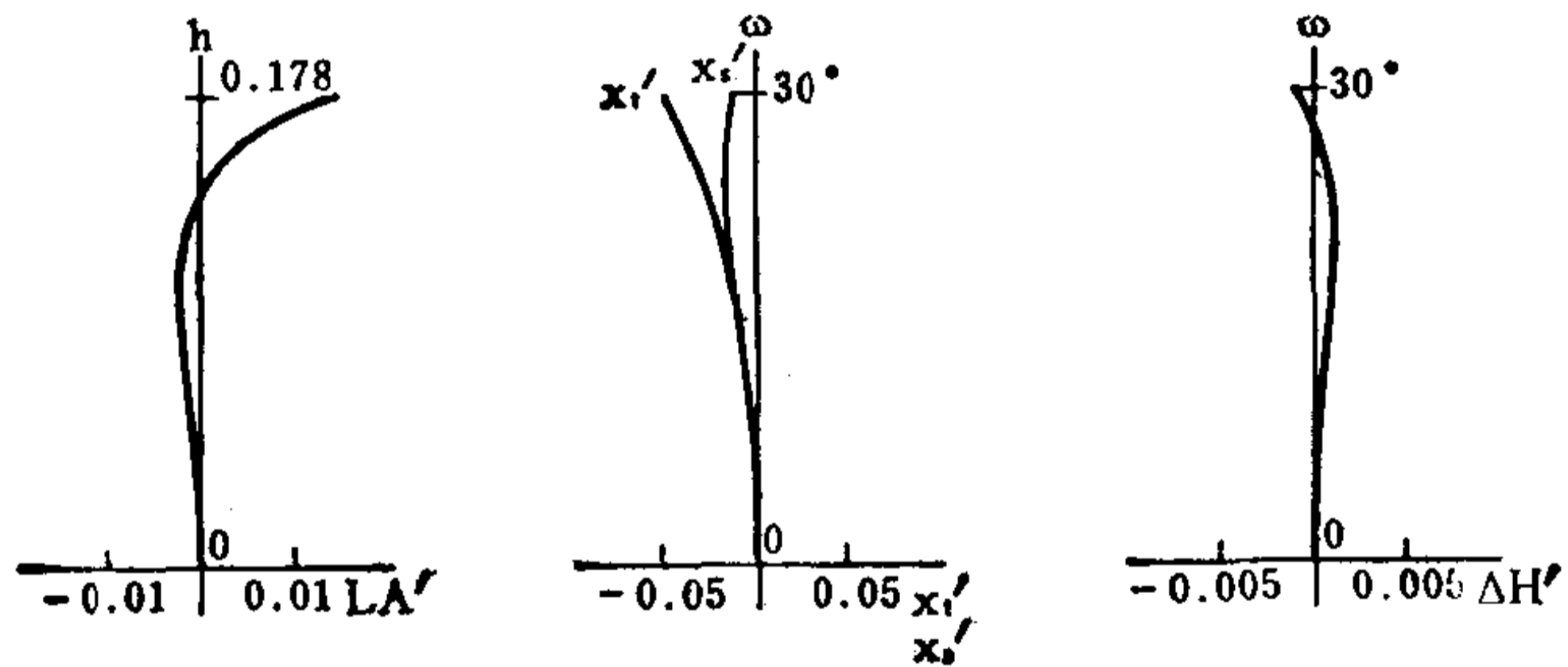

编号: 05-04-025

带有后光栏的摄影物镜

E.F.L=99.8 B.F.L=88.3 FNo.=6.8 F.A.=±10°** L'p5=12.000

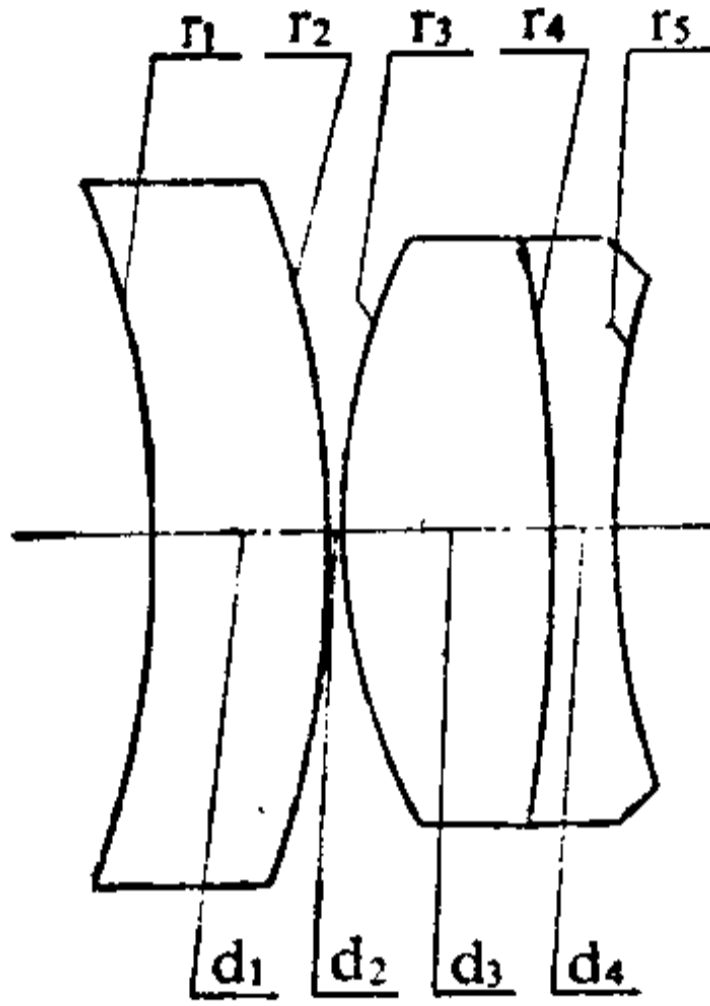

序号	r	d	n _d	v	序号	r	d	n _d	v
1	-41.782	7.510	1.52300	59.50	4	-64.063	2.692	1.62004	36.37
2	-42.684	0.250			5	38.803			
3	27.037	9.012	1.60738	56.65					

	ΣS_1	ΣS_2	ΣS_3	ΣS_4	ΣS_5	HI	QP(1 ω)
	-0.04333	0.00114	0.00068	-0.00629	0.01478	17.61	0.58%
h 或 ω %	LA'	$\Delta H'$	x'_t	x'_s	$x'_t - x'_s$	K'_{T1}	$K'_{T0.7}$
100	-3.946	0.102	-0.317	-0.511	0.194	0.0451	0.0203
70	-1.985	0.036	-0.179	-0.259	0.080	0.0274	0.0124

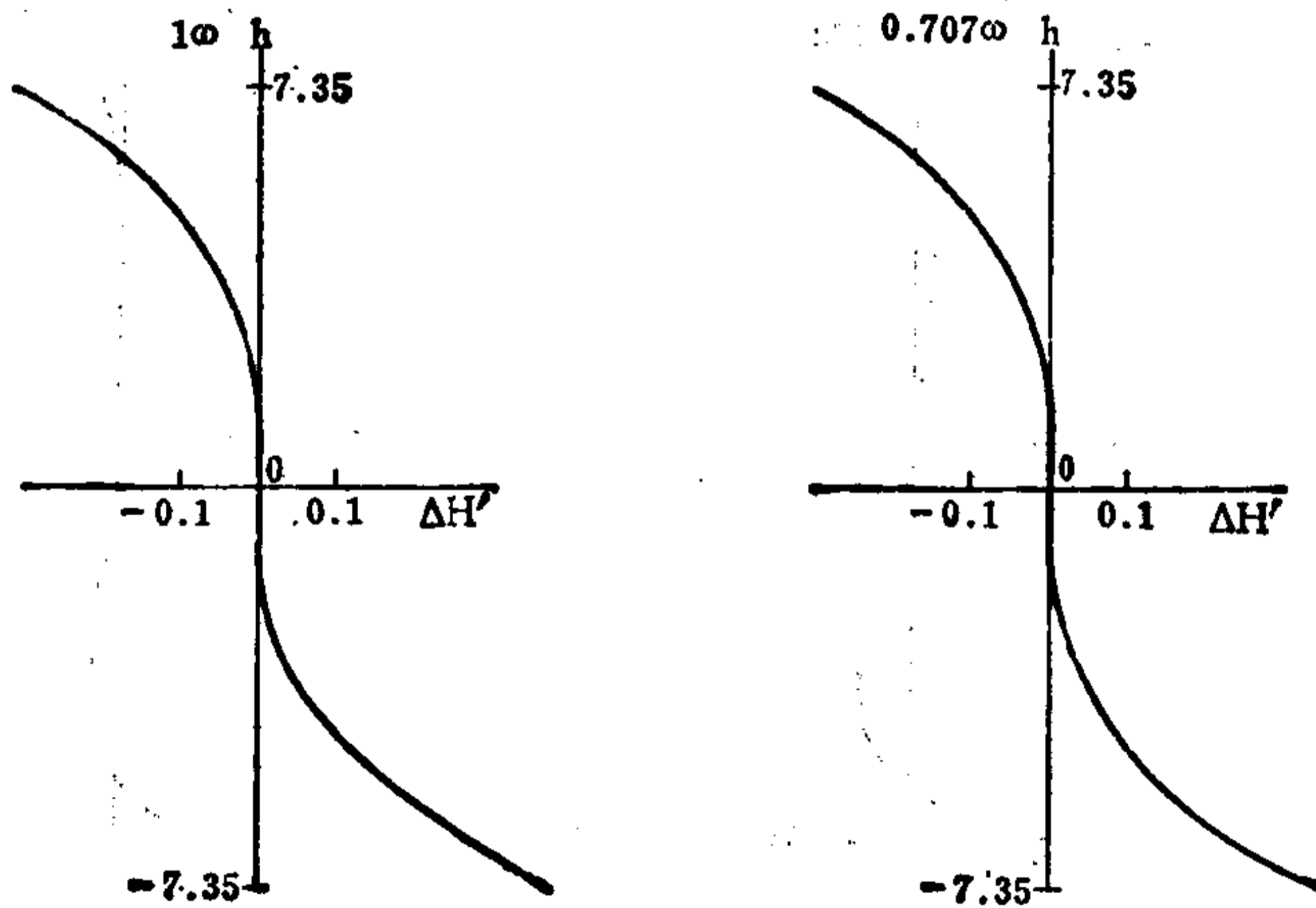
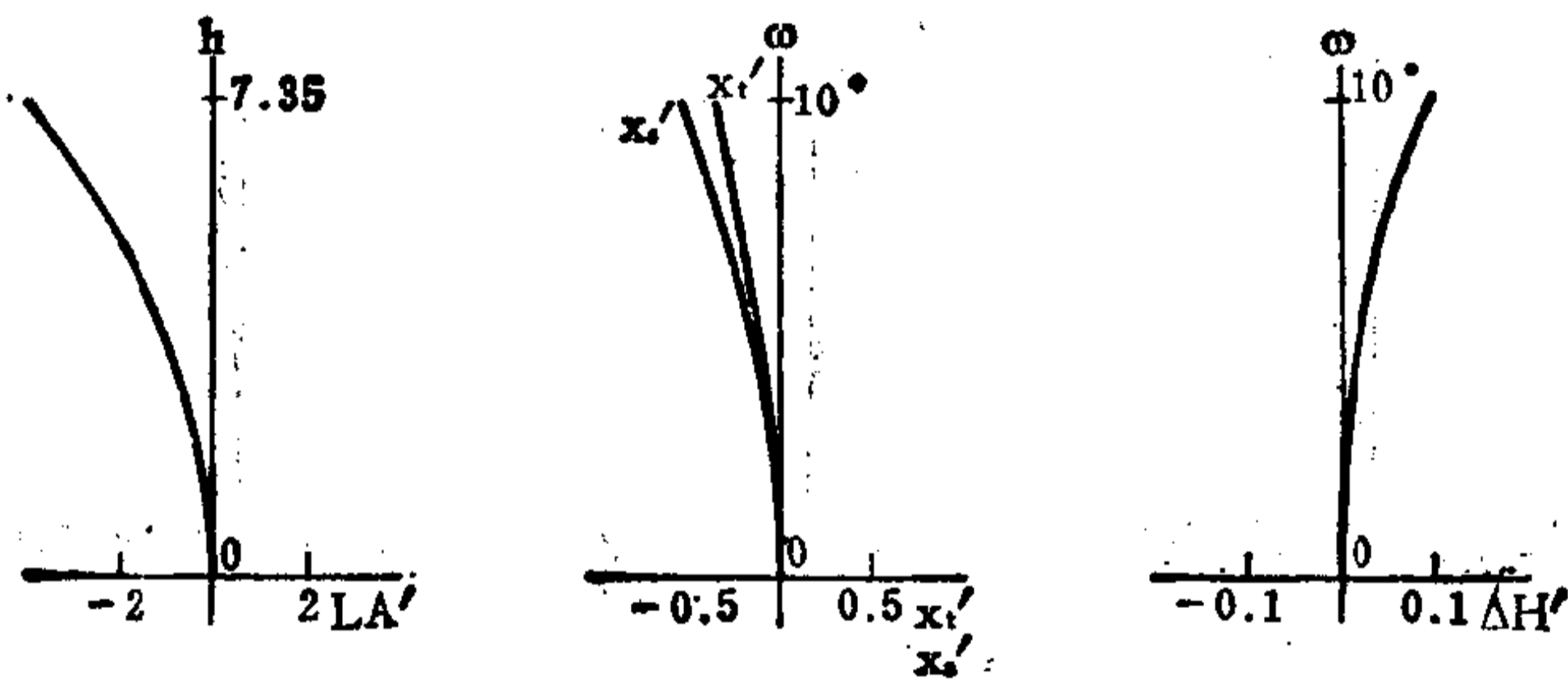

编号: 05-04-026

带有后光栏的摄影物镜

E. F. L = 100 B. F. L = 85.9 FNo. = 8 F. A. = $\pm 10^\circ$ ** $L'_{p5} = 10.00$

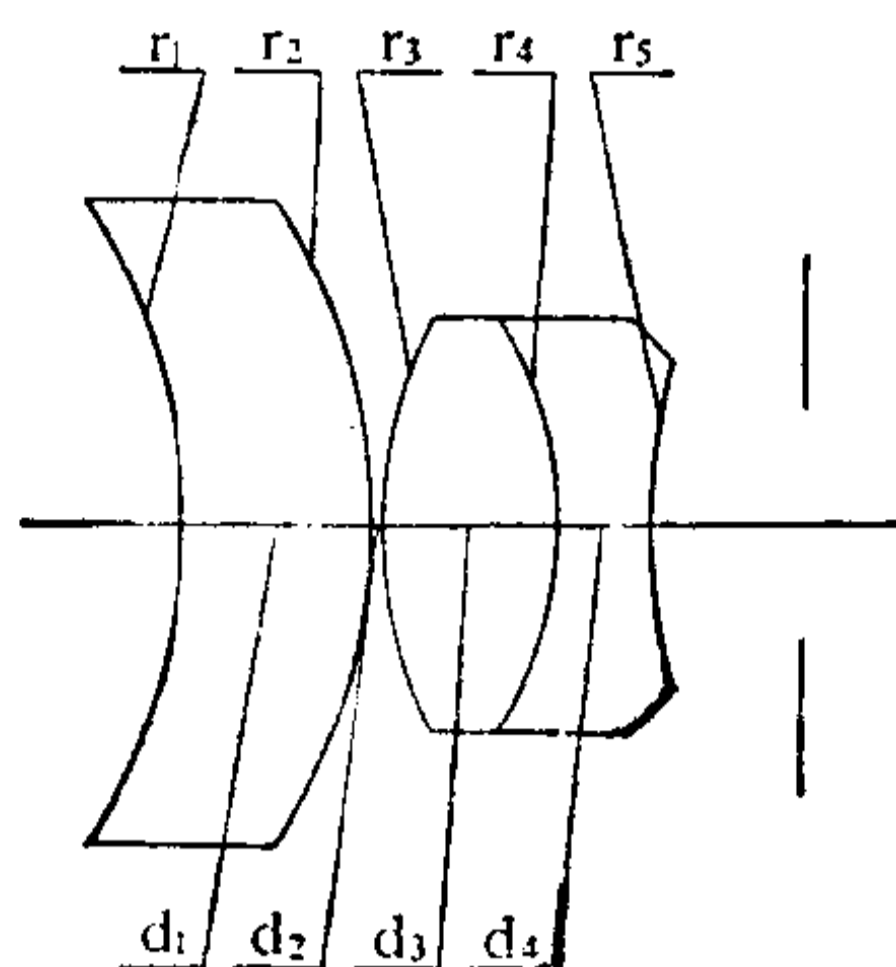

序号	r	d	n_d	ν	序号	r	d	n_d	ν
1	-38.373	12.11	1.52249	59.40	4	-25.430	5.75	1.62004	36.37
2	-39.249	0.61			5	40.729			
3	30.004	11.34	1.60729	49.40					

	ΣS_1	ΣS_2	ΣS_3	ΣS_4	ΣS_5	HI	QP(1 ω)
	-0.01841	0.00115	-0.00016	-0.00330	0.01006	17.64	0.45%
h 或 ω %	LA'	$\Delta H'$	x'_t	x'_s	$x'_t - x'_s$	K'_{T1}	$K'_{T0.7}$
100	-2.303	0.079	-0.418	-0.429	0.011	0.0382	0.0210
70	-1.165	0.028	-0.229	-0.220	-0.009	0.0239	0.0129

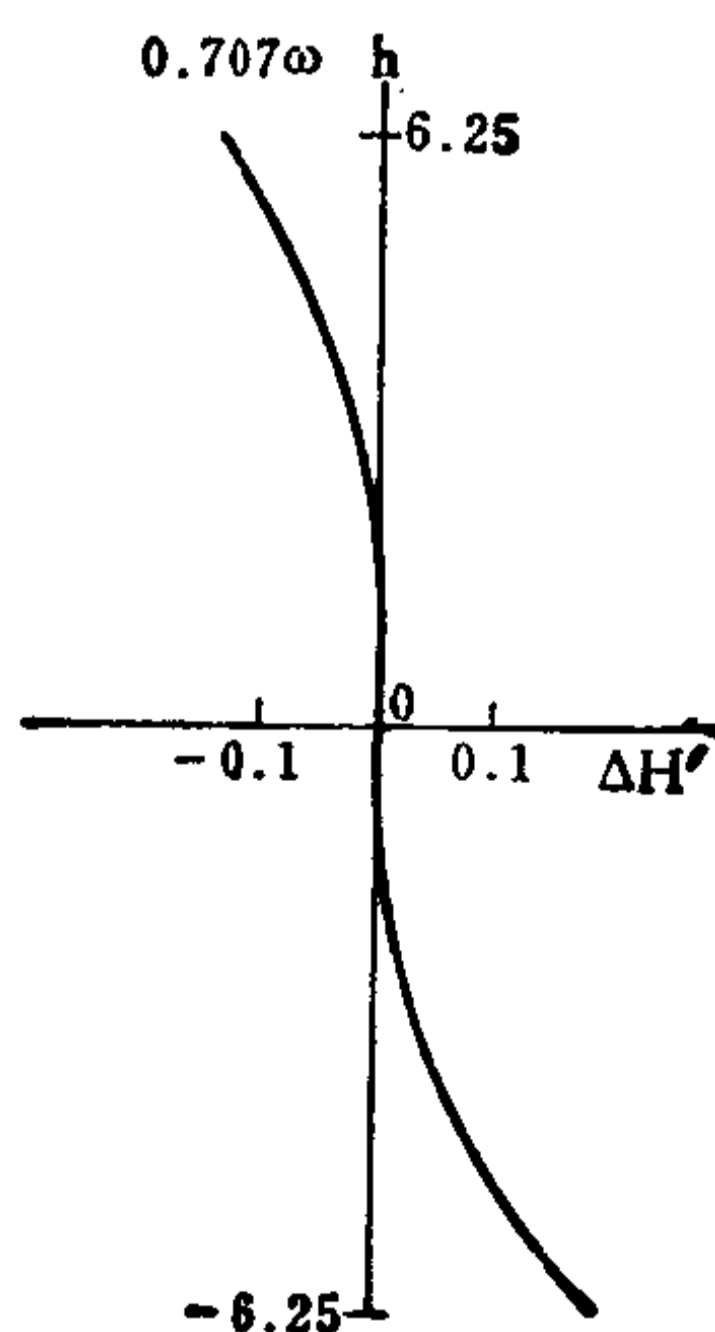
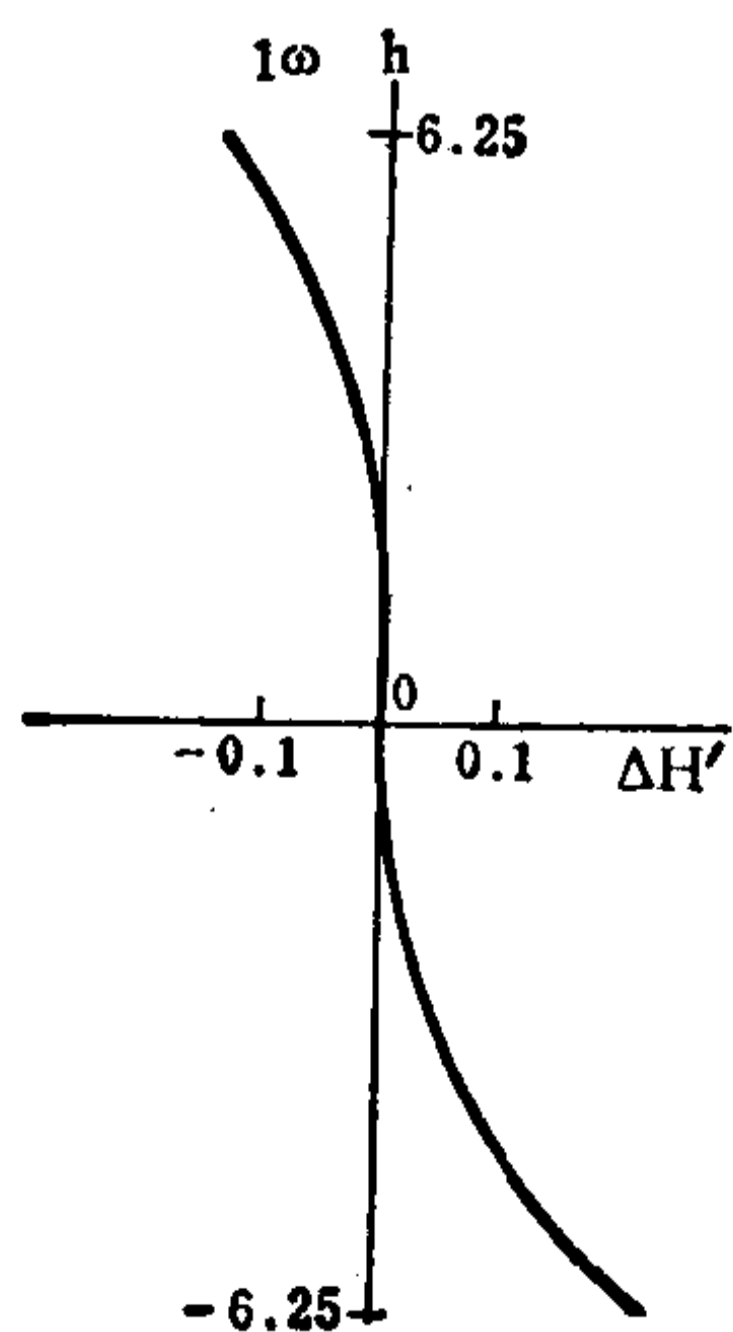
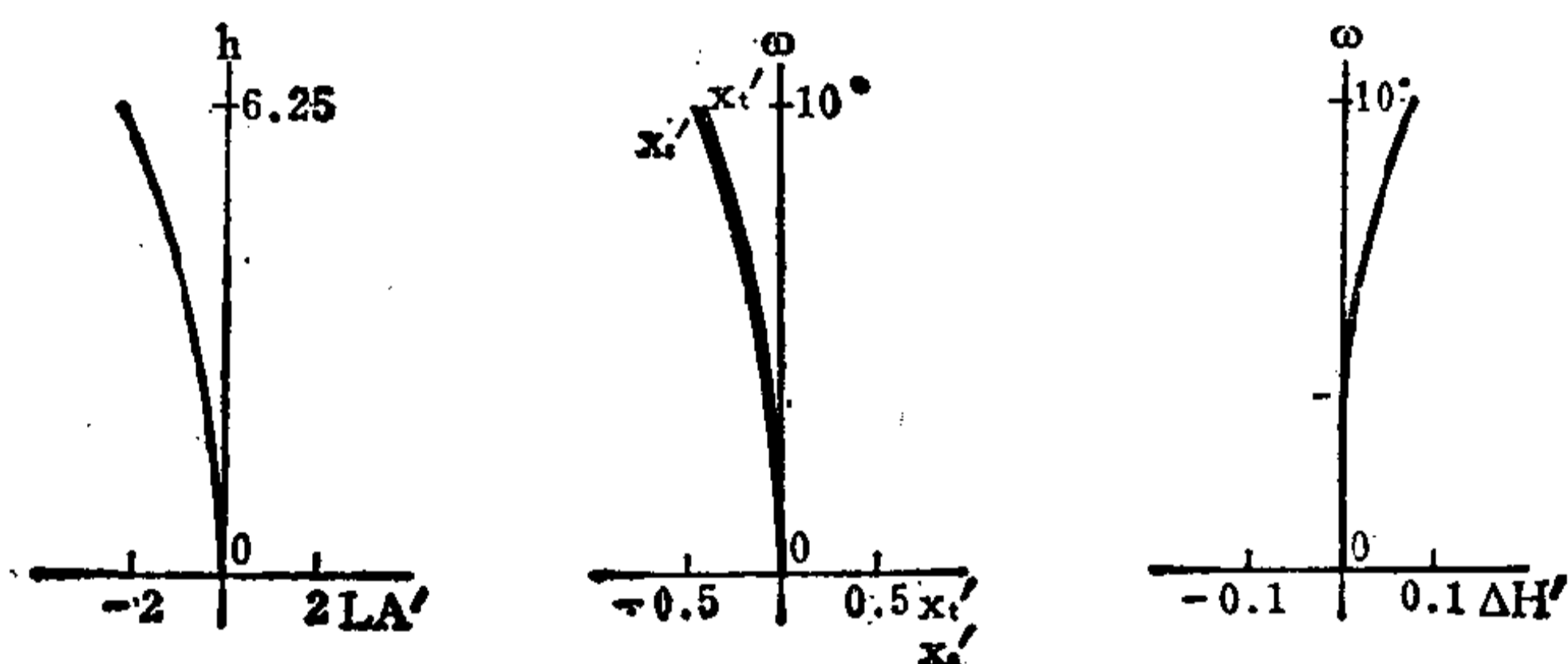

编号: 05-04-027

逆聚焦型透镜系统

E. F. L = 97.4

B. F. L = 132.8

FNo. = 3.9

F. A. = ± 40°

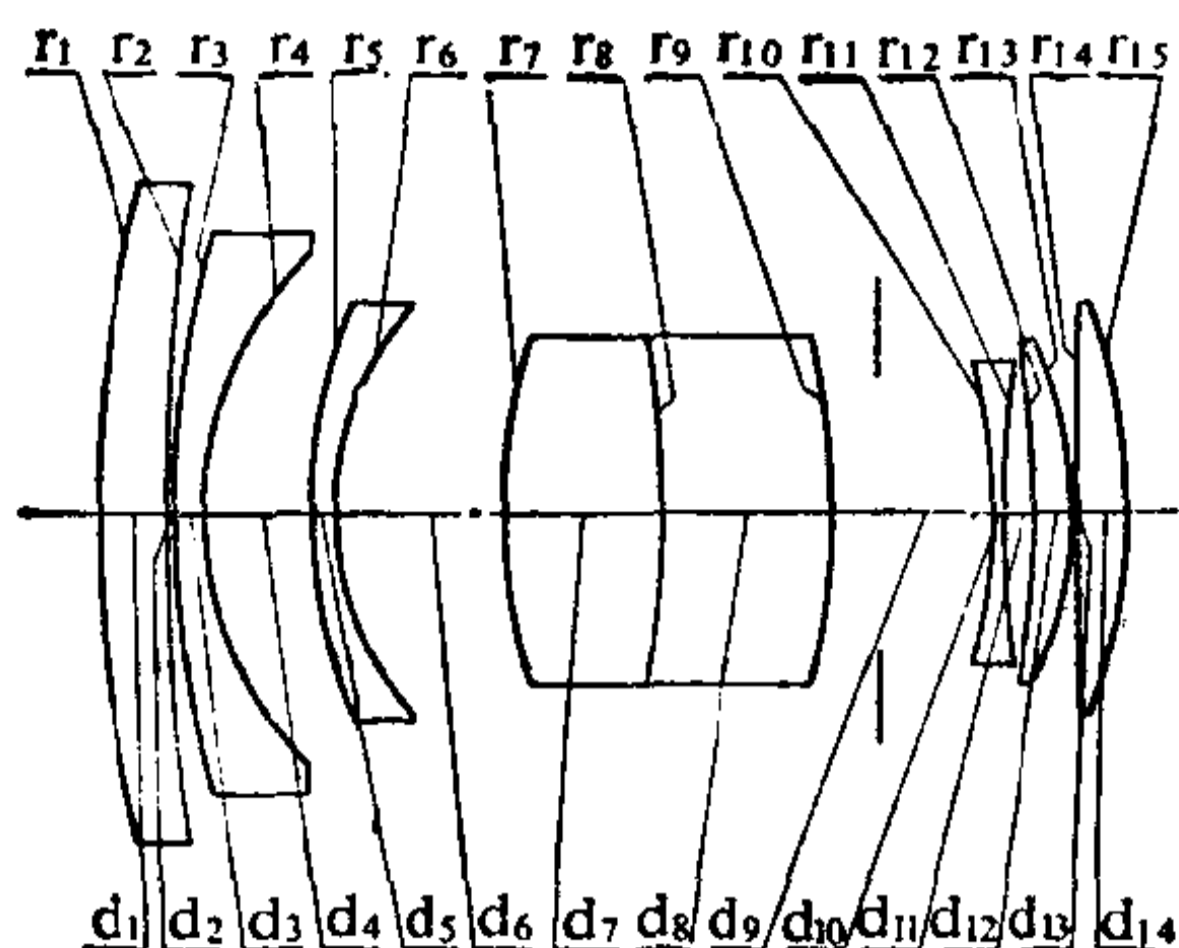

序号	r	d	n	v_d	序号	r	d	n	v_d
1	180.00	9.75	1.65160	58.5	9	-92.60	20.40*		
2	339.30	0.18			10	-75.27	1.80	1.75520	27.5
3	140.97	3.97	1.65160	58.5	11	161.19	3.25		
4	47.83	13.72			12	-124.00	5.78	1.60738	56.7
5	71.30	2.89	1.65160	58.5	13	-52.71	0.18		
6	40.25	21.84			14	6317.00	6.50	1.64250	58.1
7	76.61	19.86	1.67003	47.2	15	-76.79			
8	-144.40	22.38	1.66950	51.5					

20.40* = 6.40 + 14.00

	ΣS_1	ΣS_2	ΣS_3	ΣS_4	ΣS_5	HI	QP(1 ω)
	-0.0369	0.0263	0.0013	-0.1143	-0.5133	81.66	-1.5%
h 或 ω %	LA'	$\Delta H'$	x'_t	x'_s	$x'_t - x'_s$	K_{T1}	$K_{R0.7}$
100	-0.757	-1.275	-4.488	-0.791	-3.697	-0.2868	-0.0711
70	-0.459	-0.802	-1.759	-1.545	-0.214	-0.1680	-0.0218

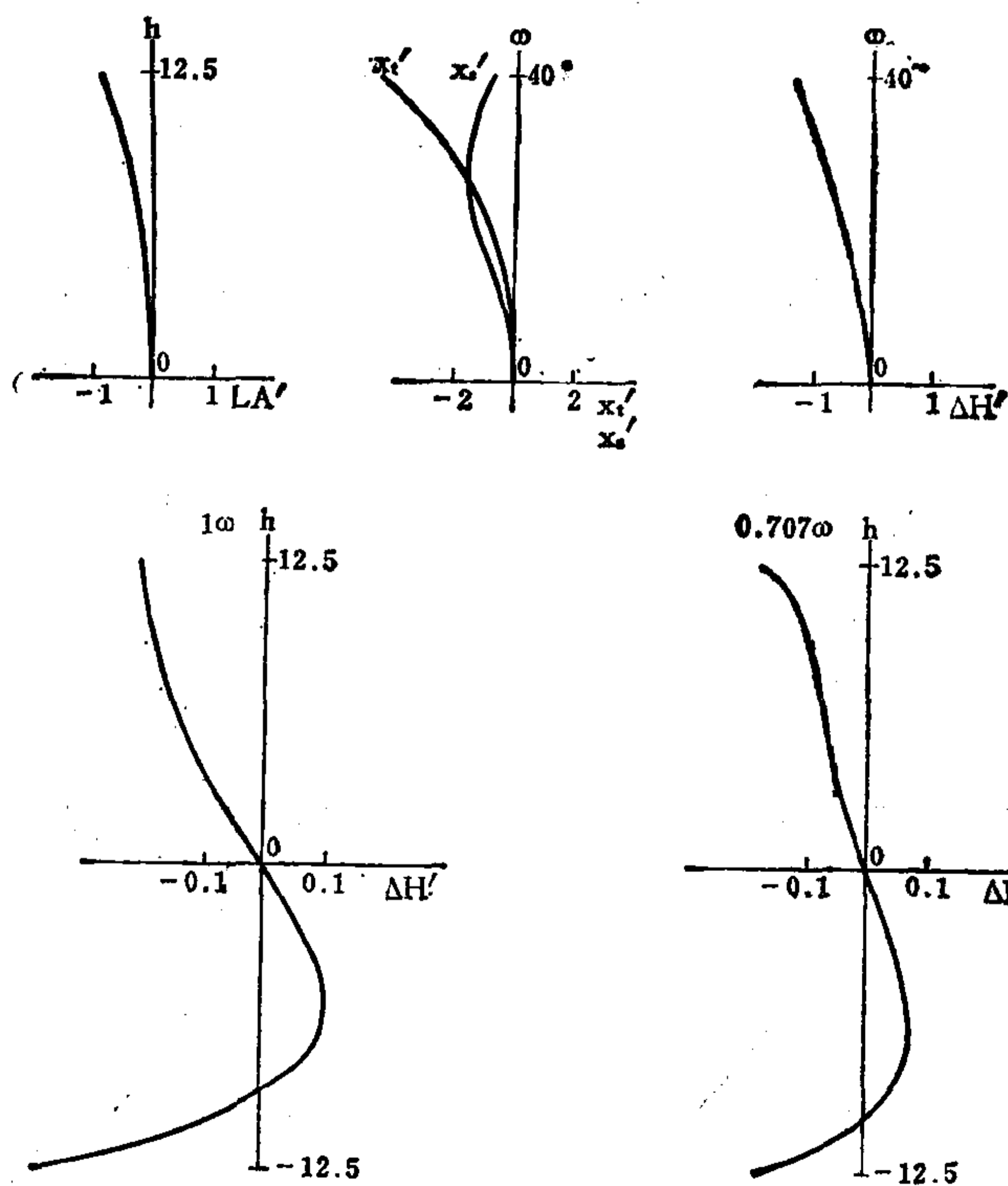

编号: 05-04-028

逆聚焦型透镜系统

E. F. L = 100

B. F. L = 138.8

FN_o = 2.8

F. A. = ± 40°

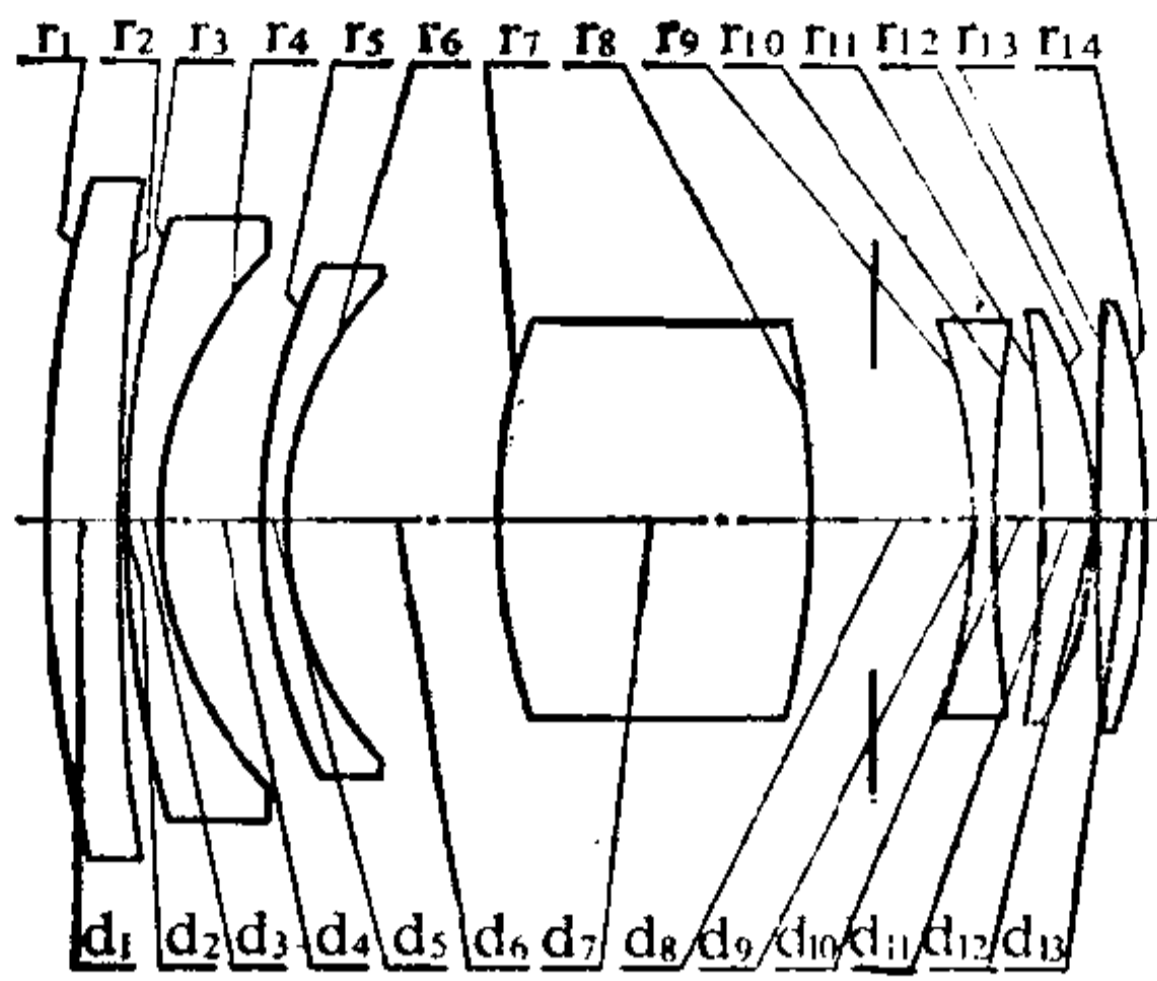

序号	r	d	n	v _d	序号	r	d	n	v _d
1	183.46	9.25	1.64831	33.8	8	-109.25	20.67*		
2	356.30	0.20			9	-73.82	2.95	1.74000	28.2
3	141.73	3.94	1.62041	60.3	10	163.39	5.90		
4	49.02	13.78			11	-183.07	6.50	1.62041	60.3
5	78.54	2.95	1.65830	57.3	12	-57.87	0.20		
6	45.77	26.77			13	13780.00	6.60	1.69680	55.6
7	82.09	40.55	1.66950	51.5	14	-93.17			

20.67* = 8.00 + 12.67

	ΣS ₁	ΣS ₂	ΣS ₃	ΣS ₄	ΣS ₅	HI	QP(1 ω)
	-0.0883	0.0555	-0.0123	-0.1929	-0.8111	83.9	-2.1%
h 或 ω %	LA'	ΔH'	x _t '	x _s '	x _t - x _s	K _{T1}	K _{T0.7}
100	-0.737	-1.789	-3.250	1.030	-4.280	-0.4857	-0.0839
70	-0.418	-0.958	-1.575	-1.174	-0.401	-0.4090	-0.0503

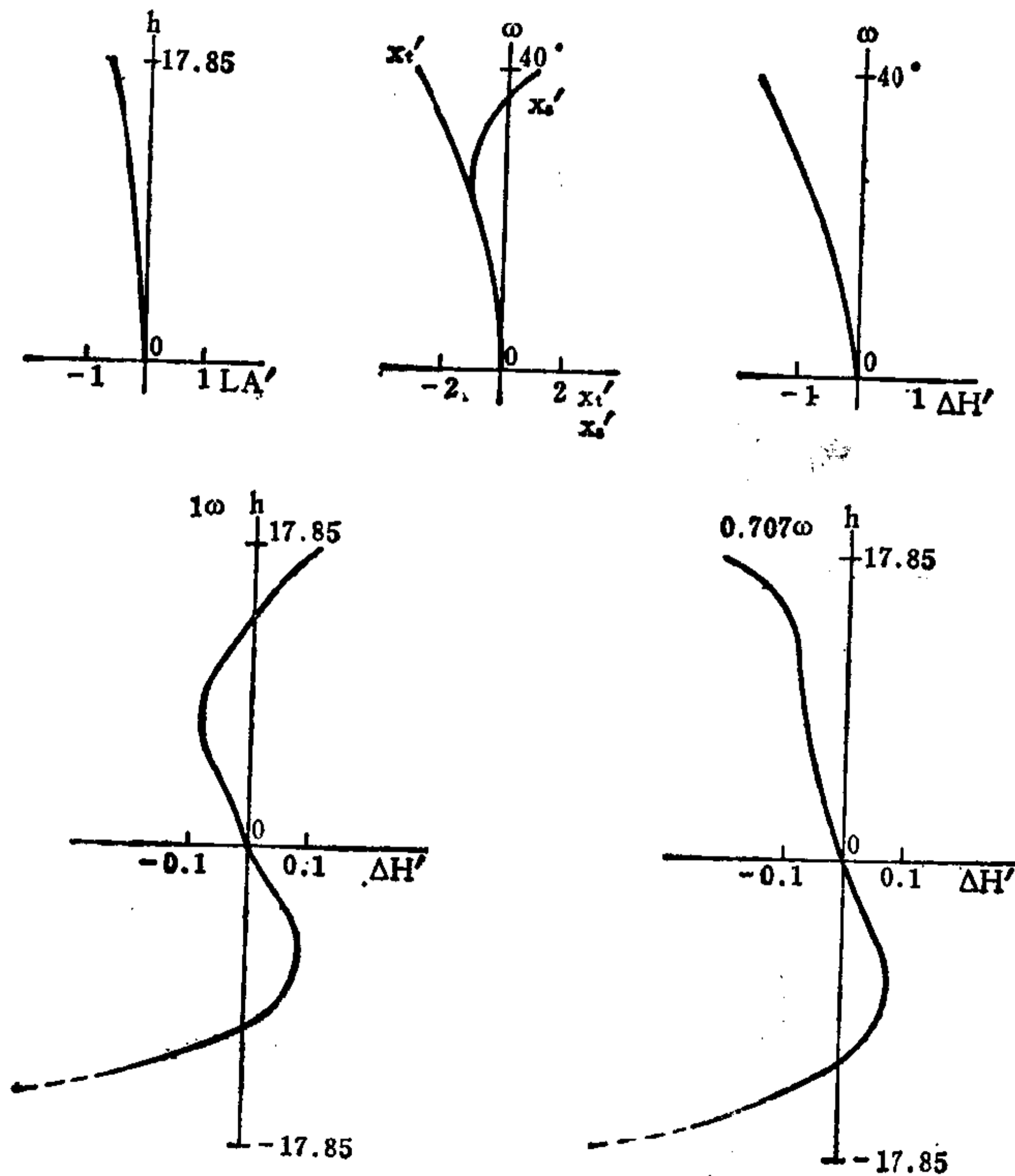

编号: 05-04-029

袖珍四片型摄影物镜

E.F.L=1.0

B.F.L=1.004

FNo. = 8

F.A. = ±25°**

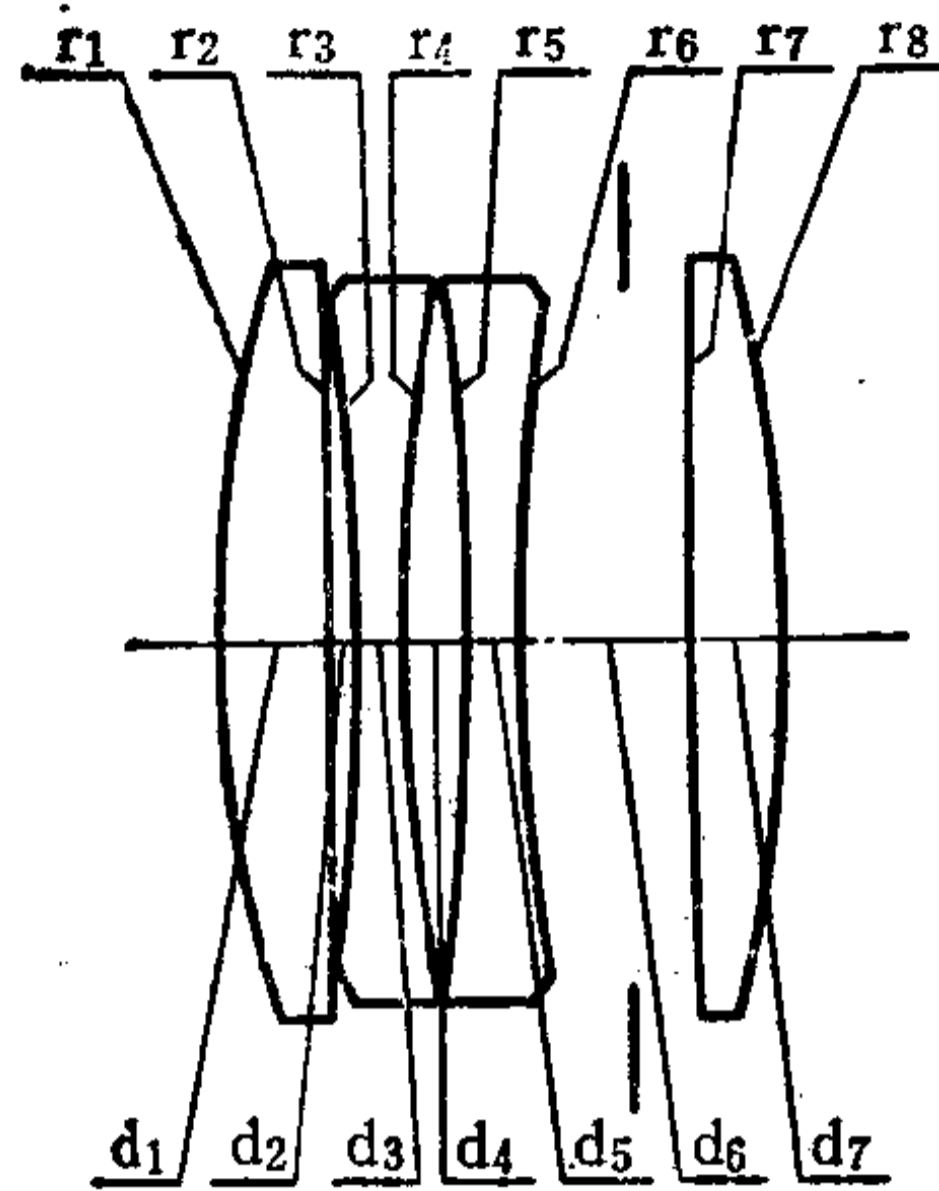

序号	r	d	n _d	v _d	序号	r	d	n _d	v _d
1	0.2263	0.0189	1.682	48.2	5	-0.4715	0.0084	1.617	31.0
2	∞	0.0041			6	0.3485	0.0292*		
3	-0.6748	0.0084	1.501	56.4	7	1.3300	0.0157	1.667	48.4
4	0.3409	0.0112			8	-0.2732			

0.0292* = 0.0192 + 0.0100

	ΣS ₁	ΣS ₂	ΣS ₃	ΣS ₄	ΣS ₅	HI	QP(1 ω)
	0.000012	-0.000006	-0.000002	-0.000125	-0.000867	0.47	-2.3%
h 或 ω %	LA'	ΔH'	x _t	x _s	x _t - x _s	K' _{T1}	K' _{T0.7}
100	0.00883	-0.0107	0.01955	0.00381	0.01574	0.000739	0.000273
70	0.00240	-0.0032	0.00001	-0.00389	0.00390	0.000154	0.000072

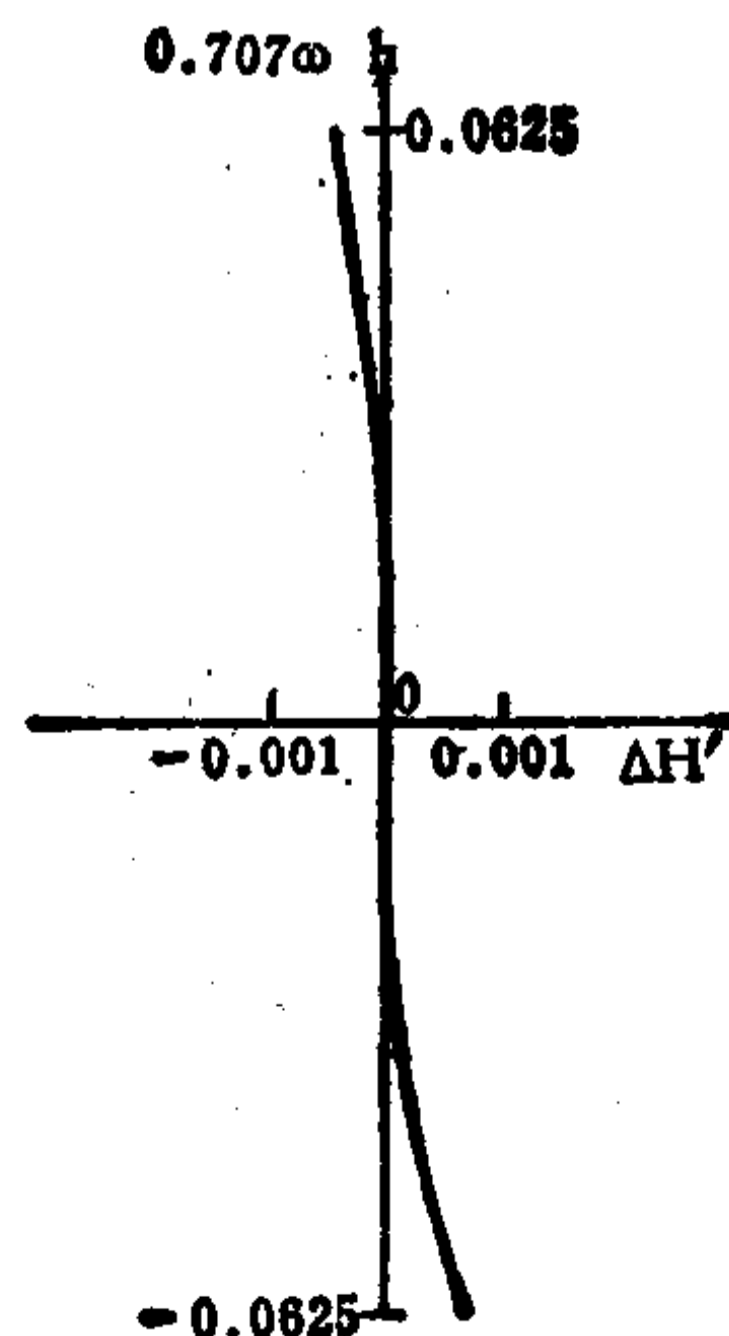
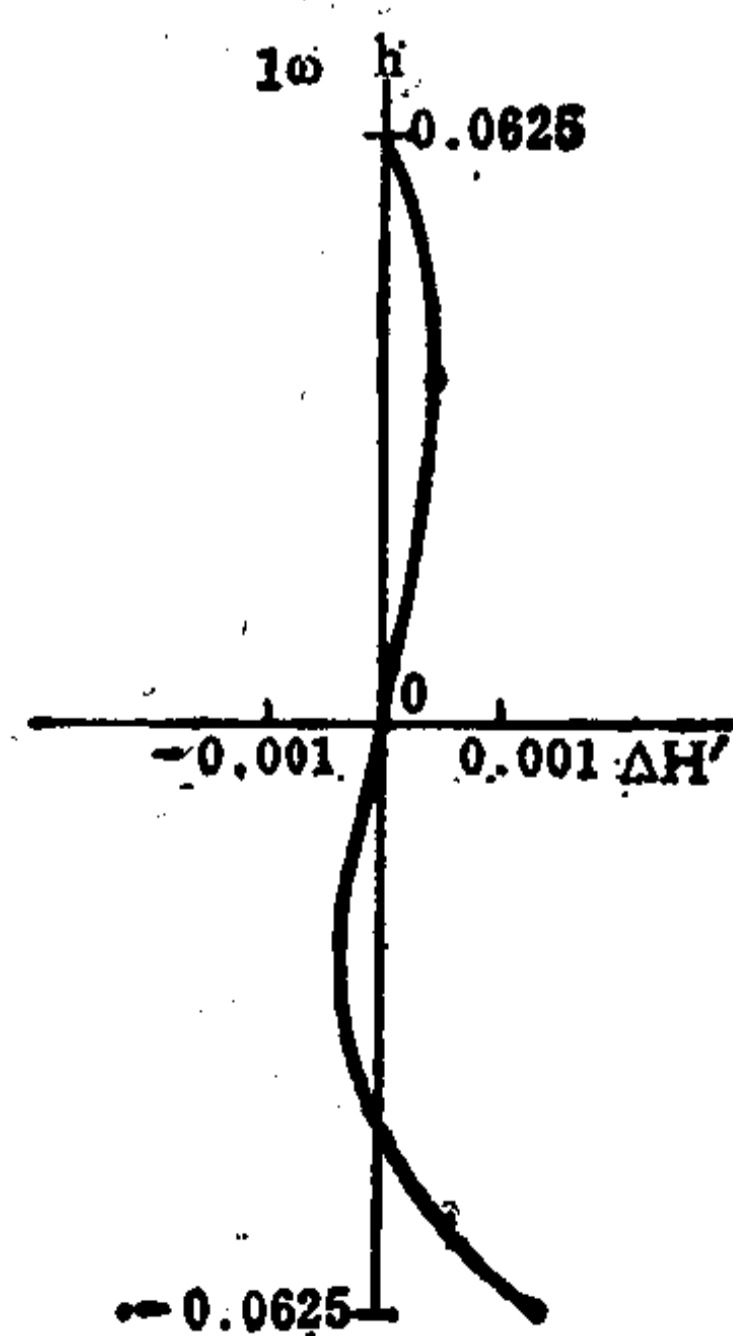
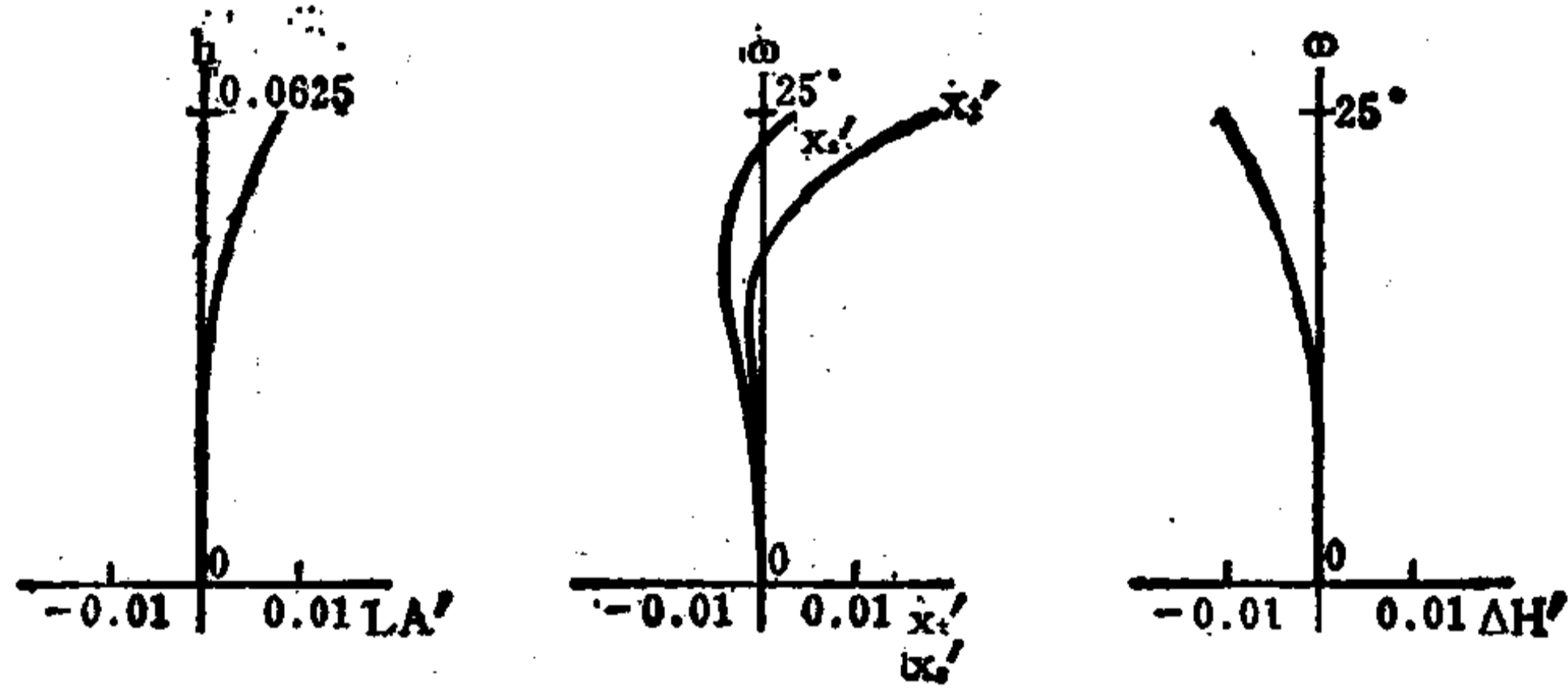

编号: 05-04-030

袖珍四片型摄影物镜

E. F. L = 0.998

B. F. L = 0.998

FNo. = 8

F. A. = $\pm 25^{\circ}$ **

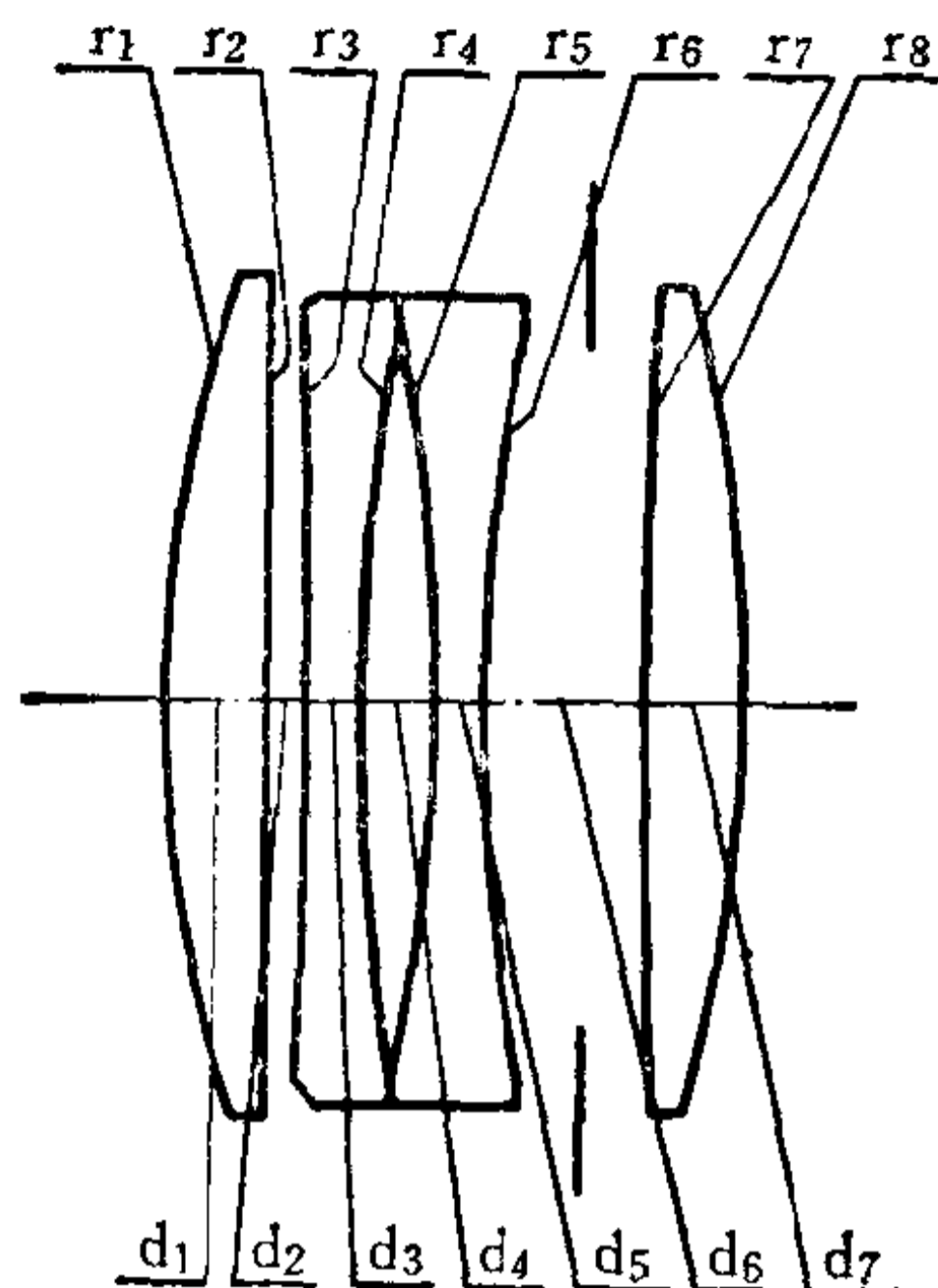

序号	r	d	n _d	v _d	序号	r	d	n _d	v _d
1	0.2252	0.0190	1.623	56.9	5	-0.3401	0.0084	1.584	37.0
2	∞	0.0064			6	0.3262	0.0292*		
3	-1.4350	0.0084	1.552	63.5	7	1.3324	0.0168	1.713	53.8
4	0.4143	0.0129			8	-0.2786			

0.0292* = 0.0192 + 0.0100

	ΣS_1	ΣS_2	ΣS_3	ΣS_4	ΣS_5	HI	QP(1 ω)
	0.000039	-0.000027	-0.000010	-0.000133	-0.000820	0.465	-2.2%
h 或 ω %	LA'	$\Delta H'$	x'_t	x'_s	$x'_t - x'_s$	K'_{T1}	$K'_{T0.7}$
100	0.0135	-0.0100	0.00529	0.00096	0.00433	0.000119	-0.000007
70	0.0044	-0.0030	-0.00410	-0.00510	0.00100	-0.000278	-0.000129

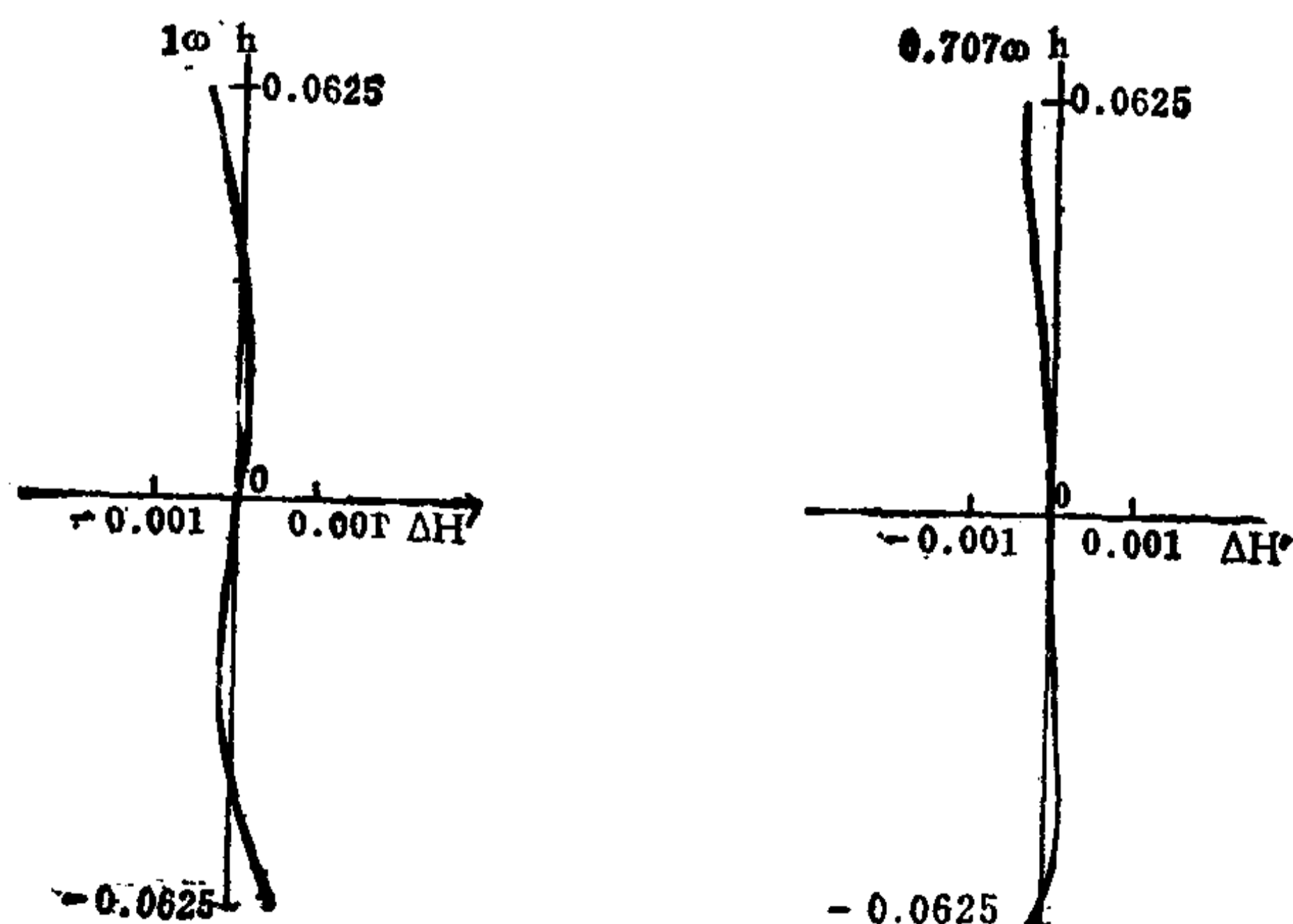
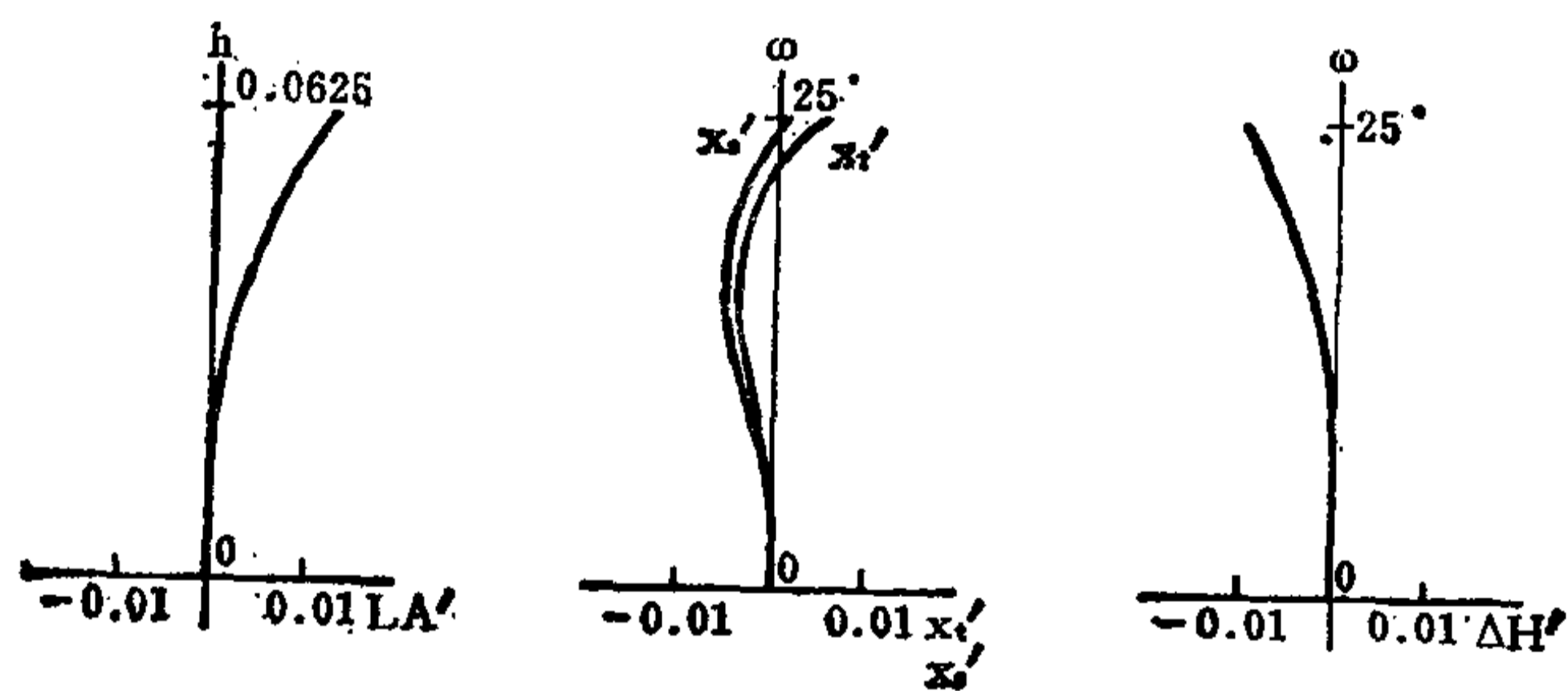

编号: 05-04-031

远 距 离 照 相 镜 头

E. F. L = 100.02

B. F. L = 37.41

FNo. = 3.5

F. A. = ± 9°

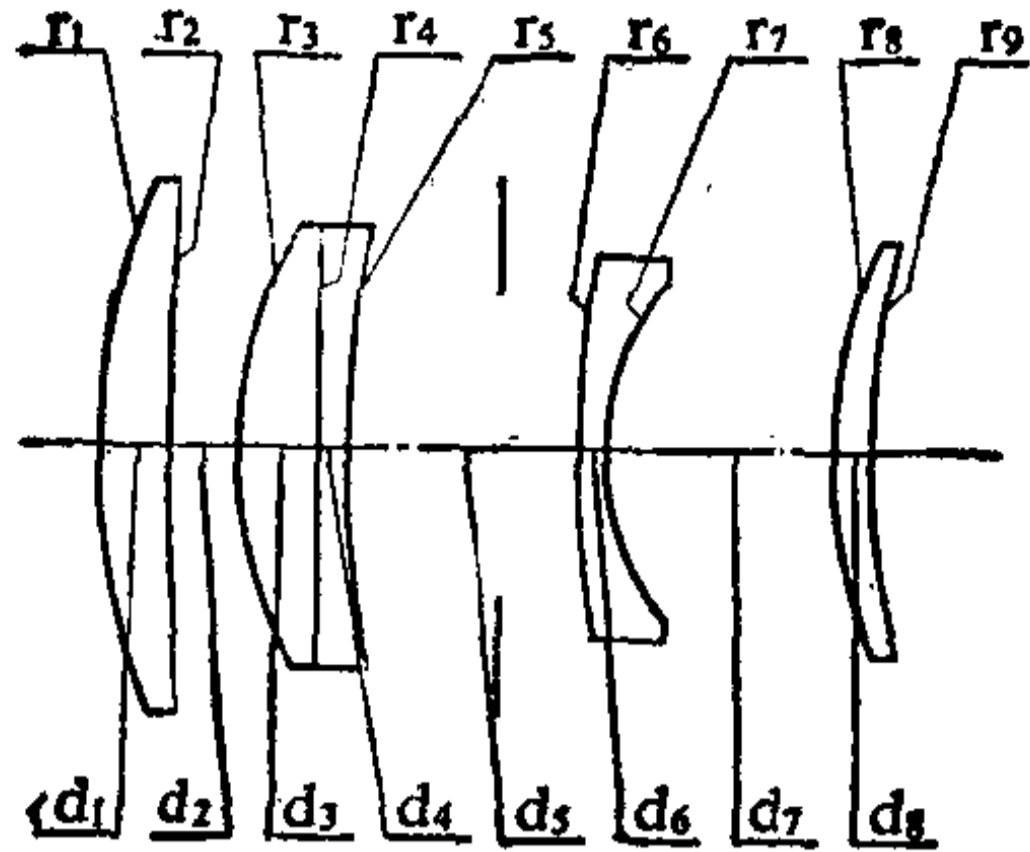

序号	r	d	n	v	序号	r	d	n	v
1	45.297	4.40	1.62041	60.2	6	79.258	1.79	1.66998	39.3
2	355.454	4.43			7	17.670	14.7		
3	29.103	5.19	1.48749	69.8	8	33.946	2.52	1.80518	25.4
4	∞	1.77	1.76182	26.5	9	62.394			
5	74.890	14.91*							

14.91* = 10.00 + 4.91

	ΣS_1	ΣS_2	ΣS_3	ΣS_4	ΣS_5	HI	QP(100)
	-0.00703	-0.00434	0.00038	-0.00604	0.07379	15.83	1.2%
h 或 ω %	LA'	$\Delta H'$	x'_t	x'_s	$x'_t - x'_s$	K'_{T1}	$K'_{T0.7}$
100	-0.0043	0.1939	-0.0881	0.0055	-0.0936	0.05095	0.02781
70	-0.0472	0.0829	-0.0320	-0.0365	0.0045	-0.00934	-0.00160

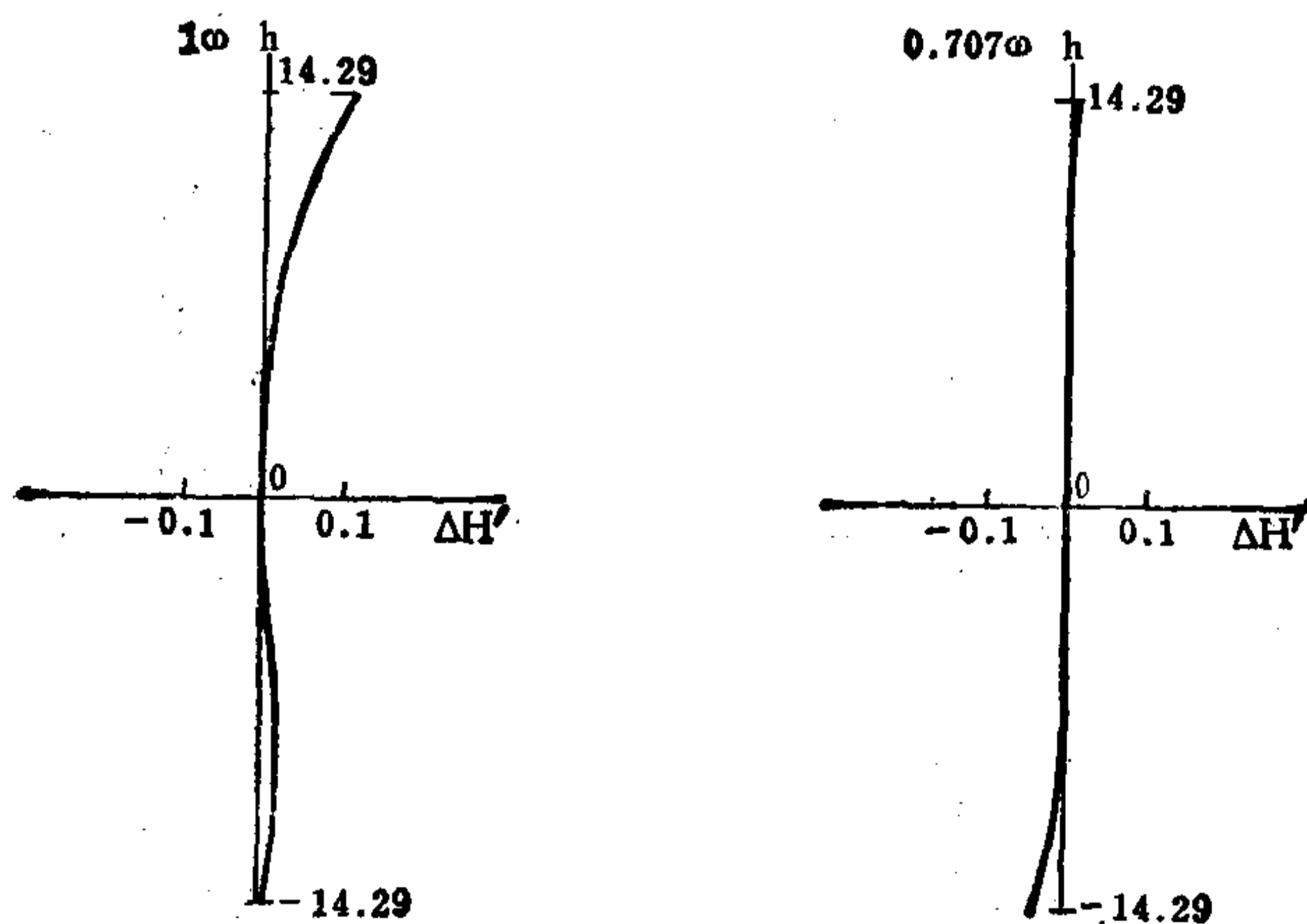
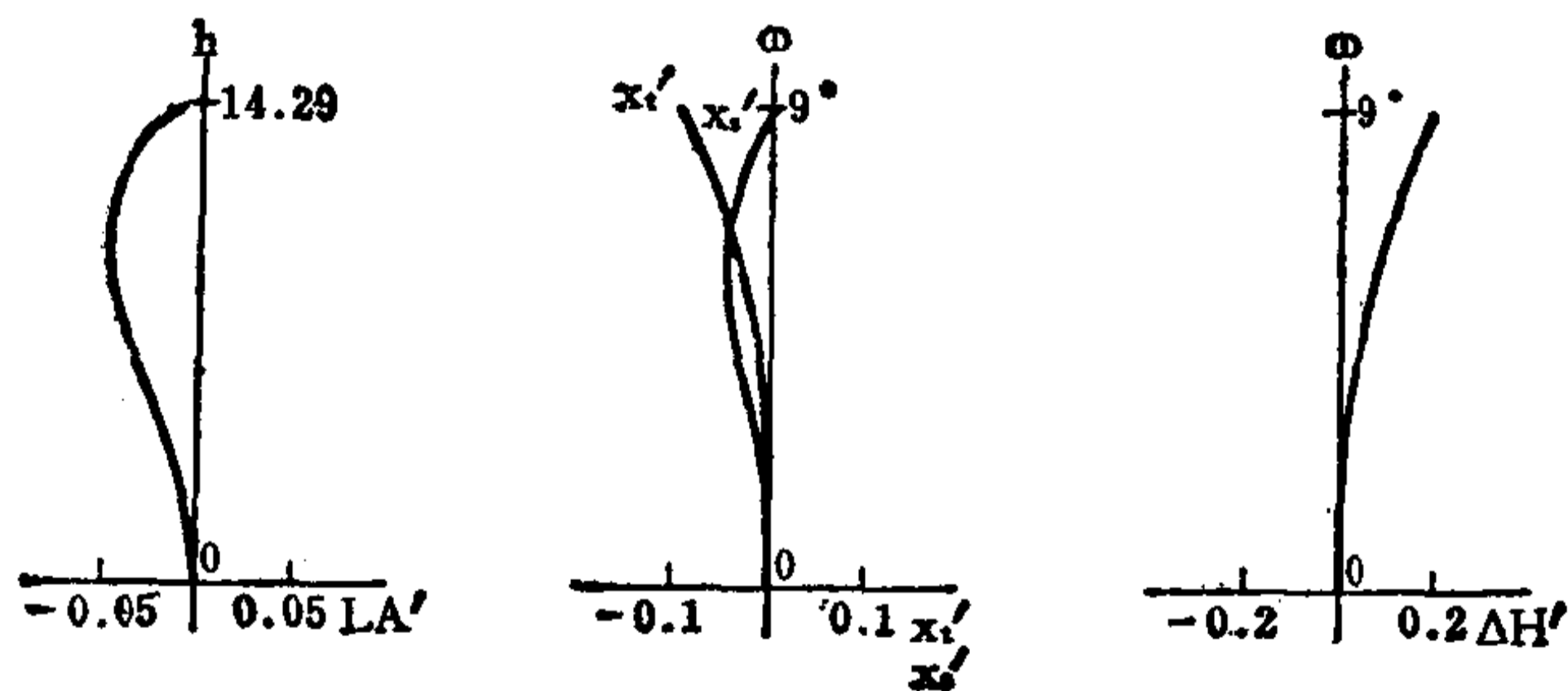

编号: 05-04-032

小倍率超远距照相镜头

E. F. L = 100

B. F. L = 22.37

FNo. = 6

F. A. = ± 2°

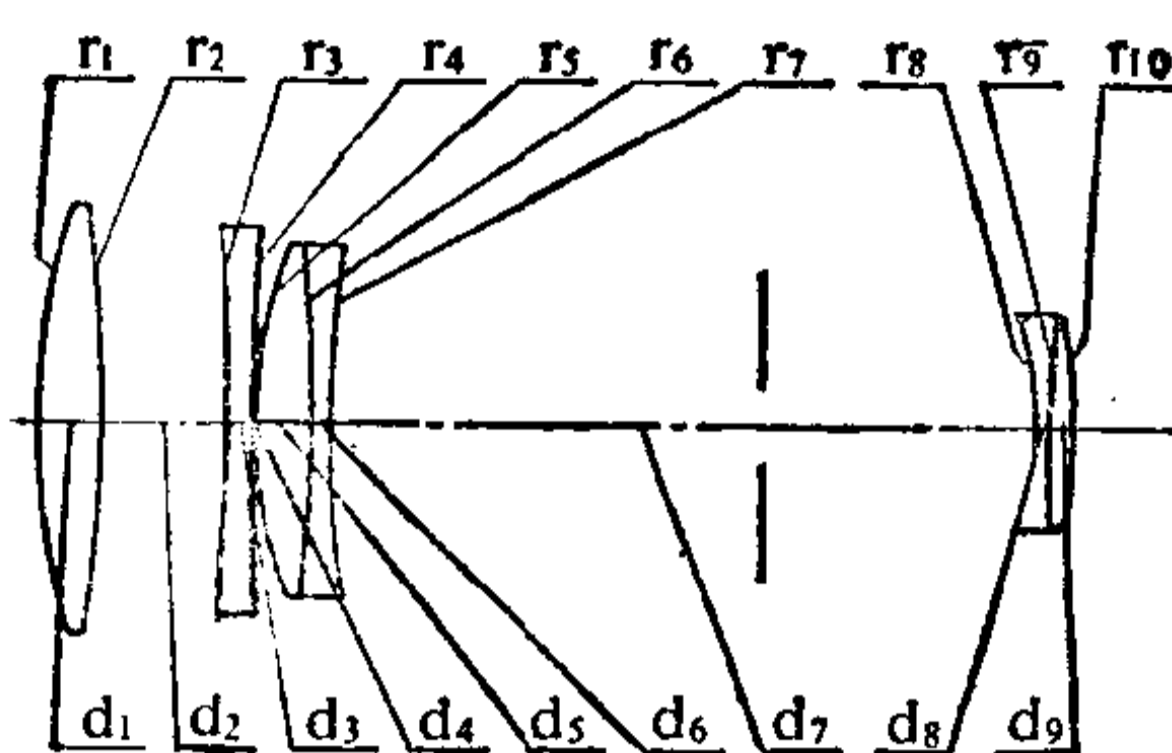

序号	r	d	n	v	序号	r	d	n	v
1	30.684	2.504	1.48749	70.1	6	-54.291	0.835	1.61340	43.8
2	-86.122	5.587			7	61.567	33.643*		
3	-76.806	1.002	1.80452	39.6	8	-12.274	0.584	1.71300	54.0
4	189.665	0.200			9	42.912	1.002	1.69895	30.1
5	23.362	2.337	1.48749	70.1	10	-24.038			

33.643* = 20.000 + 13.643

	ΣS_1	ΣS_2	ΣS_3	ΣS_4	ΣS_5	HI	QP(1 ω)
	-0.00143	0.00013	-0.00014	0.00031	0.00173	3.5	0.3%
h 或 ω %	LA'	$\Delta H'$	x_t'	x_s'	$x_t' - x_s'$	K_{T1}'	$K_{T0.7}'$
100	0.0083	0.0104	-0.0110	0.0116	-0.0226	-0.000746	0.000585
70	-0.0252	0.0037	-0.0047	0.0060	-0.0107	-0.001187	0.000197

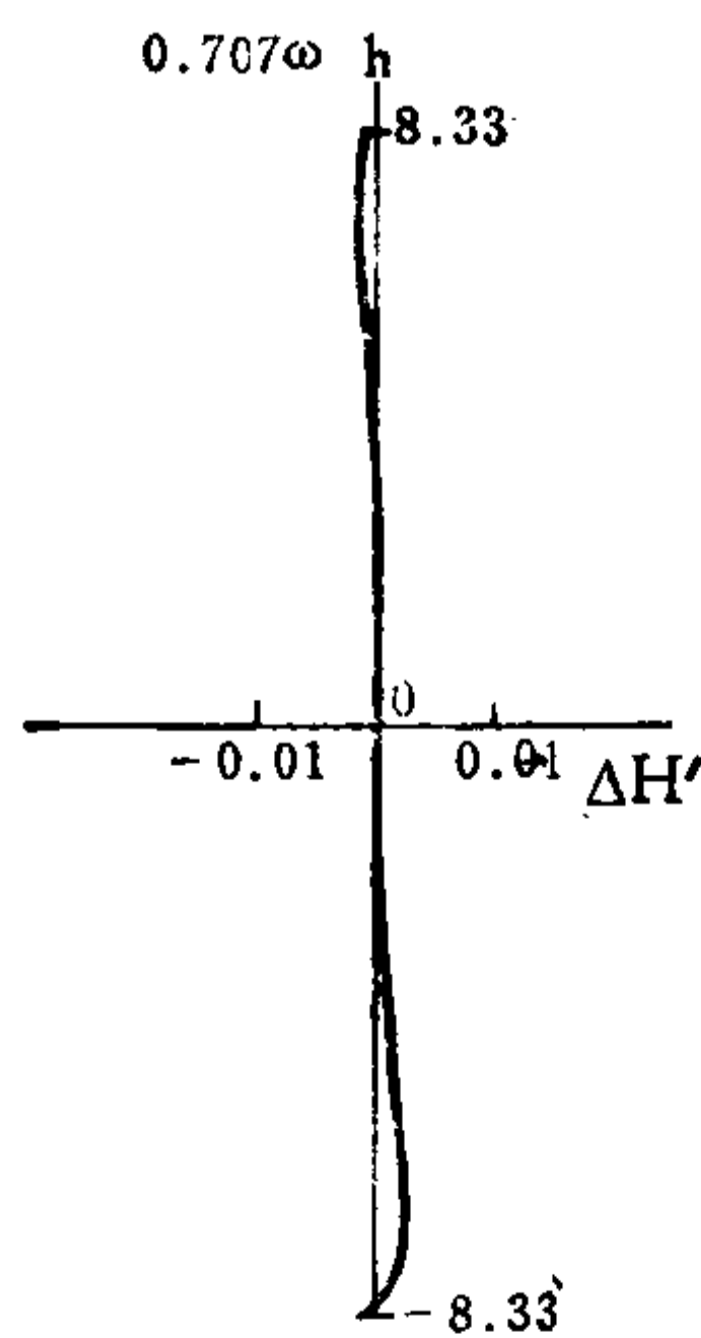
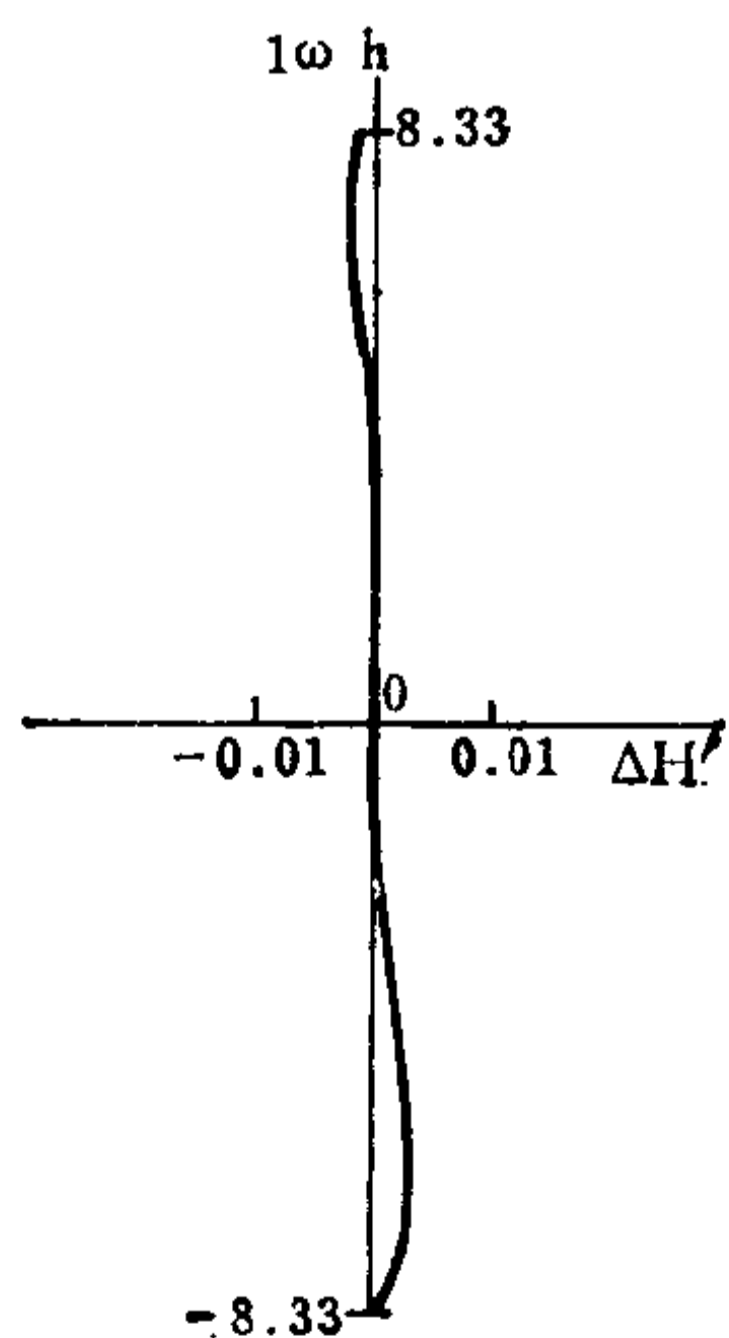
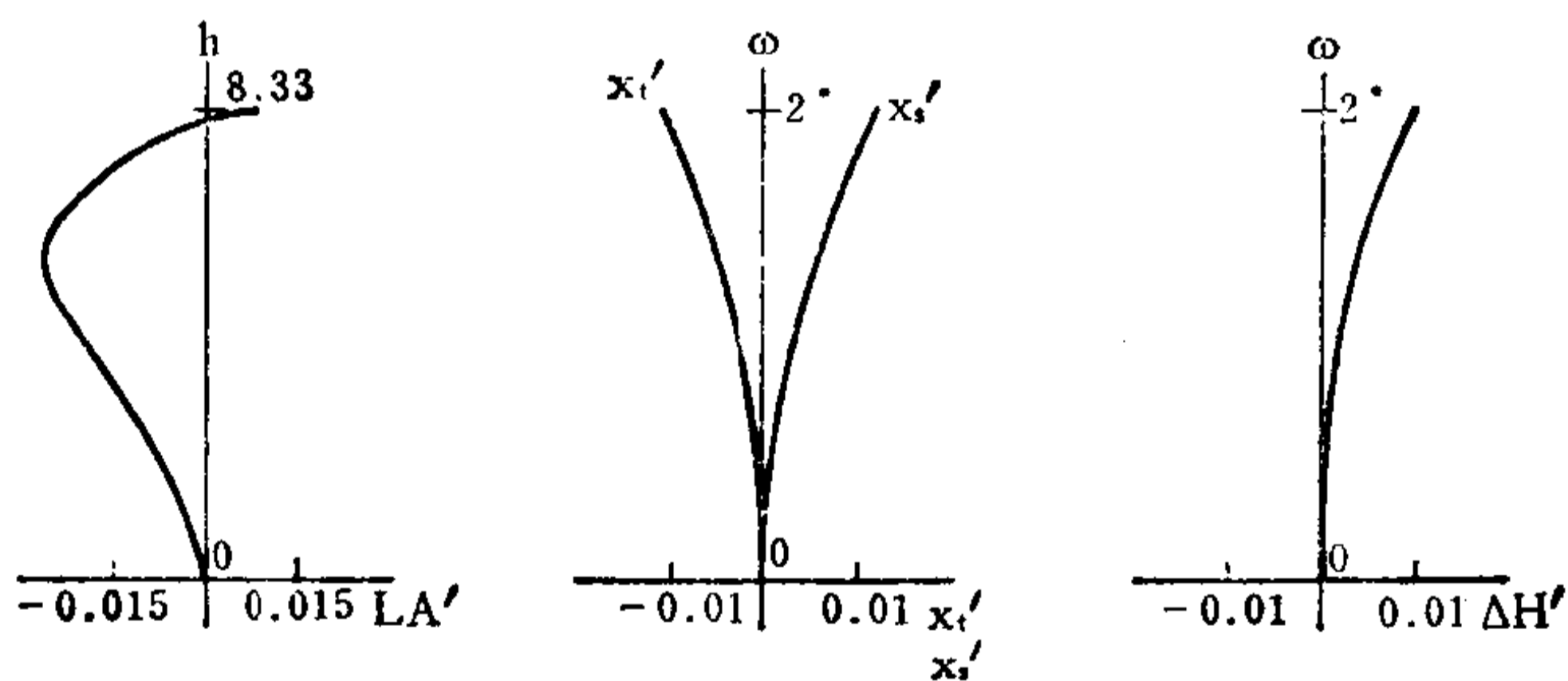

编号: 05-04-033

塑料及玻璃的袖珍四片型物镜

E. F. L = 0.967

B. F. L = 0.976

FNo. = 7.7

F. A. = ± 20°**

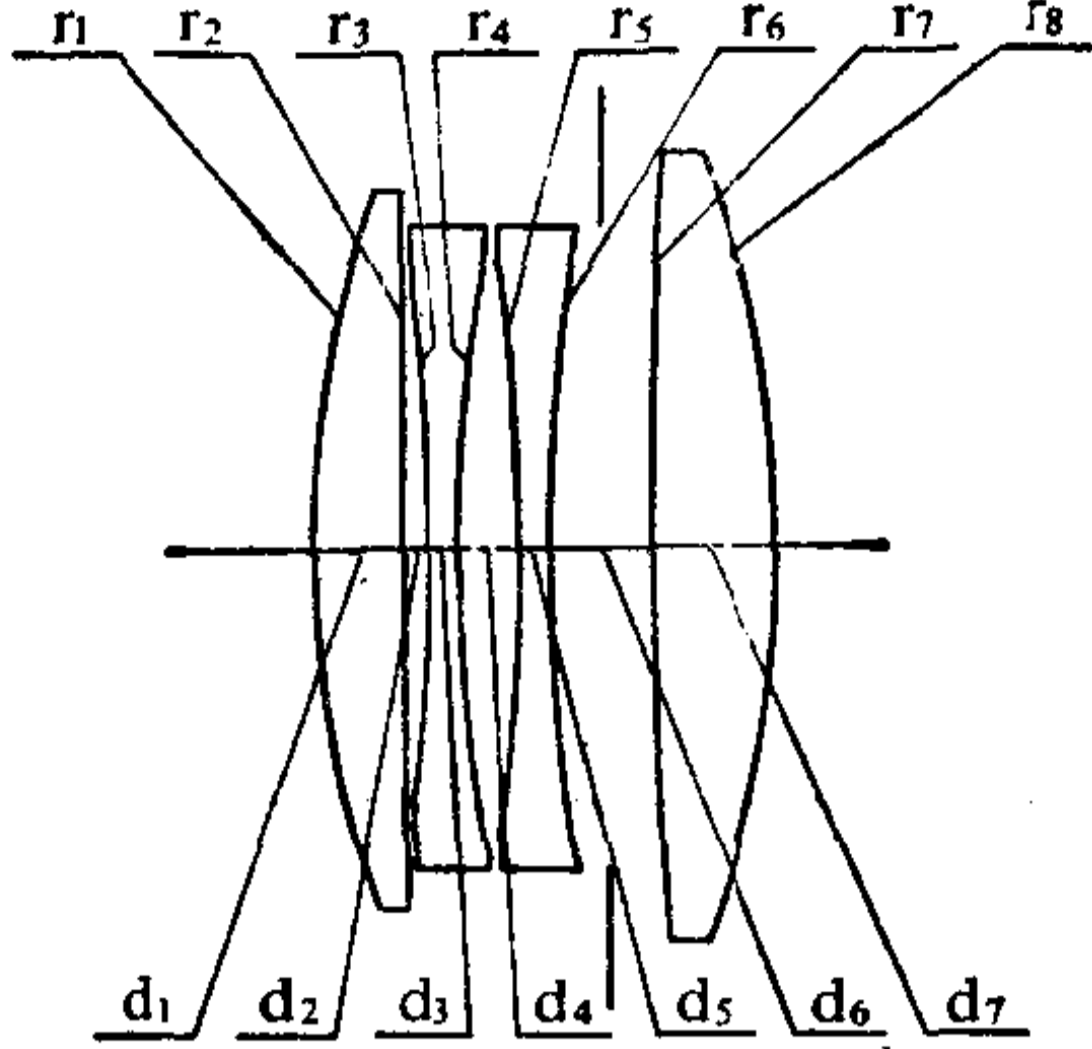

序号	r	d	nd	v	序号	r	d	nd	v
1	0.233	0.0204	1.678	55.2	5	-0.466	0.0063	1.592	30
2	∞	0.0044			6	0.392	0.0214*		
3	-0.479	0.0063	1.492	57.2	7	1.109	0.0261	1.643	48.0
4	0.326	0.0125			8	-0.253			

0.0214* = 0.0114 + 0.0100

	ΣS ₁	ΣS ₂	ΣS ₃	ΣS ₄	ΣS ₅	HI	QP(1ω)
	-0.000009	-0.000018	0.000011	-0.000087	-0.000493	0.35	-1.37%
h 或 ω%	LA'	ΔH'	x _t '	x _s '	x _t ' - x _s '	K _{T1}	K' _{T0.7}
100	0.00612	-0.00486	0.01129	-0.00136	0.01265	-0.000457	-0.000309
70	0.00104	-0.00156	0.00093	-0.00281	0.00374	-0.000247	-0.000158

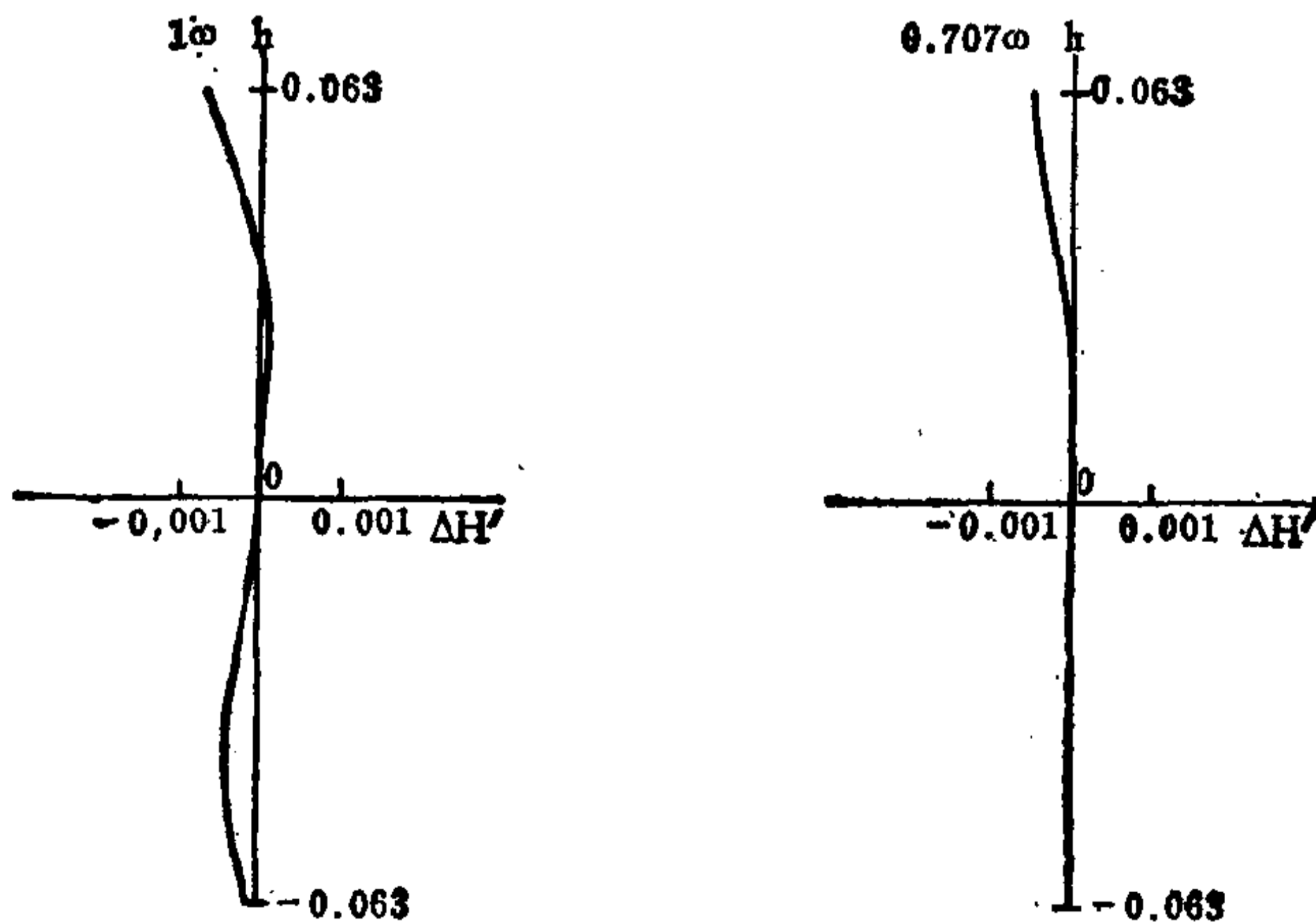
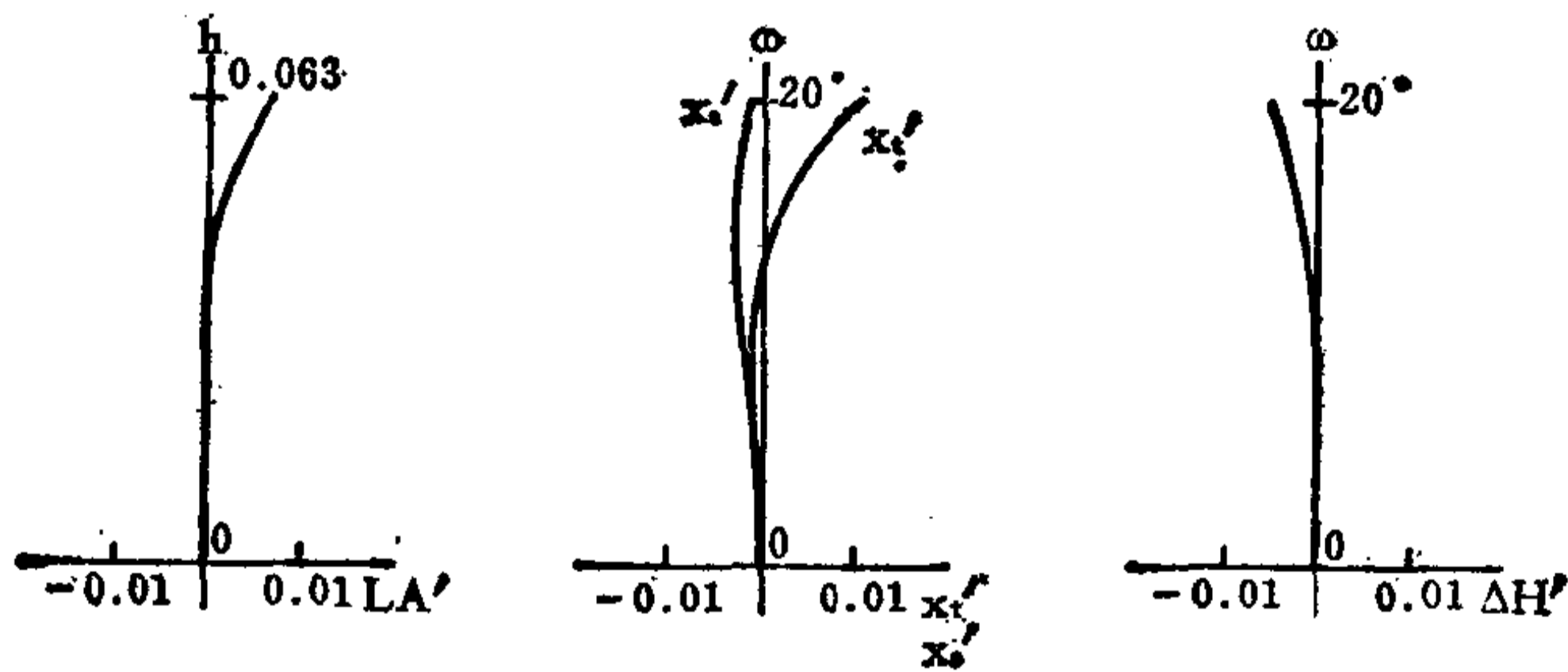

编号: 05-04-034

塑料及玻璃的袖珍四片型物镜

E. F. L = 1.037

B. F. L = 1

FNo. = 8.2

F. A. = $\pm 20^{\circ}$ **

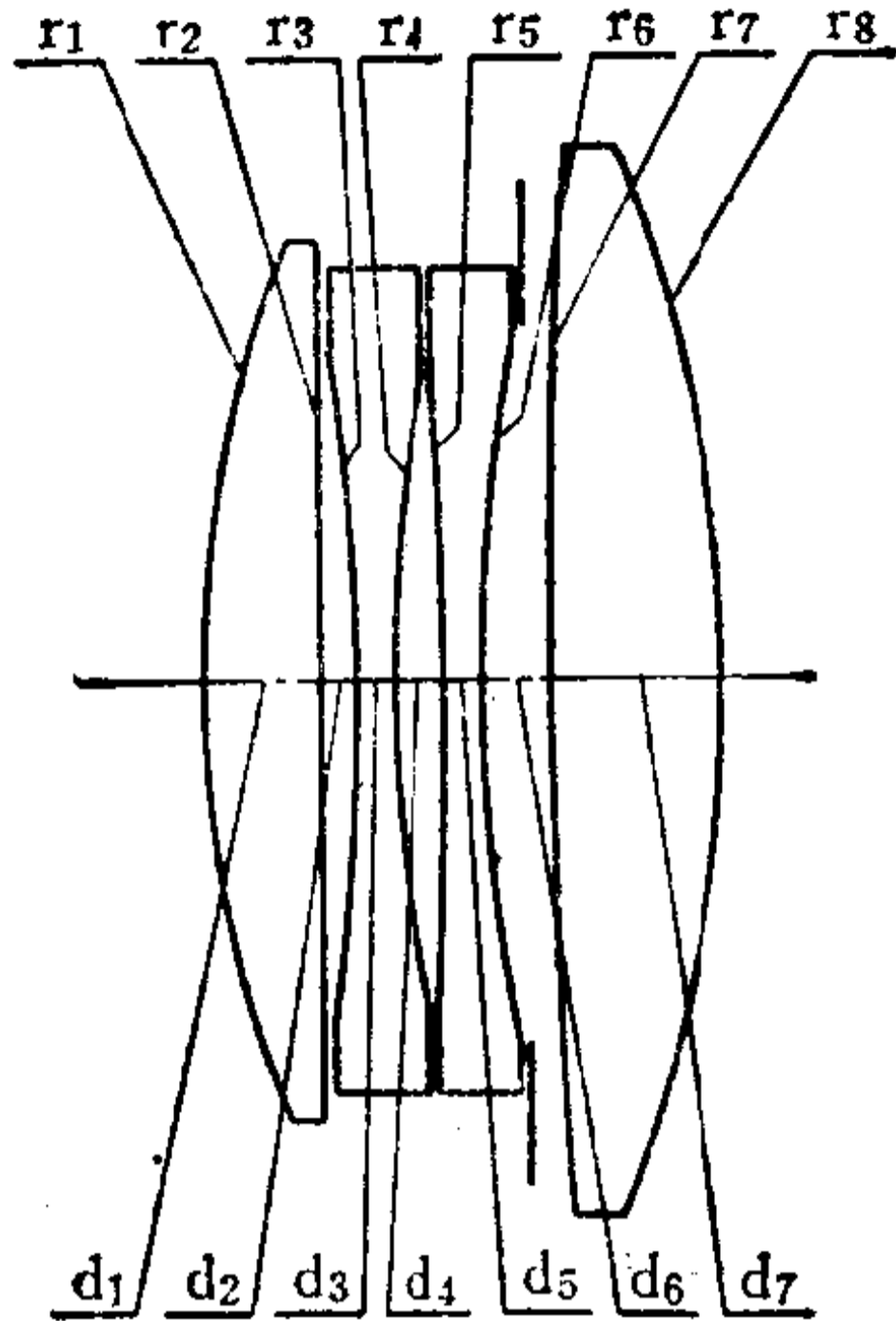

序号	r	d	n _d	v	序号	r	d	n _d	v
1	0.213	0.0207	1.678	55.2	5	-0.701	0.0072	1.592	30.8
2	∞	0.0056			6	0.352	0.0113*		
3	-0.500	0.0072	1.492	57.2	7	1.179	0.0311	1.615	51.2
4	0.277	0.0093			8	-0.270			

$$0.0113^* = 0.0060 + 0.0053$$

	ΣS_1	ΣS_2	ΣS_3	ΣS_4	ΣS_5	HI	QP(1 ω)
	0.000089	-0.0000002	-0.0000003	-0.0000903	-0.0001243	0.379	-0.38%
h 或 ω %	LA'	$\Delta H'$	x'_t	x'_s	$x'_t - x'_s$	K'_{r1}	$K'_{r0.7}$
100	0.02402	-0.00143	0.00900	-0.00473	0.01373	-0.000654	-0.000084
70	0.00871	-0.00044	-0.00137	-0.00451	0.00314	-0.000448	-0.000077

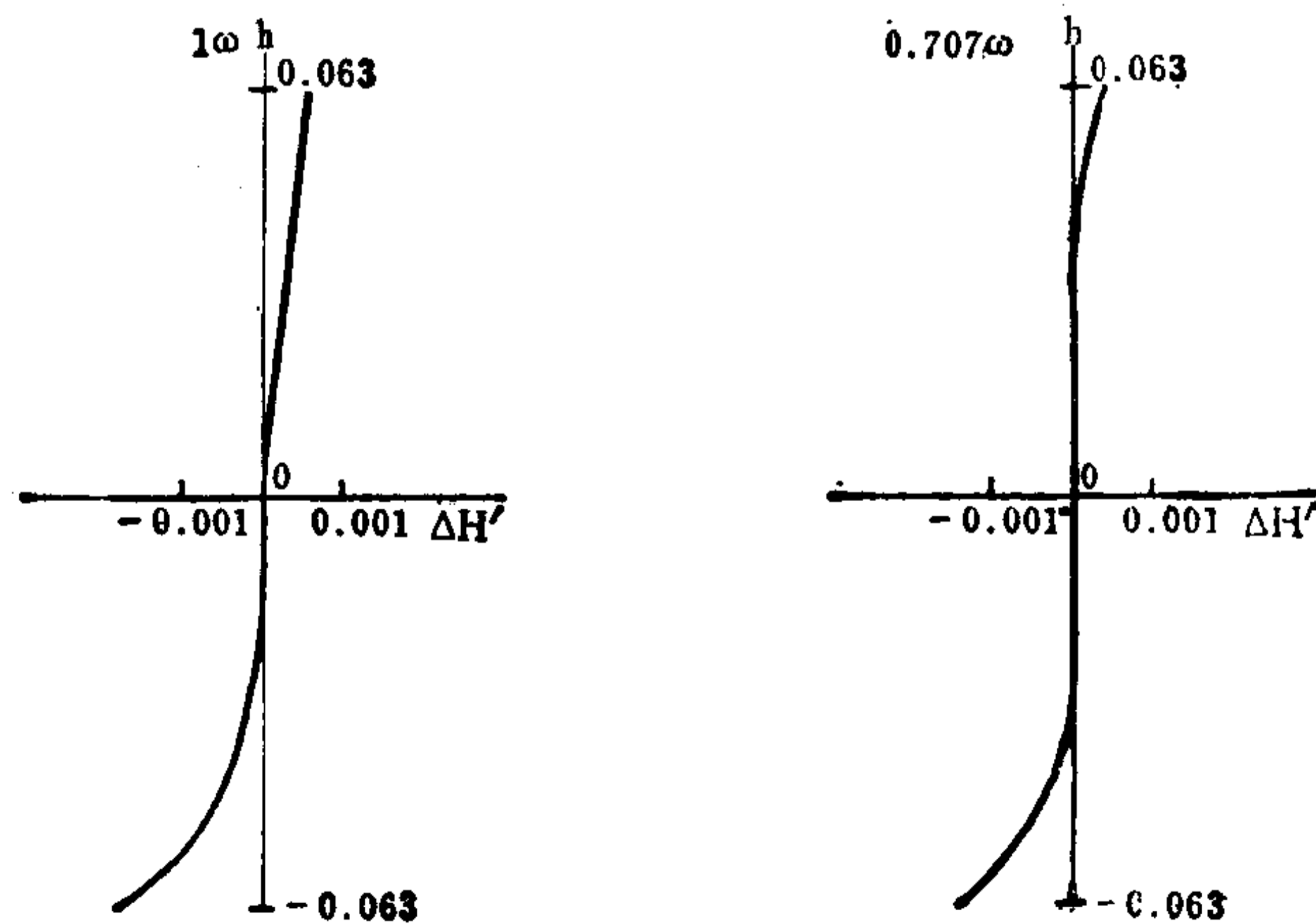
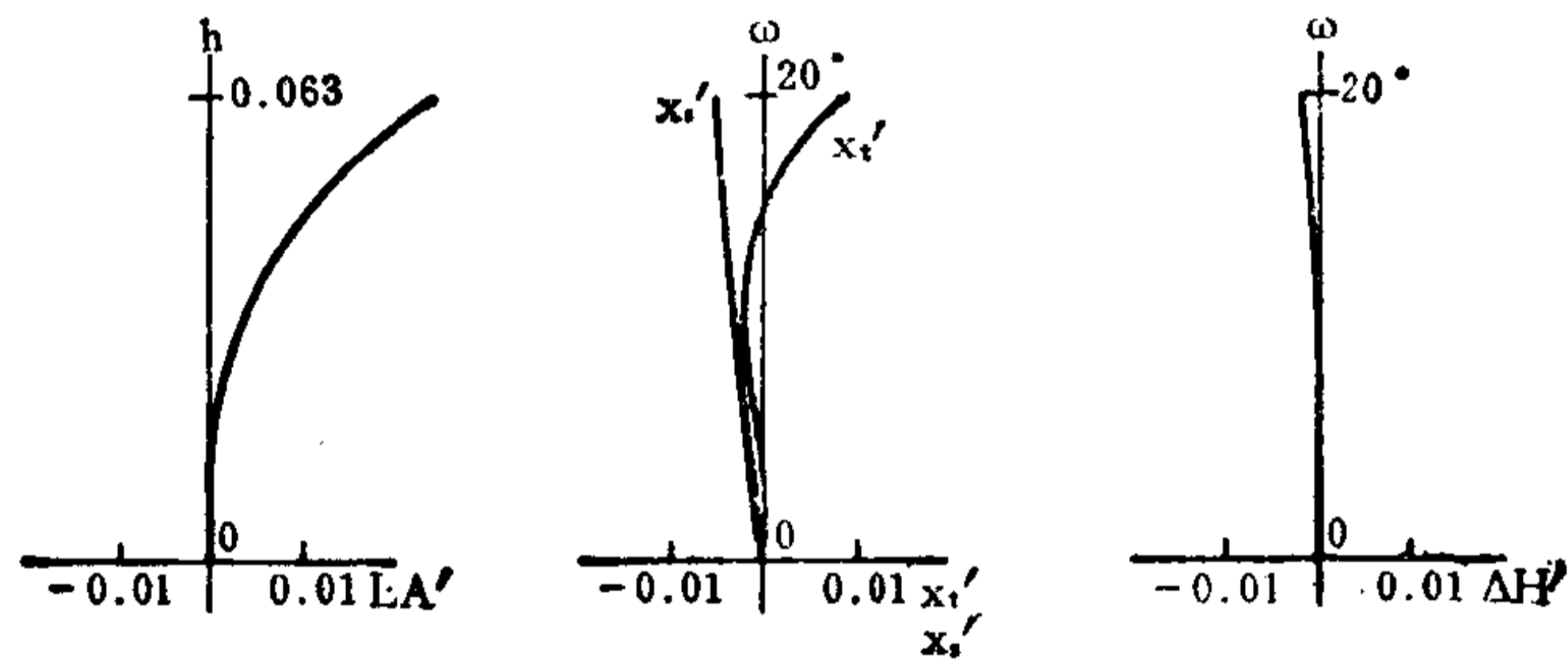

编号: 05-04-035

精密透镜系统

E. F. L = 183.8

B. F. L = 51.32

FNo. = 4

F. A. = $\pm 15^\circ$ **

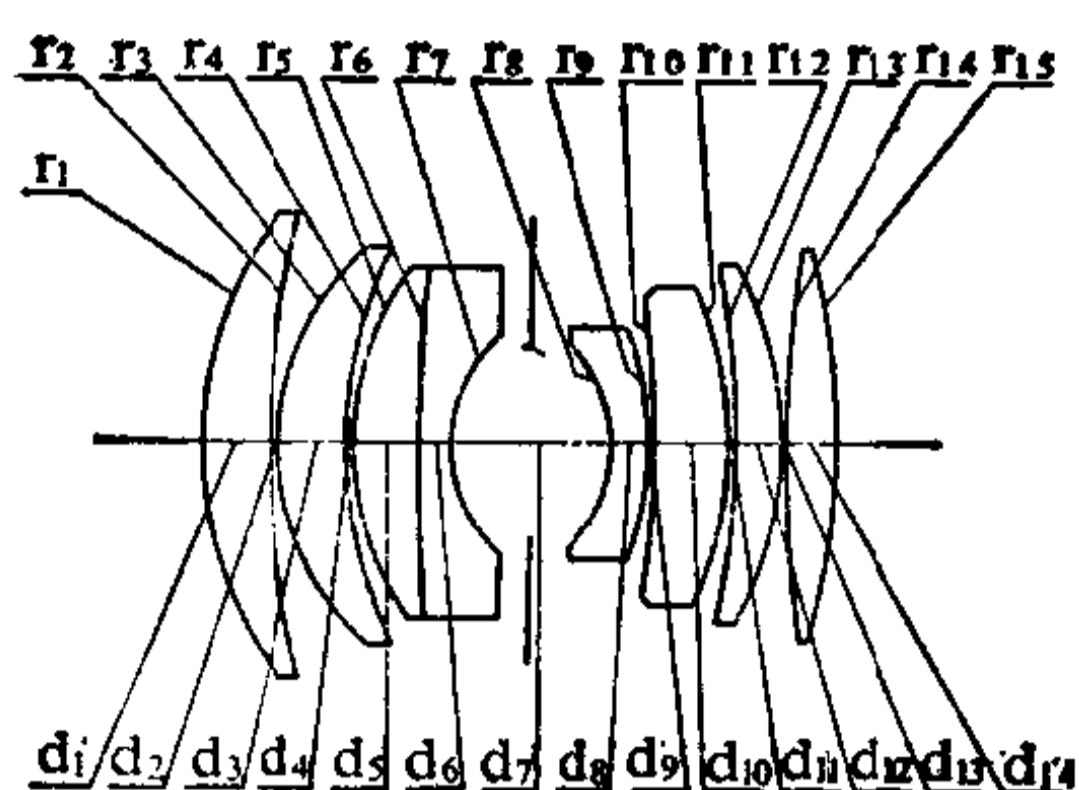

序号	r	d	n_e	v_d	序号	r	d	n_e	v_d
1	103.48	18.20	1.69978	55.62	9	-90.40	0.80		
2	251.28	0.80			10	-265.79	20.00	1.71615	53.98
3	71.41	18.20	1.69978	55.62	11	-109.94	1.00		
4	121.60	0.80			12	-310.99	13.80	1.71615	53.98
5	82.29	18.20	1.69978	55.62	13	-104.46	1.00		
6	785.20	7.50	1.74618	28.29	14	386.94	13.80	1.71615	53.98
7	39.39	43.18*			15	-198.77			
8	-38.48	10.00	1.80922	39.57					

$43.18^* = 21.59 + 21.59$

	ΣS_1	ΣS_2	ΣS_3	ΣS_4	ΣS_5	HI	QP(1 ω)
	-0.00429	-0.00115	-0.00580	-0.00964	0.17778	49.3	1.6%
h 或 ω %	LA'	$\Delta H'$	x'_i	x'_e	$x'_i - x'_e$	K'_{T1}	$K'_{I0.7}$
100	-0.0605	0.8003	-1.1908	-0.4919	-0.6989	-0.02774	-0.00707
70	-0.0506	0.2656	-0.4496	-0.2257	-0.2239	-0.02791	-0.00714

注: 1. $M = 0.05^*$;

2. 以上象差值是按 $l = -\infty$ 计算的。

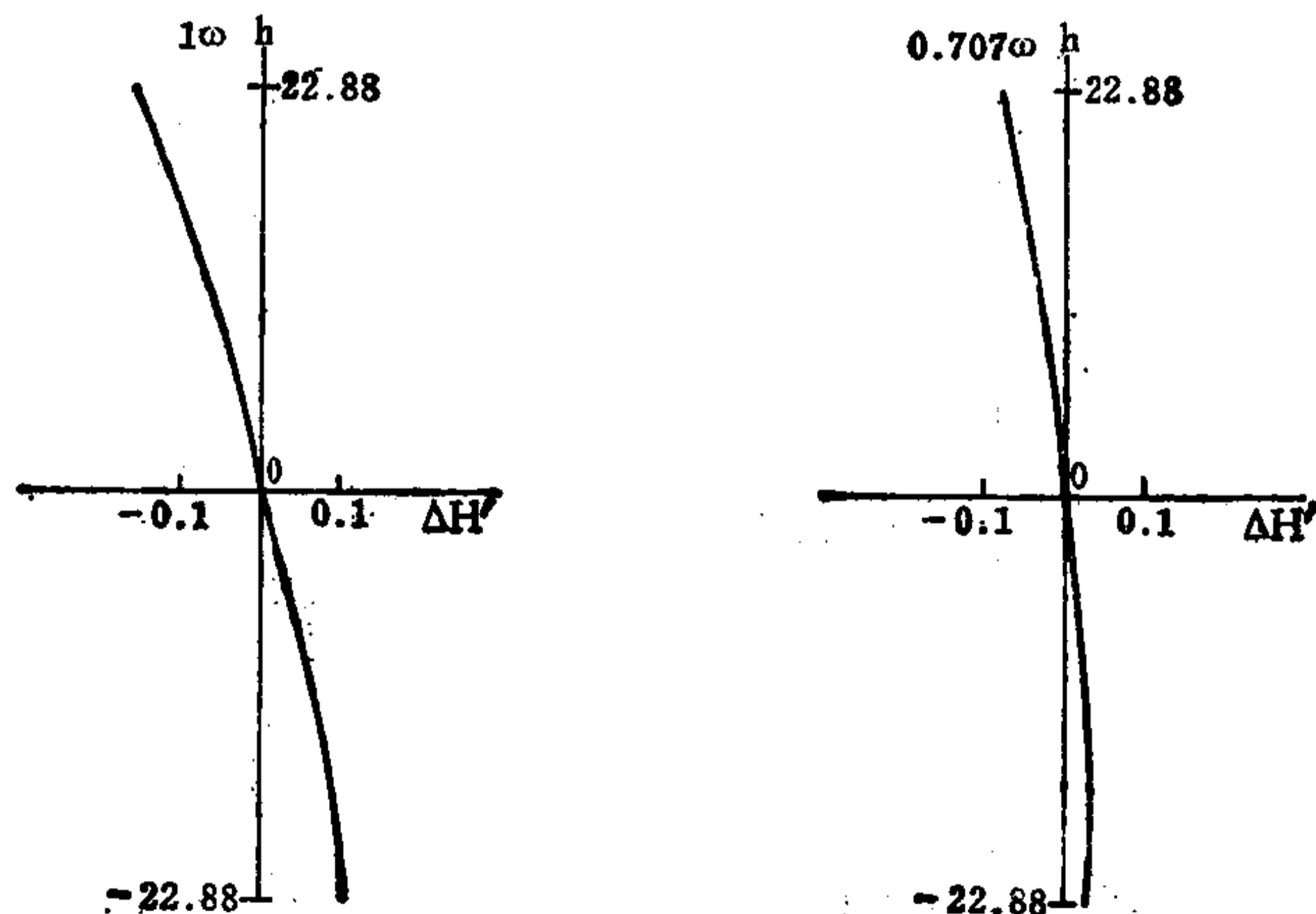
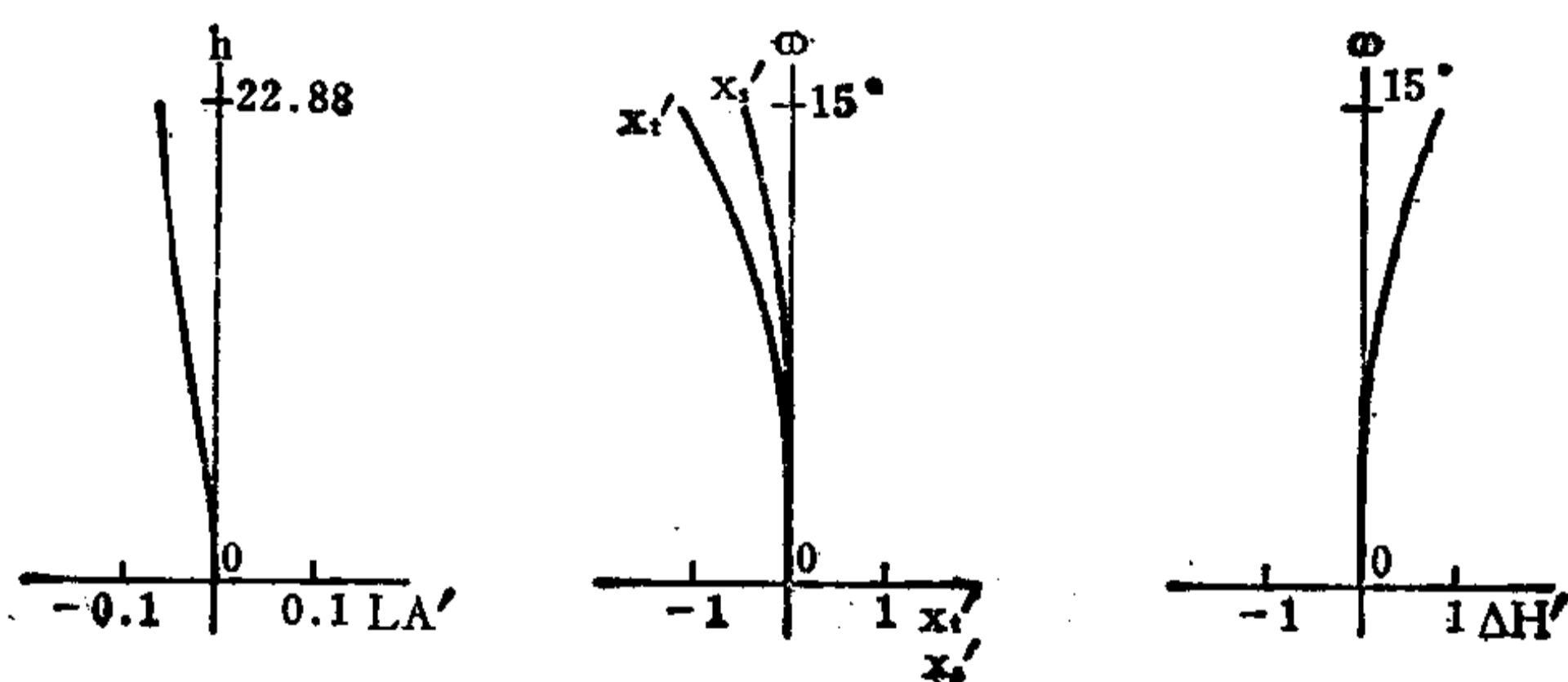

编号: 05-04-036

精密透镜系统

E. F. L = 180

B. F. L = 59.6

FNo. = 4

F. A. = ± 15°**

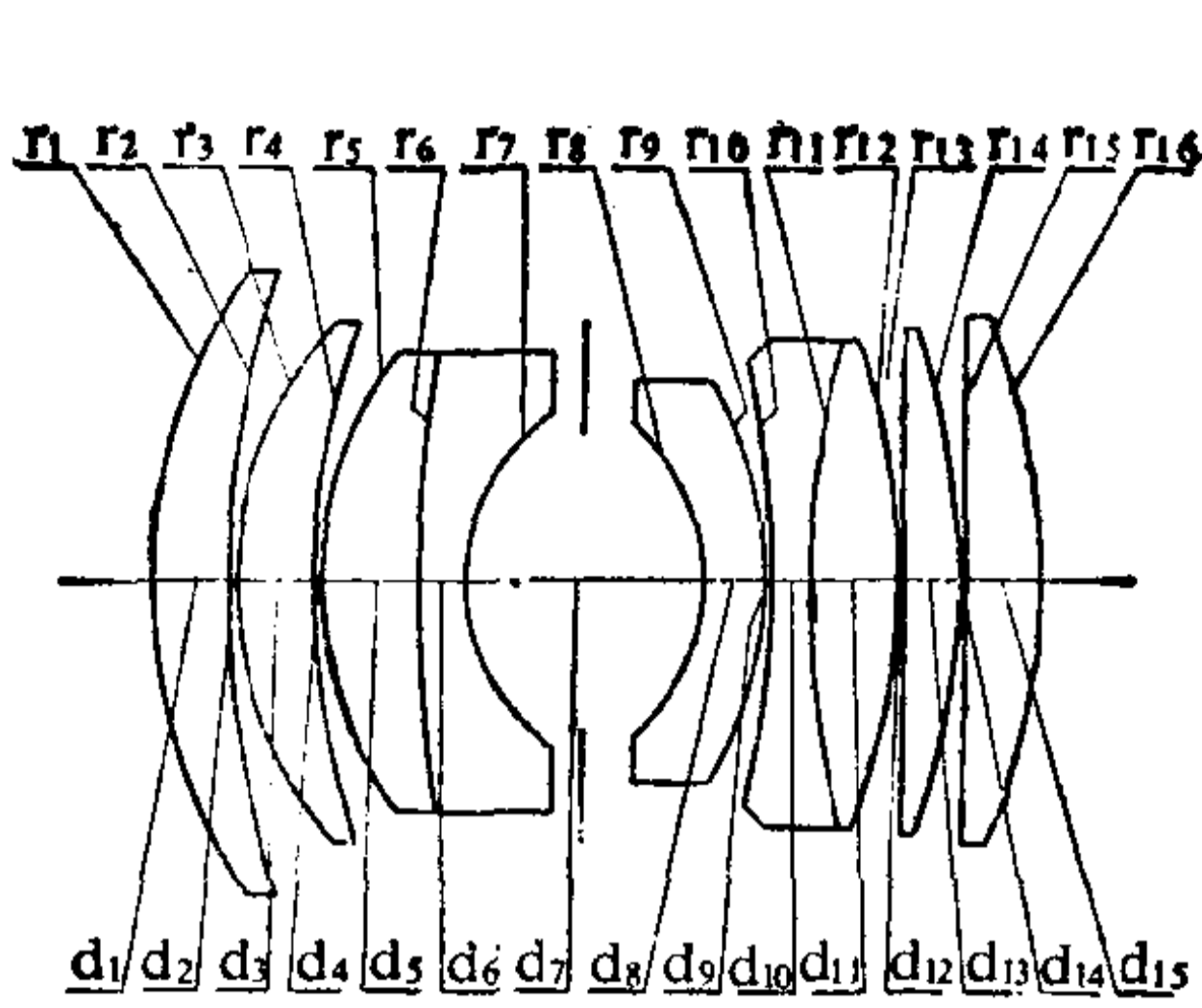

序号	r	d	n _e	v _d	序号	r	d	n _e	v _d
1	102.05	13.80	1.71615	53.98	9	-73.86	0.70		
2	180.27	0.70			10	-181.15	6.80	1.74795	44.78
3	70.37	14.60	1.69978	55.62	11	159.36	16.50	1.62540	57.06
4	140.85	0.70			12	-129.29	0.70		
5	70.34	17.50	1.69660	53.34	13	∞	10.00	1.71615	53.98
6	333.68	8.00	1.73429	28.46	14	-142.28	0.70		
7	36.28	42.06*			15	∞	13.50	1.71615	53.98
8	-38.79	11.20	1.74795	44.78	16	-124.67			

42.06* = 21.03 + 21.03

	ΣS ₁	ΣS ₂	ΣS ₃	ΣS ₄	ΣS ₅	HI	QP(1ω)
	-0.00439	-0.00079	-0.00498	-0.00994	0.12765	48.3	1.14%
h 或 ω%	LA'	ΔH'	x _t '	x _s '	x _t ' - x _s '	K _{T1}	K _{T0.7}
100	-0.0585	0.5524	-0.9143	-0.4089	-0.5054	-0.02489	-0.00832
70	-0.0508	0.1874	-0.3878	-0.2056	-0.1822	-0.02531	-0.00737

注: 1. M = 0.05*;

2. 以上象差值是按 l = -∞ 计算的。

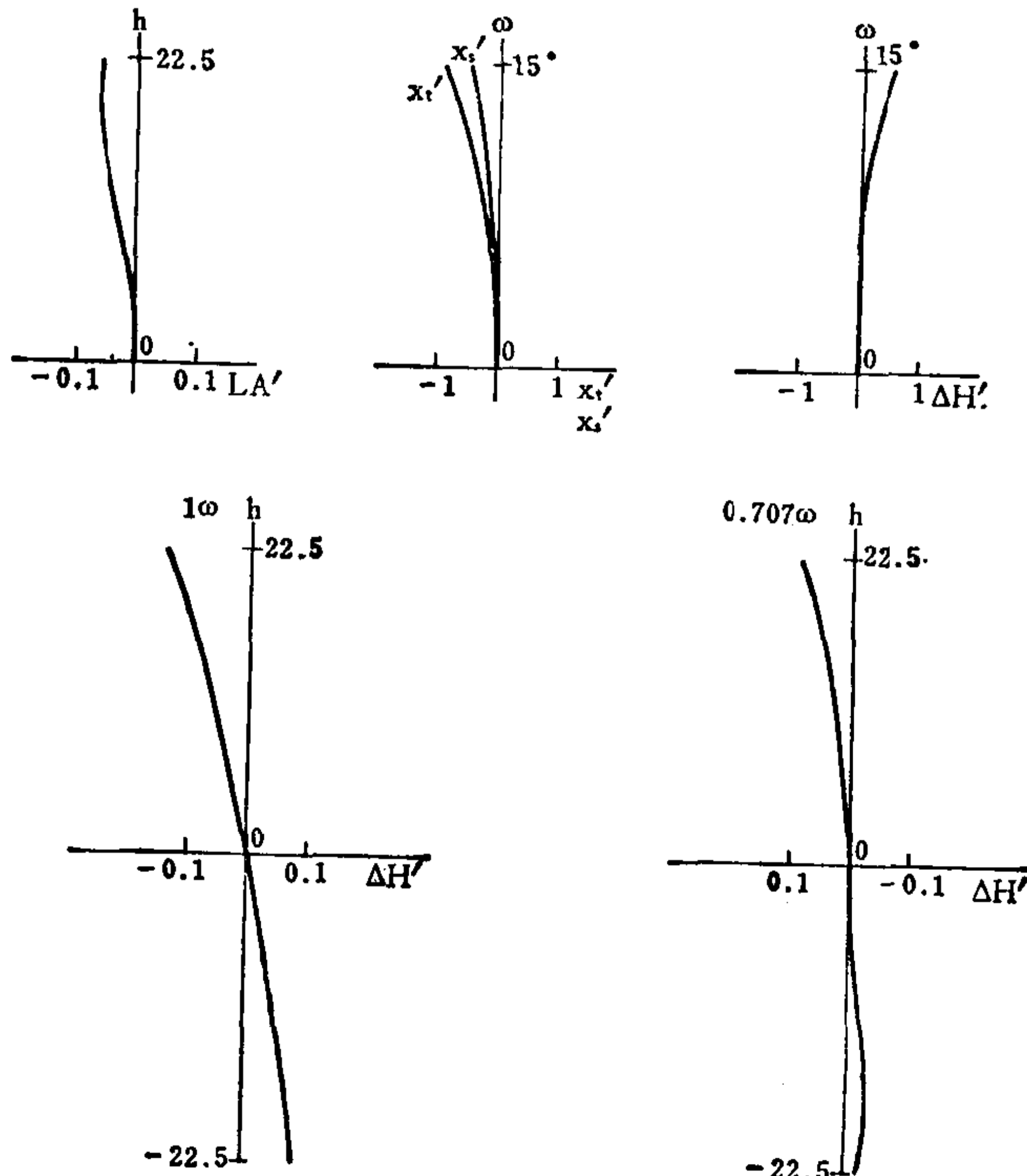

编号: 05-04-037

小倍率远距离照相镜头

E. F. L = 100

B. F. L = 25.5

FNo. = 5

F. A. = ± 6.07°

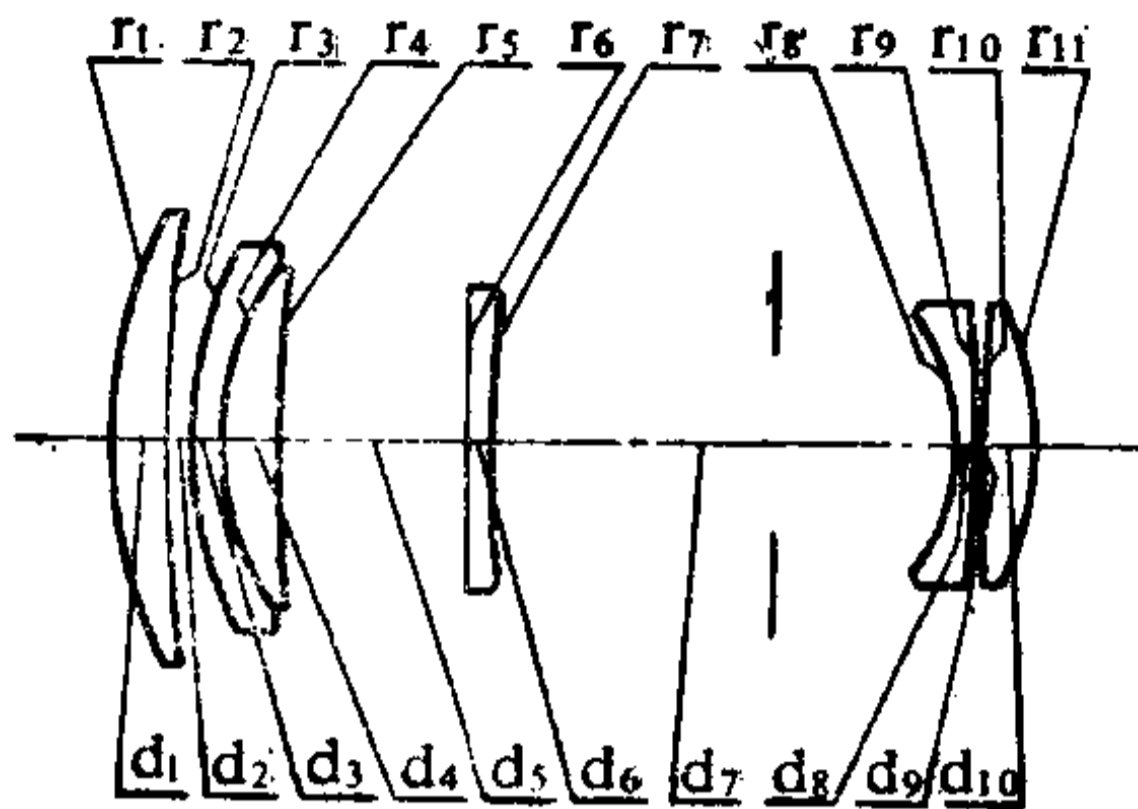

序号	r	d	n _d	v _d	序号	r	d	n _d	v _d
1	27.37	3.0	1.4875	70.2	7	59.87	25.0*		
2	87.09	1.5			8	-12.05	1.0	1.7130	54.0
3	24.47	1.5	1.7283	28.5	9	-83.24	0.5		
4	15.93	3.0	1.5014	56.4	10	355.59	2.5	1.5927	35.5
5	76.67	10.0			11	-18.27			
6	∞	1.5	1.7440	44.8					

25.0* = 15.0 + 10.0

	ΣS ₁	ΣS ₂	ΣS ₃	ΣS ₄	ΣS ₅	HI	QP(1ω)
	-0.00448	0.00254	-0.00128	-0.00037	0.02361	10.6	1%
h 或 ω %	LA'	ΔH'	x _t '	x _s '	x _t ' - x _s '	K _{T1}	K _{T0.7}
100	-0.0045	0.1085	0.0026	-0.0589	0.0615	-0.07230	-0.02006
70	-0.0609	0.0402	-0.0511	-0.0354	-0.0157	-0.03072	-0.00429

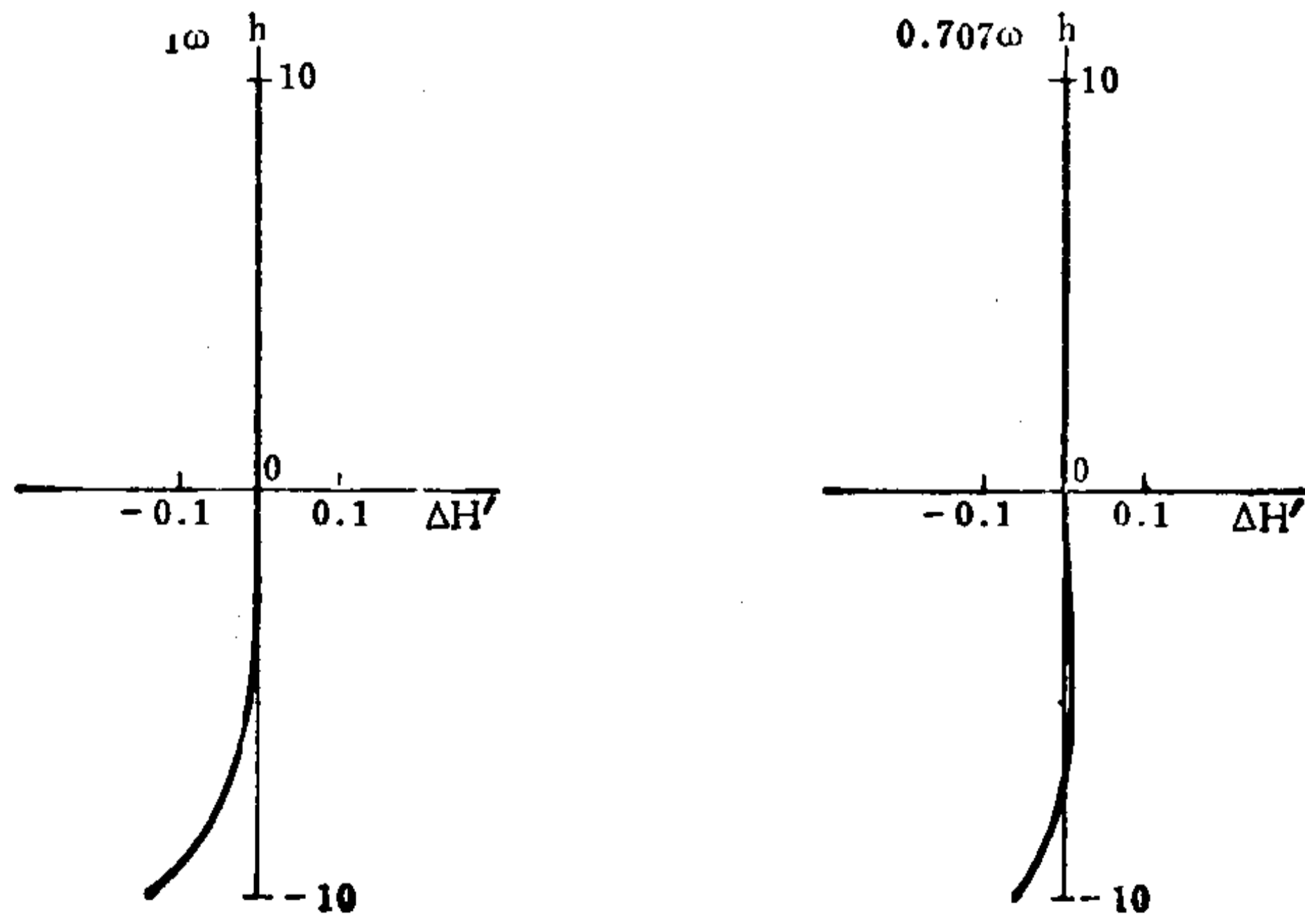
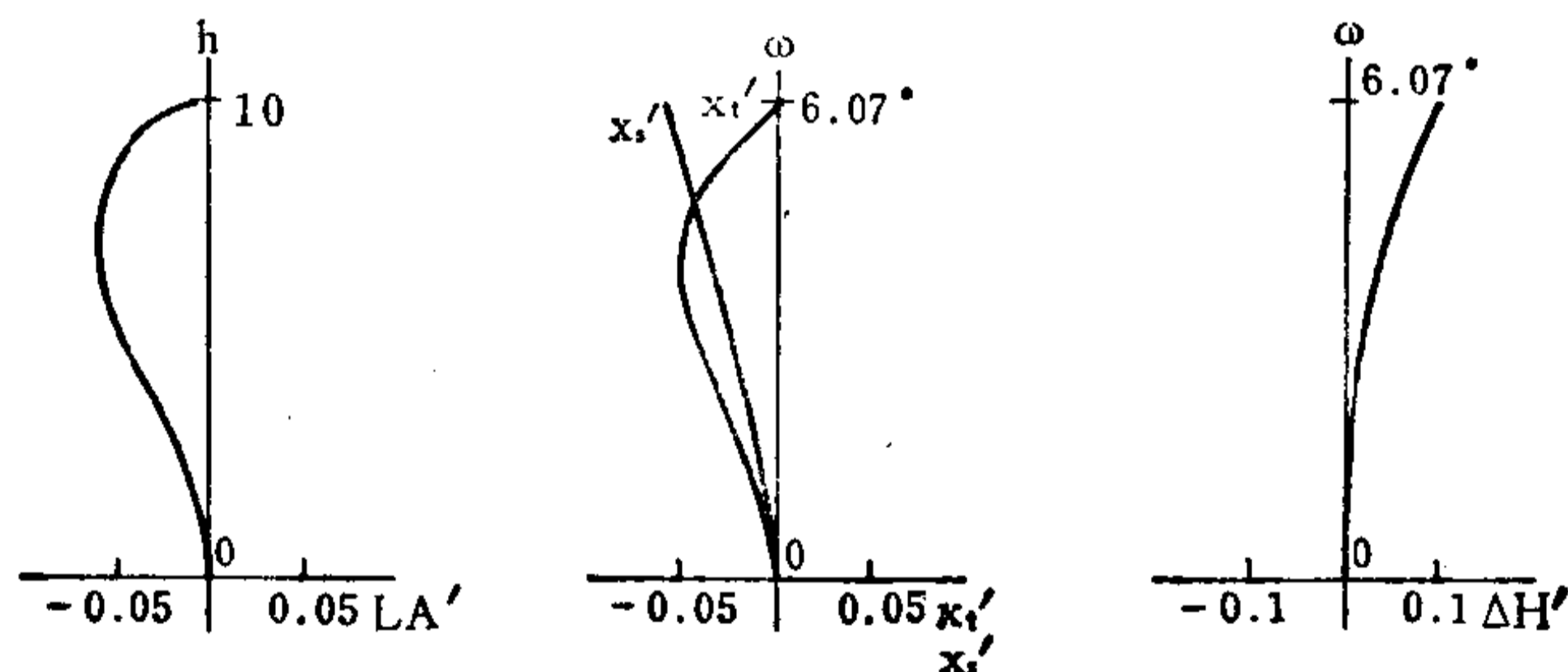

编号: 05-04-038

小倍率远距离照相镜头

E. F. L = 100.2

B. F. L = 24.97

FNo. = 5

F. A. = ± 6.07°

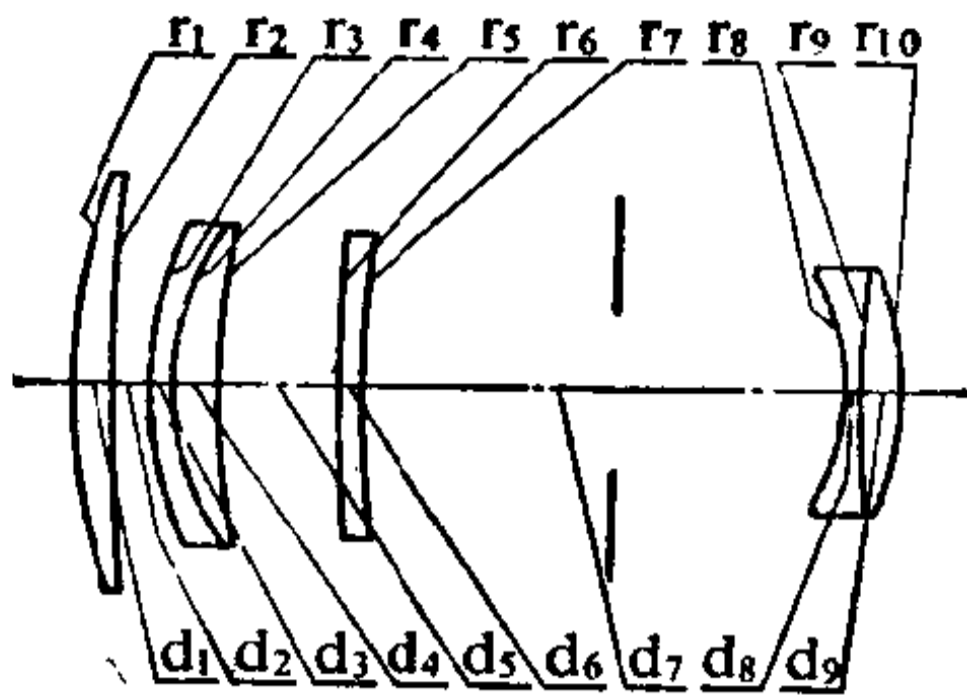

序号	r	d	n _d	v _d	序号	r	d	n _d	v _d
1	38.54	2.5	1.4875	70.2	6	124.83	1.5	1.7408	27.8
2	150.27	2.5			7	74.01	31.0*		
3	24.61	1.5	1.7400	28.3	8	-14.38	1.0	1.7130	54.0
4	17.85	3.0	1.5163	64.2	9	80.98	2.5	1.6364	35.4
5	50.55	7.5			10	-20.18			

31.0* = 16.0 + 15.0

	ΣS ₁	ΣS ₂	ΣS ₃	ΣS ₄	ΣS ₅	HI	QP(1ω)
	-0.00321	0.00037	-0.00048	0.00026	0.03909	10.6	1.9%
h 或 ω %	LA'	ΔH'	x' _t	x' _s	x' _t - x' _s	K' _{T1}	K' _{r0.7}
100	0.0032	0.2038	-0.0032	-0.0124	0.0092	-0.02960	-0.00750
70	-0.0423	0.0708	-0.0161	-0.0058	-0.0103	-0.01655	-0.00345

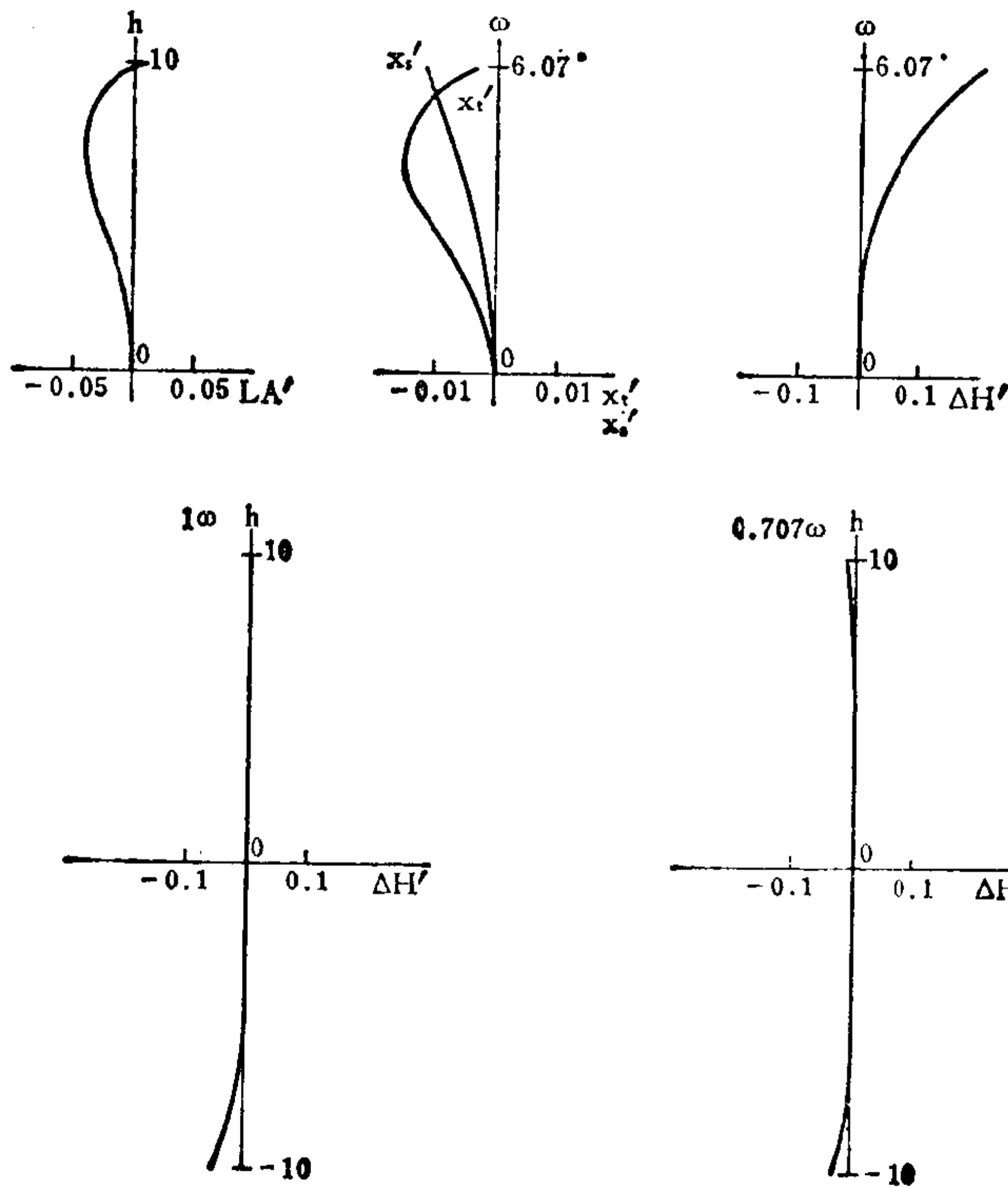

编号: 05-04-039

远 距 离 照 相 镜 头

E. F. L = 1.0

B. F. L = 0.2697

FNo. = 6.3

F. A. = ± 3.09°

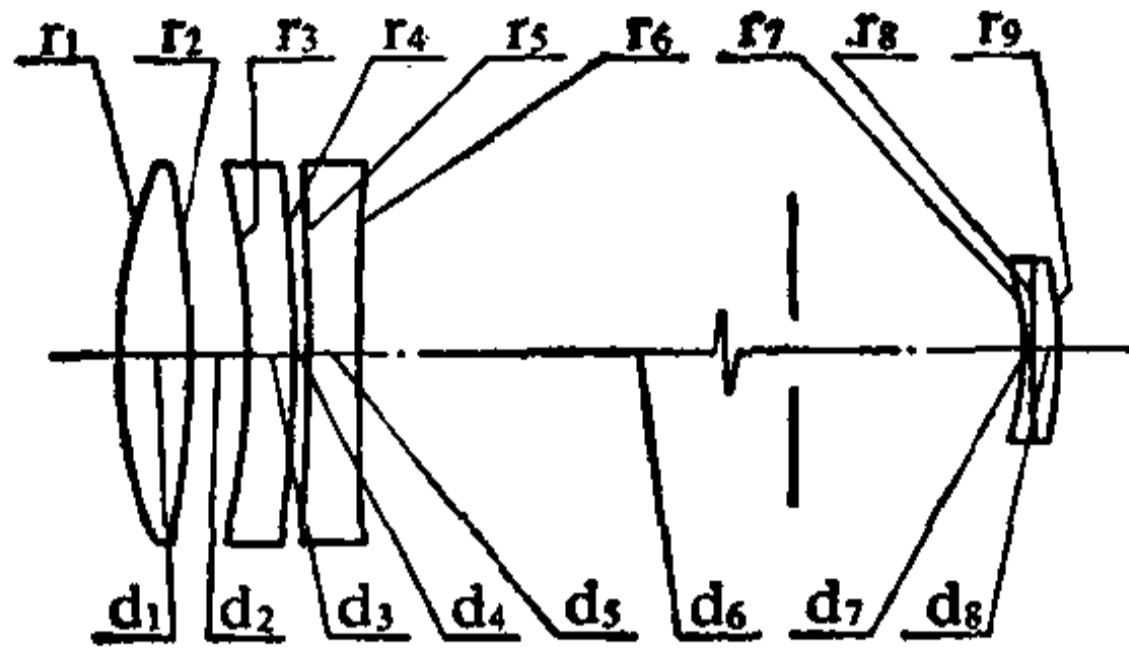

序号	r	d	n	v	序号	r	d	n	v
1	0.22373	0.03022	1.48749	70.1	6	3.27585	0.35573*		
2	-0.40612	0.02608			7	-0.13307	0.00915	1.65160	58.6
3	-0.31658	0.01900	1.74950	35.2	8	1.13748	0.01303	1.60340	38.0
4	-0.88263	0.00544			9	-0.20273			
5	-1.64903	0.02164	1.59270	35.6					

$0.35573^* = 0.25573 + 0.10000$

	ΣS_1	ΣS_2	ΣS_3	ΣS_4	ΣS_5	HI	QP(1 ω)
	-0.000034	0.000011	-0.000002	0.000001	0.000042	0.054	0.5%
h 或 ω %	LA'	$\Delta H'$	x'_t	x'_s	$x'_t - x'_s$	K'_{T1}	$K'_{T0.7}$
100	0.00002	0.00026	-0.00033	-0.00007	-0.00026	0.002196	0.000145
70	-0.00066	0.00009	-0.00016	-0.00004	-0.00012	0.000242	-0.000008

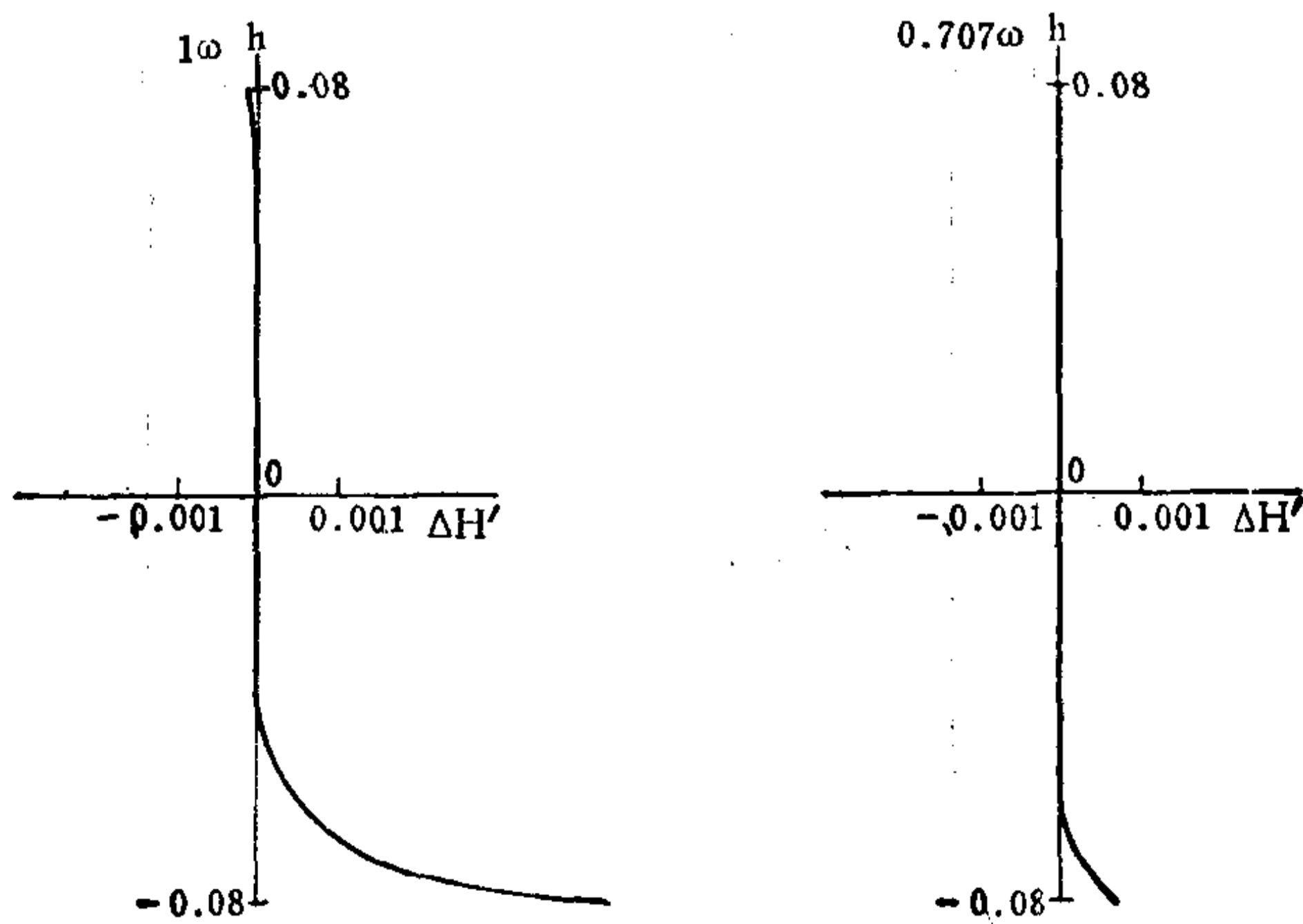
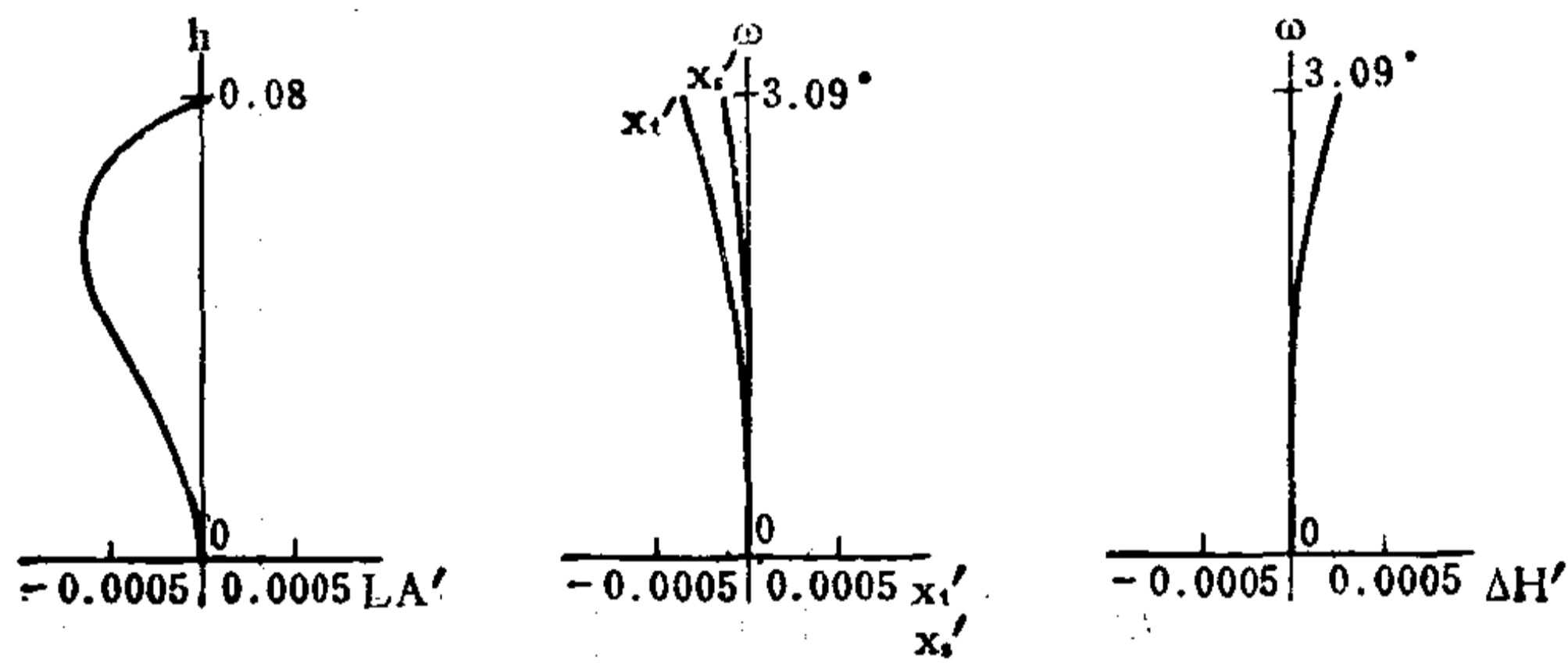

编号: 05-04-040

消色差远距物镜

E. F. L = 300

B. F. L = 70

FNo. = 4.5

F. A. = $\pm 4.2^\circ$

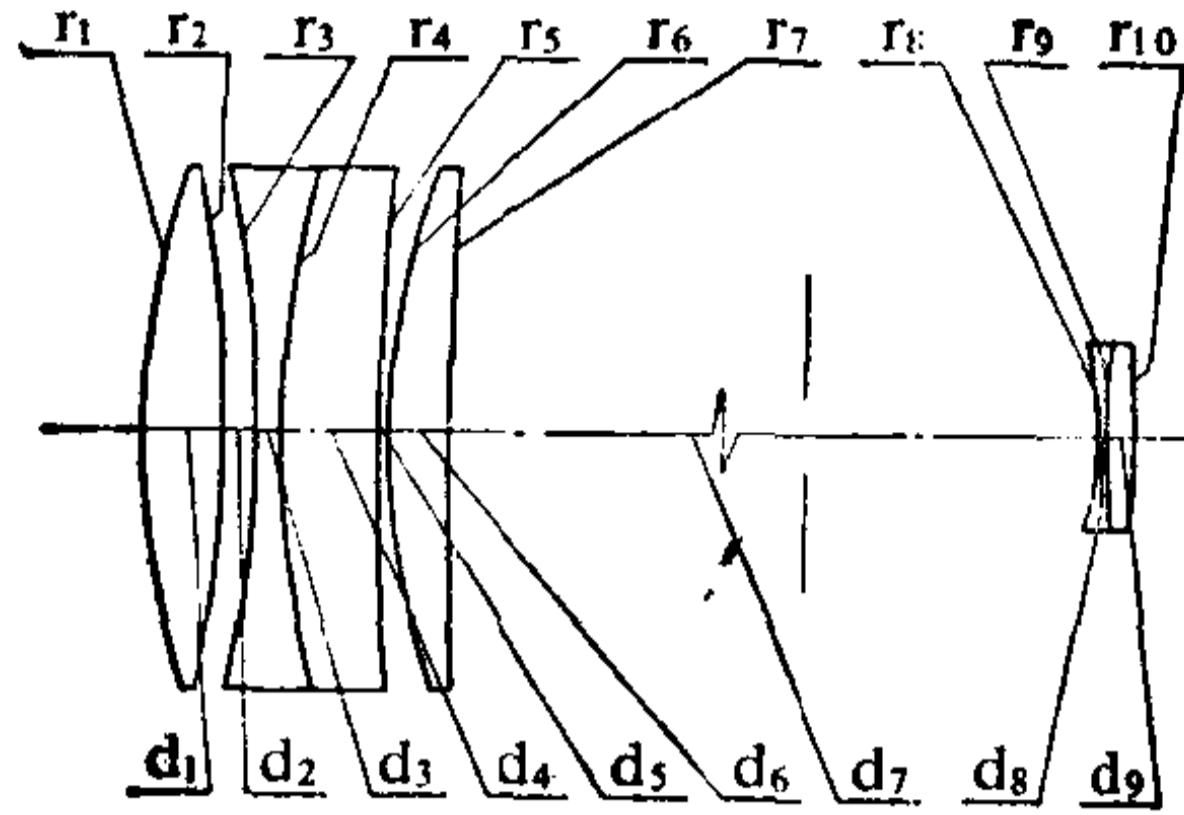

序号	r	d	n	v	序号	r	d	n	v
1	106.00	11.0	1.48606	81.5	6	95.00	7.7	1.48606	81.5
2	-151.00	4.0			7	878.80	119.3*		
3	-144.00	3.0	1.74400	44.9	8	-43.00	1.0	1.62041	60.3
4	130.00	12.0	1.63930	45.0	9	150.00	3.5	1.62004	36.3
5	650.00	1.0			10	-104.82			

119.3* = 69.0 + 50.3

	ΣS_1	ΣS_2	ΣS_3	ΣS_4	ΣS_5	HI	QP(1 ω)
	-0.00385	0.00017	-0.00391	0.00458	0.04798	21.9	1%
h 或 ω %	LA'	$\Delta H'$	x'_t	x_s	$x'_t - x_s$	K'_{11}	$K'_{10.7}$
100	-0.00099	0.2201	-0.2563	0.0252	-0.2815	0.19537	0.01660
70	-0.02847	0.0771	-0.1344	0.0134	-0.1478	0.06035	0.00306

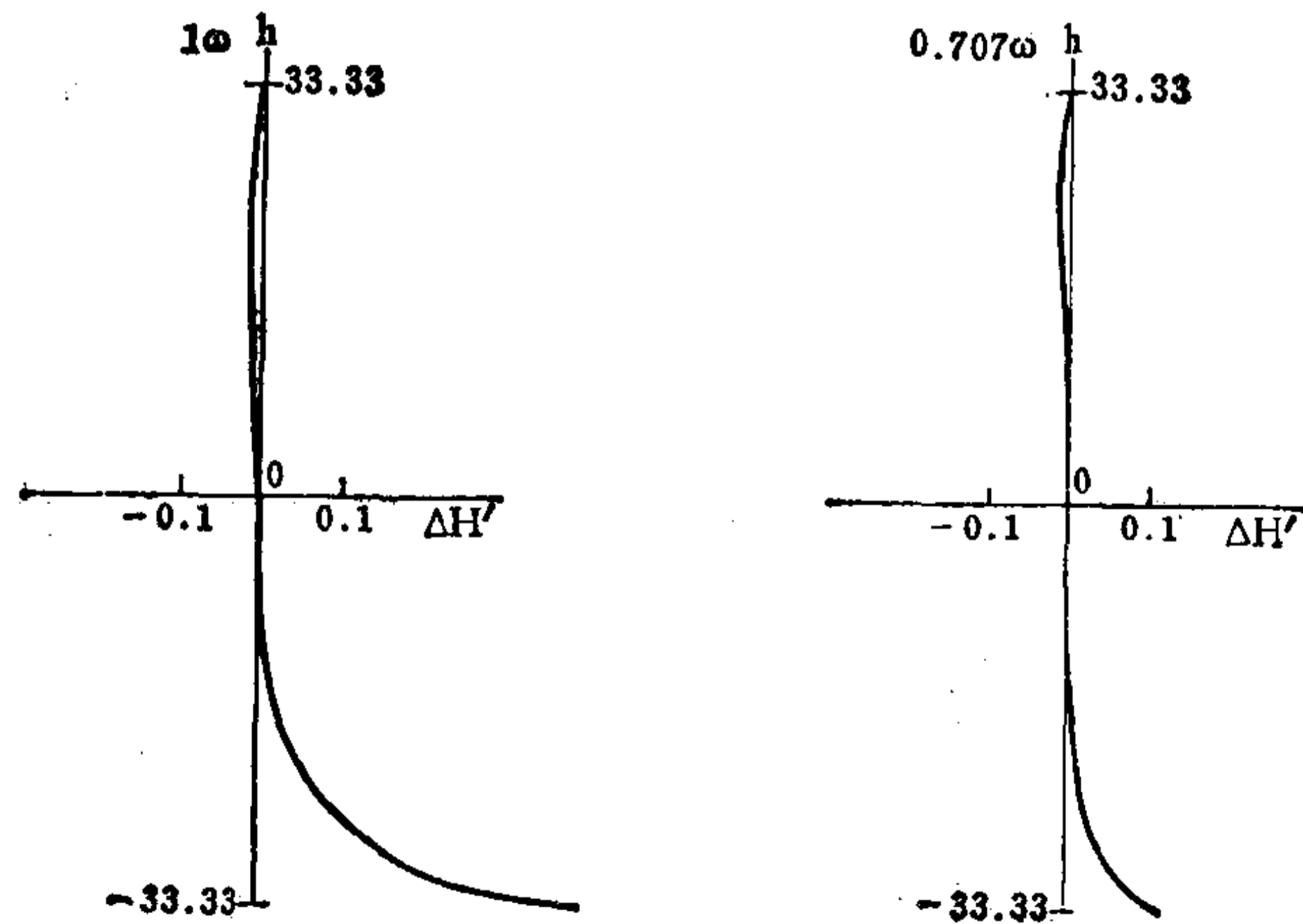
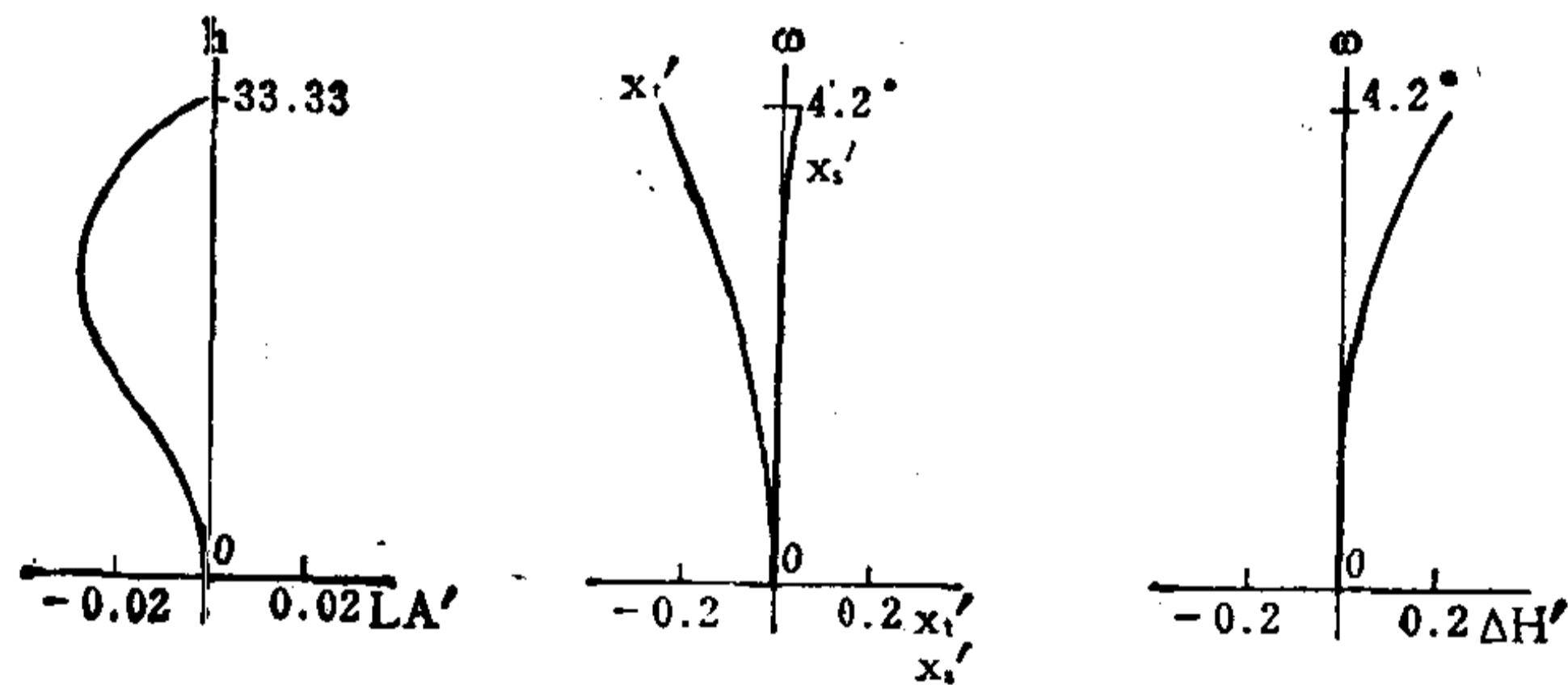

编号: 05-04-041

消色差远距离物镜

E.F.L=1144.6

B.F.L=328.7

FNo. = 10.5

F.A. = ± 2°

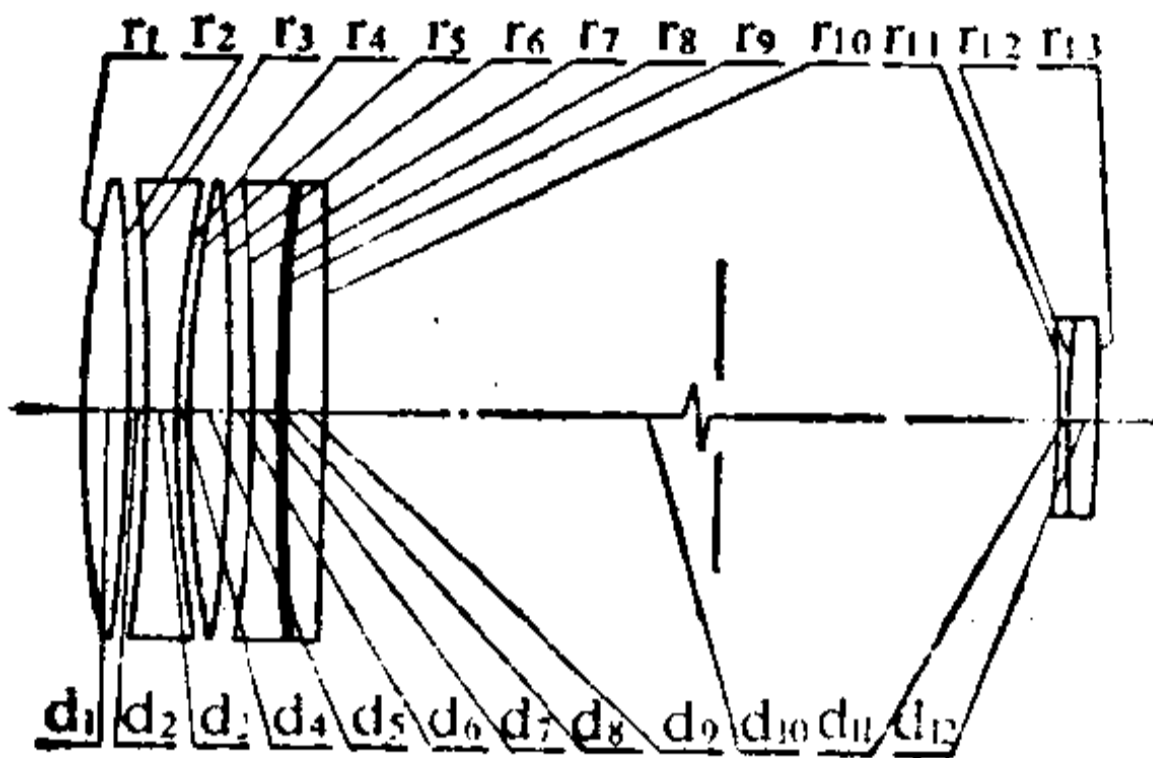

序号	r	d	n	v	序号	r	d	n	v
1	310.00	11.0	1.61405	55.1	8	841.00	1.0		
2	-525.00	5.0			9	700.00	10.0	1.62374	47.0
3	-630.00	7.5	1.61150	44.3	10	-2386.10	533.0*		
4	313.00	4.0			11	-190.00	2.0	1.51680	64.2
5	341.30	10.0	1.48606	81.5	12	310.00	7.0	1.62374	47.0
6	-557.00	7.0			13	-472.83			
7	-413.00	7.5	1.71300	53.9					

$533.0^* = 280.0 + 253.0$

	ΣS_1	ΣS_2	ΣS_3	ΣS_4	ΣS_5	HI	QP(1 ω)
	-0.00202	-0.00013	-0.00076	-0.00017	0.00359	40.1	0.09%
h 或 ω %	LA'	$\Delta H'$	x'_t	x'_s	$x'_t - x'_s$	K'_{T1}	$K'_{T0.7}$
100	-0.5730	0.0377	-0.5737	-0.2136	-0.3601	0.01674	0.00322
70	-0.2504	0.0133	-0.2794	-0.1052	-0.1742	0.00843	0.00117

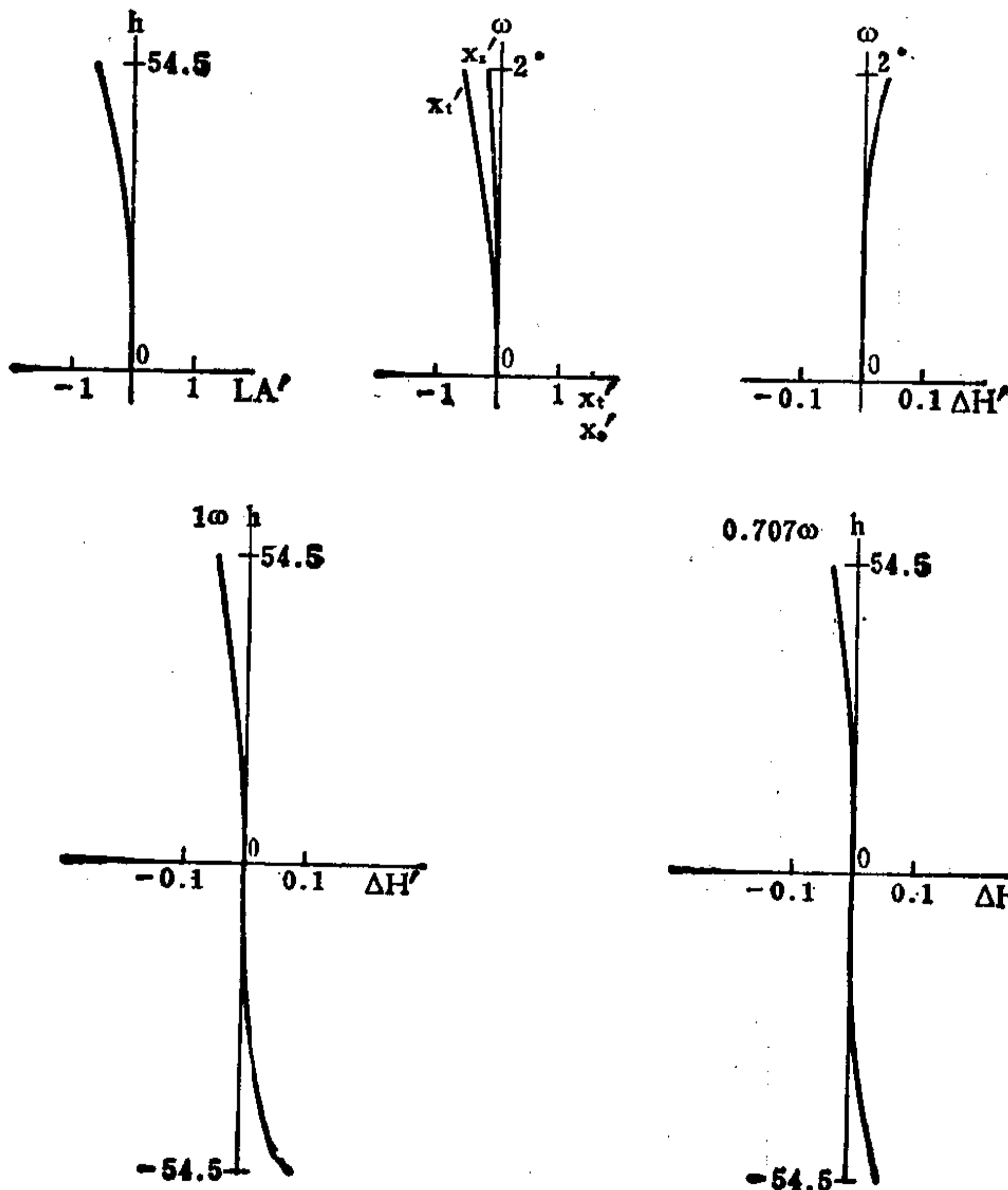

编号: 05-04-042

小倍率望远镜式远摄透镜系统

E. F. L = 100

B. F. L = 25.05

FNo. = 4.5

F. A. = ± 3°

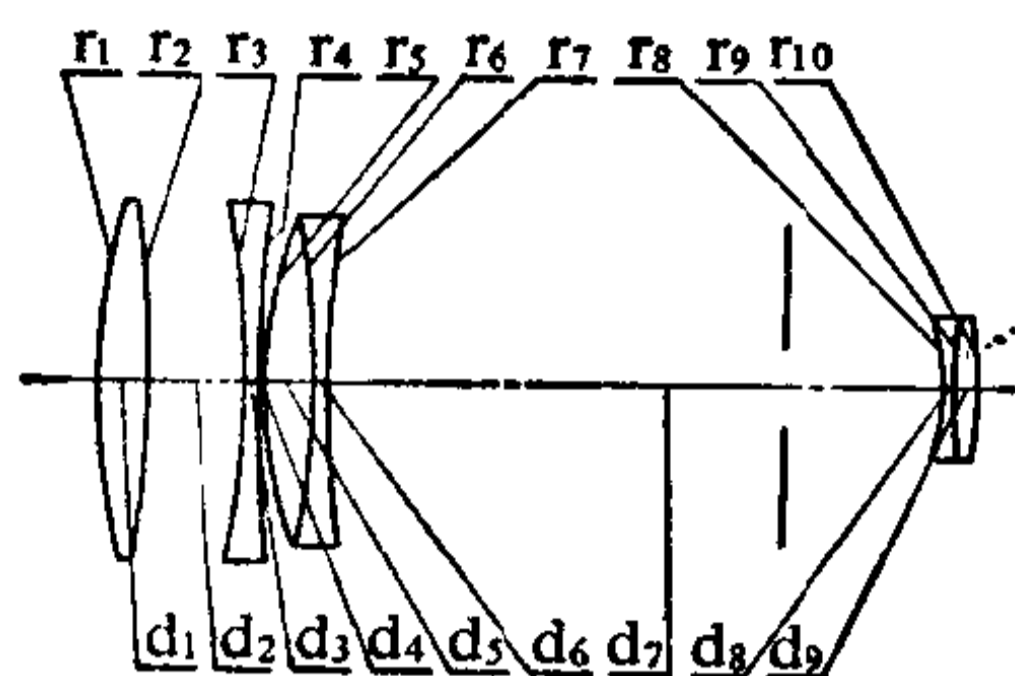

序号	r	d	n	v	序号	r	d	n	v
1	44.199	3.00	1.48749	70.2	6	-59.866	1.00	1.61340	43.8
2	-79.671	6.25			7	80.935	38.50*		
3	-57.444	1.00	1.70154	41.1	8	-14.064	0.75	1.67790	55.3
4	158.310	0.20			9	44.298	1.25	1.72342	37.9
5	29.442	3.00	1.61800	63.4	10	-24.649			

38.50* = 28.50 + 10.00

	ΣS ₁	ΣS ₂	ΣS ₃	ΣS ₄	ΣS ₅	HI	QP(1ω)
	-0.001445	0.000017	-0.000163	0.000430	0.005025	5.2	0.4%
h 或 ω %	LA'	ΔH'	x' _t	x' _s	x' _t - x' _s	K _{T1}	K _{T0.7}
100	-0.0012	0.0229	-0.0091	0.0091	-0.0182	0.01088	0.00229
70	-0.0151	0.0080	-0.0026	0.0050	-0.0076	0.00350	0.00061

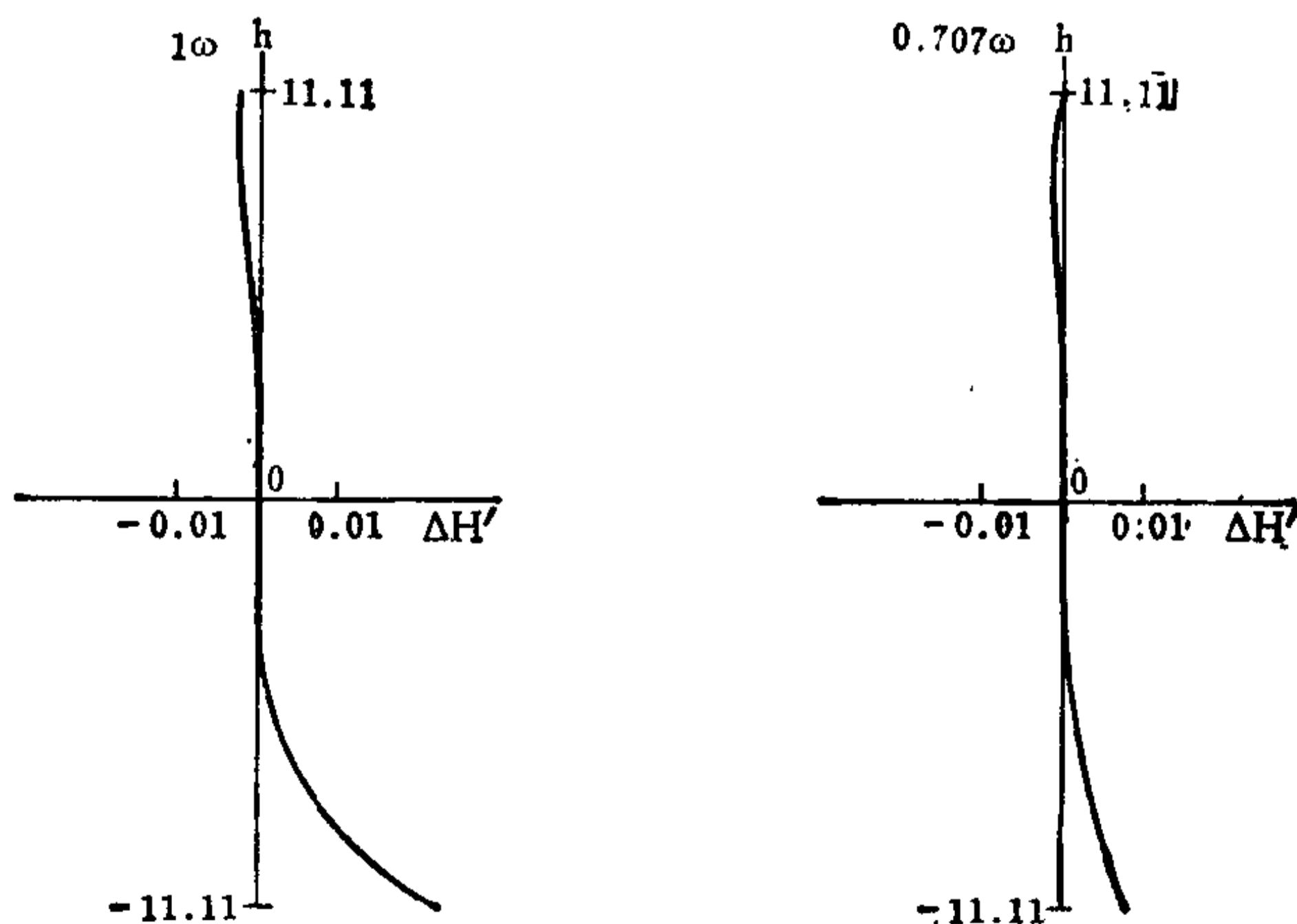
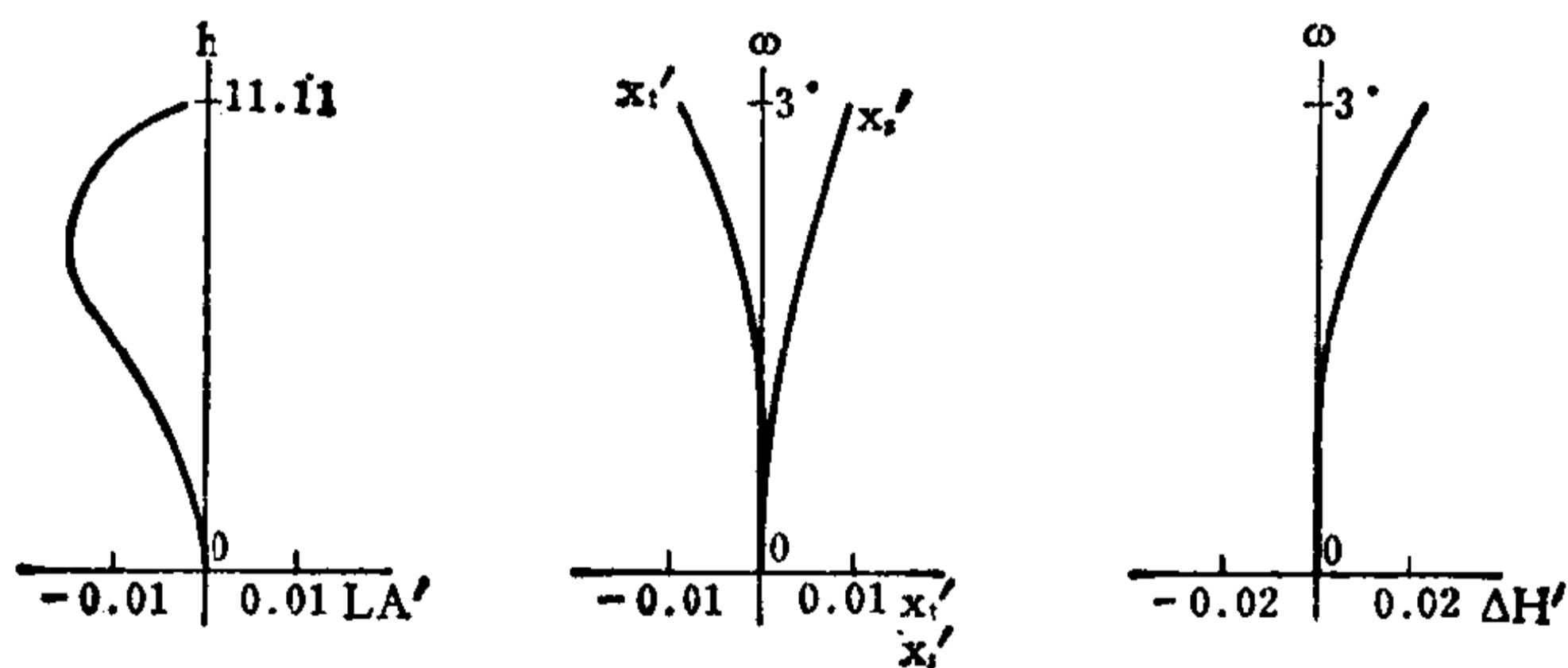

编号: 05-04-043

大孔径长焦距透镜系统

E. F. L = 1.0

B. F. L = 0.435

FNo. = 2.8

F. A. = $\pm 9^\circ$

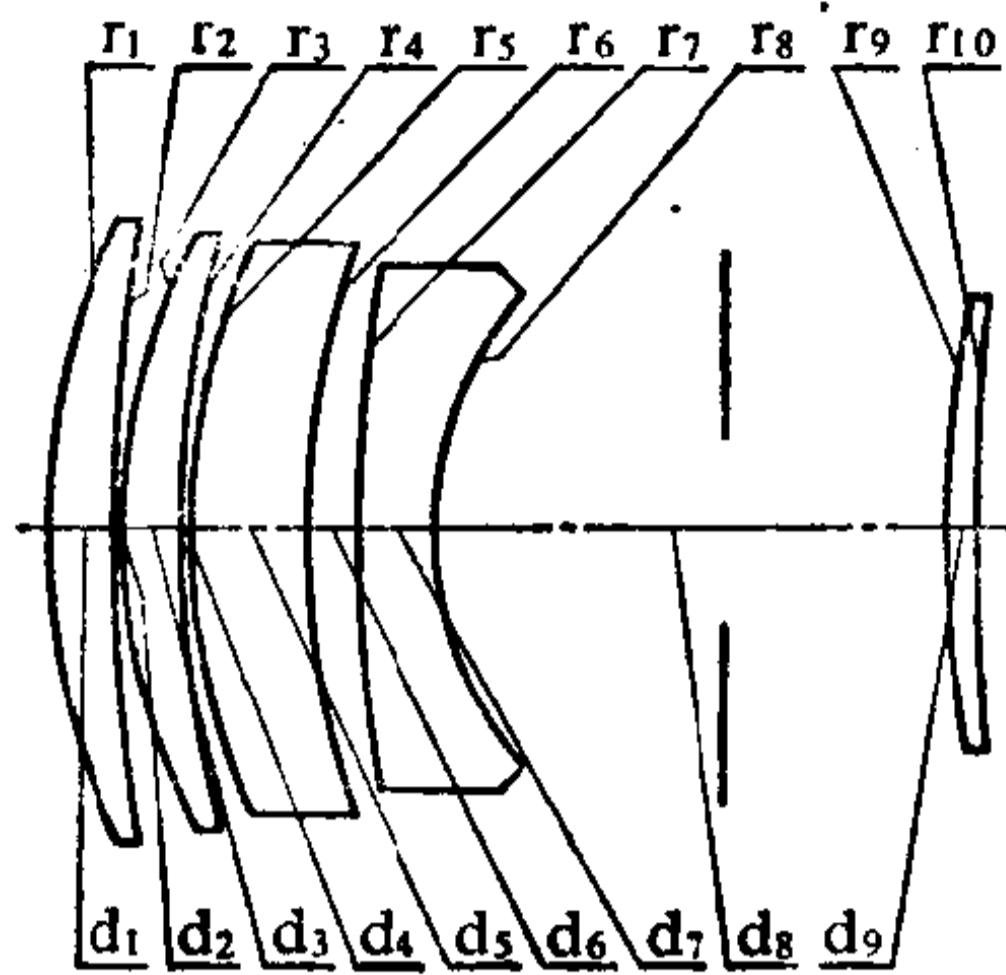

序号	r	d	n	v	序号	r	d	n	v
1	0.3847	0.0392	1.63854	55.38	6	0.4620	0.0260		
2	1.5003	0.0007			7	0.9685	0.0409	1.78470	26.22
3	0.3465	0.0317	1.61700	62.79	8	0.1957	0.2758*		
4	0.5969	0.0025			9	0.6435	0.0150	1.80518	25.43
5	0.3748	0.0638	1.70154	41.10	10	1.8672			

$0.2758^* = 0.1558 + 0.1200$

	ΣS_1	ΣS_2	ΣS_3	ΣS_4	ΣS_5	HI	QP(1 ω)
	-0.000163	0.000027	-0.000015	-0.000065	0.000365	0.158	0.51%
h 或 ω %	LA'	$\Delta H'$	x'_i	x'_s	$x'_i - x'_s$	K'_{T1}	$K'_{T0.7}$
100	-0.000078	0.000811	-0.000696	-0.000759	0.000063	-0.000379	-0.000054
70	-0.000717	0.000328	-0.000584	-0.000511	-0.000073	-0.000172	-0.000008

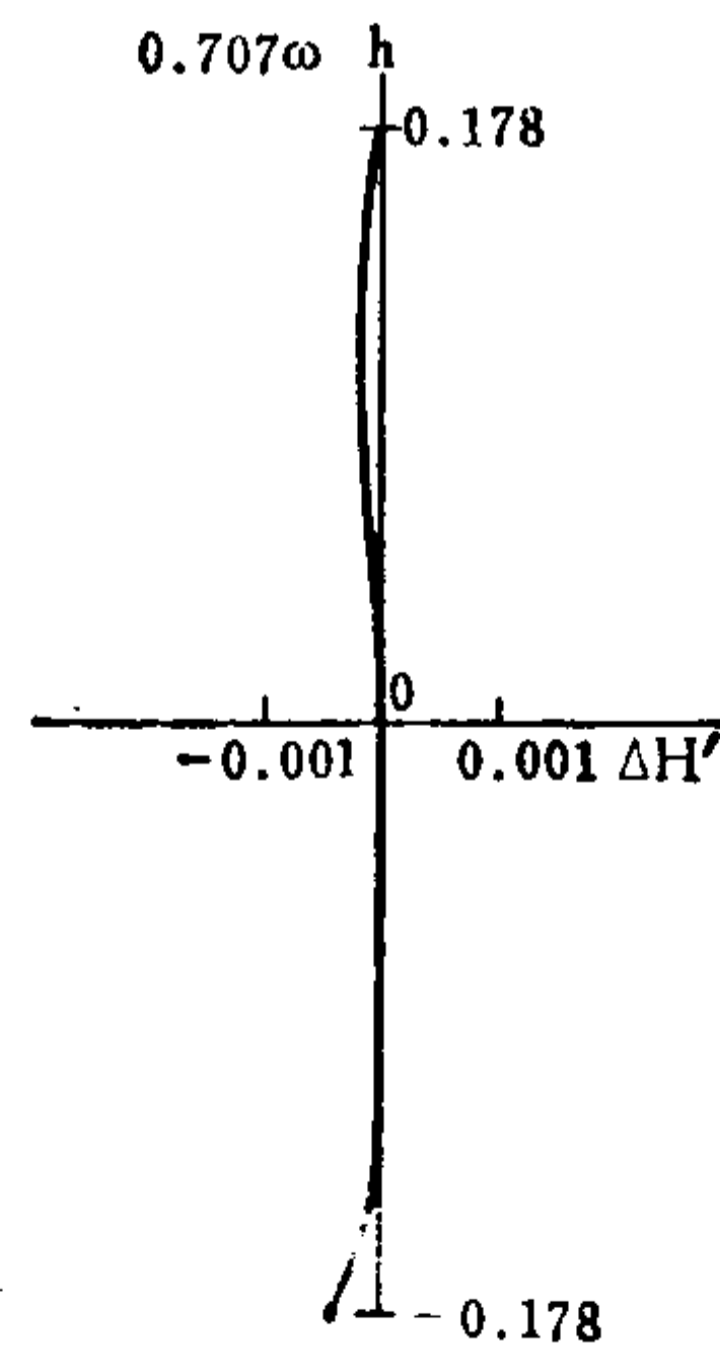
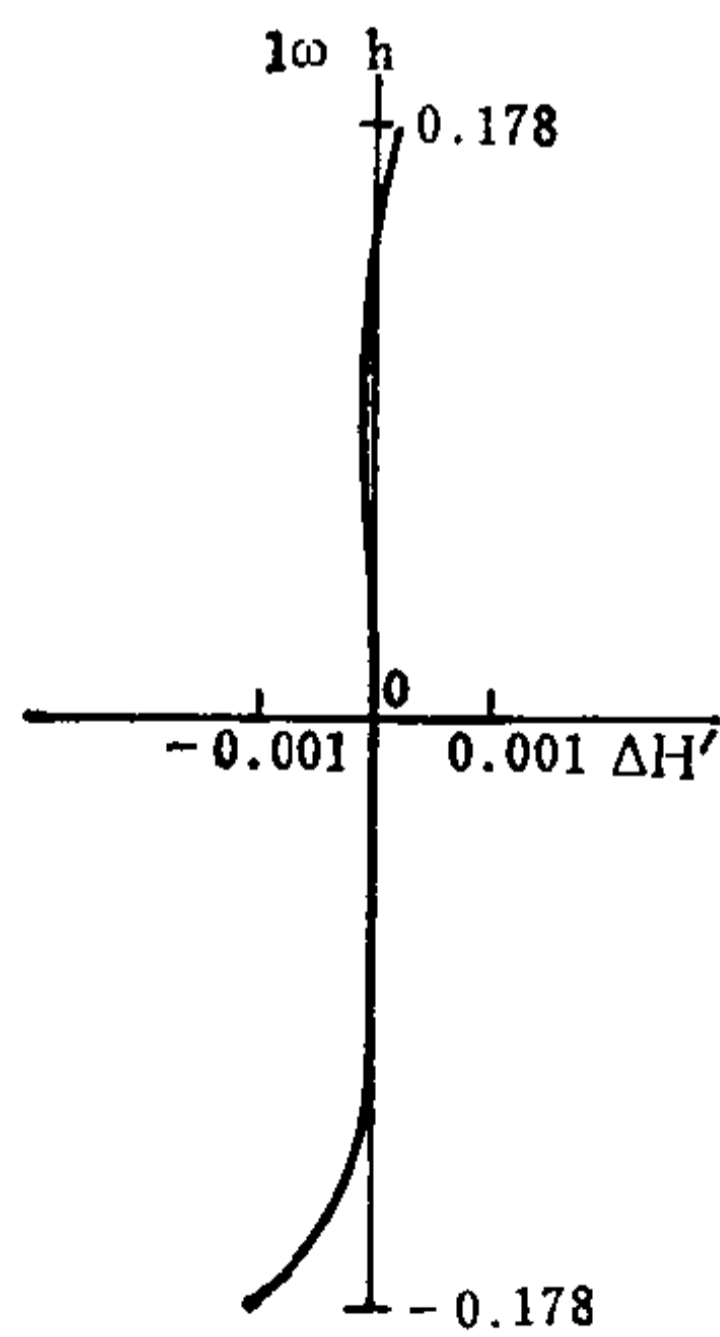
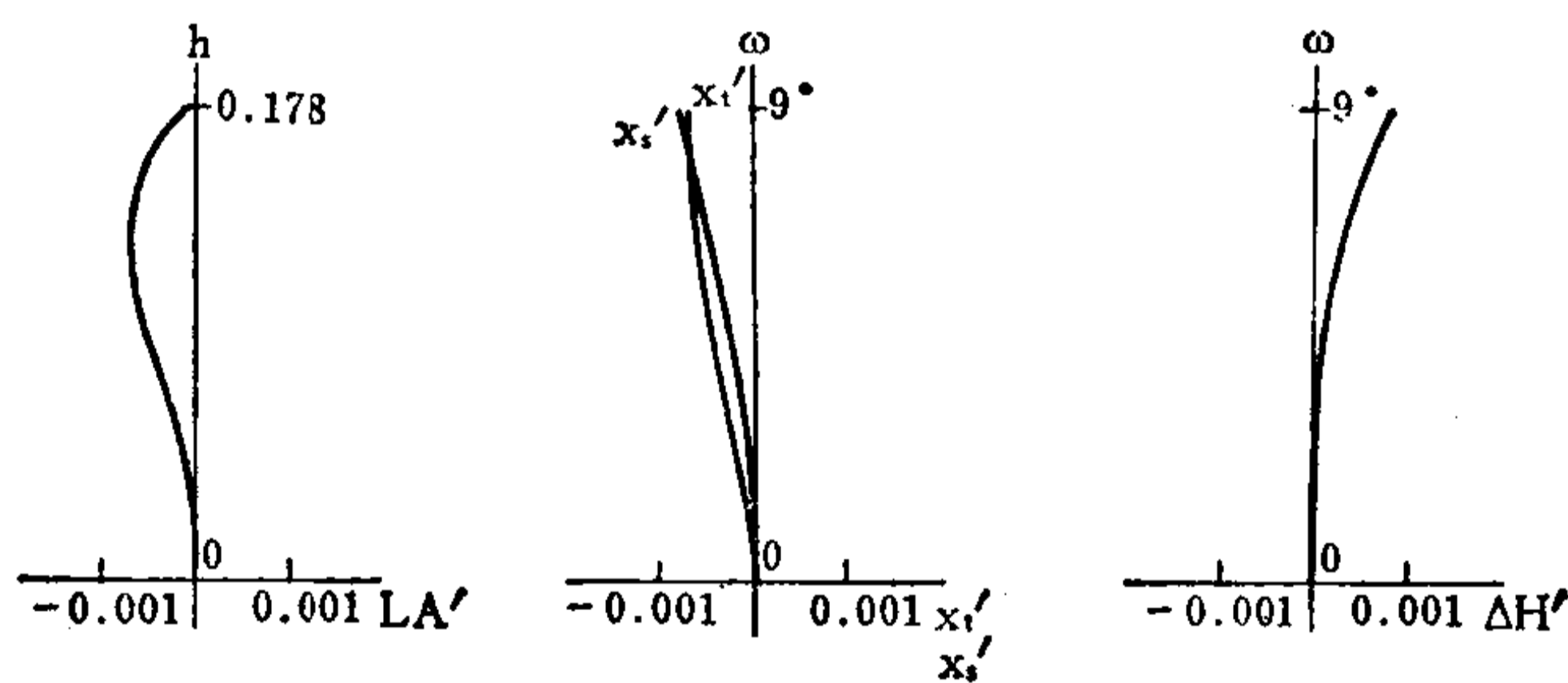

编号: 05-04-044

大孔径长焦距透镜系统

E.F.L=1.0

B.F.L=0.429

FNo. =2.8

F.A. = ±12.03°

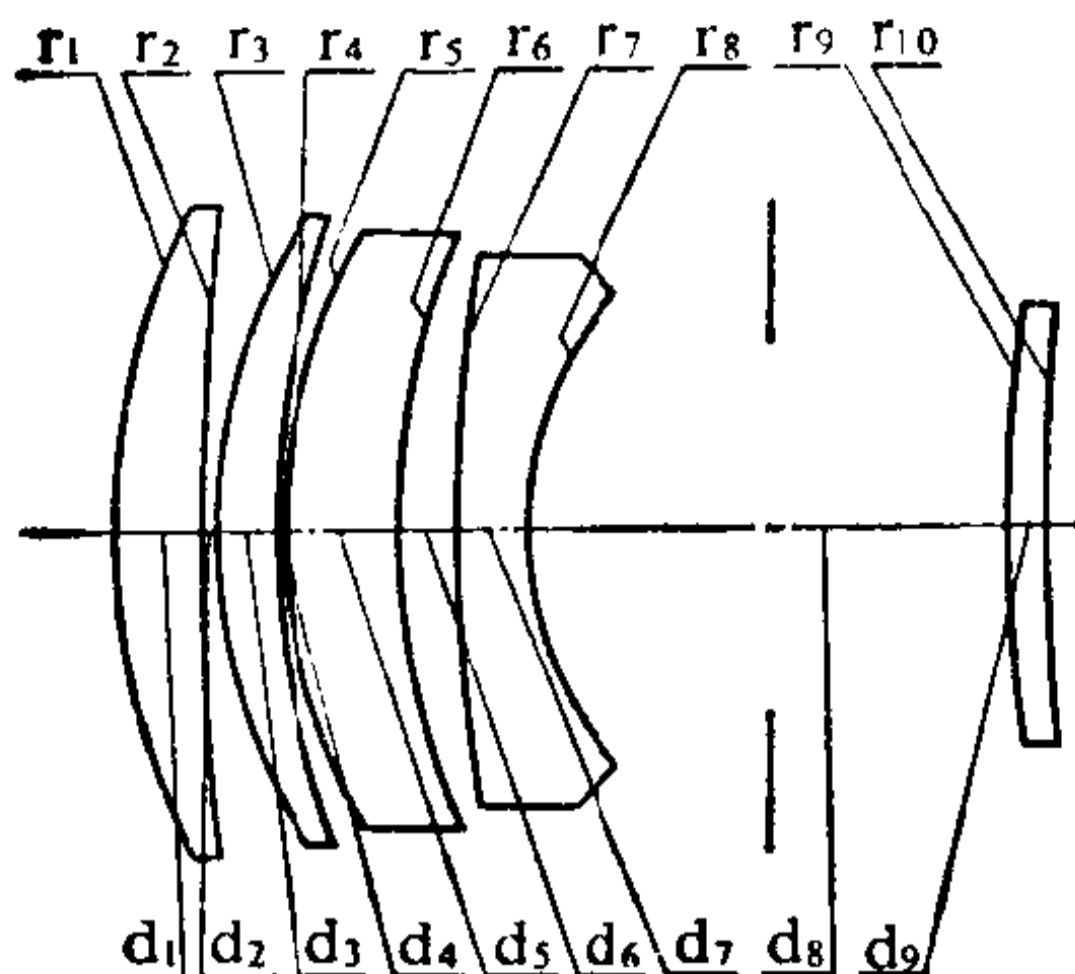

序号	r	d	n	v	序号	r	d	n	v
1	0.4011	0.0472	1.58913	61.11	6	0.4159	0.0261		
2	2.3231	0.0042			7	0.8450	0.0389	1.78470	26.22
3	0.3213	0.0336	1.56873	63.16	8	0.1960	0.2578*		
4	0.5016	0.0025			9	0.6486	0.0255	1.78470	26.22
5	0.3406	0.0639	1.70154	41.10	10	1.7995			

$0.2578^* = 0.1300 + 0.1278$

	ΣS_1	ΣS_2	ΣS_3	ΣS_4	ΣS_5	HI	QP(1 ω)
	-0.000175	-0.000093	0.000090	-0.000137	0.001077	0.213	1.1%
h 或 ω %	LA'	$\Delta H'$	x'_t	x'_s	$x'_t - x'_s$	K'_{T1}	$K'_{10.7}$
100	-0.000045	0.002425	-0.001137	-0.000264	-0.000873	0.002505	0.000869
70	-0.000744	0.000989	0.000377	-0.000284	0.000661	0.000509	0.000107

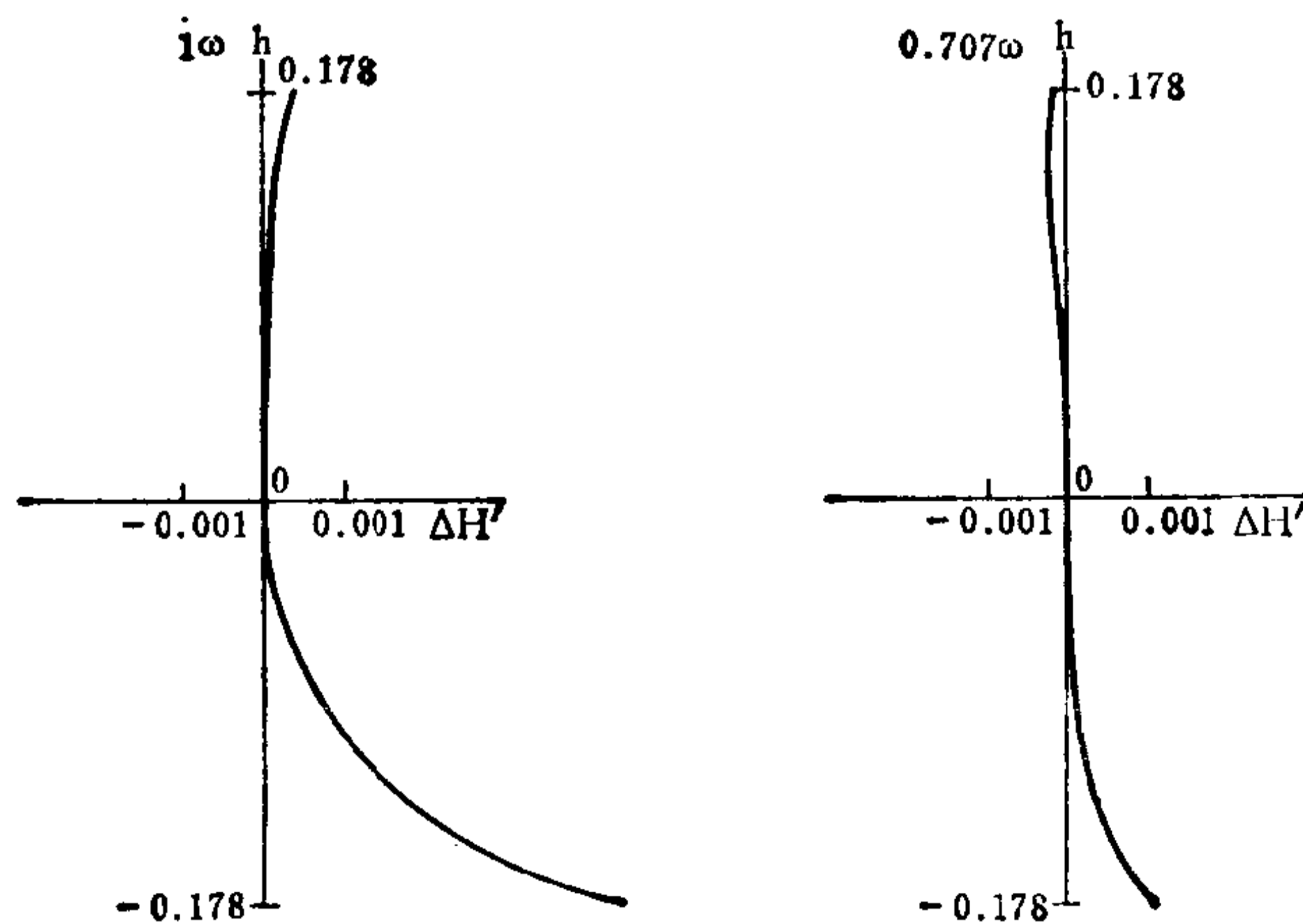
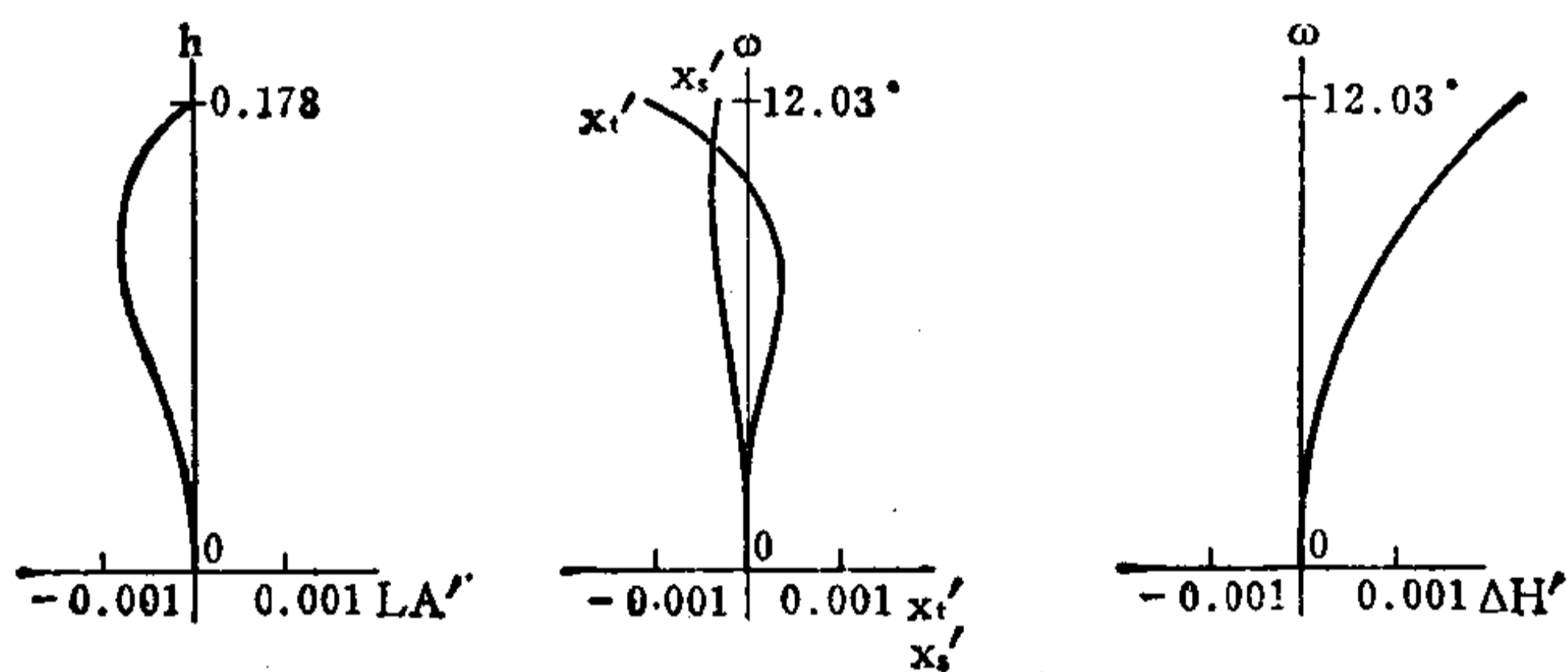

编号: 05-04-045

五片型重显物镜

E. F. L = 91

B. F. L = 79.97

FNo. = 5.6

F. A. = $\pm 20''$

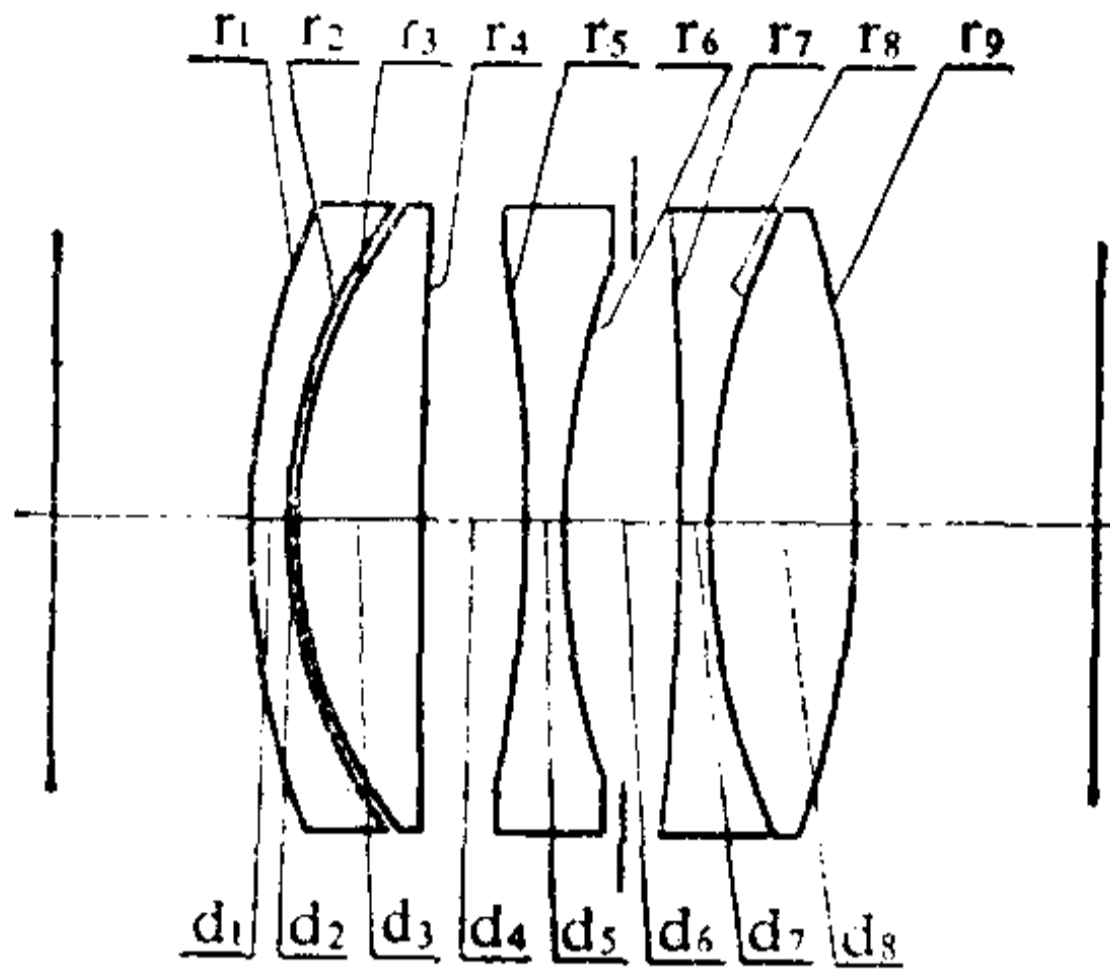

序号	r	d	n	v	序号	r	d	n	v
1	32.246	1.36	1.59551	39.2	6	29.478	3.90*		
2	19.257	0.15			7	-144.764	1.25	1.54869	45.4
3	19.257	4.49	1.65844	50.8	8	27.948	5.15	1.65844	50.8
4	1837.150	3.75			9	-36.259			
5	-48.439	1.47	1.57845	41.7					

3.90* = 2.00 + 1.90

	ΣS_1	ΣS_2	ΣS_3	ΣS_4	ΣS_5	HI	QP(1 ω)
	-0.01398	-0.00721	-0.00148	-0.02039	0.02197	33.2	0.4%
h 或 ω %	LA'	$\Delta H'$	x'_i	x'_s	$x'_i - x'_s$	K'_{T1}	$K'_{T0.7}$
100	-0.6542	0.1358	-0.3712	-0.7206	0.3494	-0.3132	-0.1308
70	-0.3871	0.0466	-0.5207	-0.5568	0.0361	-0.1699	-0.0704

注: 1. M = 1*;

2. 以上象差值是按 $l = -\infty$ 计算的。

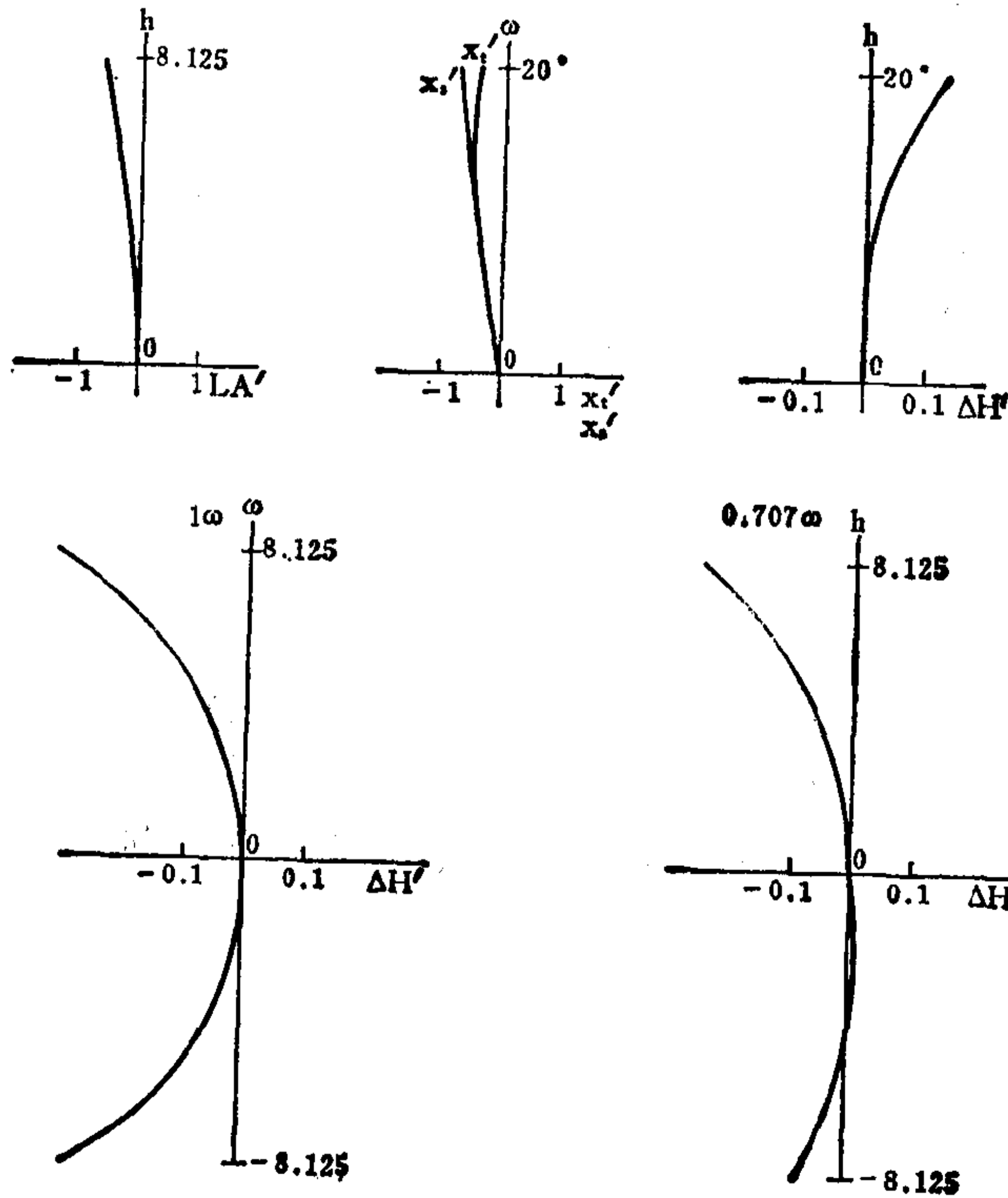

编号: 05-04-046

五片型重显物镜

E.F.L = 100.3

B.F.L = 90.67

FNo. = 5.6

F.A. = ±20°**

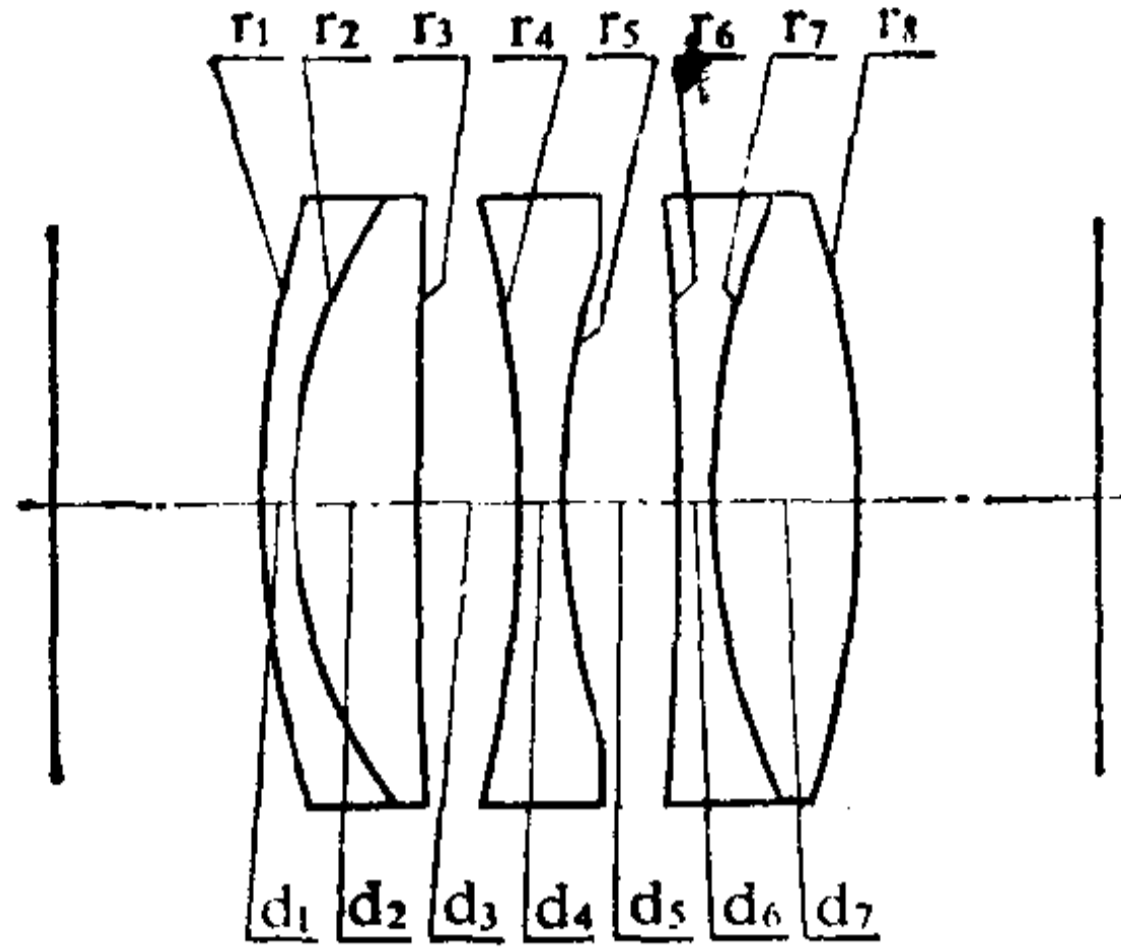

序号	r	d	n	v	序号	r	d	n	v
1	33.769	1.10	1.59551	39.2	5	29.478	4.23		
2	19.080	4.41	1.65844	50.8	6	-144.764	1.25	1.54869	45.4
3	1014.670	3.68*			7	27.948	5.15	1.65844	50.8
4	-48.439	1.47	1.57845	41.7	8	-36.259			

3.68* = 2.13 + 1.55

	ΣS_1	ΣS_2	ΣS_3	ΣS_4	ΣS_5	HI	QP(1 ω)
	-0.00605	-0.00561	0.00035	-0.01808	-0.00471	36.6	-0.06%
h 或 ω %	LA'	$\Delta H'$	x'_t	x'_s	$x'_t - x'_s$	K'_{T1}	$K'_{T0.7}$
100	0.1981	-0.0224	-0.2553	-0.4114	0.1561	-0.2264	-0.1008
70	-0.0629	-0.0088	-0.3307	-0.4107	0.0800	-0.1063	-0.0500

注: 1. M = 1*

2. 以上象差值是按 $l = -\infty$ 计算的。

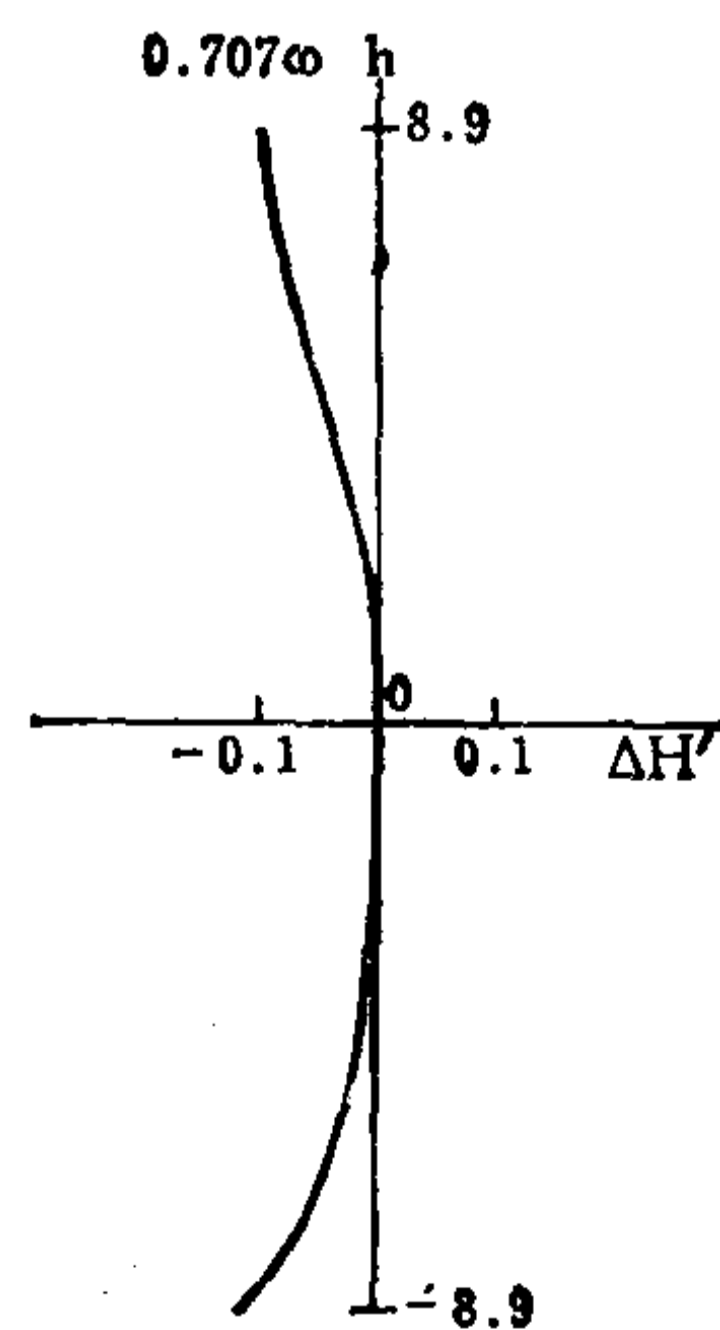
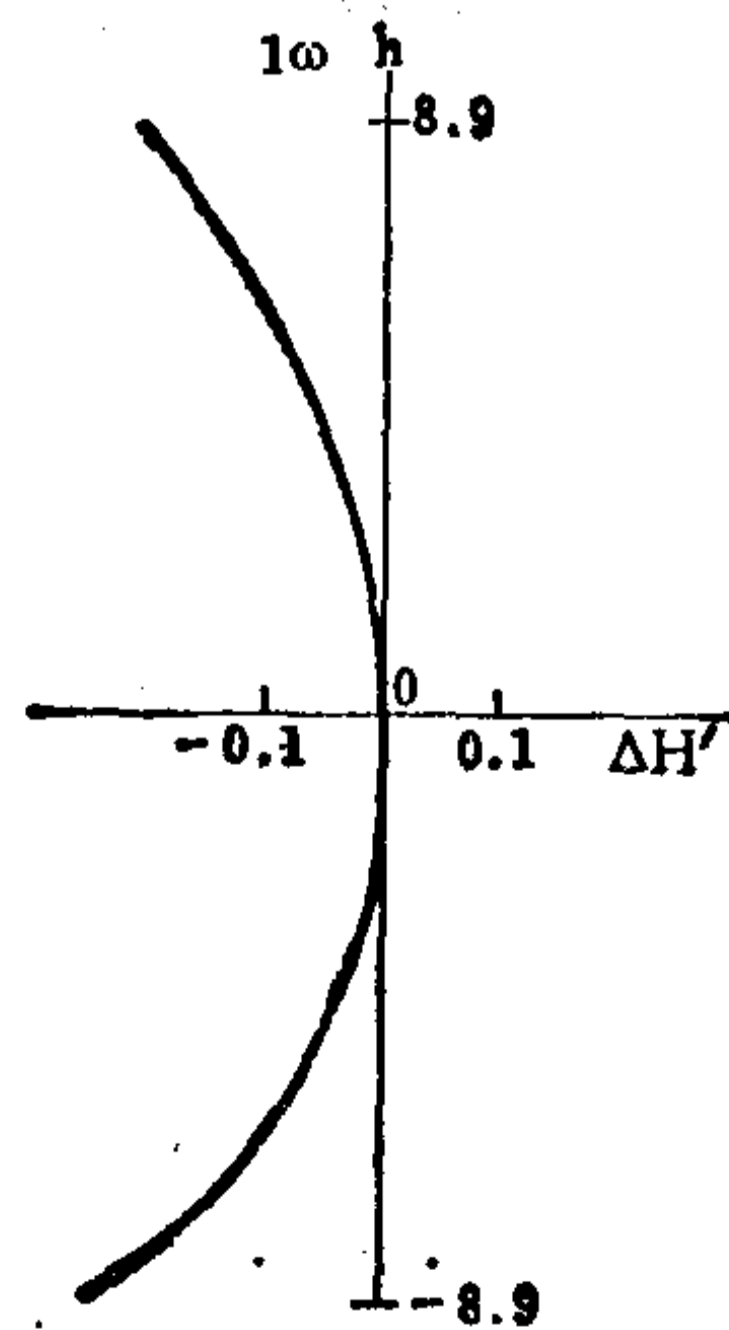
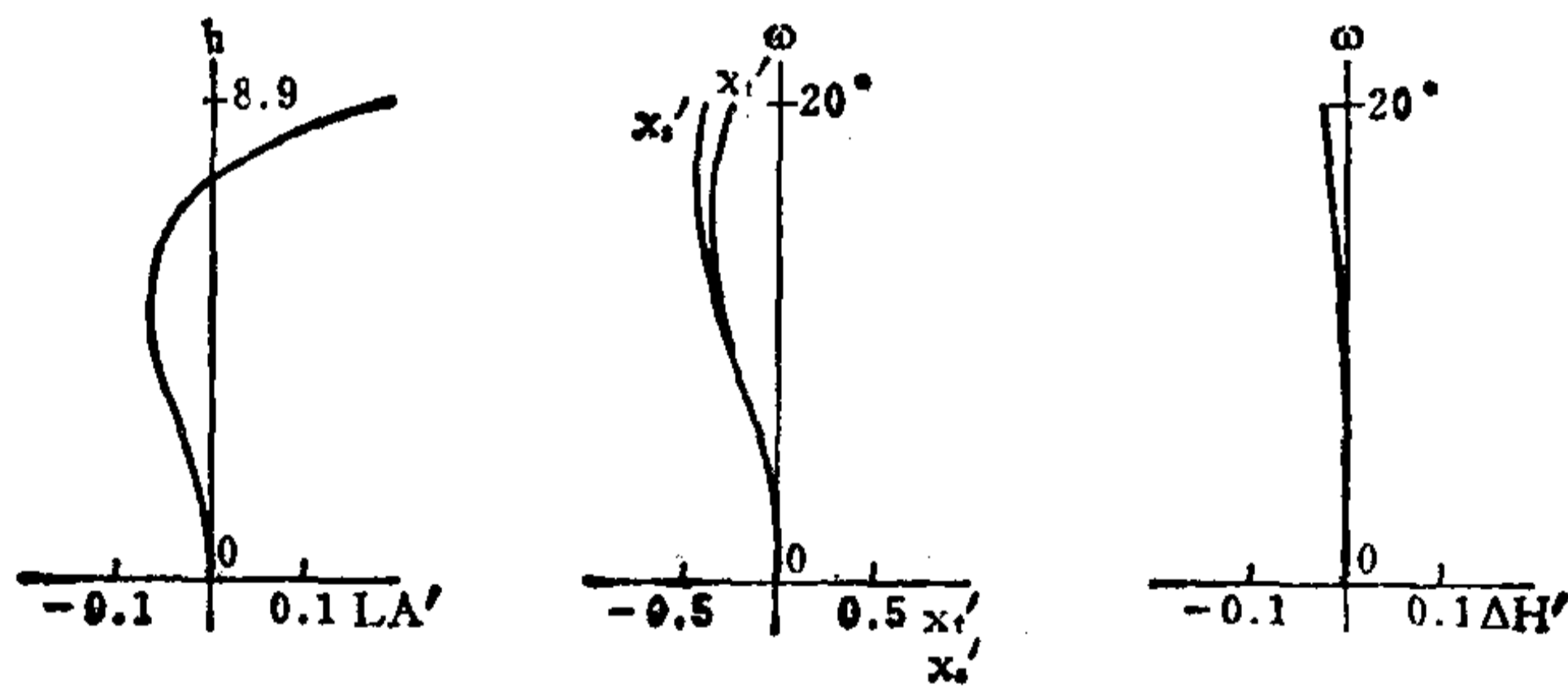

编号: 05-04-047

低折射率玻璃材料的三片型工业电视镜头

E.F.L=103.3

B.F.L=0

FNo.=4

F.A.=±4.6°

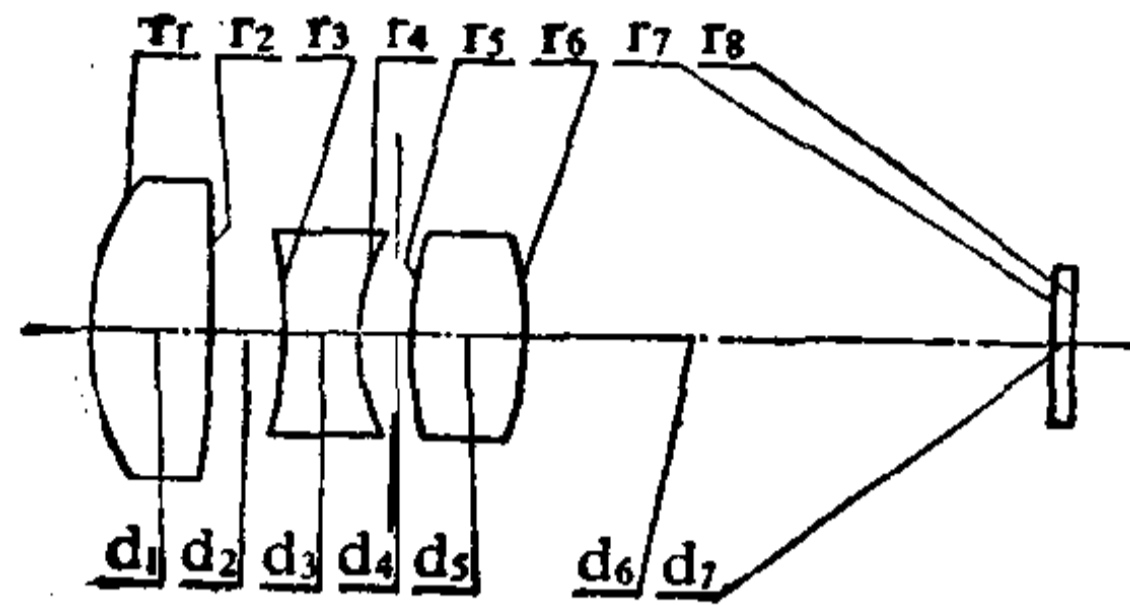

序号	r	d	n _D	v _D	序号	r	d	n _D	v _D
1	32.727	15.000	1.5147	60.6	5	54.971	14.000	1.5163	64.1
2	-203.125	8.800			6	-39.447	66.394		
3	-46.696	10.000	1.6199	36.3	7	∞	2.600	1.5163	64.1
4	28.080	6.800*			8	∞			

6.800* = 4.000 + 2.800

注: 第四片为靶面玻璃。

	ΣS ₁	ΣS ₂	ΣS ₃	ΣS ₄	ΣS ₅	HI	QP(1ω)
	-0.04120	0.00433	0.00492	-0.00536	-0.00018	8.3	-0.007%
h 或 ω %	LA'	ΔH'	x' _i	x' _s	x' _i - x' _s	K _{T1}	K _{T0.7}
100	-0.8459	-0.0006	0.2964	-0.0131	0.3095	-0.02958	0.00704
70	-0.5610	-0.0002	0.1503	-0.0067	0.1570	-0.01566	0.00698

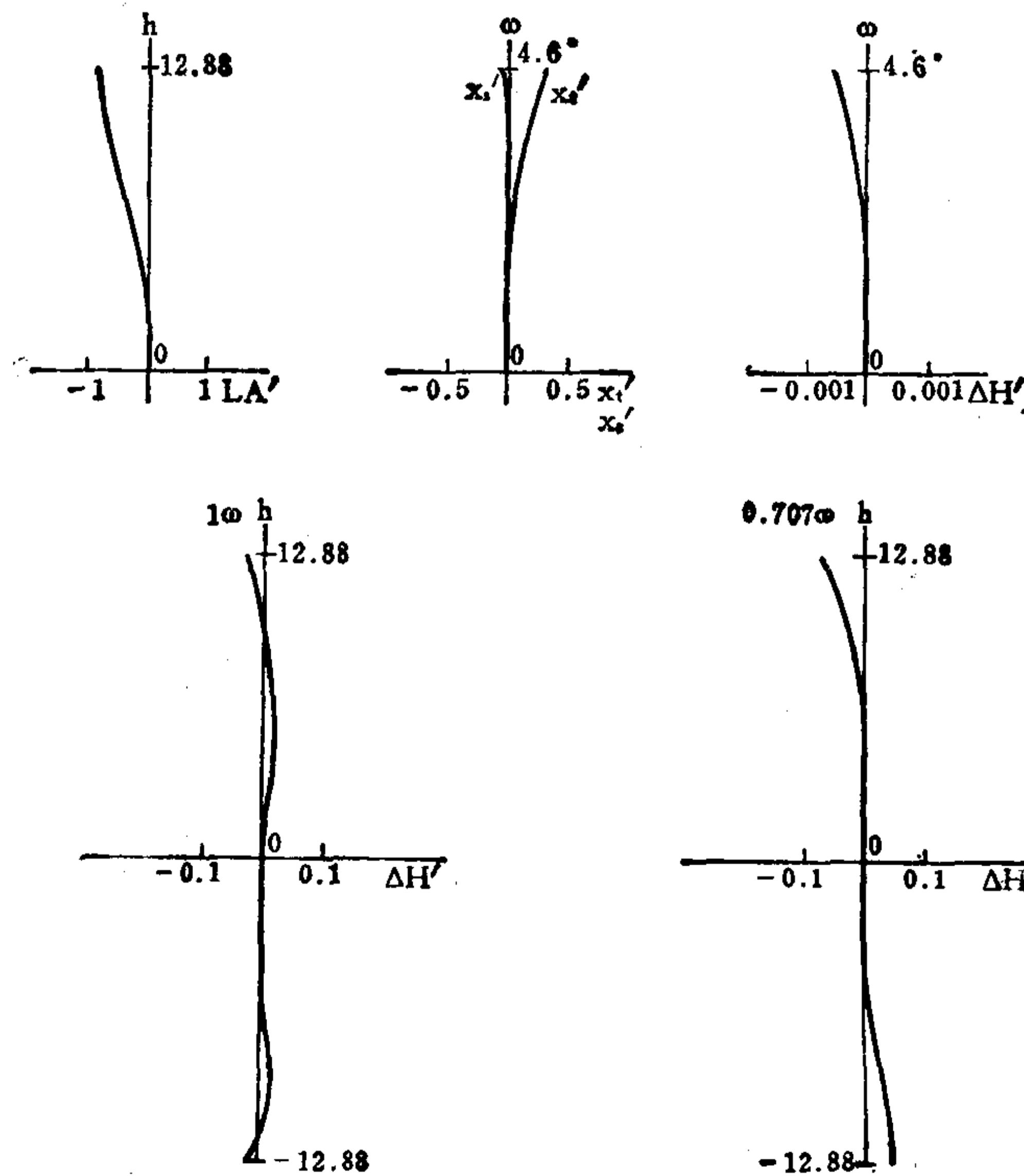

编号: 05-04-048

广角袖珍投影透镜系统

E.F.L=99.6

B.F.L=28.5

FN₀. = 4

F.A. = ±45°

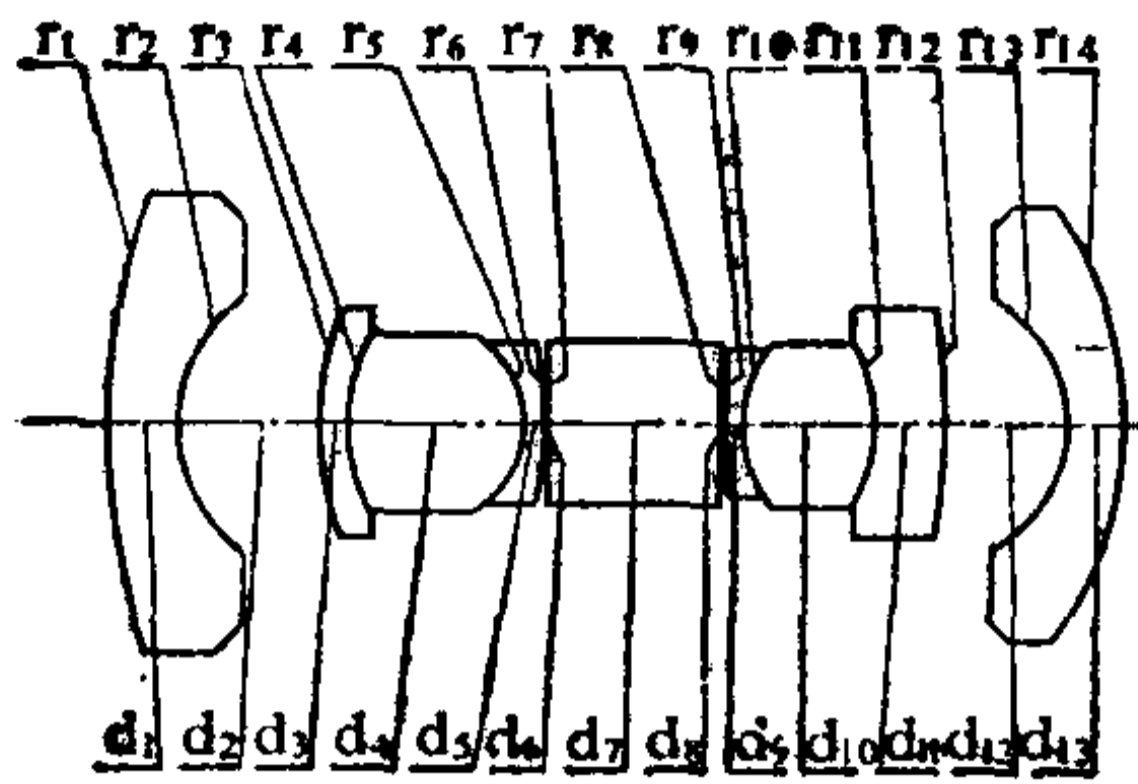

序号	r	d	n _D	v	序号	r	d	n _D	v
1	190.380	17.54	1.522	59.5	8	∞	0.07		
2	41.627	36.48			9	660.813	4.21	1.523	51.5
3	80.935	7.01	1.788	50.5	10	35.054	35.85	1.658	50.5
4	44.987	45.88	1.592	58.5	11	-42.946	18.24	1.784	26.5
5	-37.194	4.91	1.523	51.5	12	-157.627	30.87		
6	-103.752	0.07			13	-37.088	14.03	1.541	47.5
7	∞	44.55*	1.800	50.0	14	-103.401			

44.55* = 22.33 + 22.22

注: 光栏为等效光栏。

	ΣS ₁	ΣS ₂	ΣS ₃	ΣS ₄	ΣS ₅	HI	QP(1ω)
	-0.0228	-0.0112	-0.0425	0.0529	0.0316	99.5	0.3%
h 或 ω%	LA'	ΔH'	x _t '	x _s '	x _t ' - x _s '	K _{T1}	K _{T0.7}
100	-0.936	0.305	2.119	-1.019	3.138	1.9214	0.0128
70	-0.405	0.117	0.136	0.033	0.103	0.1217	-0.0136

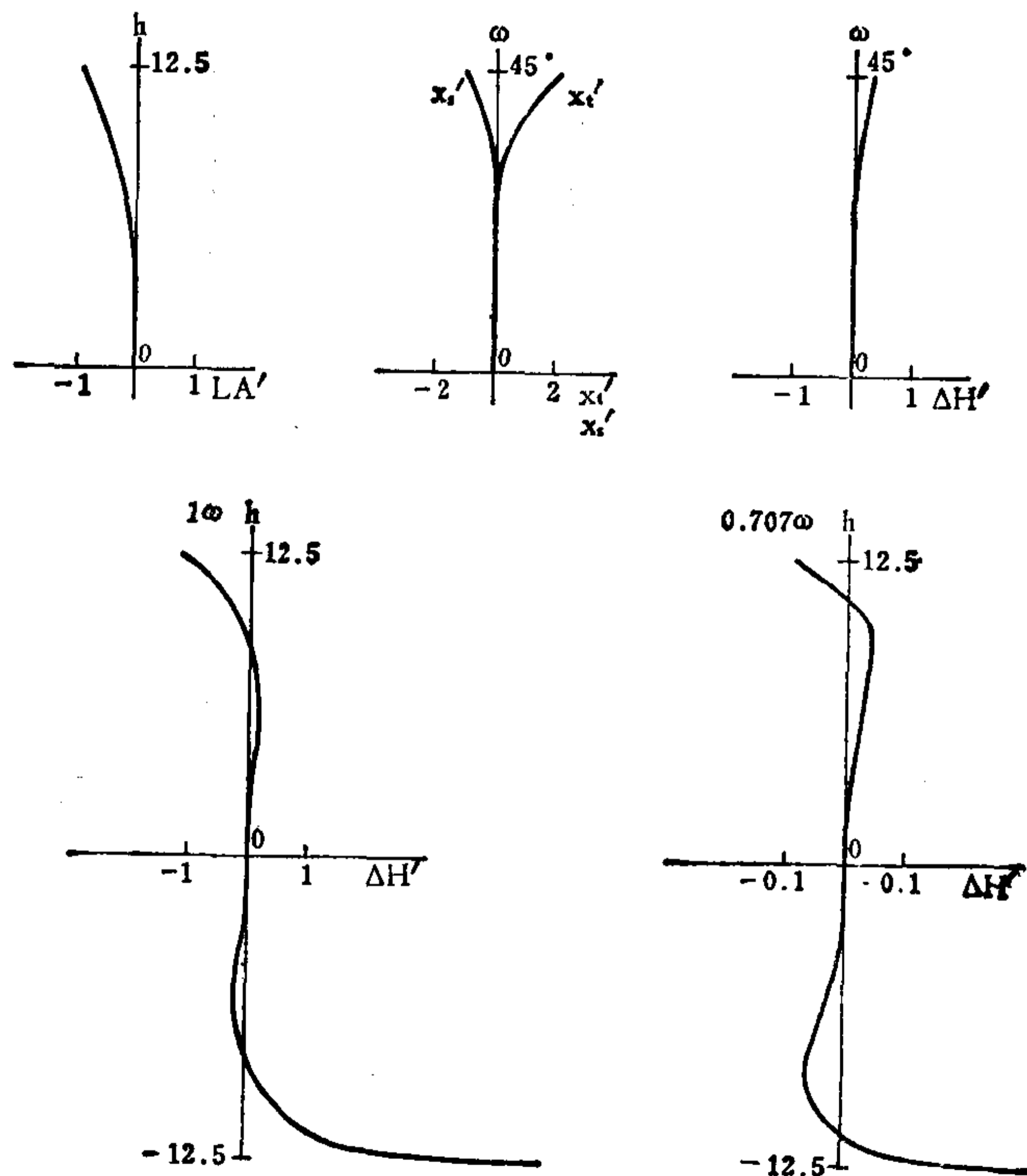

编号: 05-04-049

低折射率玻璃材料的四片型工业电视镜头

E.F.L=51.11

B.F.L=0

FNo.=1.75

F.A.=±9.2°

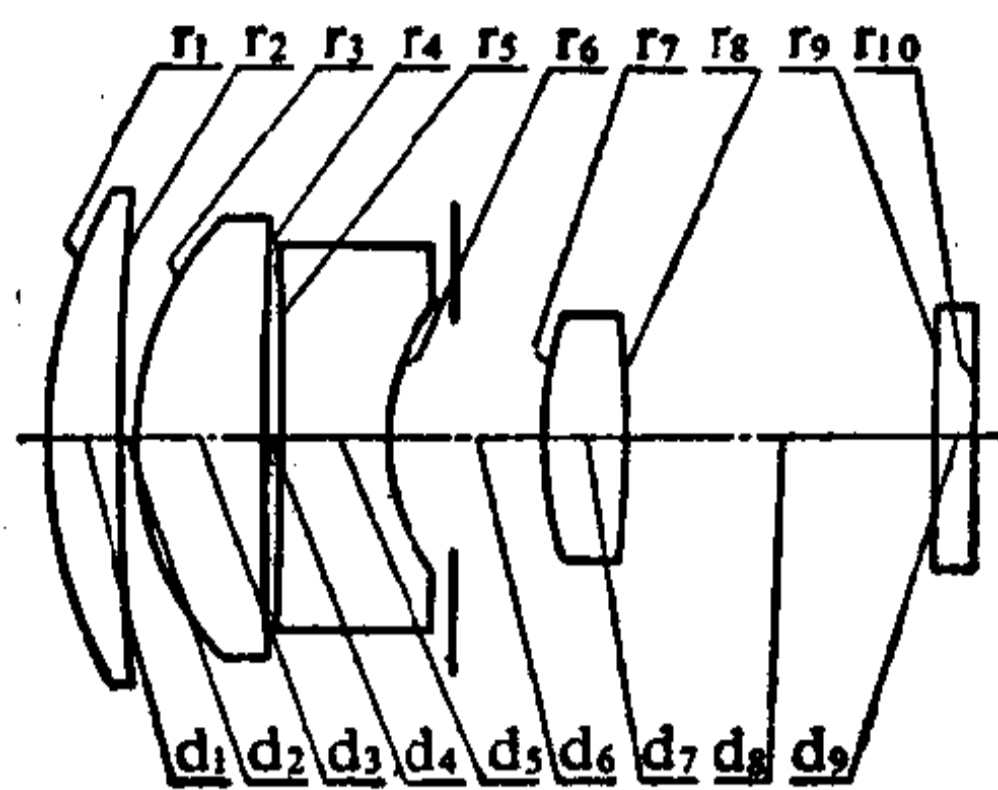

序号	r	d	n _D	v _D	序号	r	d	n _D	v _D
1	32.707	5.000	1.5163	64.1	6	13.614	10.000*		
2	254.000	0.800			7	26.730	5.000	1.5147	60.6
3	20.720	8.200	1.5163	64.1	8	-74.992	19.996		
4	440.321	1.000			9	∞	2.600	1.5163	64.1
5	-299.200	7.000	1.6725	32.2	10	∞			

10.000* = 4.000 + 6.000

注: 第五片为靶面玻璃。

	ΣS ₁	ΣS ₂	ΣS ₃	ΣS ₄	ΣS ₅	HI	QP(1ω)
	-0.0976	0.0298	0.0061	-0.0600	0.0100	8.24	0.05%
h 或 ω %	LA'	ΔH'	x _t '	x _s '	x _t - x _s '	K _{T1} '	K _{T0.7} '
100	0.1850	0.0045	-0.2875	-0.3161	0.0286	-0.3425	0.0028
70	-0.1536	0.0039	-0.1322	-0.1616	0.0294	-0.1897	0.0073

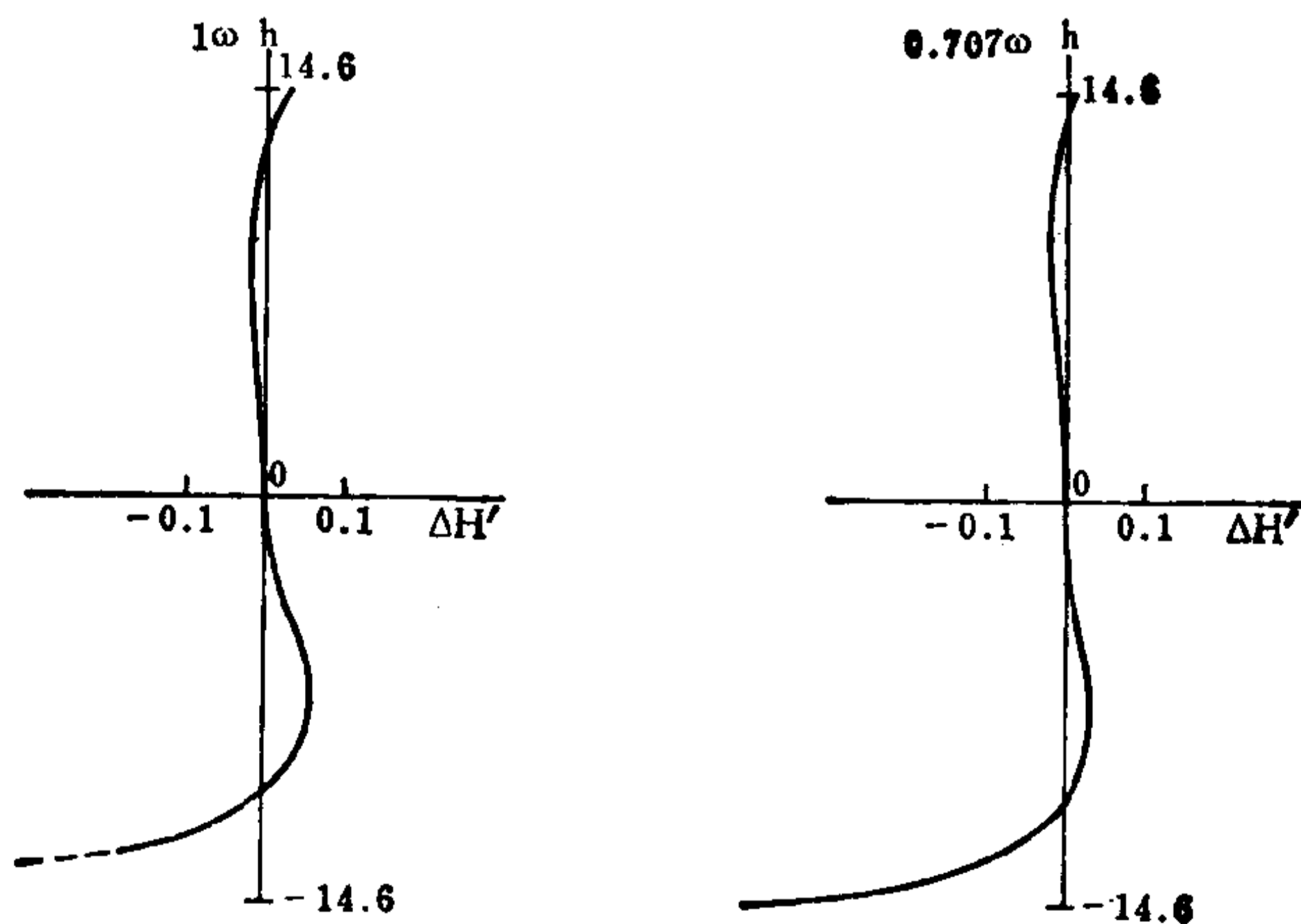
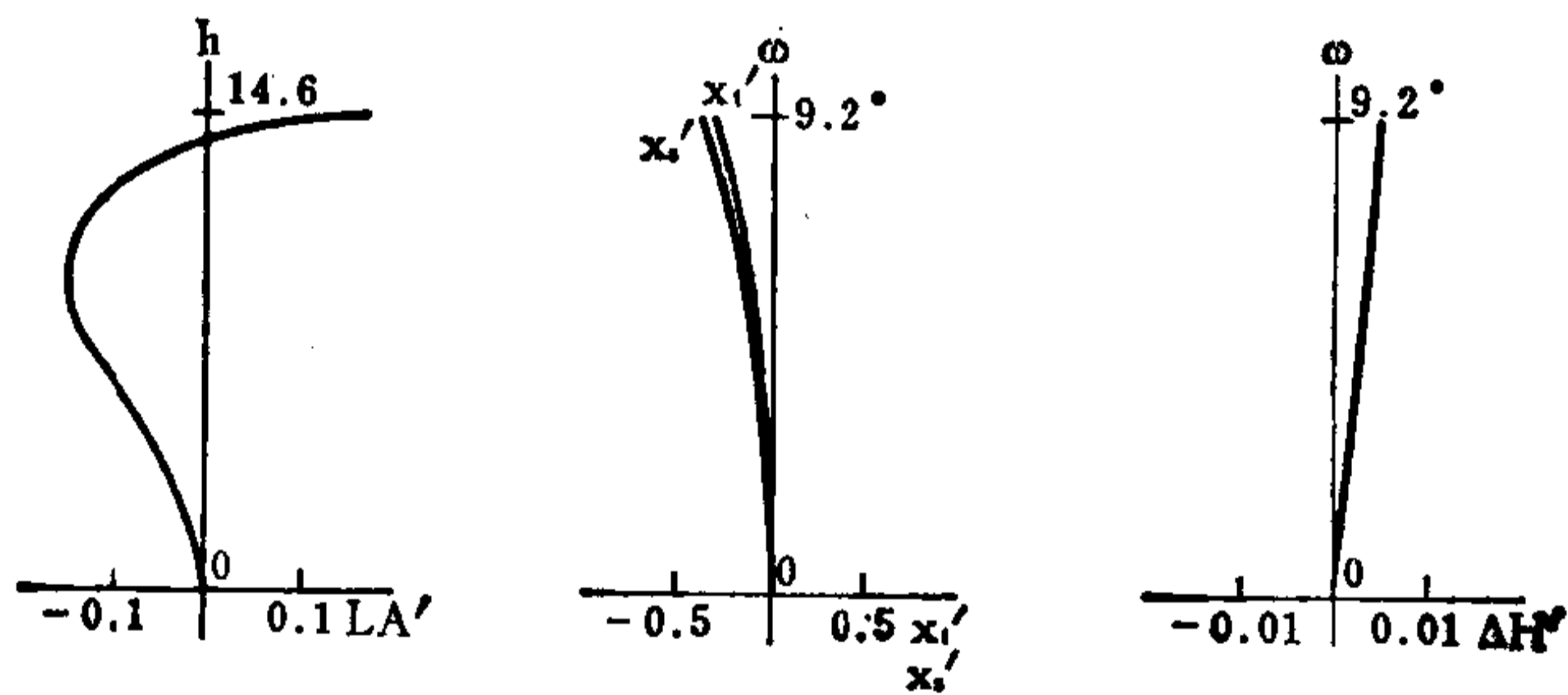

编号: 05-04-050

复印机聚焦透镜系统

E.F.L=1

B.F.L=0.782

FNo.=4

F.A. = ±30° **

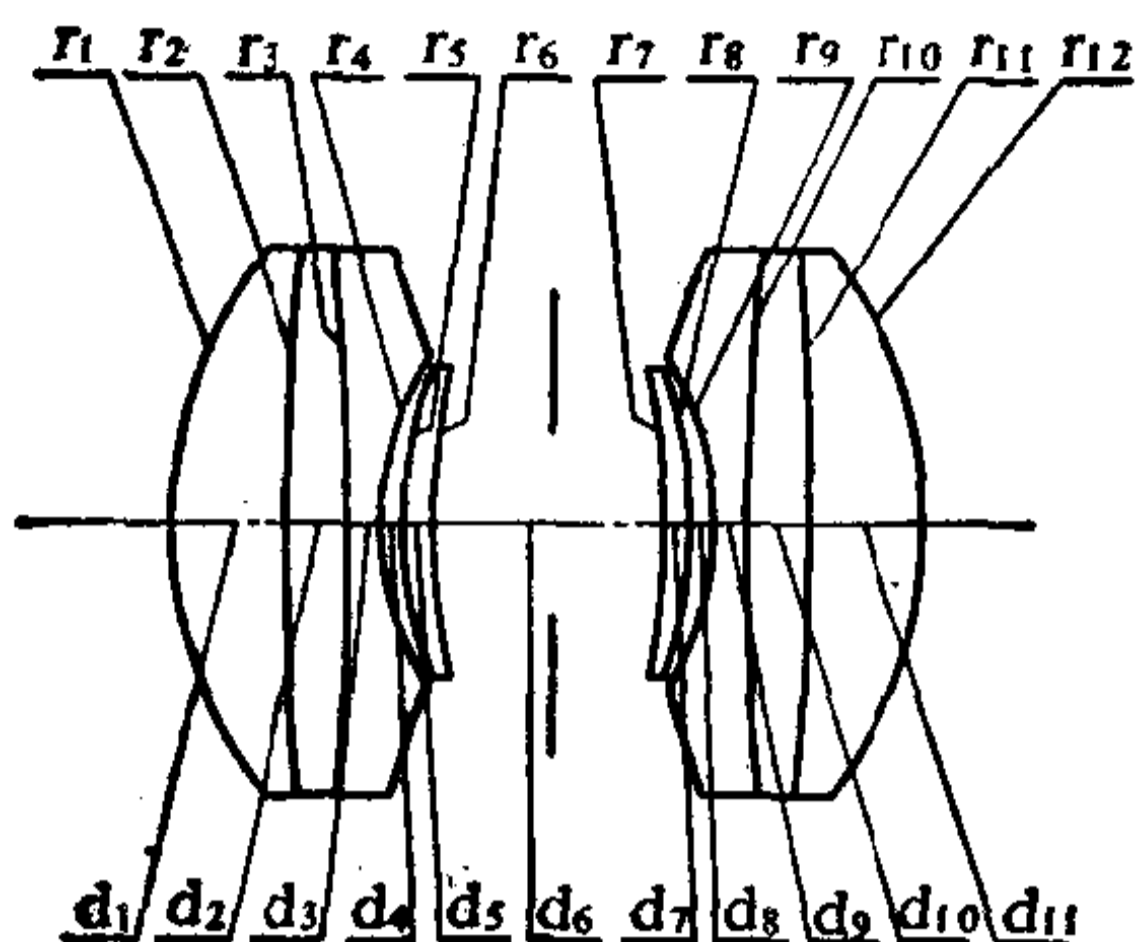

序号	r	d	n	v	序号	r	d	n	v
1	0.23987	0.06282	1.60311	60.5	7	-0.40209	0.01571	1.56873	63.1
2	1.72775	0.03141	1.60562	43.7	8	-0.25084	0.01178		
3	-1.41361	0.01728	1.54814	45.7	9	-0.17192	0.01728	1.54814	45.7
4	0.17192	0.01178			10	1.41361	0.03141	1.60562	43.7
5	0.25084	0.01571	1.56873	63.1	11	-1.72775	0.06282	1.60311	60.5
6	0.40209	0.12375*			12	-0.23987			

$0.123750^* = 0.061875 + 0.061875$

	ΣS_1	ΣS_2	ΣS_3	ΣS_4	ΣS_5	HI	QP(1 ω)
	-0.000414	-0.000444	0.000075	-0.000542	0.001057	0.58	1.24%
h 或 ω %	LA'	$\Delta H'$	x_t	x_s	$x'_t - x'_s$	K'_{T1}	$K'_{T0.7}$
100	0.01500	0.00715	-0.02647	-0.00486	-0.02161	0.000868	-0.001058
70	-0.00098	0.00204	-0.00901	-0.00601	-0.00300	-0.003262	-0.001663

注: 以上象差值是按 $i = -\infty$ 计算的。

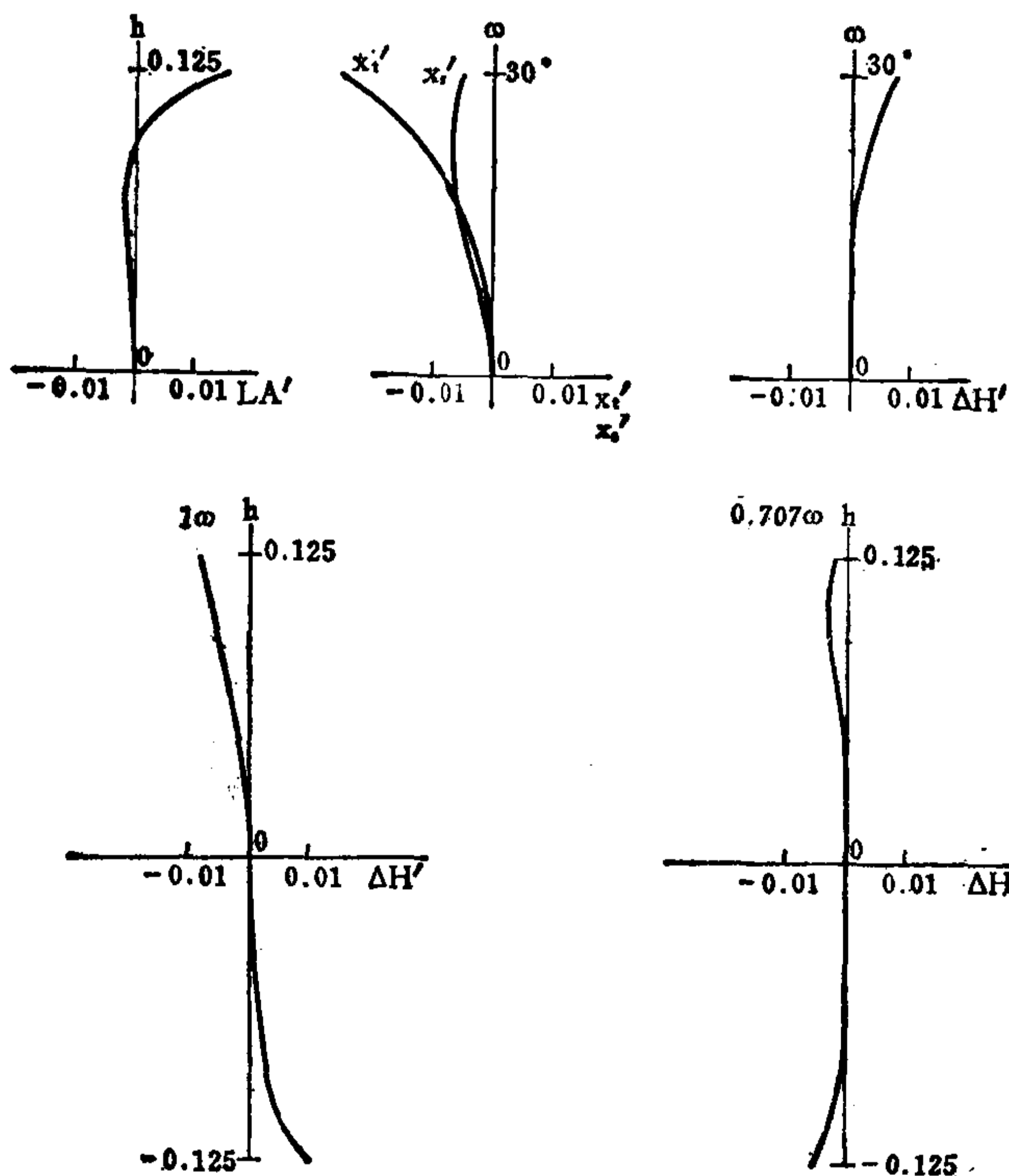

编号: 05-04-051

袖珍四片型物镜

E.F.L=0.999

B.F.L=0.997

FNo.=8

F.A.=±25°**

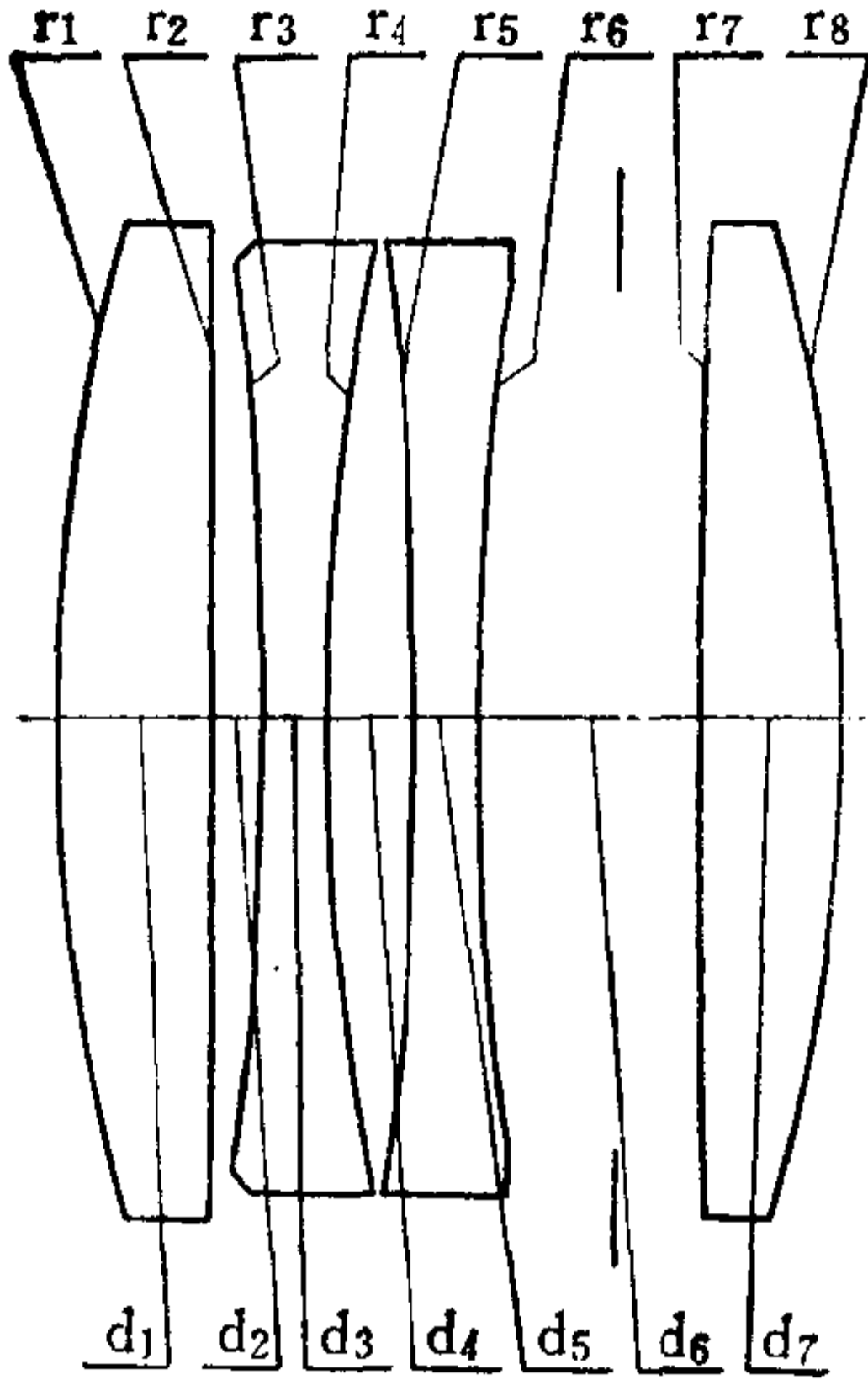

序号	r	d	n _d	v _d
1	0.2182	0.0188	1.678	55.2
2	∞	0.0057~0.0597		
3	-0.5772	0.0079	1.511	60.4
4	0.3267	0.0105		
5	-0.5302	0.0079	1.626	35.7
6	0.3385	0.0270*		
7	1.1217	0.0167	1.651	55.9
8	-0.2664			

0.0270* = 0.0170 + 0.0100

	ΣS ₁	ΣS ₂	ΣS ₃	ΣS ₄	ΣS ₅	HI	QP(1ω)
	0.000045	-0.000020	0.000011	-0.000138	-0.000786	0.466	-2.1%
h 或 ω %	LA'	ΔH'	x' _t	x' _s	x' _t - x' _s	K' _{T1}	K' _{T0.7}
100	0.01513	-0.00976	0.02415	0.00429	0.01986	-0.000433	-0.000158
70	0.00496	-0.00290	0.00208	-0.00379	0.00587	-0.000411	-0.000142

注: 以上象差值是按d₂ = 0.0057计算的。

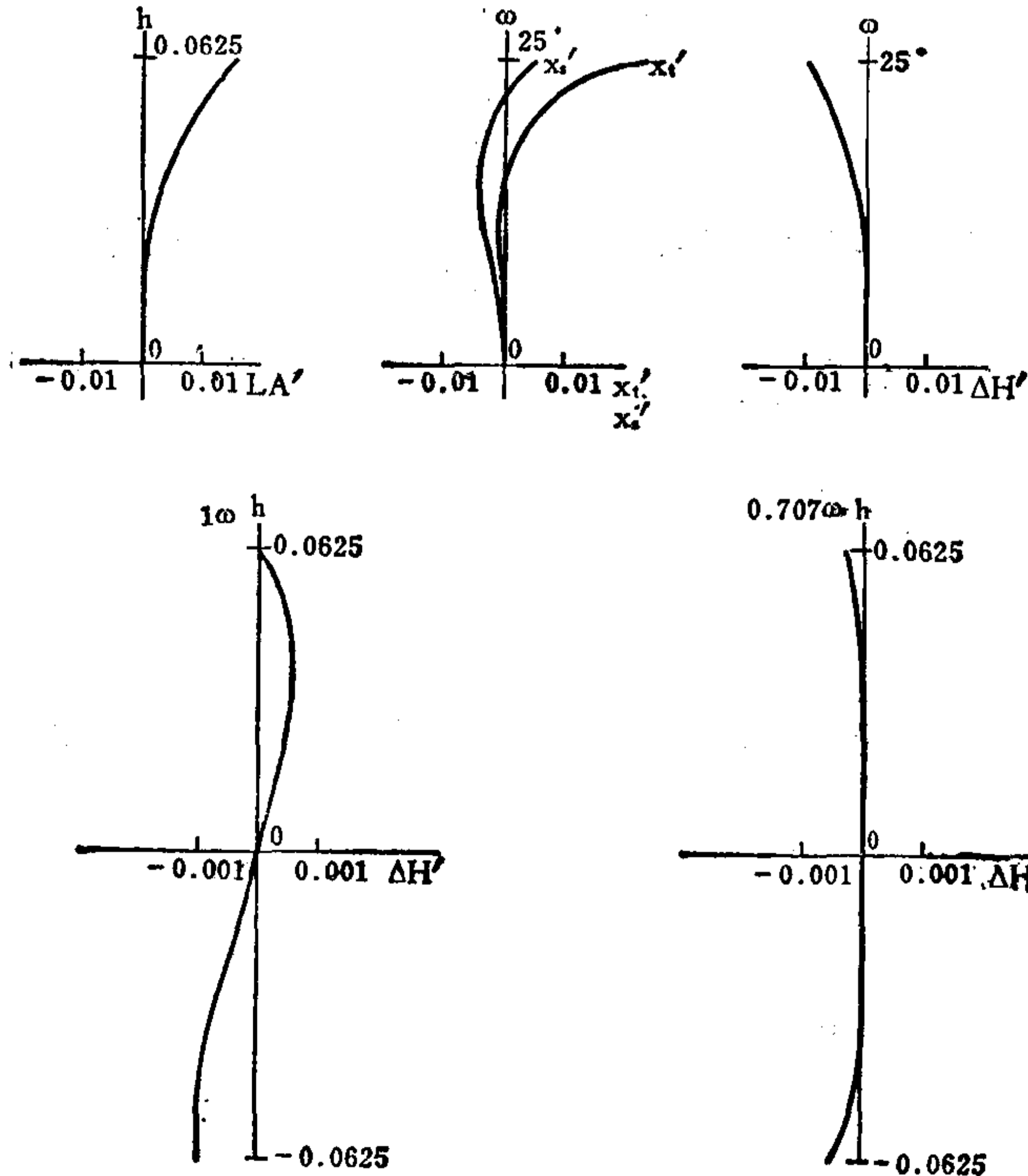

编号: 05-04-052

五组元物镜

E.F.L=100.6

B.F.L=48.2

FNo.=4.02

F.A.=±30°**

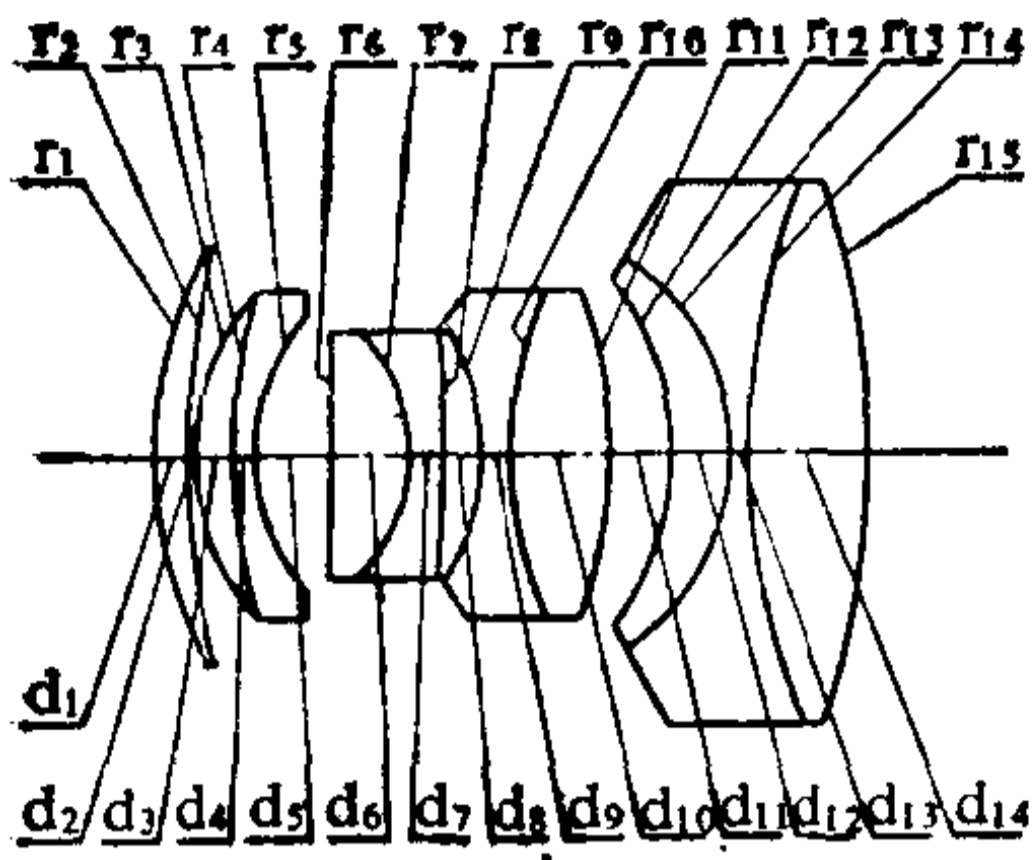

序号	r	d	nd	v	序号	r	d	nd	v
1	37.89	3.18	1.66882	57.4	9	-20.61	3.59	1.61340	44.3
2	68.47	0.10			10	34.77	14.80	1.74400	50.8
3	21.43	4.32	1.69100	54.8	11	-40.67	5.15		
4	51.19	1.63	1.68065	37.4	12	-24.68	4.95	1.69100	54.7
5	18.29	6.65*			13	-20.14	1.67	1.53113	62.2
6	-2070.00	6.20	1.59920	45.1	14	60.67	10.20	1.46450	65.8
7	-14.55	2.90	1.59197	48.5	15	-72.66			
8	-180.00	2.97	1.47069	67.3					

6.65* = 6.55 + 0.10

	ΣS_1	ΣS_2	ΣS_3	ΣS_4	ΣS_5	HI	QP(1 ω)
	-0.0113	0.0034	0.0142	-0.0456	-0.0109	58	-0.240%
h 或 ω %	LA'	$\Delta H'$	x_t	x'_s	$x'_i - x'_s$	K'_{T1}	$K'_{T0.7}$
100	-0.0058	-0.1398	-0.0605	0.6627	-0.7232	-0.29214	-0.12961
70	-0.0861	-0.0420	0.0525	-0.1526	0.2051	0.04512	0.01170

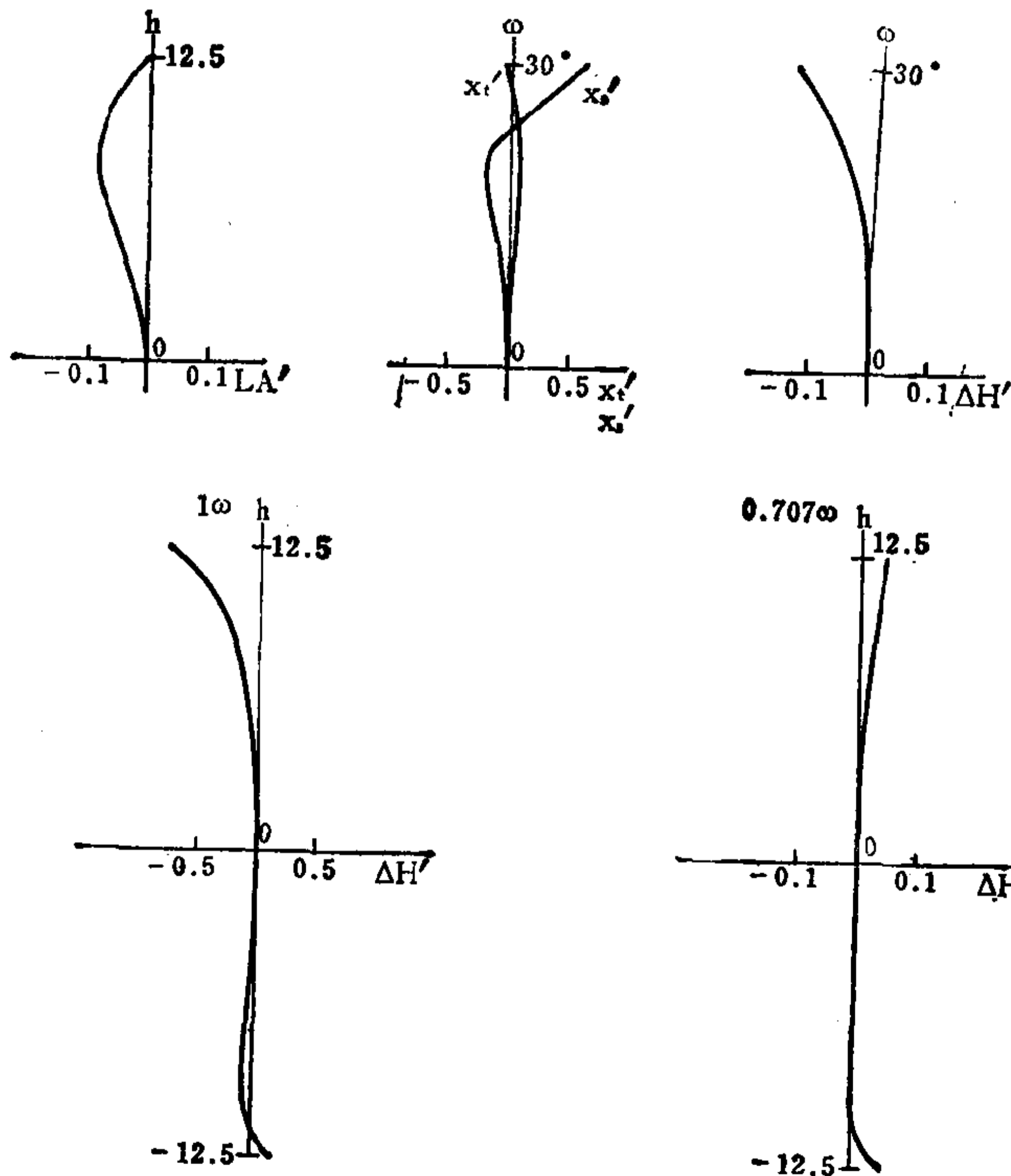

编号: 05-04-053

三片型工业电视镜头

E.F.L=50.56

B.F.L=0

FNo.=2.81

F.A.=±9.2°

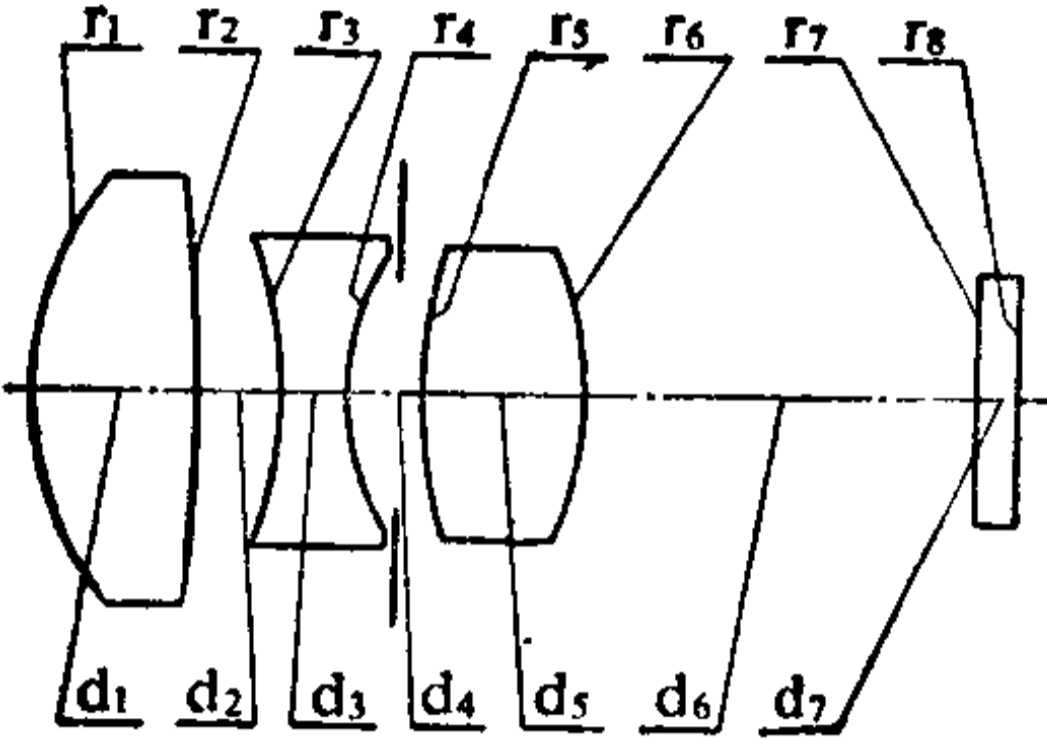

序号	r	d	n _D	v _D	序号	r	d	n _D	v _D
1	22.540	10.570	1.6130	60.6	5	32.169	10.570	1.5891	61.2
2	-121.955	5.410			6	-23.501	29.497		
3	-27.800	4.300	1.6475	33.9	7	∞	2.600	1.5163	64.1
4	16.700	4.750*			8	∞			

4.750* = 3.000 + 1.750

注: 第四片为靶面玻璃。

	ΣS ₁	ΣS ₂	ΣS ₃	ΣS ₄	ΣS ₅	HI	QP(1ω)
	-0.0513	0.0035	0.0019	-0.0197	0.0045	8.16	0.23%
h 或 ω %	LA'	ΔH'	x _i	x _s	x _i - x _s	K _{T1}	K _{T0.7}
100	-0.5358	0.0189	-0.4292	-0.3015	-0.1277	-0.03518	-0.00392
70	-0.3477	0.0053	-0.1553	-0.1452	-0.0101	-0.05306	-0.00728

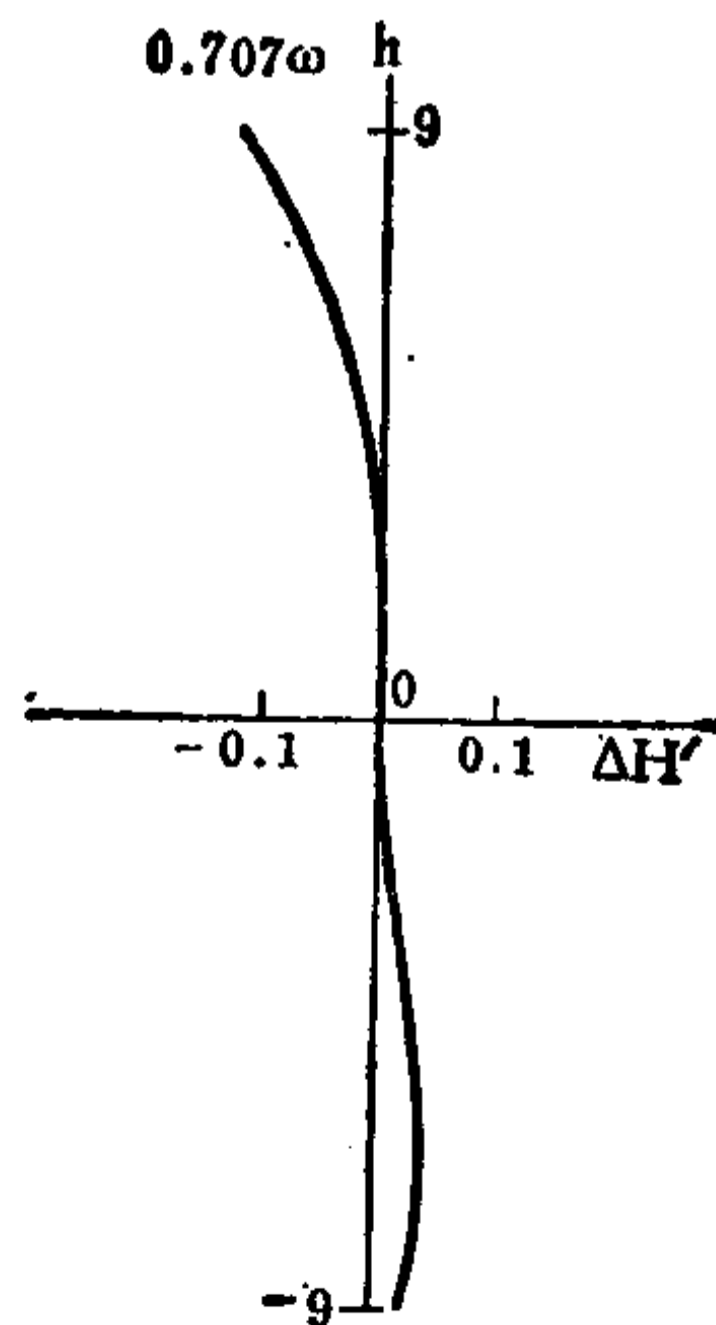
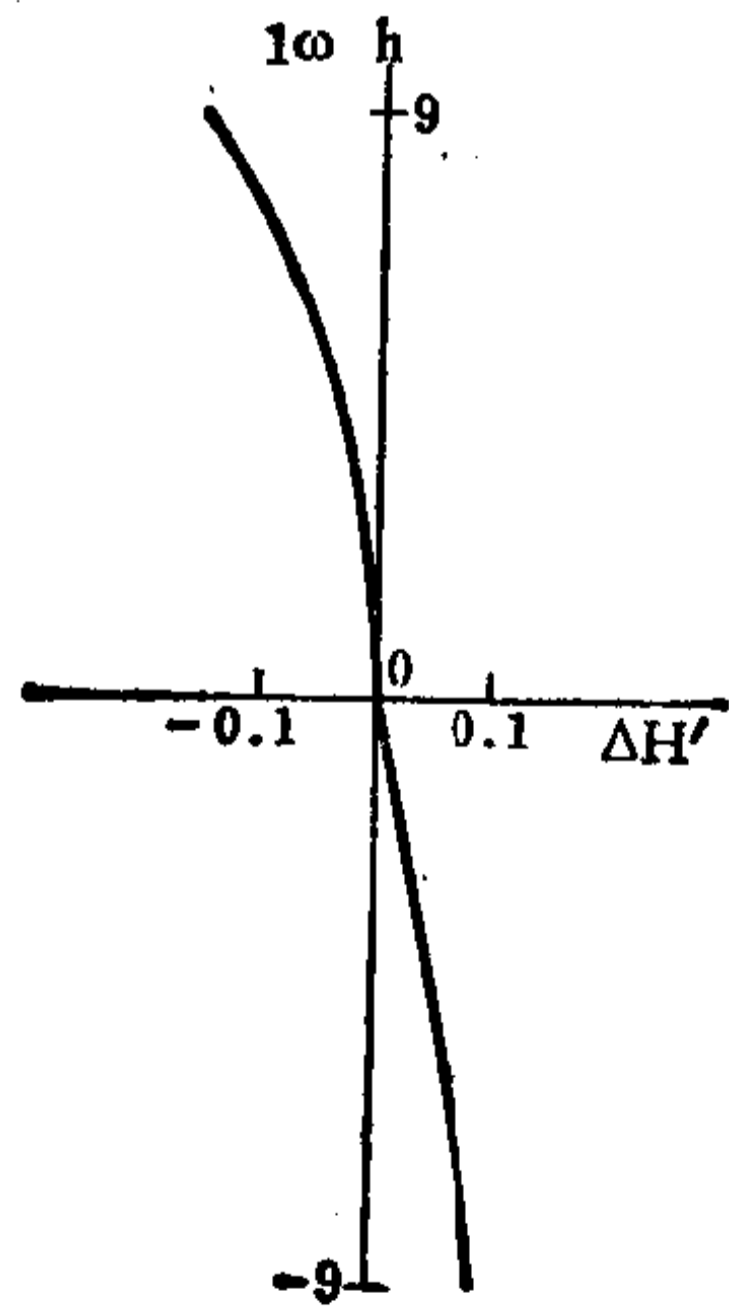
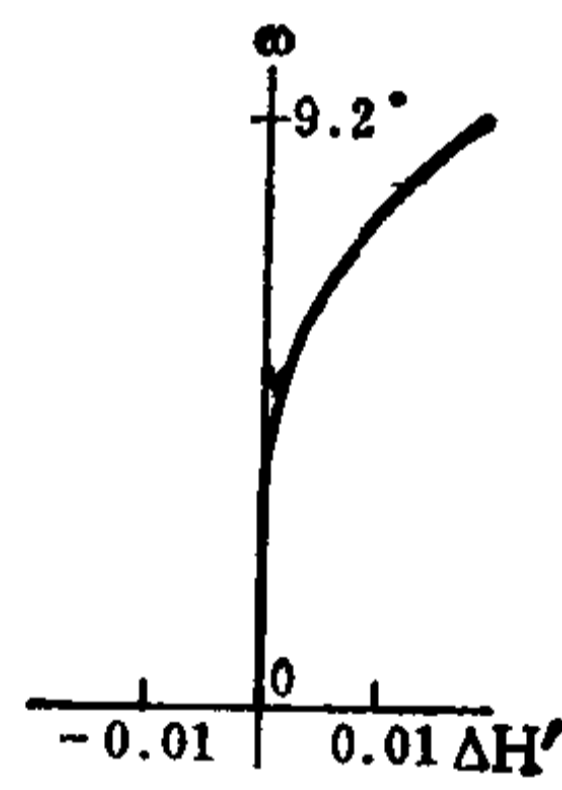
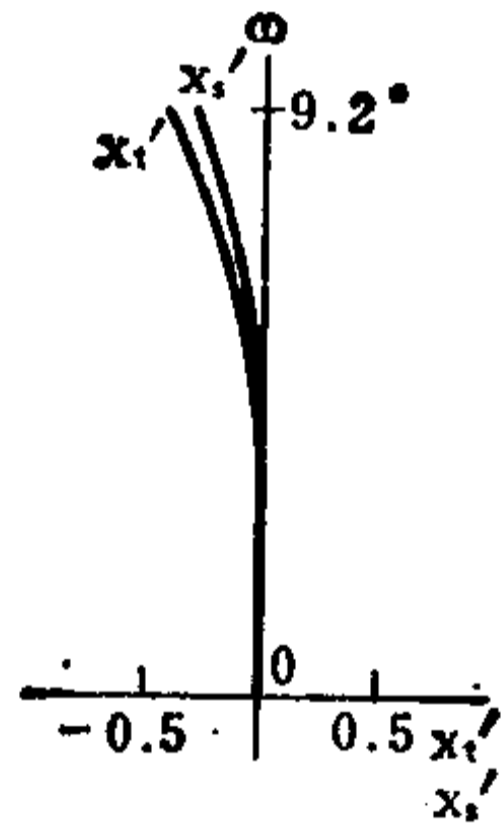
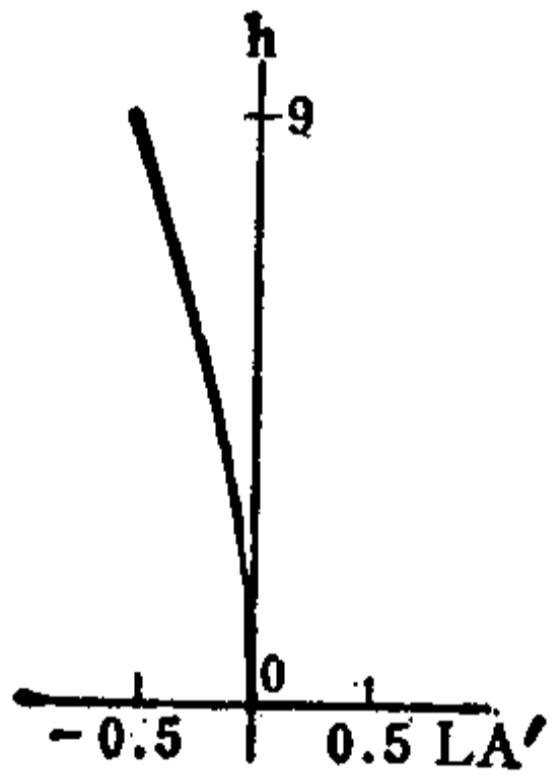

编号: 05-04-054

逆聚焦型广角摄影物镜

E.F.L = 100.05

B.F.L = 111.43

FNo. = 2.8

F.A. = ±31.5°

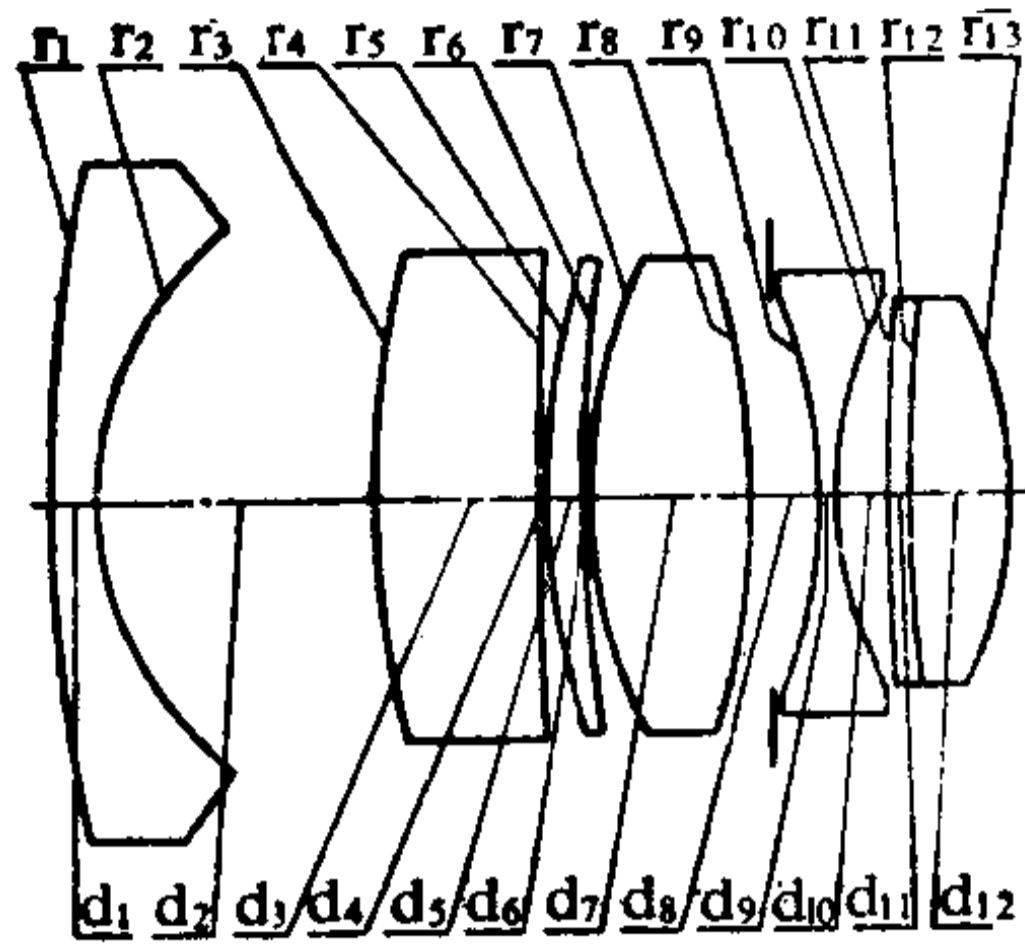

序号	r	d	n_d	v	序号	r	d	n_d	v
1	252.639	5.111	1.56883	56.0	8	-107.814	8.361*		
2	45.028	35.778			9	-69.322	2.500	1.67270	32.1
3	128.350	20.833	1.61772	49.8	10	52.258	6.944		
4	1299.453	0.444			11	740.983	2.500	1.58114	40.7
5	96.058	5.556	1.60342	38.0	12	218.769	12.778	1.65160	58.5
6	225.911	0.417			13	-56.236			
7	71.833	19.917	1.62041	60.2					

$8.361^* = 3.333 + 5.028$

	ΣS_1	ΣS_2	ΣS_3	ΣS_4	ΣS_5	HI	QP(1 ω)
	-0.1258	-0.1334	-0.0221	-0.1163	-0.4042	61.3	-2%
h 或 ω %	LA'	$\Delta H'$	x'_i	x_e	$x'_i - x_e$	K'_{T1}	$K'_{T0.7}$
100	0.1211	-1.2297	-0.1243	0.0854	-0.2097	4.1326	0.7871
70	-0.6605	-0.4519	-0.6419	-0.6285	-0.0134	1.3766	0.0727

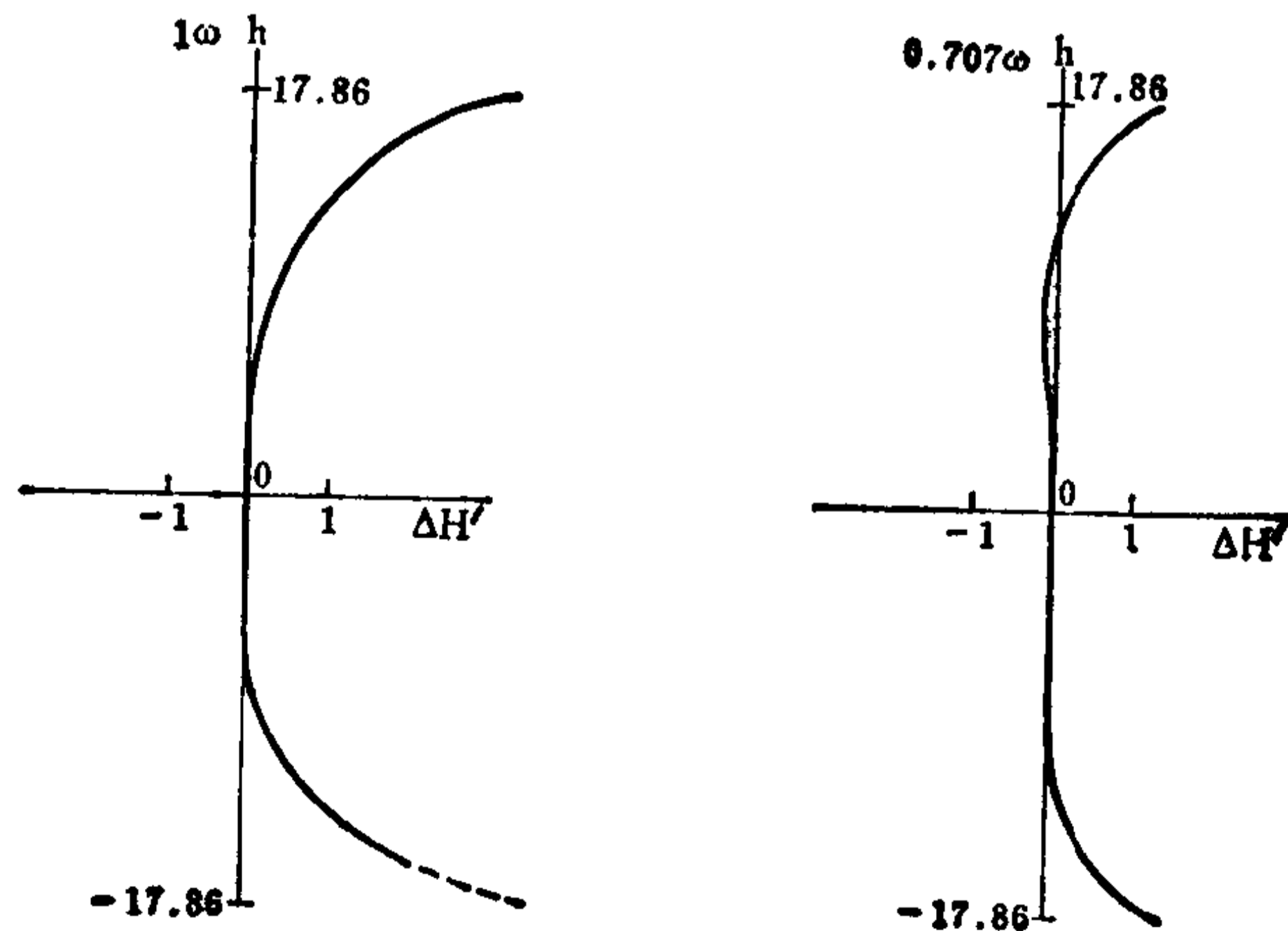
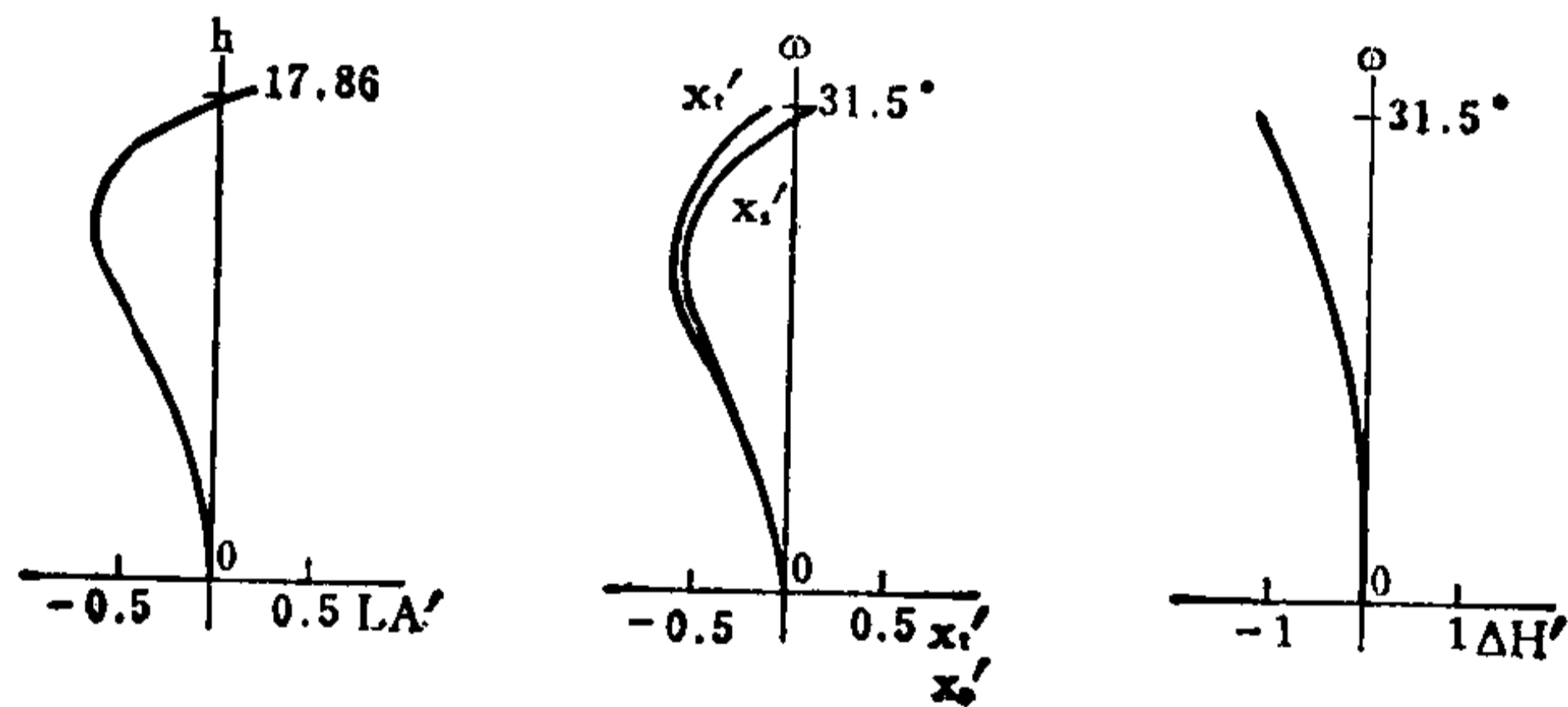

编号: 05-04-055

校正了球差、象散、色差的对称型摄影及重显透镜系统

E.F.L=99.94

B.F.L=92.60

FNo.=9

F.A.=±20°**

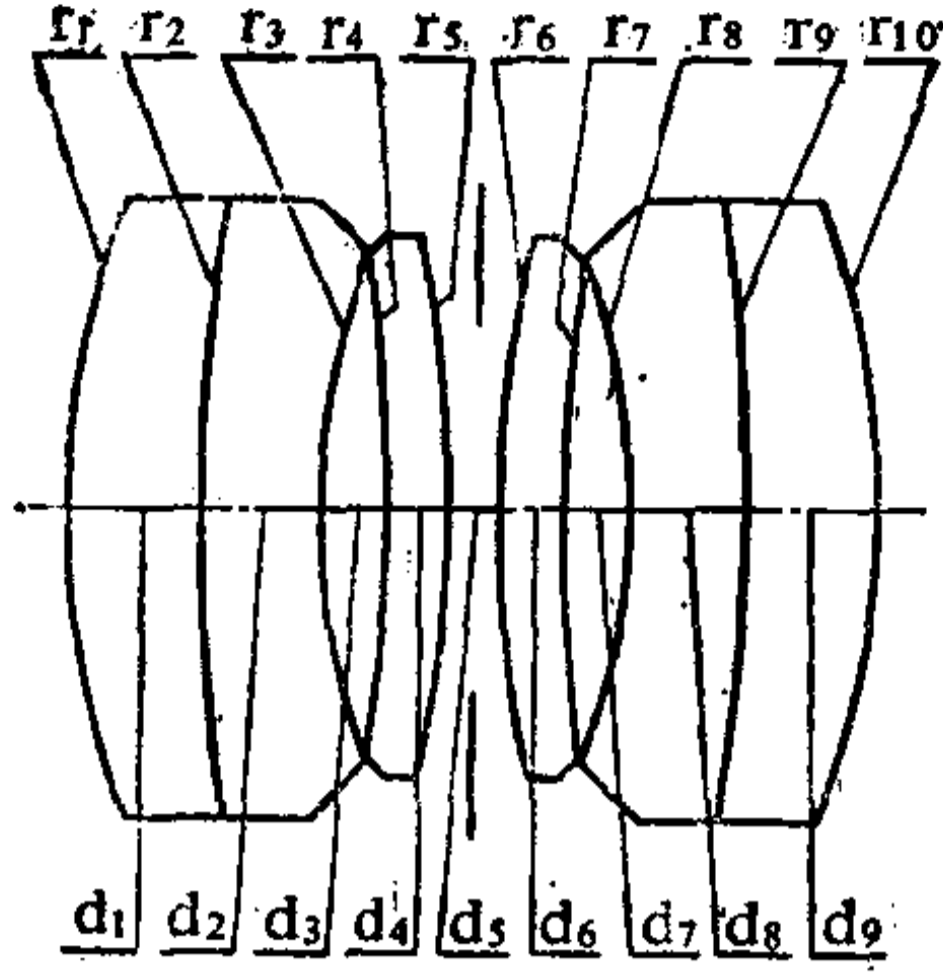

序号	r	d	n _d	v	序号	r	d	n _d	v
1	18.56	2.81	1.61900	60.6	6	27.00	1.42	1.52220	52.8
2	59.45	2.57	1.53562	45.4	7	37.04	1.31		
3	15.20	1.31			8	-15.20	2.57	1.53562	45.4
4	-37.04	1.42	1.52220	52.8	9	-59.45	2.81	1.61900	60.6
5	-27.00	1.08*			10	-18.56			

1.08* = 0.54 + 0.54

	ΣS ₁	ΣS ₂	ΣS ₃	ΣS ₄	ΣS ₅	HI	QP(1ω)
	-0.00035	-0.00286	0.00106	-0.00385	-0.00102	36.5	-0.03%
h 或 ω %	LA'	ΔH'	x _t '	x _s '	x _t ' - x _s '	K _{T1}	K _{T0.7}
100	0.1357	-0.0095	-0.1261	-0.0696	-0.0565	-0.1093	-0.0434
70	0.0176	-0.0034	-0.0390	-0.1394	0.1004	-0.0809	-0.0327

注: 以上象差值是按 l = -∞ 计算的。

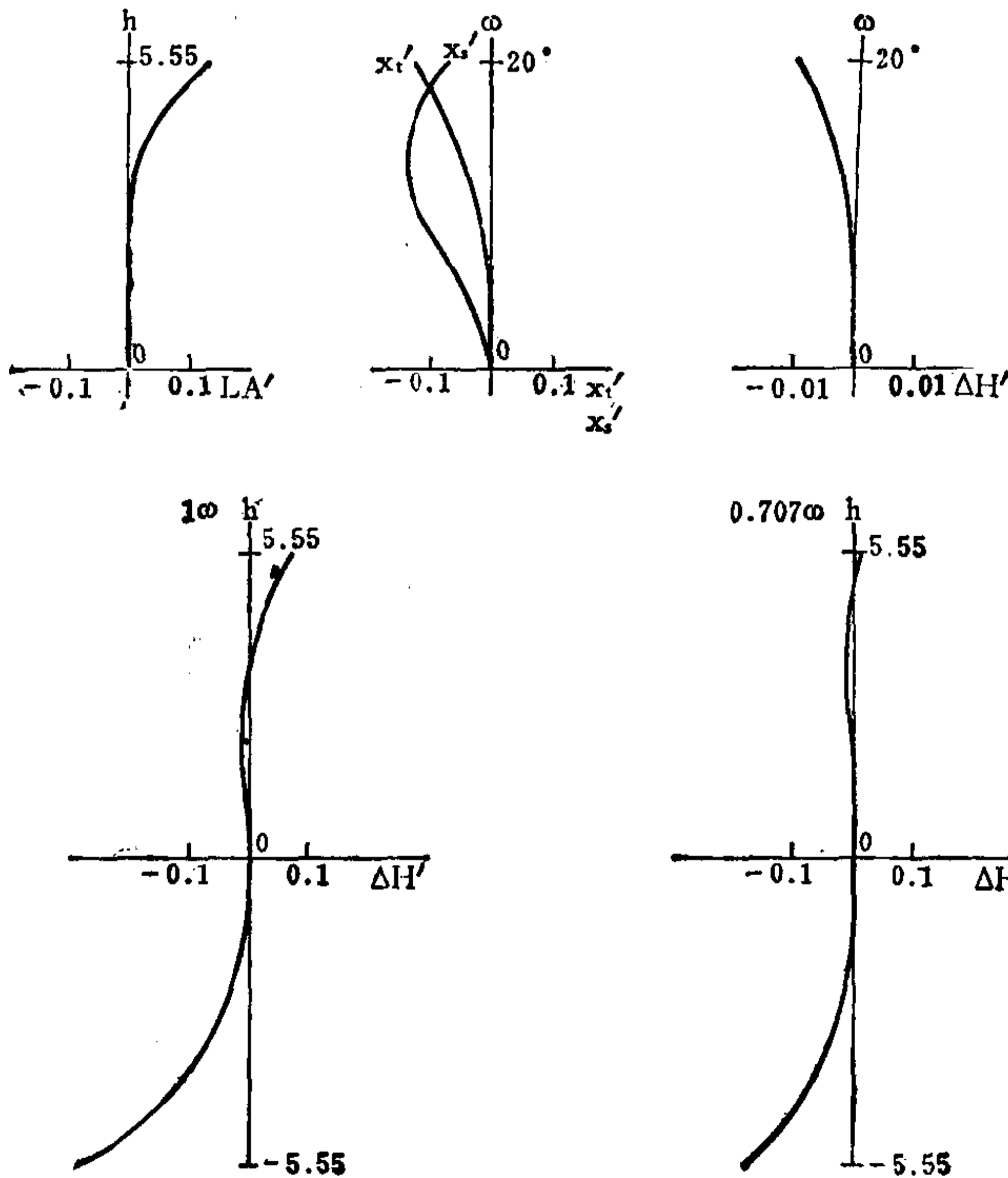

编号: 05-04-056

三片型工业电视镜头

E.F.L=154.34

B.F.L=0

FNo.=4.1

F.A.=±3.2°

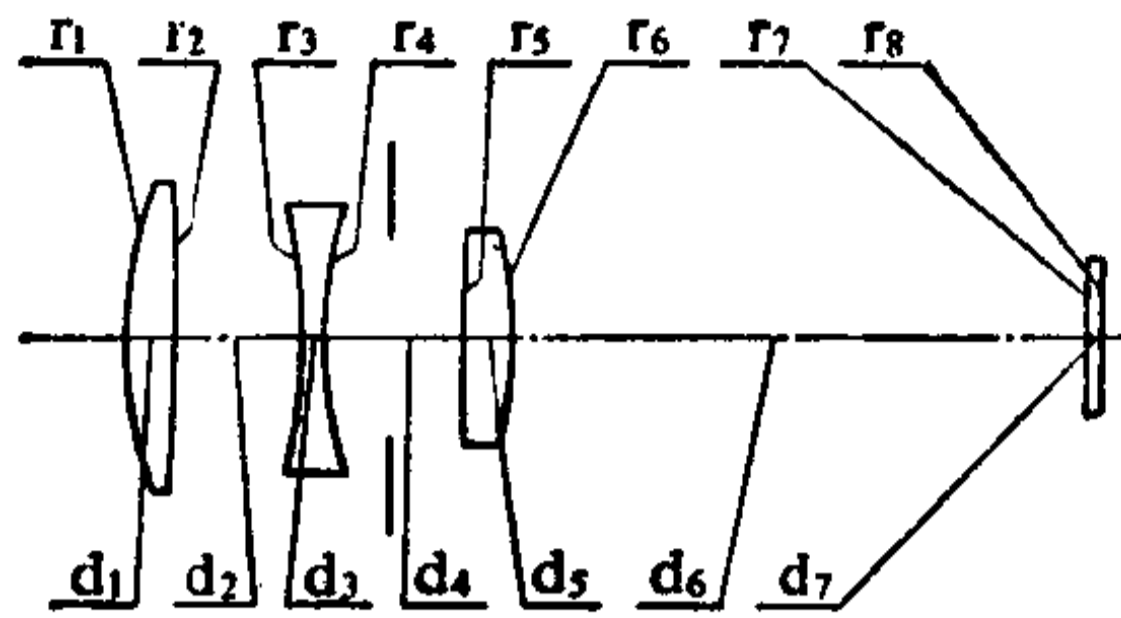

序号	r	d	n _D	v _D	序号	r	d	n _D	v _D
1	57.650	6.000	1.6384	55.5	5	378.700	6.000	1.6384	55.5
2	-2592.560	16.455			6	-62.000	127.063		
3	-77.415	3.100	1.6475	33.9	7	∞	2.600	1.5163	64.1
4	59.280	17.805*			8	∞			

17.805* = 8.000 + 9.805

注: 第四片为靶面玻璃。

	ΣS ₁	ΣS ₂	ΣS ₃	ΣS ₄	ΣS ₅	HI	QP(1ω)
	-0.02916	-0.00179	0.00159	-0.00268	0.00005	8.5	0.002%
h 或 ω%	LA'	ΔH'	x _i	x _s	x _i - x _s	K _{T1}	K _{T0.7}
100	0.2056	0.00021	0.0715	-0.0360	0.1075	-0.06409	-0.01975
70	-0.2377	0.00007	0.0355	-0.0182	0.0537	-0.04468	-0.01371

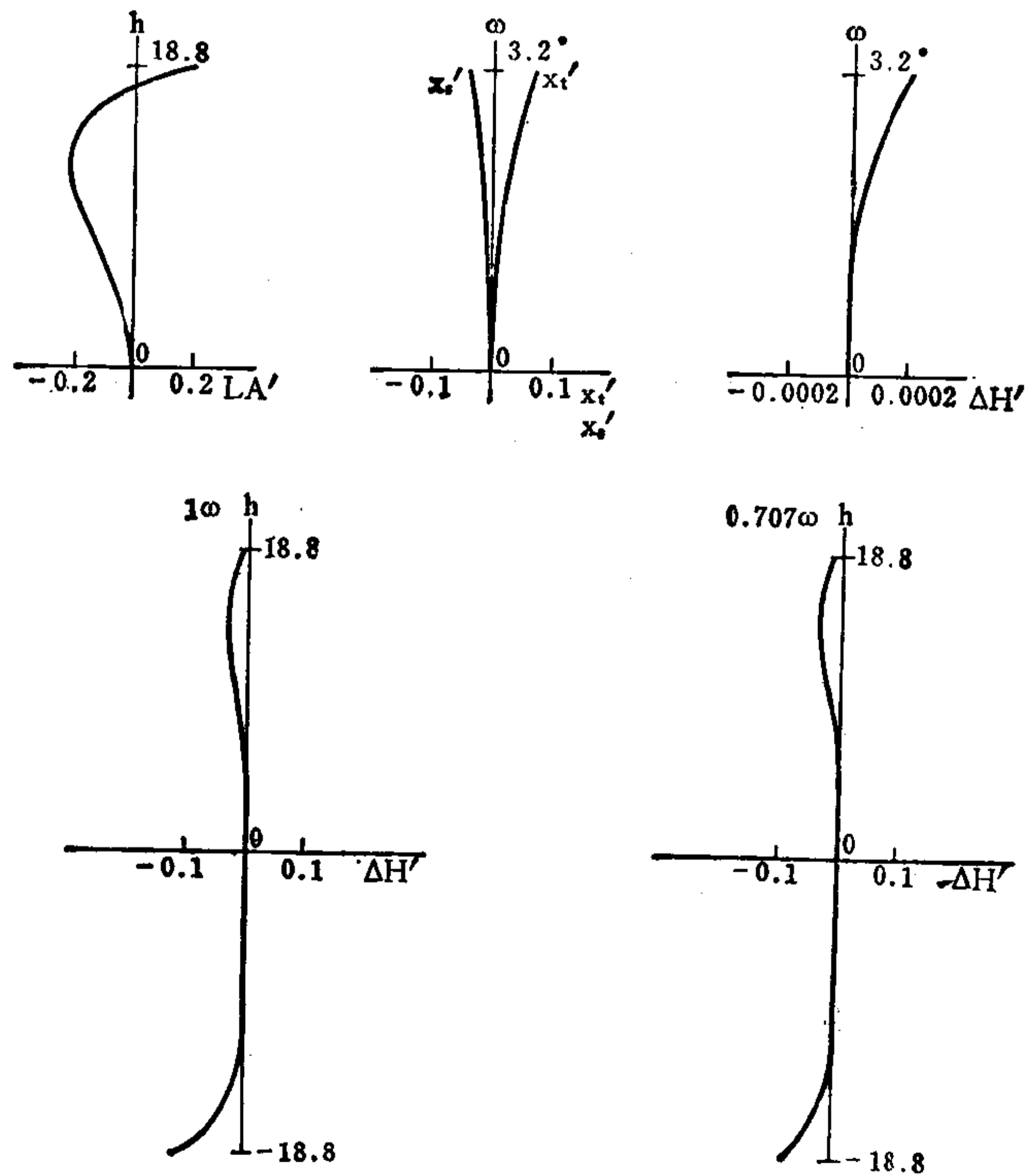

编号: 05-04-057

短焦距摄影及投影物镜

E.F.L=100.99

B.F.L=101.70

FN₀. = 2.02

F.A. = ± 9°**

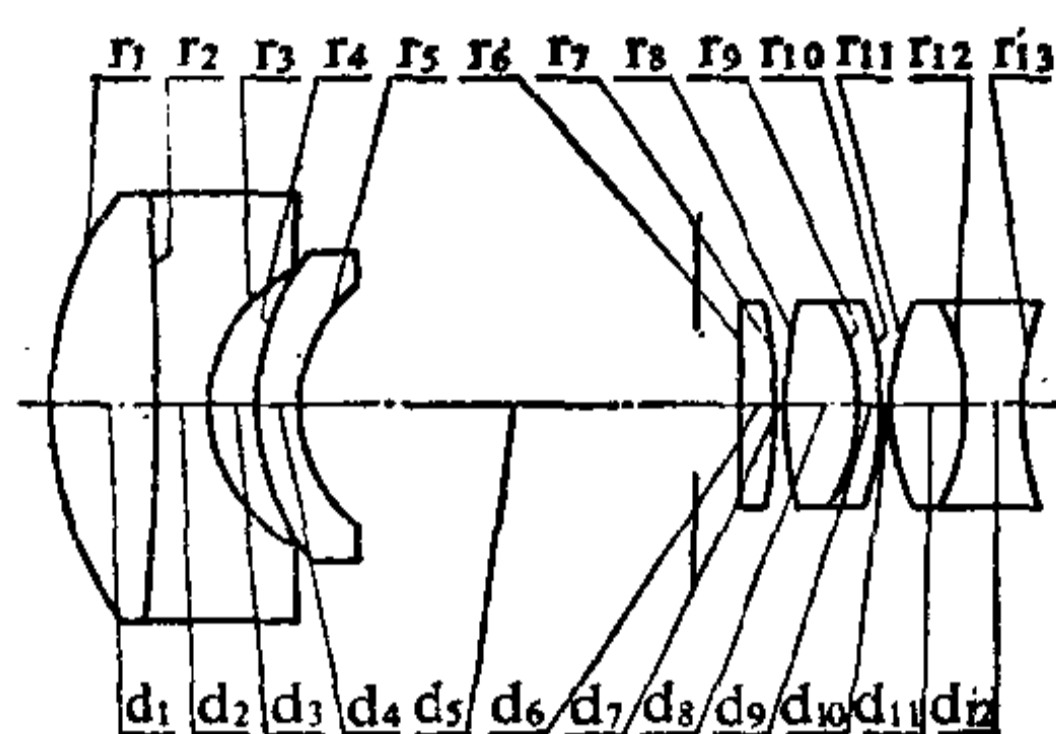

序号	r	d	n _d	v	序号	r	d	n _d	v
1	174.0	47.2	1.757	47.8	8	214.4	29.6	1.517	64.1
2	-1548.7	23.5	1.501	56.4	9	-88.2	9.7	1.689	31.2
3	68.7	21.5			10	-139.4	5.0		
4	131.6	20.1	1.620	38.1	11	118.7	32.7	1.501	56.4
5	70.8	196.7*			12	-96.0	26.7	1.648	33.8
6	-1779.0	15.0	1.733	51.6	13	140.2			
7	-220.9	6.7							

196.7* = 175.0 + 21.7

	ΣS ₁	ΣS ₂	ΣS ₃	ΣS ₄	ΣS ₅	HI	QP(1ω)
	-0.03765	-0.00051	-0.00299	-0.00004	-0.03275	15.99	-0.39%
h 或 ω %	LA'	ΔH'	x _i '	x _s '	x _i ' - x _s '	K _{T1}	K _{T0.7}
100	0.8317	-0.0629	-0.1181	-0.0207	-0.0974	0.30137	0.05713
70	0.0250	-0.0230	-0.0477	-0.0115	-0.0362	0.22253	0.04176

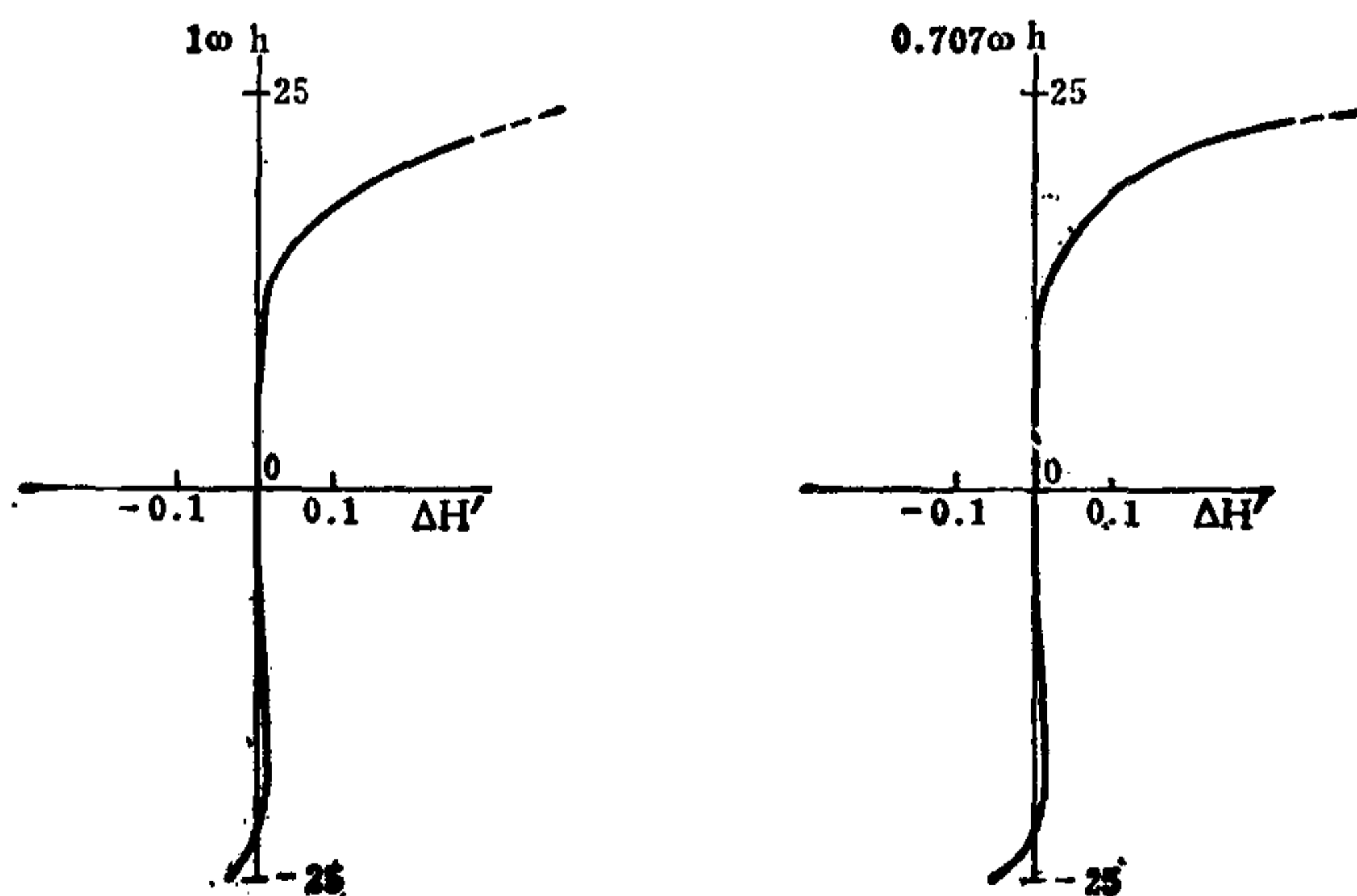
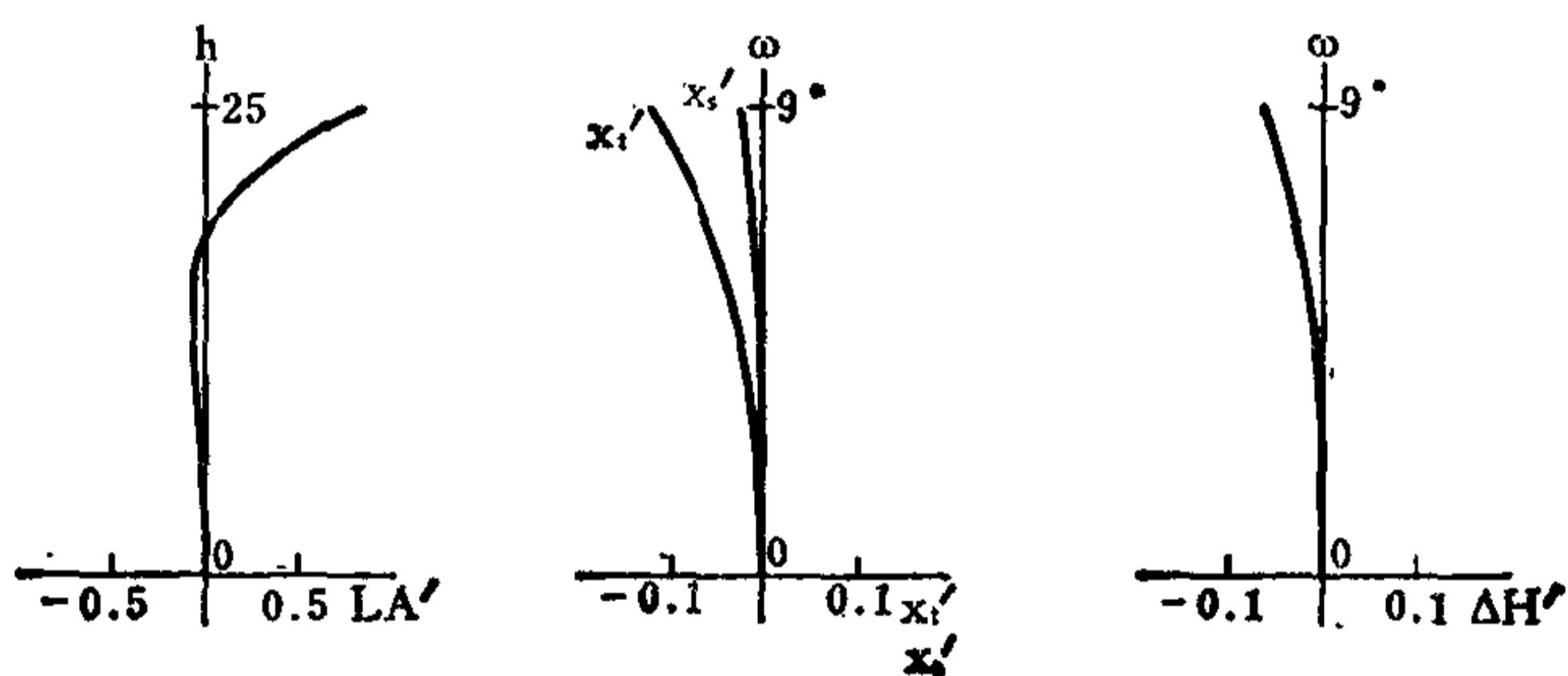

编号: 05-04-058

分裂式达格型对称复制透镜系统

E.F.L = 10.236

B.F.L = 8.803

FN₀ = 5.6

F.A. = ± 30°**

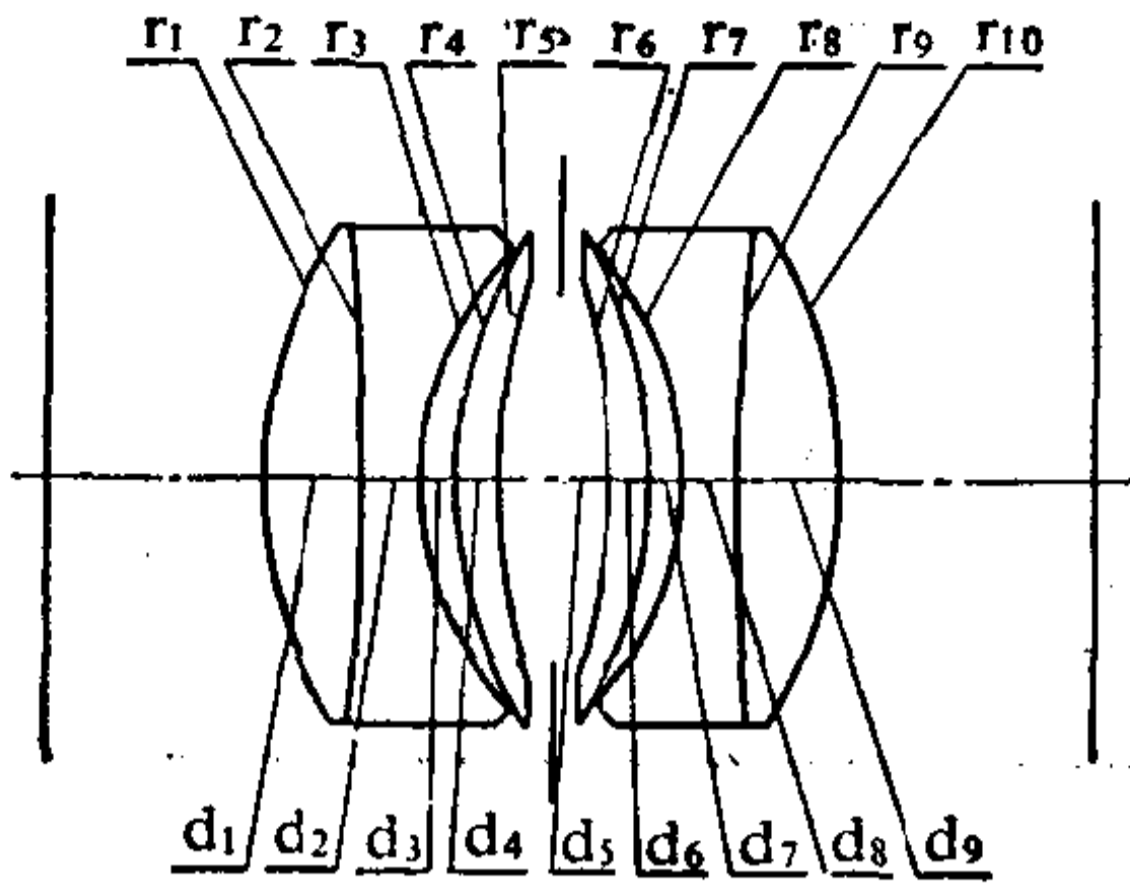

序号	r	d	n _d	v	序号	r	d	n _d	v
1	2.553	0.541	1.658	50.8	6	-3.761	0.235	1.623	57.0
2	-29.745	0.309	1.582	42.1	7	-2.585	0.167		
3	1.860	0.167			8	-1.860	0.309	1.582	42.1
4	2.585	0.235	1.623	57.0	9	29.745	0.541	1.658	50.8
5	3.761	0.562*			10	-2.553			

0.562* = 0.281 + 0.281

	ΣS ₁	ΣS ₂	ΣS ₃	ΣS ₄	ΣS ₅	HI	QP(1ω)
	-0.00097	-0.00152	-0.00029	-0.00209	0.00249	5.9	0.4%
h 或 ω %	LA'	ΔH'	x _t '	x _s '	x _t ' - x _s '	K _{T1}	K _{T0.7}
100	0.0295	0.0254	0.0977	0.1061	-0.0084	-0.02357	-0.01587
70	-0.0108	0.0069	-0.0448	-0.0269	-0.0179	-0.02205	-0.01075

注: 以上象差值是按 l = -∞ 计算的。

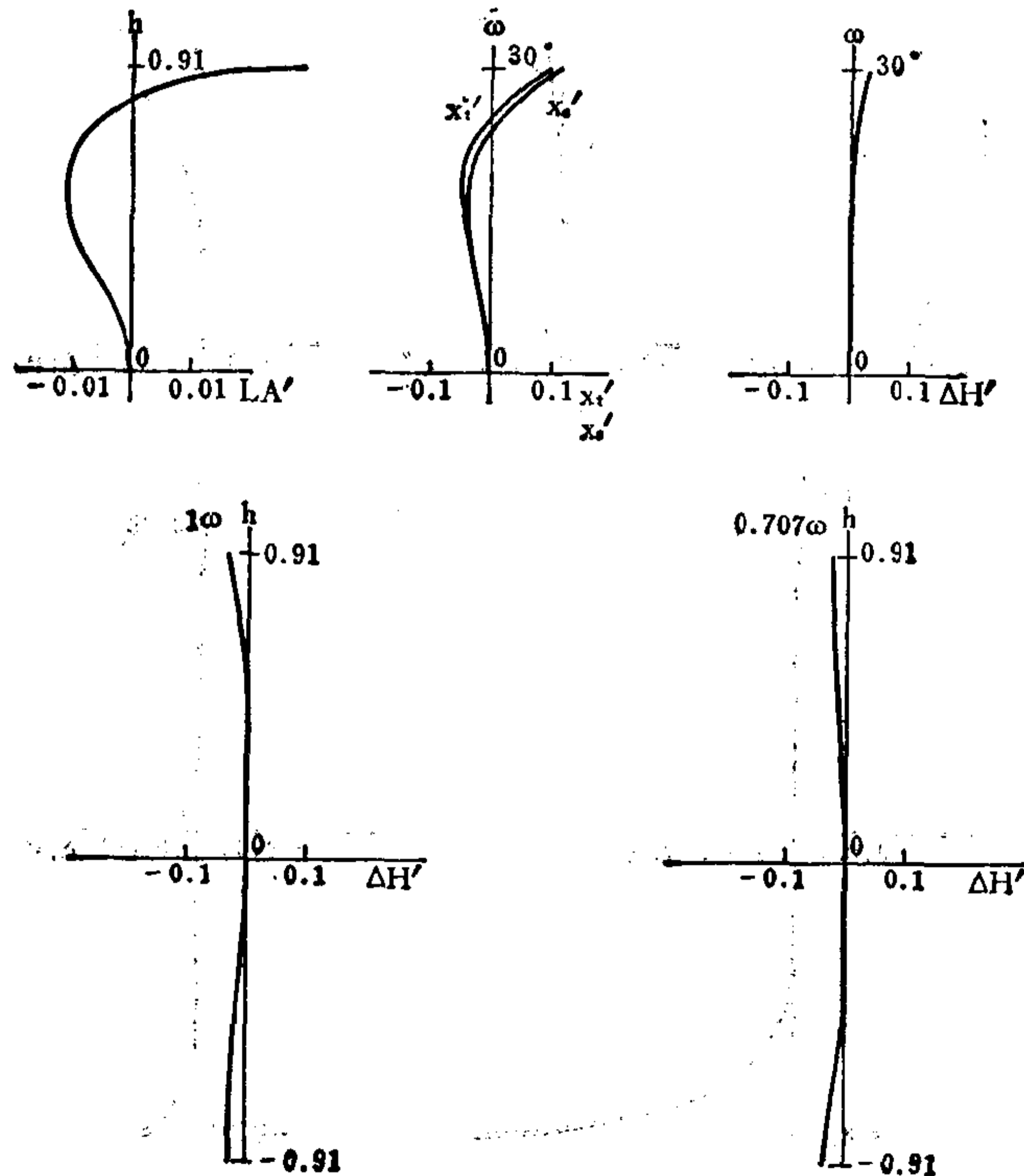

编号: 05-04-059

远 距 离 照 相 镜 头

E.F.L=1.0

B.F.L=0.24158

FNo.=6.3

F.A.=±3.04°

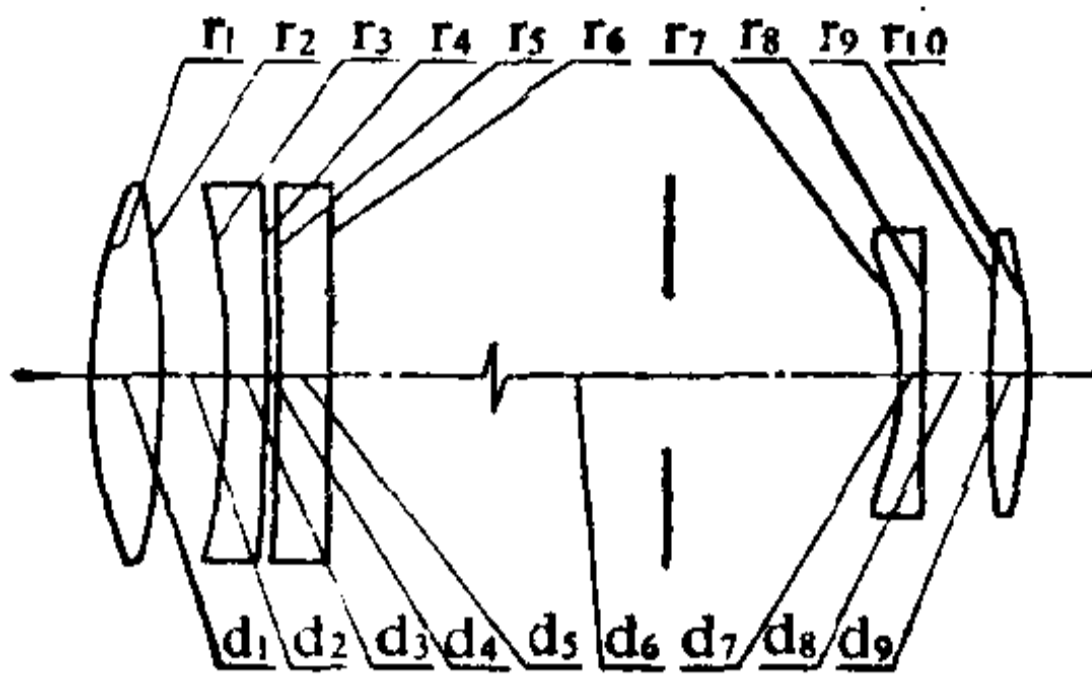

序号	r	d	n	v	序号	r	d	n	v
1	0.22205	0.02996	1.48749	70.1	6	∞	0.35601*		
2	-0.41049	0.02693			7	-0.12905	0.00917	1.65100	56.2
3	-0.31939	0.01864	1.74950	35.2	8	5.90492	0.02928		
4	-1.09410	0.00506			9	1.26755	0.01305	1.60342	38.0
5	-1.72402	0.02122	1.59270	35.6	10	-0.24132			

$0.35601^* = 0.25601 + 0.10000$

	ΣS_1	ΣS_2	ΣS_3	ΣS_4	ΣS_5	HI	QP(1 ω)
	-0.0000281	0.0000084	-0.0000026	0.0000028	0.0000283	0.053	0.34%
h 或 ω %	LA'	$\Delta H'$	x_t	x_s	$x_t - x_s$	K_{T1}	$K_{T0.7}$
100	-0.000044	0.000181	-0.000322	0.000047	-0.000369	0.002613	0.000200
70	-0.000541	0.000063	-0.000123	0.000023	-0.000146	0.000372	0.000002

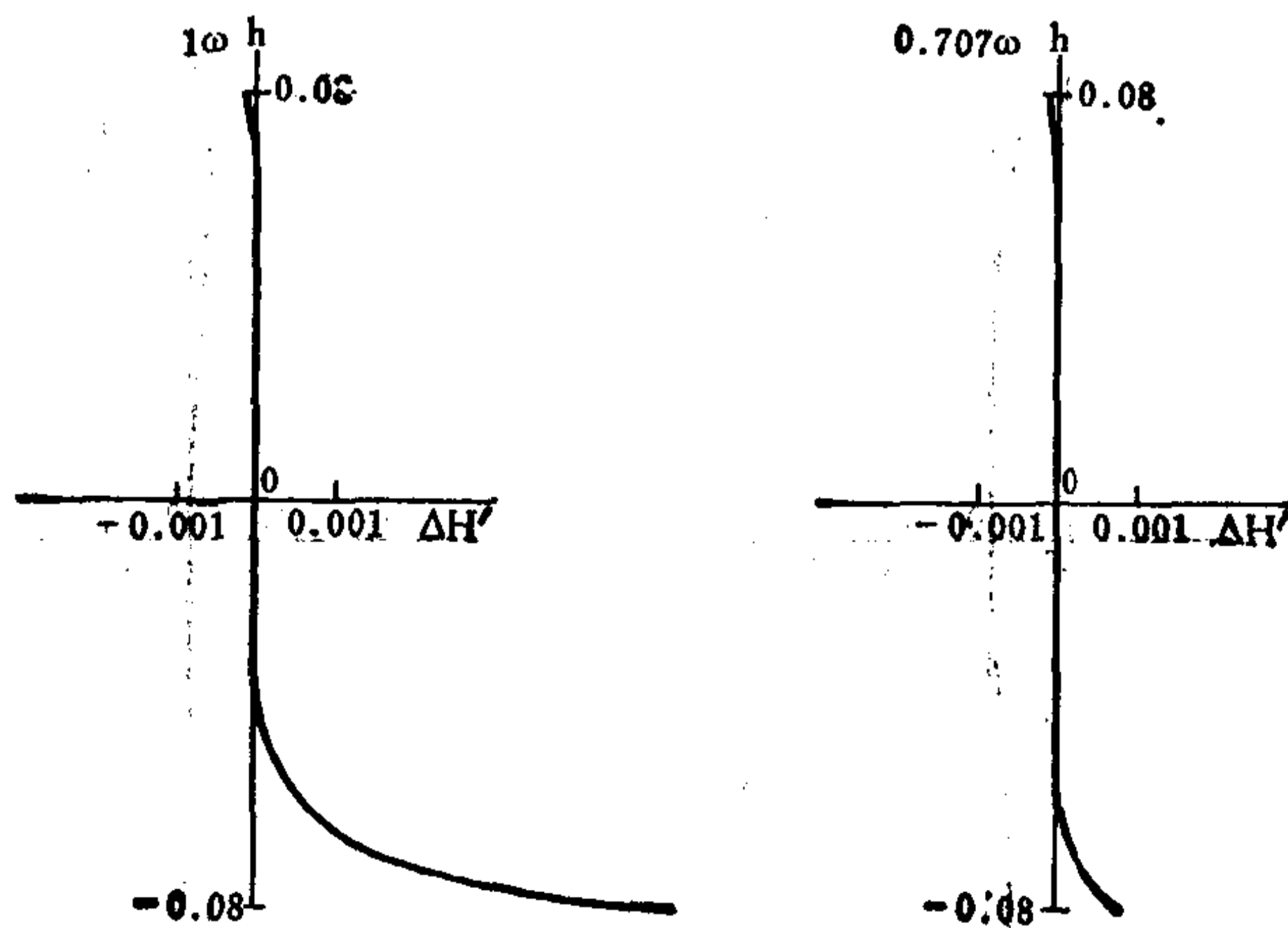
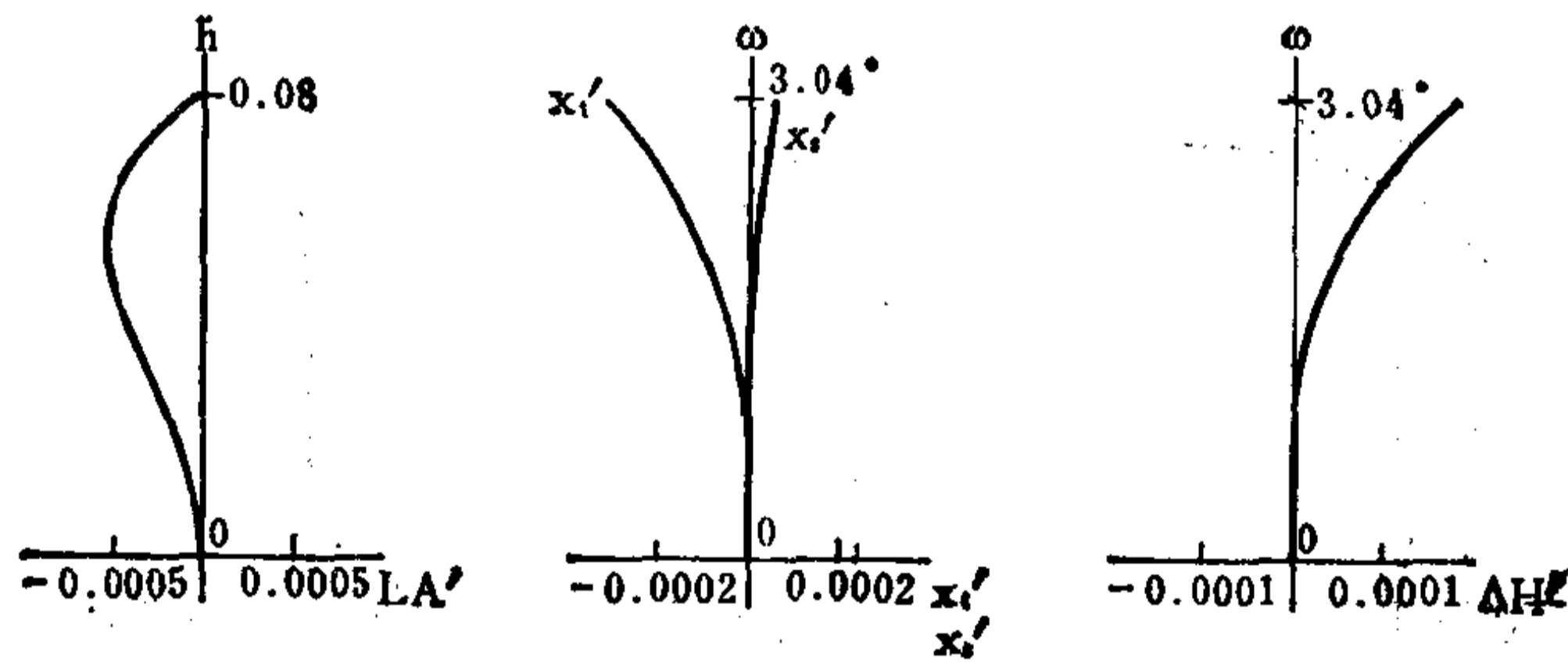

编号: 05-04-060

三组元重显物镜

E.F.L = 100.05

B.F.L = 86.64

FNo. = 4.5

F.A. = ±25°**

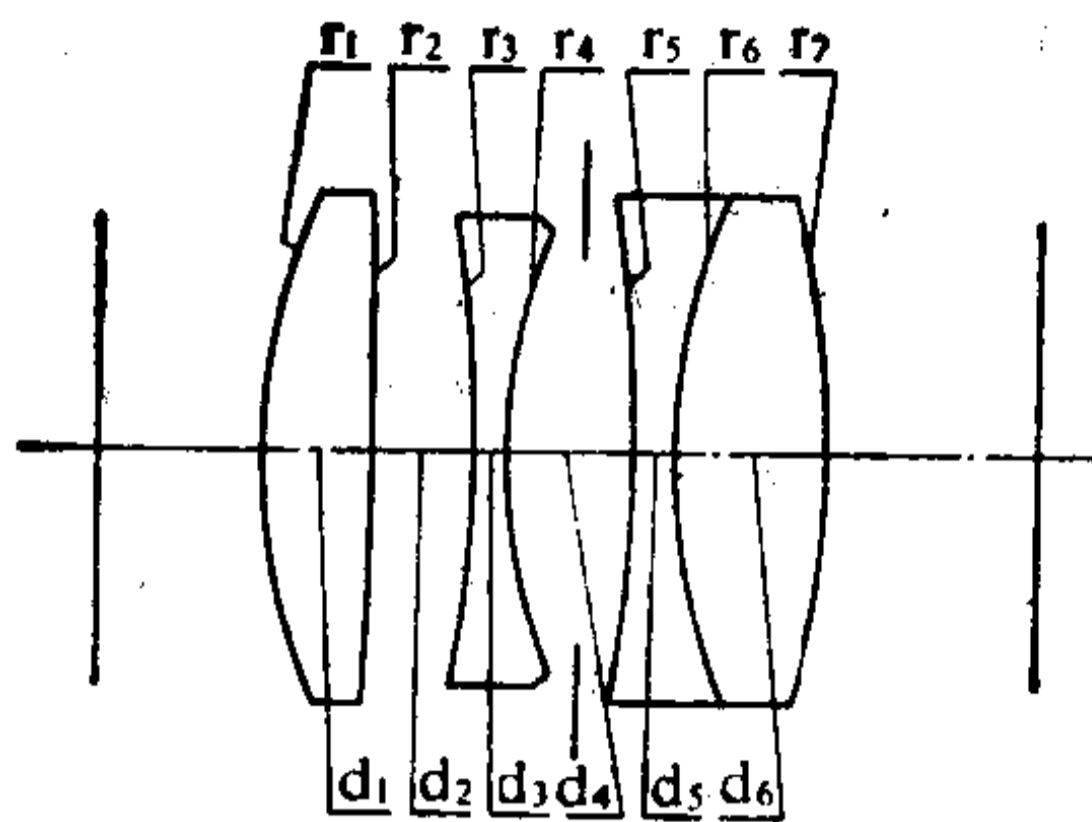

序号	r	d	n _d	v	序号	r	d	n _d	v
1	27.36	4.55	1.62041	60.3	5	-142.92	1.74	1.53172	48.9
2	-1978.05	4.36			6	28.52	6.59	1.65844	50.8
3	-62.69	1.65	1.59551	39.2	7	-41.81			
4	25.30	5.23*							

5.23* = 3.00 + 2.23

	ΣS ₁	ΣS ₂	ΣS ₃	ΣS ₄	ΣS ₅	HI	QP(1ω)
	-0.03797	0.00341	0.00715	-0.05057	0.03632	46.61	0.44%
h 或 ω %	LA'	ΔH'	x _i '	x _s '	x _i ' - x _s '	K _{T1} '	K _{T0.7} '
100	-0.1292	0.2077	-0.7084	0.1977	-0.9061	-0.7421	-0.1967
70	-0.4816	0.0635	-0.2575	-0.4863	0.2288	-0.3139	-0.0711

注: 1. M = 2^x ~ 10^x,

2. 以上象差值是按 l = -∞ 计算的。

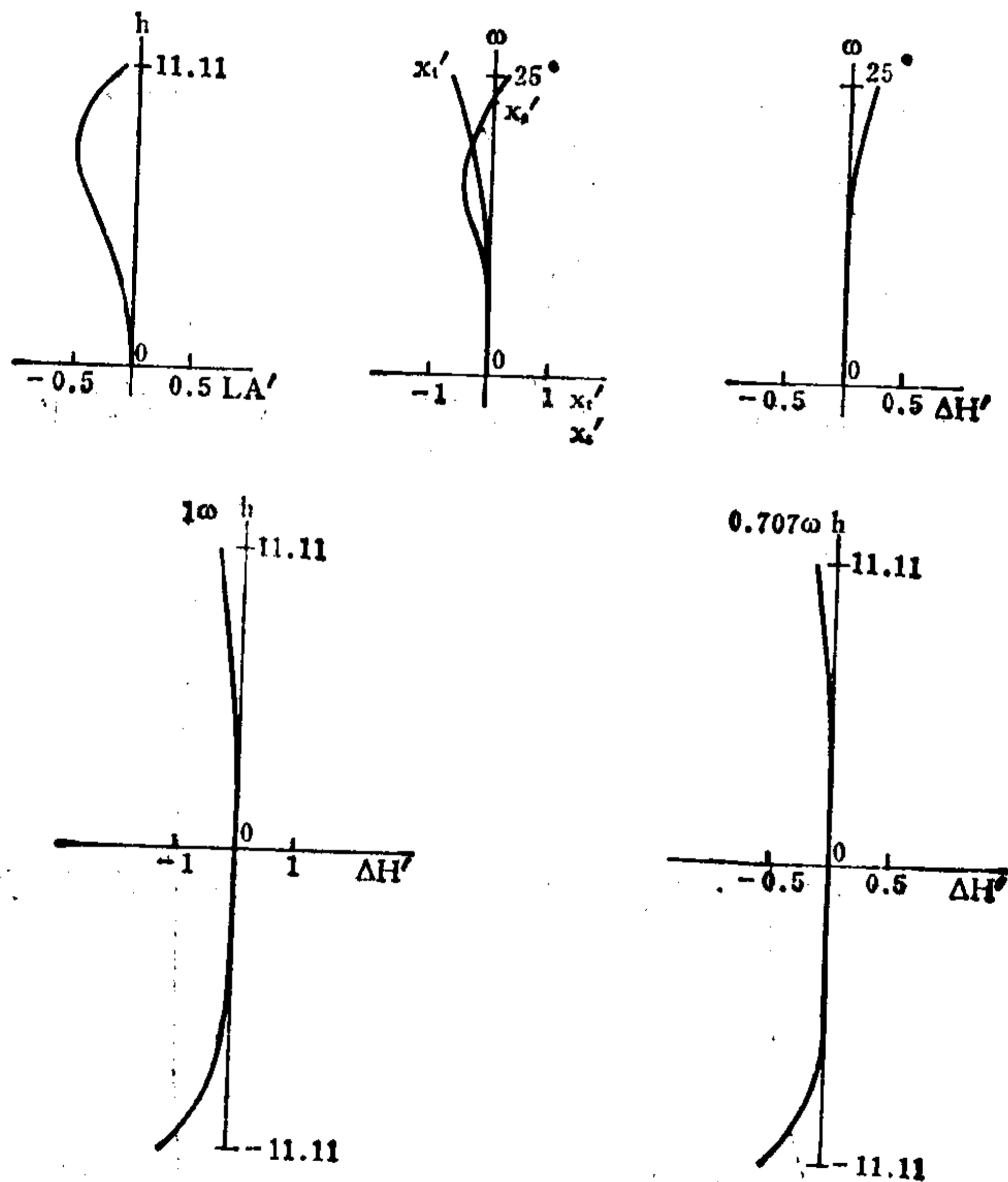

编号: 05-04-061

大视场透镜系统

E.F.L=1.0

B.F.L=0.359

FNo.=3

F.A.=±22.5°

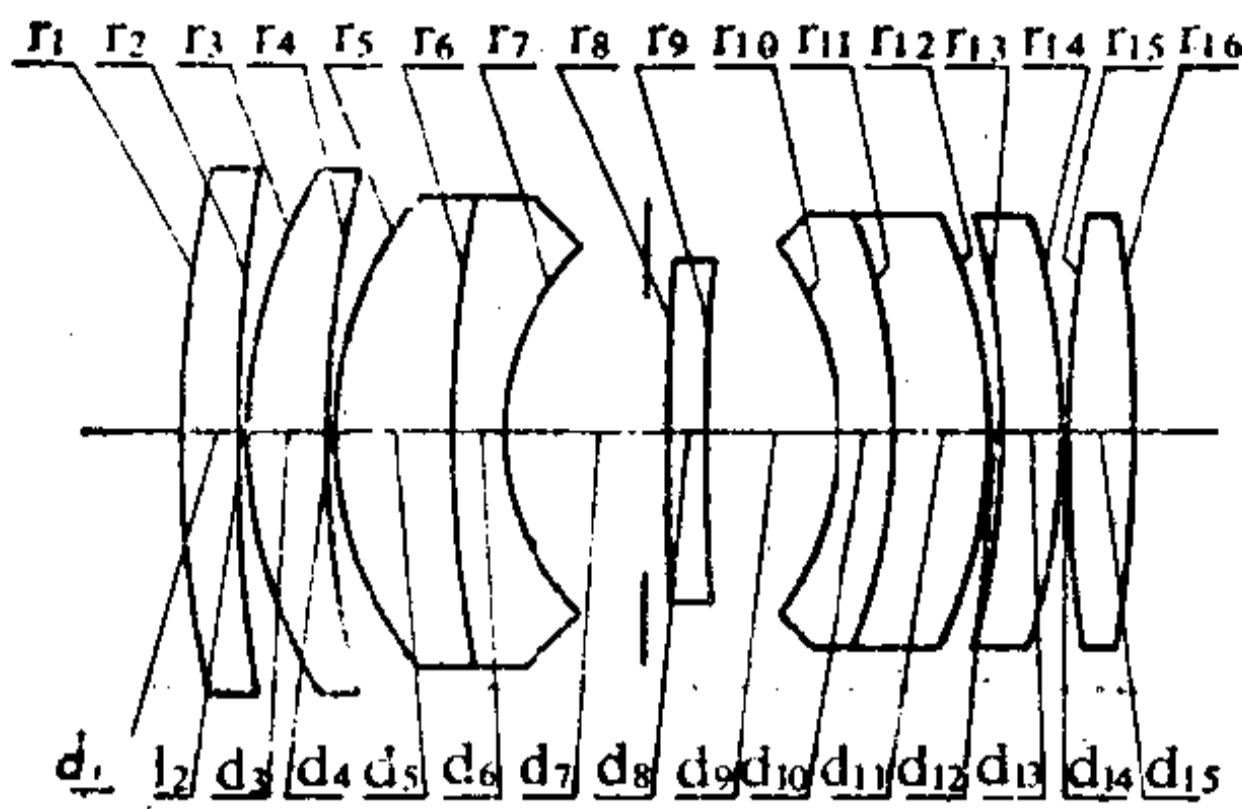

序号	r	d	n _D	v _D	序号	r	d	n _D	v _D
1	1.2090	0.0543	1.69089	54.80	9	2.2438	0.1141		
2	2.9152	0.0054			10	-0.2775	0.0435	1.60328	38.02
3	0.4459	0.0679	1.69089	54.80	11	-0.6014	0.0870	1.69089	54.80
4	0.9530	0.0054			12	-0.4394	0.0054		
5	0.3691	0.1033	1.69089	54.80	13	-0.7768	0.0543	1.69089	54.80
6	1.3253	0.0435	1.64752	33.88	14	-0.6610	0.0054		
7	0.2195	0.1408*			15	1.3292	0.0543	1.69089	54.80
8	6.3772	0.0326	1.64752	33.88	16	-1.4244			

0.1408* = 0.1208 + 0.0200

	ΣS ₁	ΣS ₂	ΣS ₃	ΣS ₄	ΣS ₅	HI	QP(1ω)
	0.000090	-0.000262	-0.000270	-0.000338	0.007274	0.41	7.1%
h 或 ω%	LA'	ΔH'	x _t '	x _s '	x _t ' - x _s '	K _{T1}	K _{i0.7}
100	0.00243	0.0295	0.00257	0.00893	-0.00636	-0.00521	-0.00257
70	0.00100	0.0087	-0.00792	-0.00223	-0.00569	-0.00224	-0.00111

注: 1. 实际的使用值是E.F.L=184;

2. M = 0.2*。

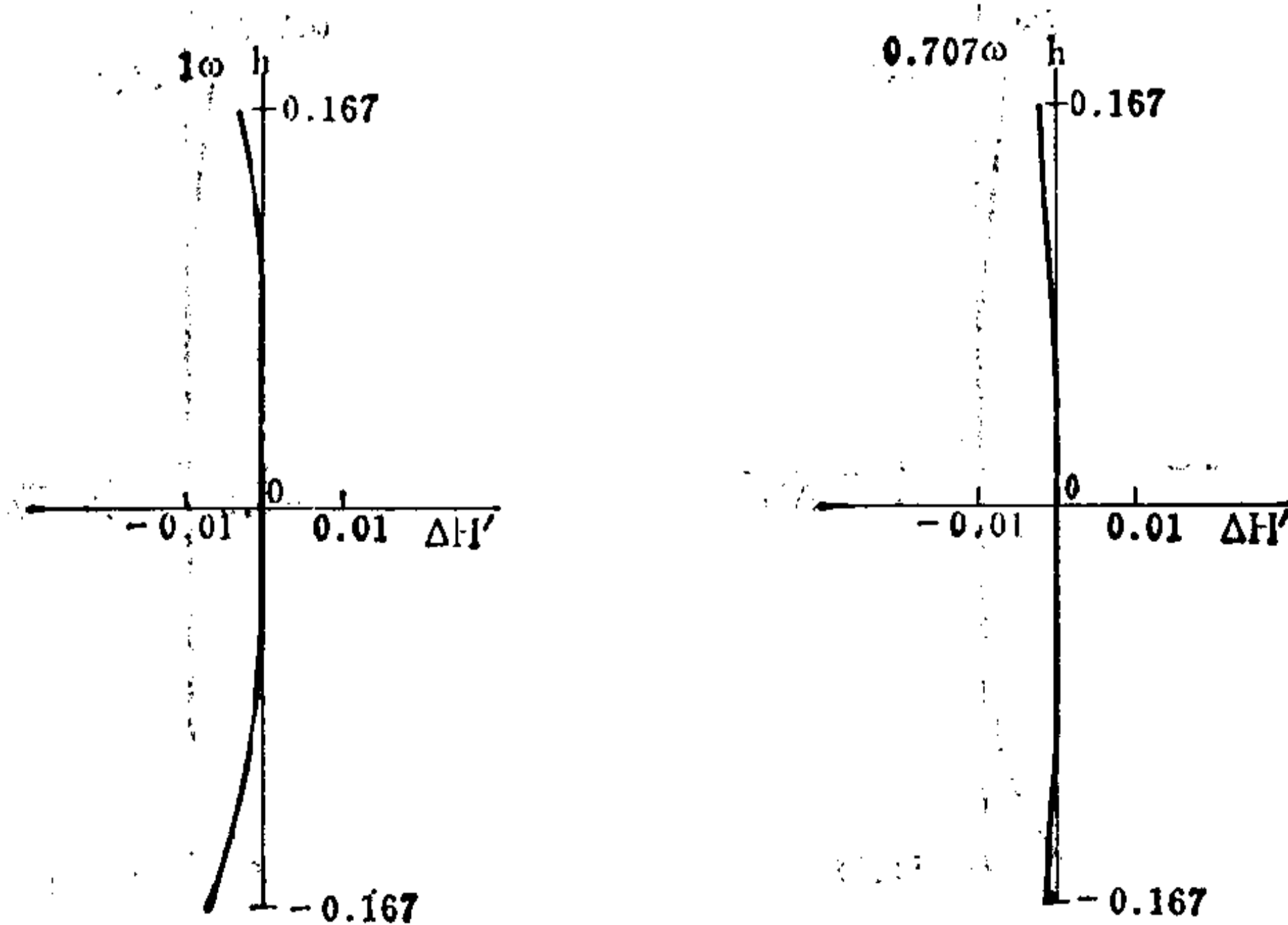
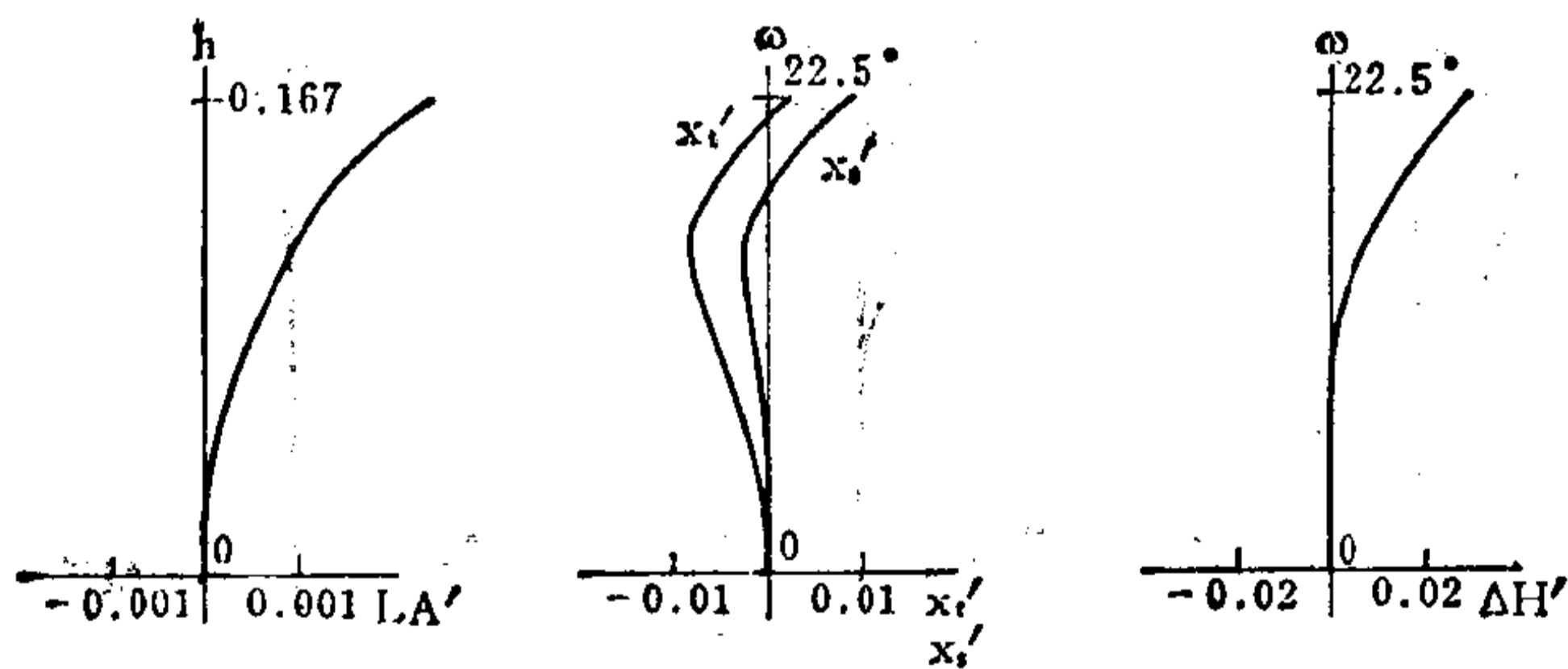

编号: 05-04-062

大视场透镜系统

E.F.L=1.0

B.F.L=0.4586

FNo.=4

F.A.=±22.5°

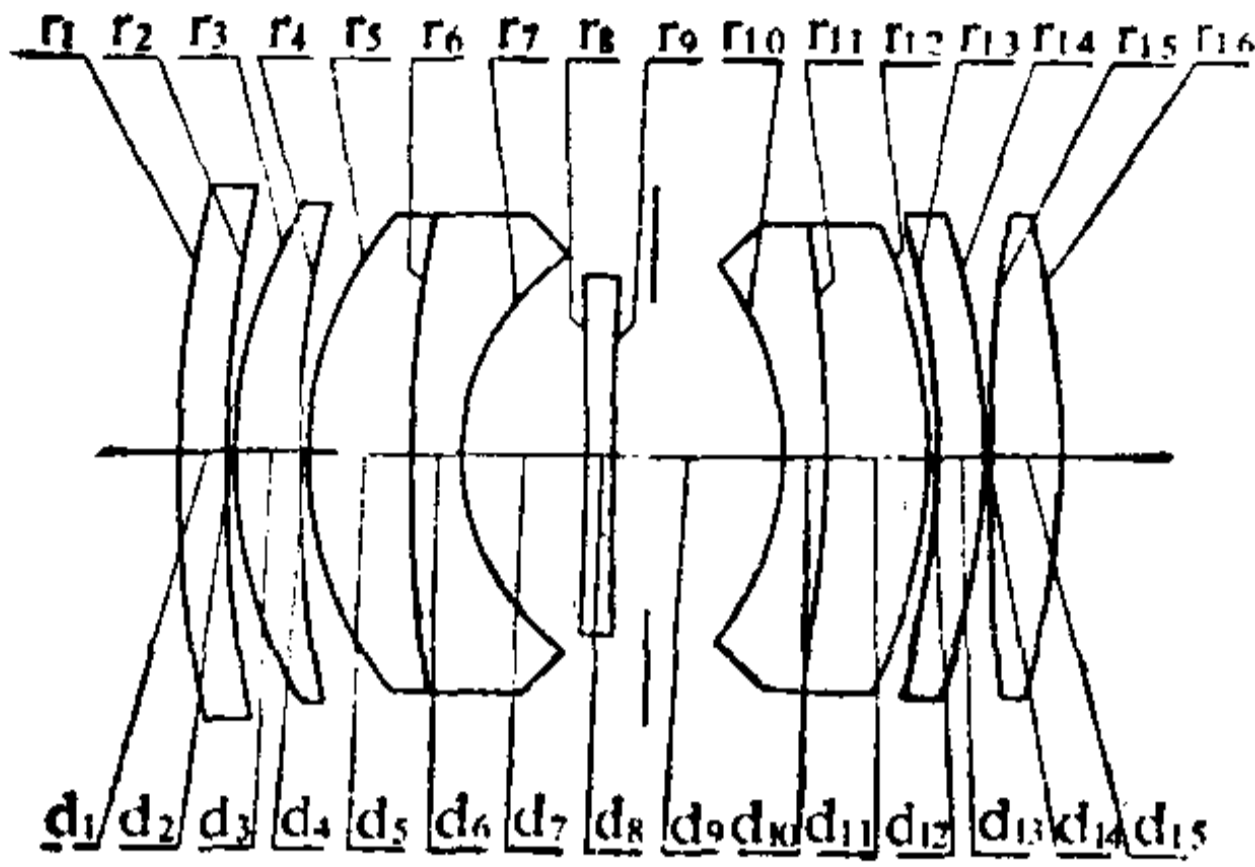

序号	r	d	n_D	ν_D	序号	r	d	n_D	ν_D
1	1.1595	0.0416	1.69089	54.80	9	5.8480	0.1408*		
2	1.6344	0.0052			10	-0.2729	0.0377	1.60328	38.02
3	0.4209	0.0571	1.69089	54.80	11	-1.3645	0.0909	1.69089	54.80
4	0.9905	0.0052			12	-0.4587	0.0052		
5	0.3319	0.0922	1.69089	54.80	13	-0.6899	0.0442	1.69089	54.80
6	2.5044	0.0377	1.64752	33.88	14	-0.6287	0.0052		
7	0.2075	0.1065			15	2.2256	0.0571	1.69089	54.80
8	-32.9440	0.0260	1.64752	33.88	16	-0.9501			

$0.1408^* = 0.0300 + 0.1108$

	ΣS_1	ΣS_2	ΣS_3	ΣS_4	ΣS_5	HI	QP(1 ω)
	0.0000019	-0.0000635	0.0000195	-0.0001124	0.0017054	0.41	1.07%
h 或 $\omega\%$	LA'	$\Delta H'$	x'_t	x'_s	$x'_t - x'_s$	K'_{I1}	$K_{T0.7}$
100	0.000511	0.00442	0.02500	0.01479	0.01021	-0.001879	-0.000885
70	0.000139	0.00216	0.00405	0.00203	0.00202	-0.000863	-0.000405

注: 1. 实际的使用值是E.F.L=385;

2. $M=0.1^*$.

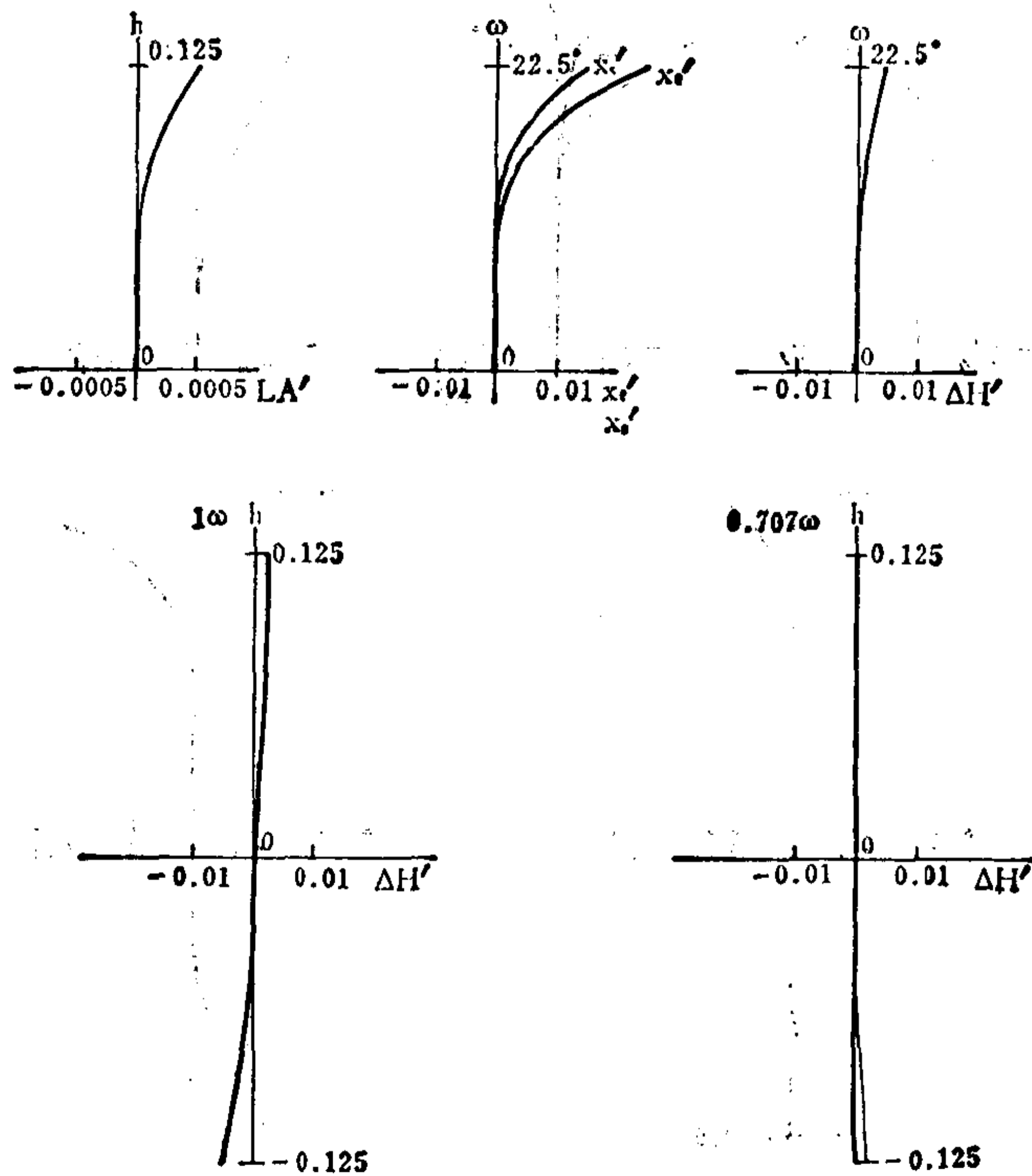

编号: 05-04-063

逆聚焦型透镜系统

E.F.L=100

B.F.L=189.3

FNo.=4

F.A. = ±47.9°

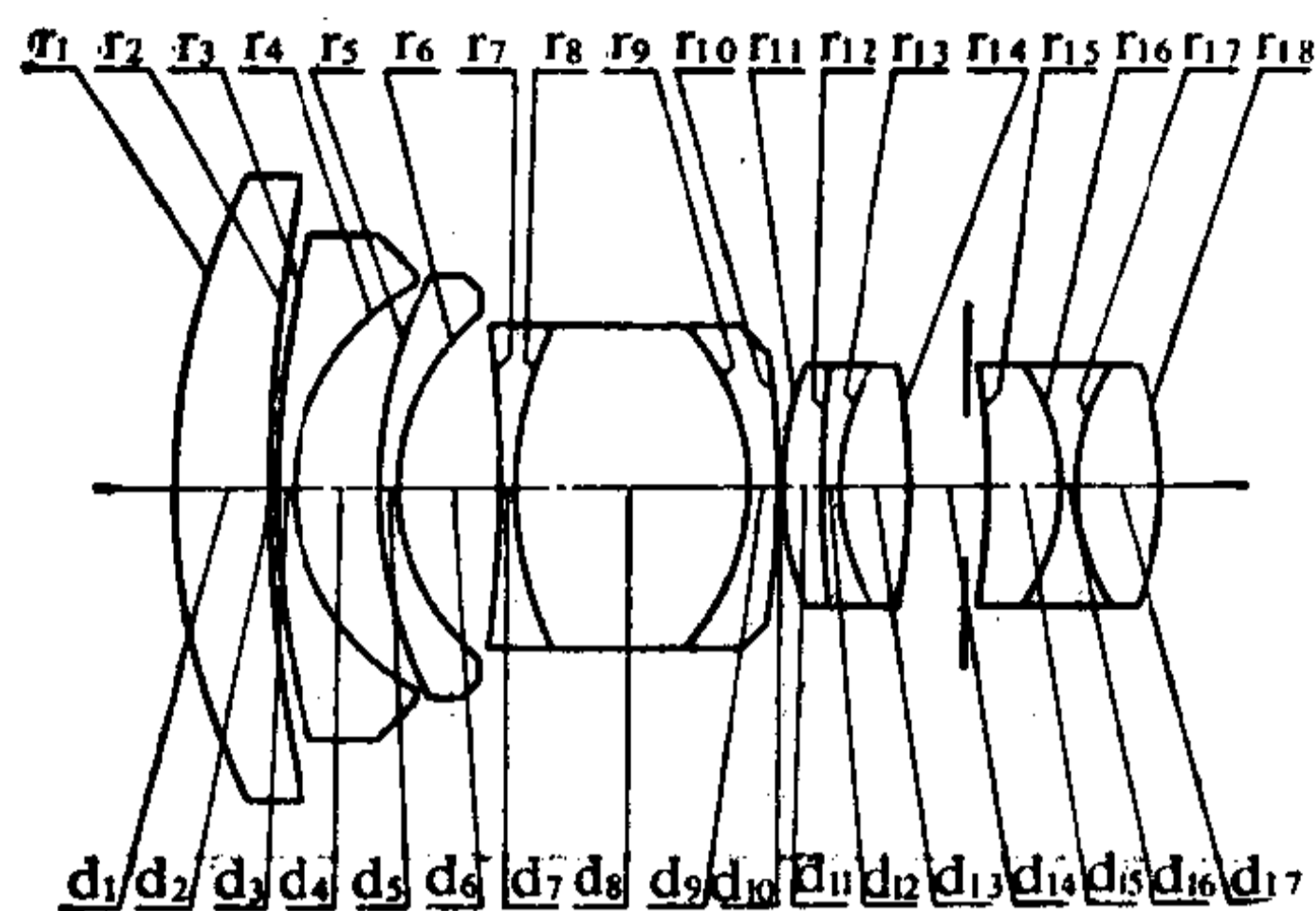

序号	r	d	n	v	序号	r	d	n	v
1	140.000	18.0	1.61720	54.0	10	-193.474	0.5		
2	406.149	0.5			11	60.500	7.5	1.59270	35.4
3	180.000	3.5	1.64000	60.2	12	180.000	3.0	1.74077	27.7
4	41.772	15.5			13	44.000	12.5	1.51118	50.9
5	88.000	3.5	1.64000	60.2	14	-119.362	14.0*		
6	41.814	18.0			15	-195.000	13.0	1.60729	49.3
7	-230.000	3.5	1.62041	60.3	16	-43.500	3.0	1.72342	38.0
8	70.000	42.0	1.66446	35.9	17	42.000	15.5	1.58921	41.0
9	-45.000	5.0	1.63980	34.6	18	-58.393			

14.0* = 10.0 + 4.0

	ΣS_1	ΣS_2	ΣS_3	ΣS_4	ΣS_5	HI	QP(1 ω)
	-0.1541	-0.0331	0.0562	-0.0058	-1.4384	110.67	-6.1%
h 或 ω %	LA'	$\Delta H'$	x_t	x'_s	$x_t - x_s$	K'_{T1}	$K'_{T0.7}$
100	8.0398	-6.8087	-9.668	-1.277	-8.391	-0.0310	-0.1000
70	-0.8661	-2.9294	-1.173	-0.365	-0.808	0.4992	-0.6916

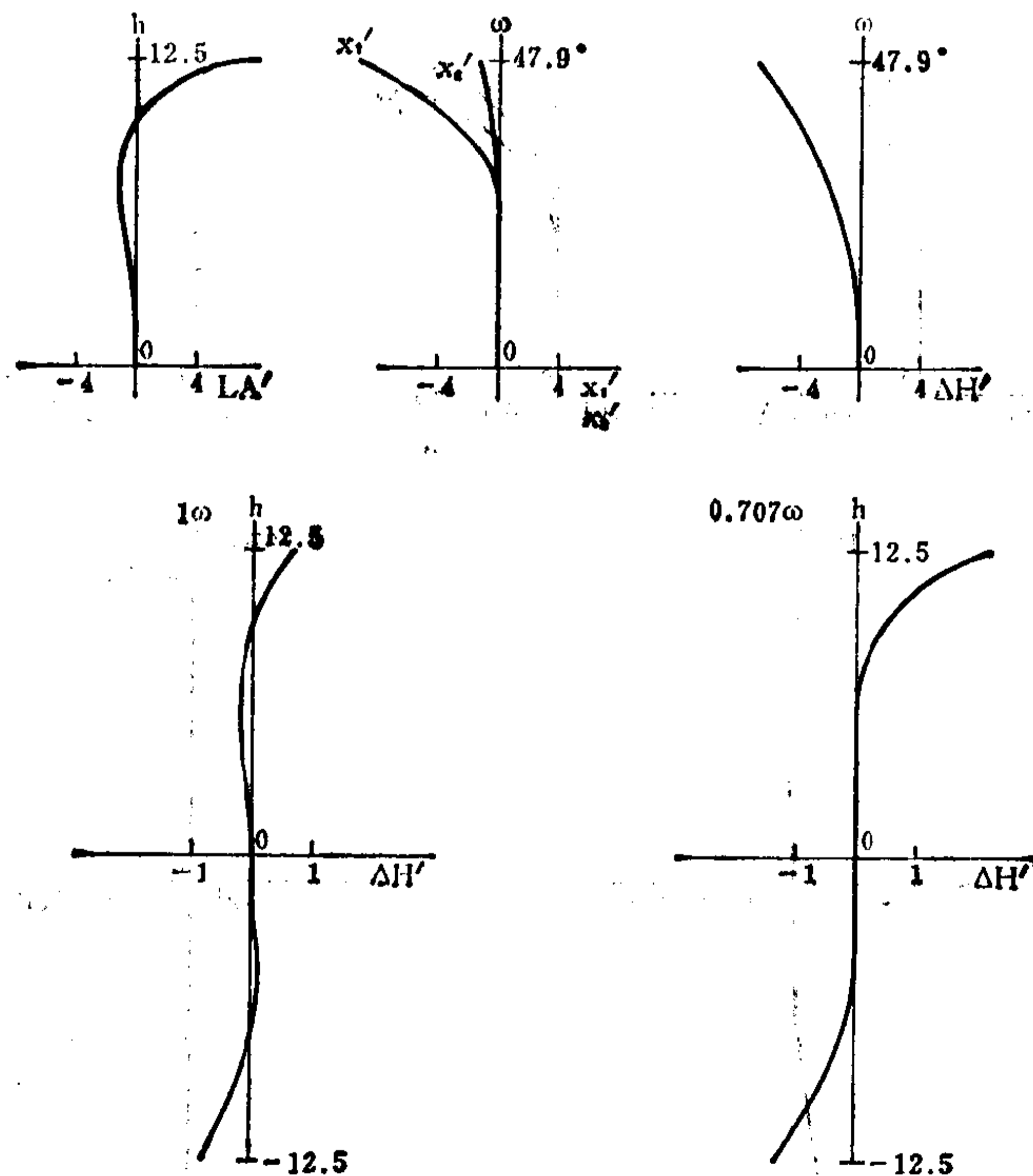

编号: 05-04-064

二级光谱较小的三透镜物镜

E.F.L=1.008

B.F.L=0.977

FNo.=6

F.A.=±25°**

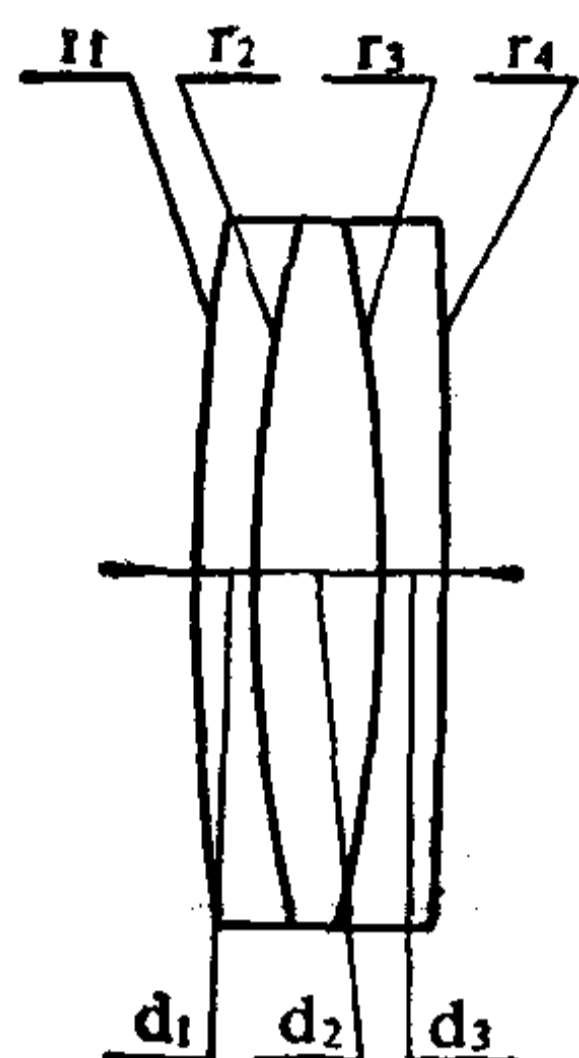

序号	r	d	nc	vc	序号	r	d	nc	vc
1	0.514160	0.012*	1.67245	45.8	3	-0.320041	0.012	1.57125	55.8
2	0.320041	0.025	1.54408	73.0	4	-3.373780			

$$0.012^* = 0.000 + 0.012$$

	ΣS_1	ΣS_2	ΣS_3	ΣS_4	ΣS_5	HI	QP(1 ω)
	-0.0000051	0.0000025	-0.0012139	-0.0008802	-0.0001311	0.47	-0.21%
h 或 ω %	LA'	$\Delta H'$	x'_i	x'_o	$x'_i - x'_o$	K'_{T1}	$K'_{T0.7}$
100	0.0001115	-0.000990	-0.299	-0.151	-0.148	0.001104	0.000590
70	-0.0000698	-0.000326	-0.161	-0.078	-0.083	0.000272	0.000158

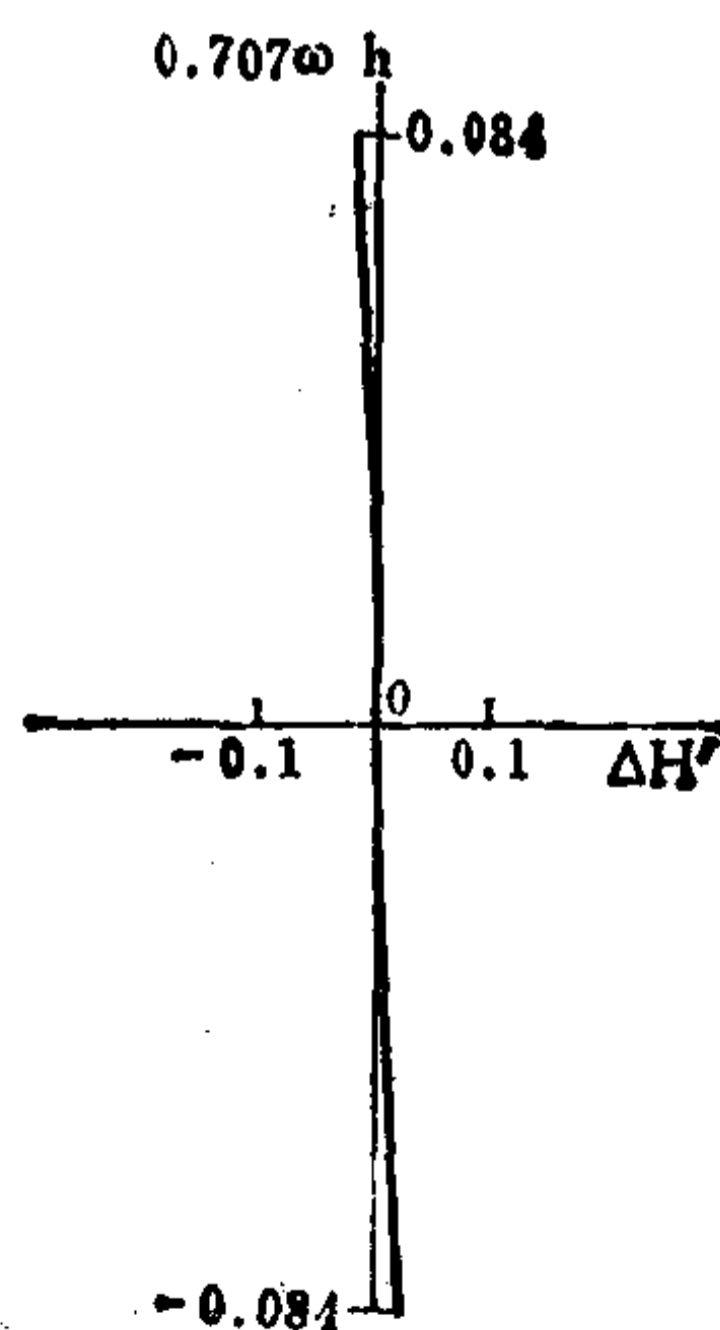
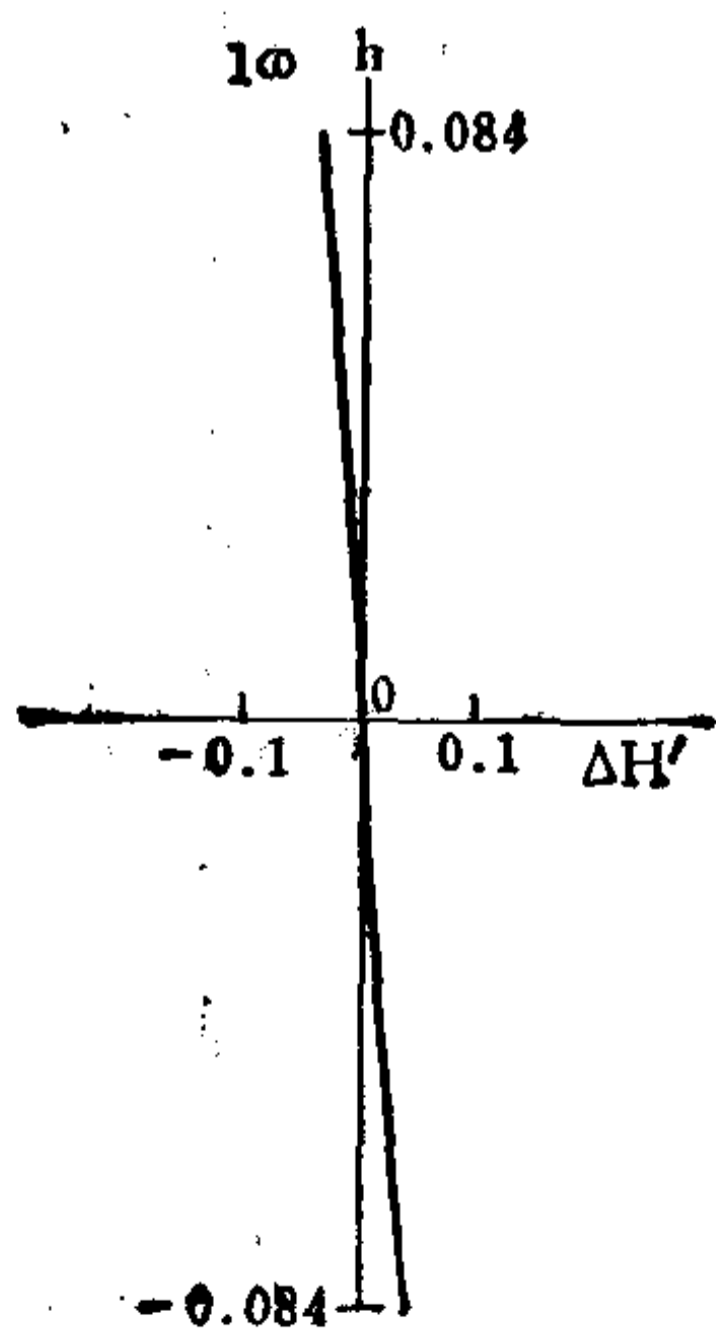
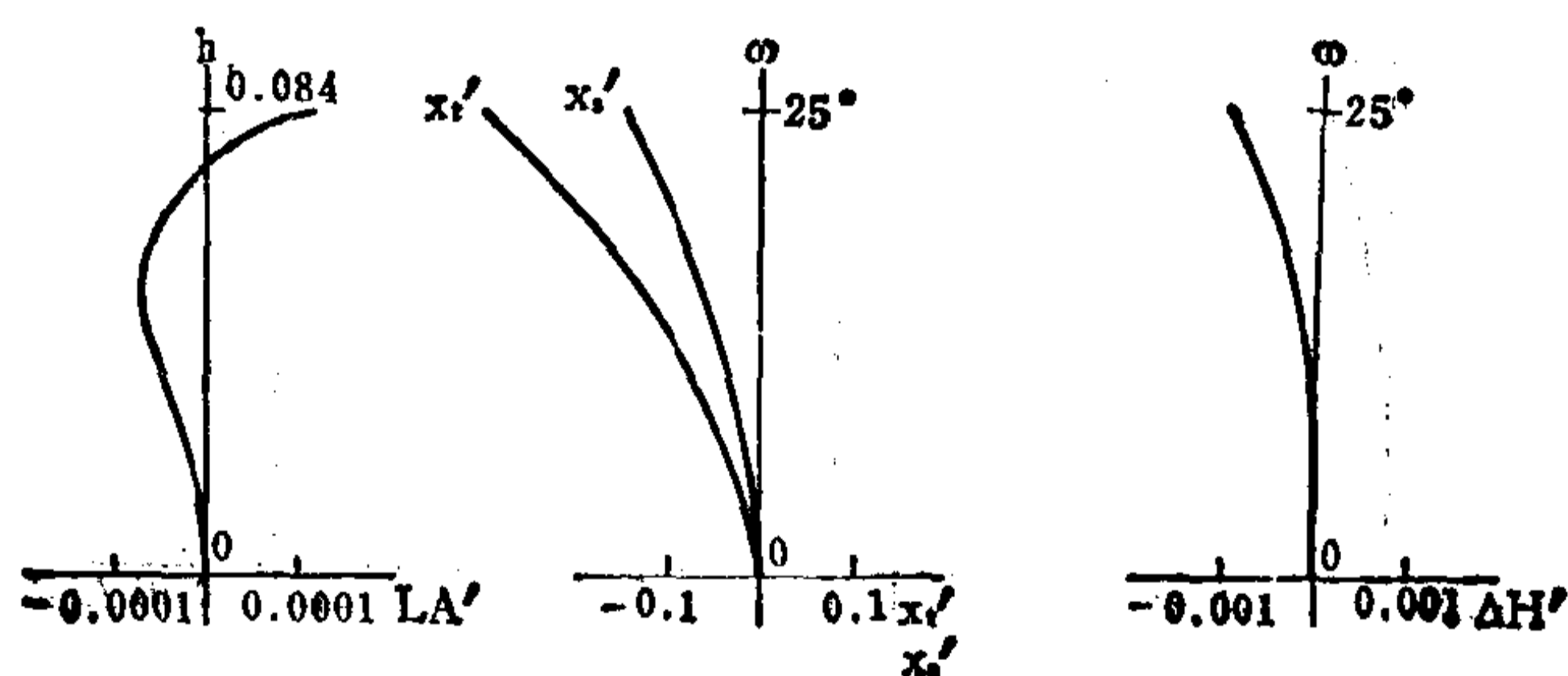

编号: 05-04-065

用于近紫外的透镜系统

E.F.L=9.93

B.F.L=6.62

FNo.=5.56

F.A.=±11°~±18°

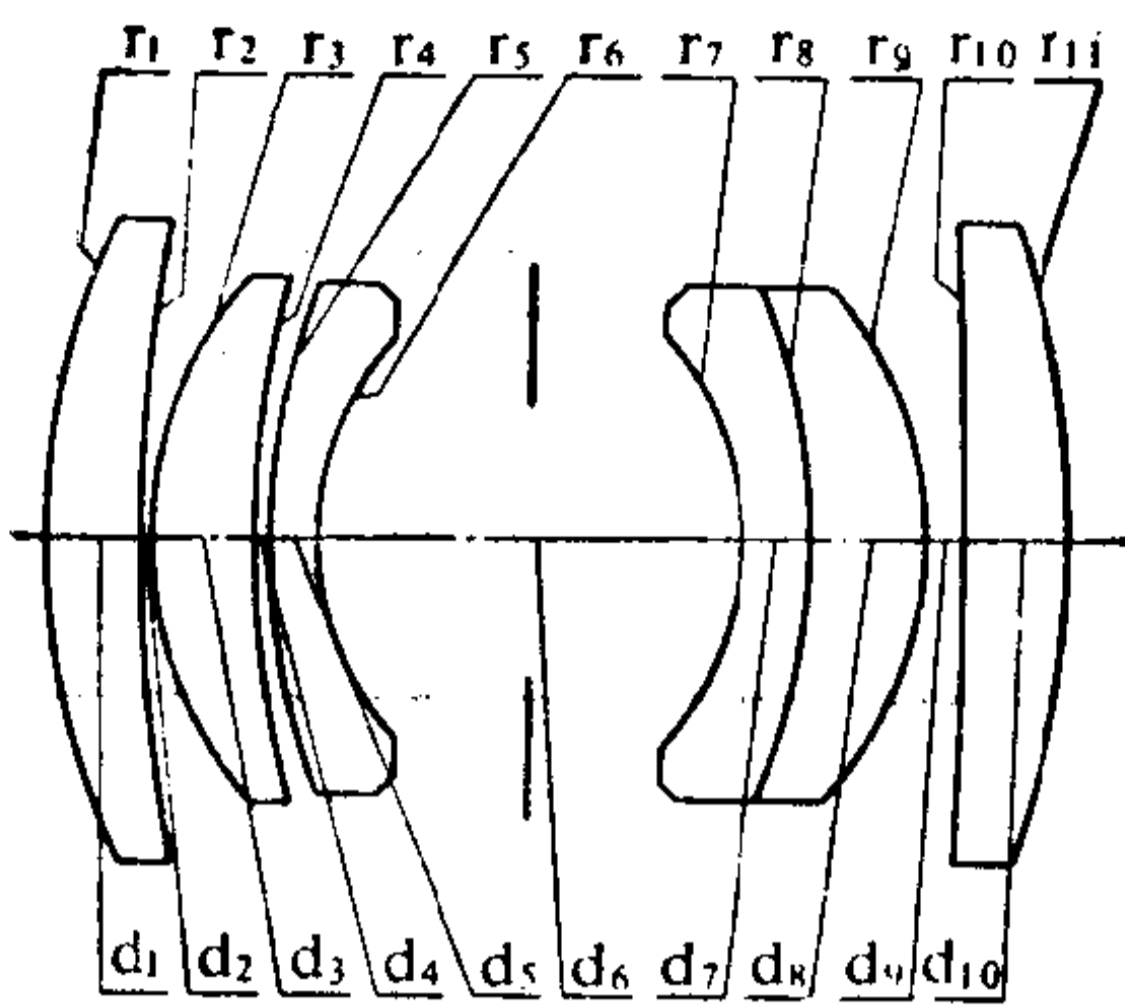

序号	r	d	n _D	v _D	序号	r	d	n _D	v _D
1	4.092	0.570	1.5170	64.5	6	1.601	2.246*		
2	10.298	0.016 ~0.253			7	-1.634	0.349	1.5725	42.5
3	2.173	0.546	1.5170	64.5	8	-3.838	0.650	1.5170	64.5
4	5.440	0.082			9	-2.138	0.201		
5	3.951	0.272	1.5725	42.5	10	-44.823	0.582	1.5170	64.5
					11	-5.108			

2.246* = 1.123 + 1.123

	ΣS ₁	ΣS ₂	ΣS ₃	ΣS ₄	ΣS ₅	HI	QP(1ω)
	0.000406	-0.000476	-0.000208	-0.000507	0.001253	1.9	0.38%
h 或 ω %	LA'	ΔH'	x _t	x _s	x _t - x _s	K _{T1}	K _{10.7}
100	0.0335	0.0073	-0.0773	-0.0445	-0.0328	-0.00758	-0.00362
70	0.0146	0.0025	-0.0375	-0.0225	-0.0150	-0.00577	-0.00274

注: 1. M = 1*~0.25*, F.A. = ±11°~±18°;

2. 以上象差值是按 d₂ = 0.016 计算的;

3. λ = 3600~4400 Å.

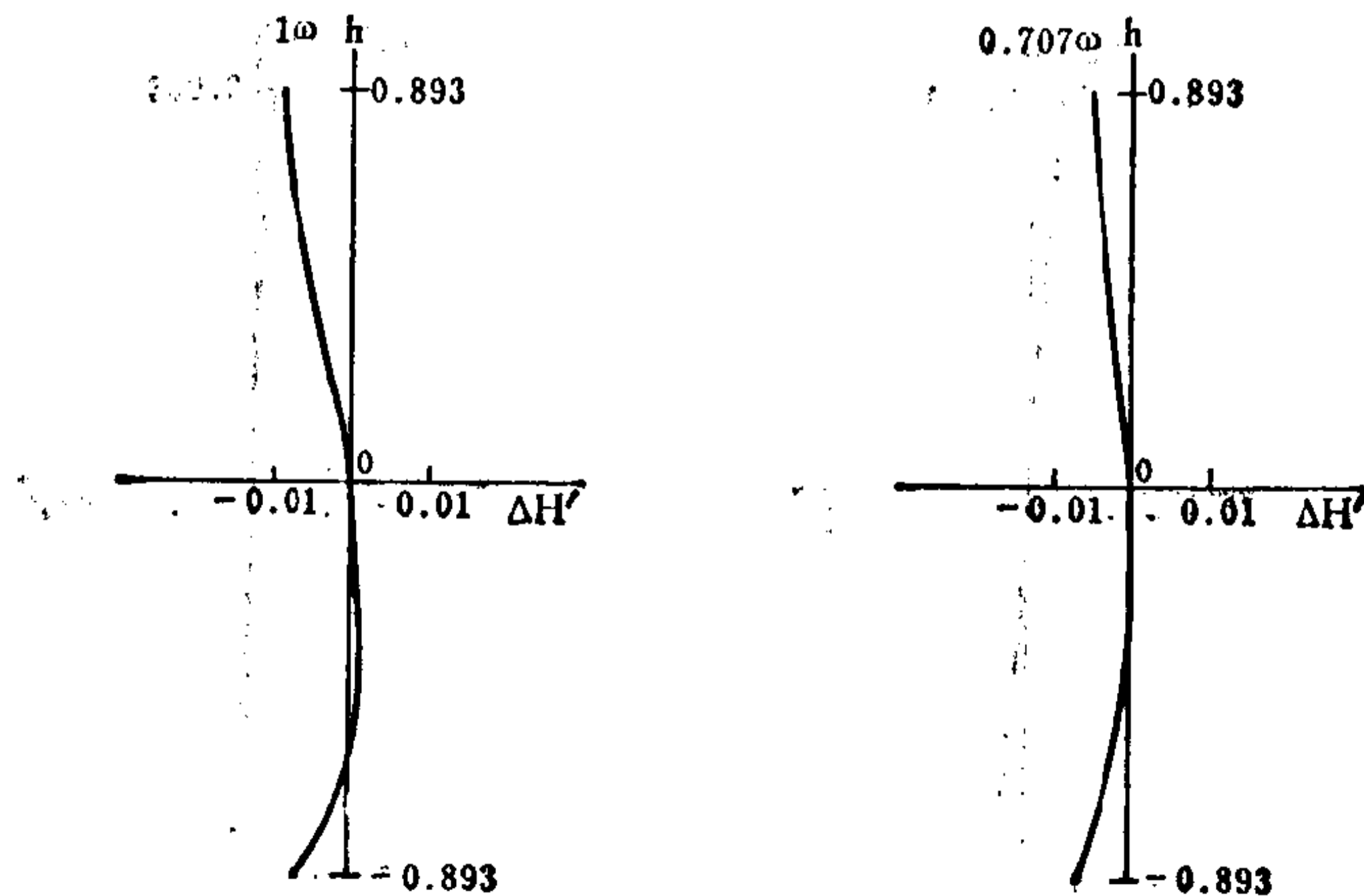
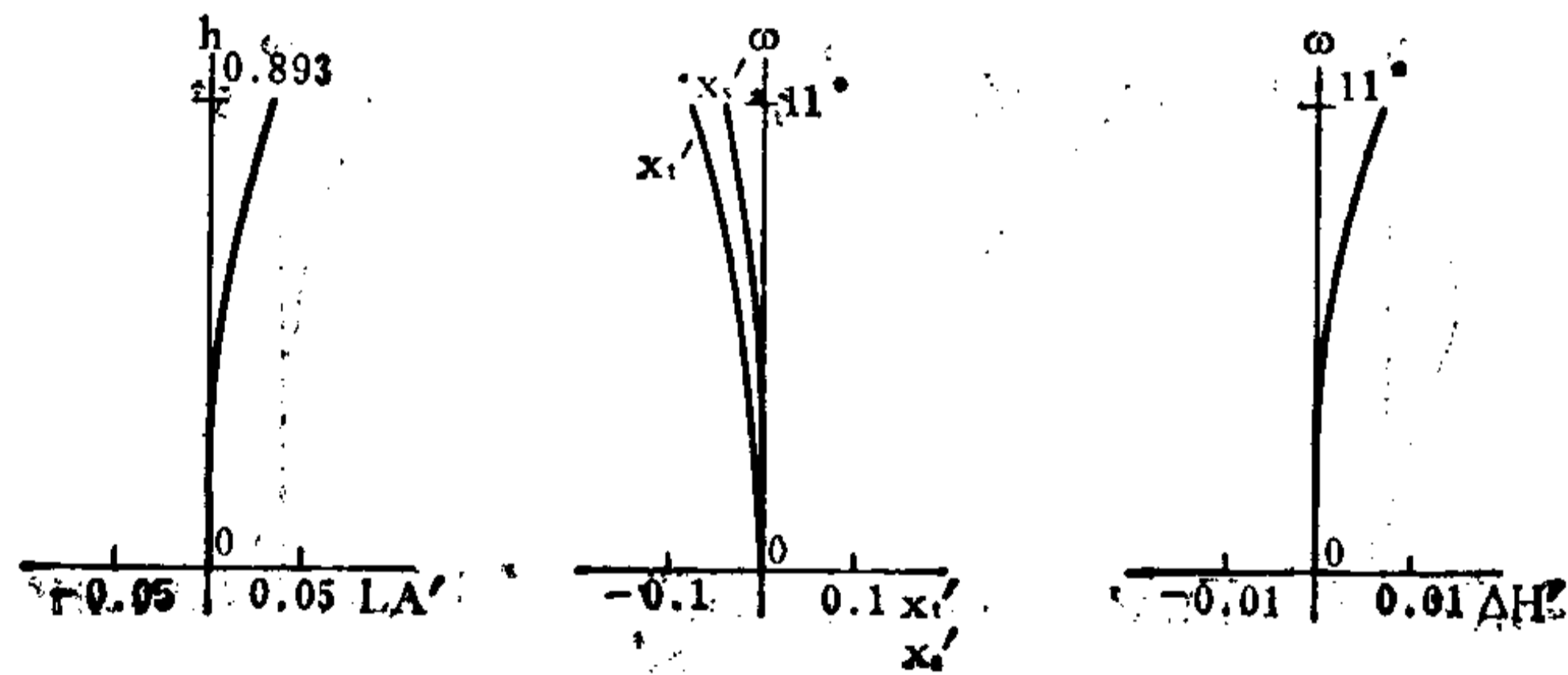

编号: 05-04-066

大孔径远距离照相镜头

E.F.L=84.992

B.F.L=42.327

FNo.=2.81

F.A.=±20°**

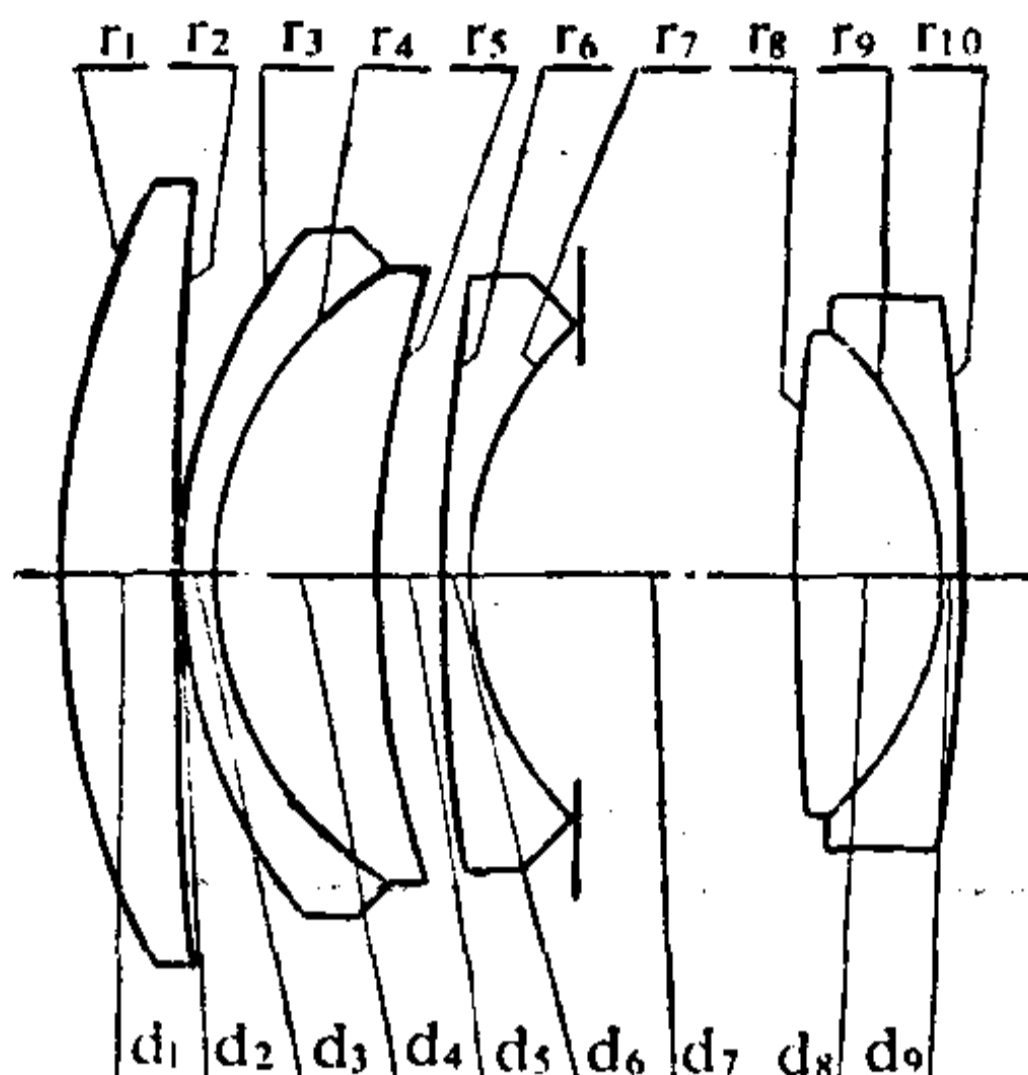

序号	r	d	n	v	序号	r	d	n	v
1	47.415	6.24	1.65100	56.15	6	119.915	1.40	1.80518	25.43
2	382.376	0.15			7	18.538	17.50*		
3	29.457	1.80	1.60311	60.70	8	125.044	7.60	1.69700	48.51
4	19.612	8.87	1.69100	54.84	9	-17.176	0.90	1.62299	58.14
5	53.405	3.60			10	-122.866			

17.50* = 5.00 + 12.50

	ΣS_1	ΣS_2	ΣS_3	ΣS_4	ΣS_5	HI	QP (1 ω)
	-0.01519	0.00067	0.01524	-0.04543	0.31837	31	2.1%
h 或 ω %	LA'	$\Delta H'$	x'_t	x'_s	$x'_t - x'_s$	K_{T1}	$K'_{T0.7}$
100	-0.0670	0.6689	-1.0797	0.6784	-1.7581	-0.76448	-0.15946
70	-0.0768	0.3039	0.0095	0.0044	0.0051	-0.02678	-0.00165

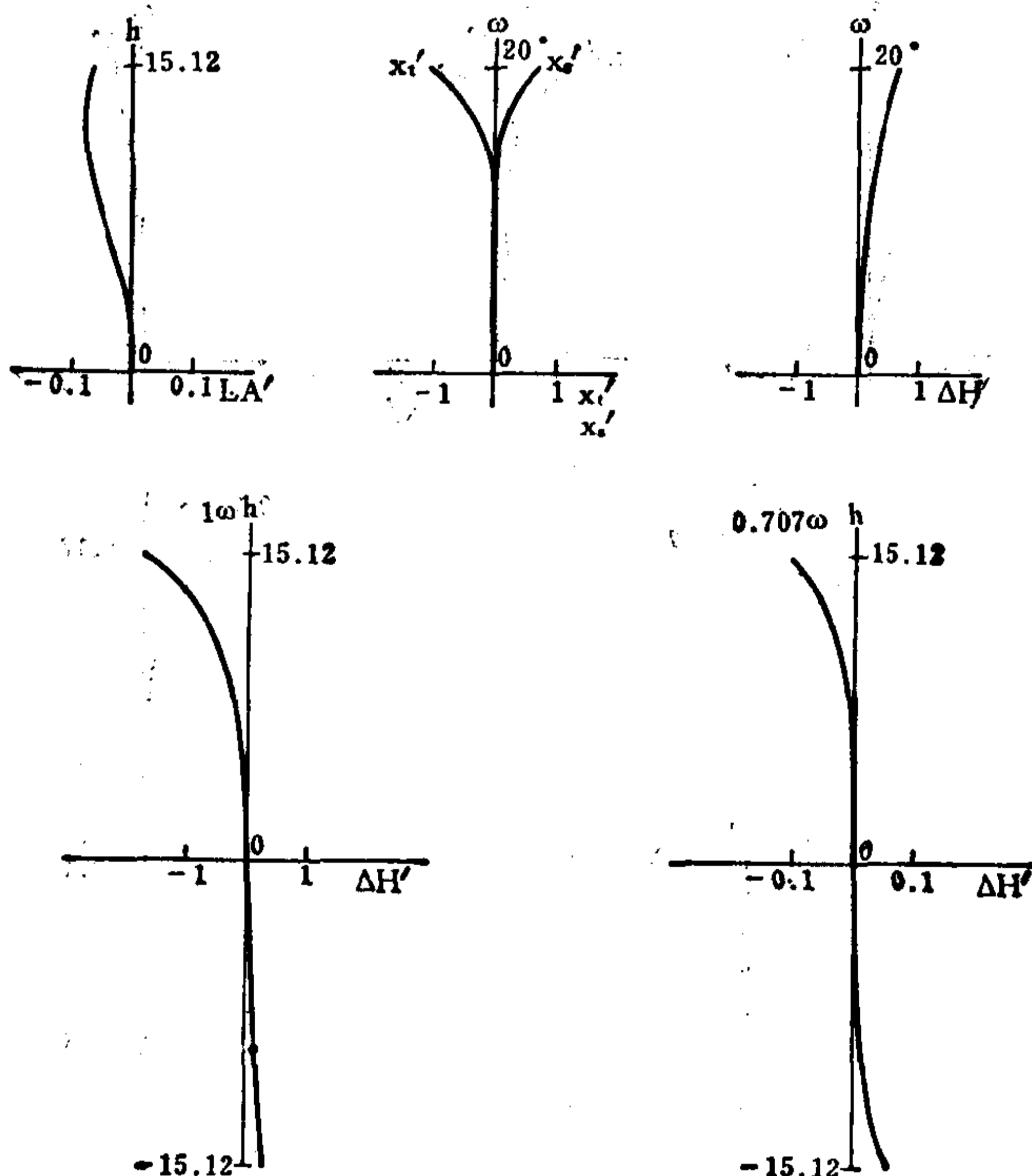

编号: 05-04-067

大孔径远距离照相镜头

E.F.L=85.016

B.F.L=41.621

FNo.=2.8

F.A.=±20°**

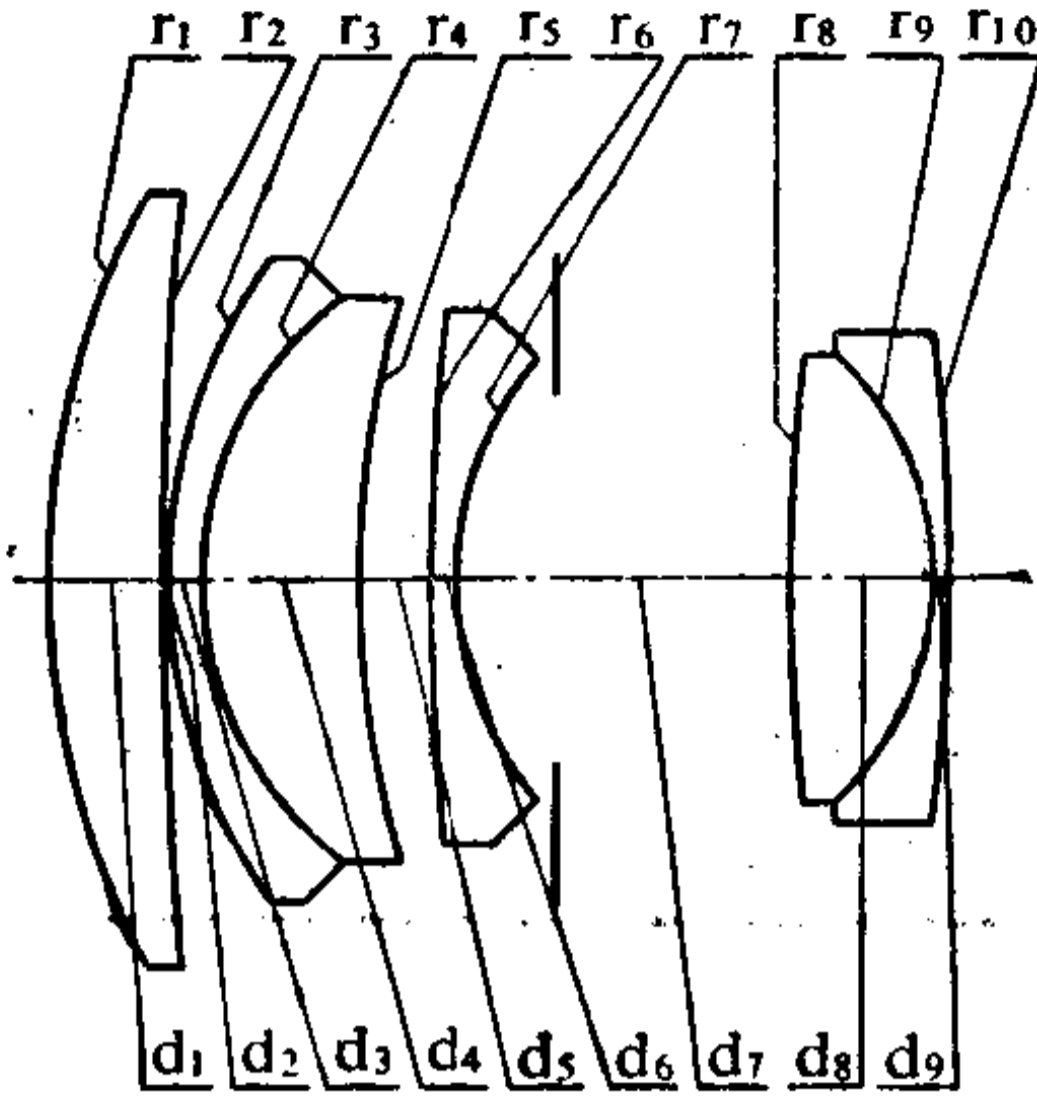

序号	r	d	n	v	序号	r	d	n	v
1	44.137	6.28	1.65100	56.15	6	128.926	1.40	1.78470	26.22
2	281.551	0.15			7	18.636	17.78*		
3	30.563	1.80	1.61272	58.75	8	103.353	7.60	1.67790	50.72
4	19.458	8.87	1.69680	56.51	9	-16.802	0.90	1.62041	60.27
5	53.203	3.60			10	-129.614			

17.78* = 5.00 + 12.78

	ΣS_1	ΣS_2	ΣS_3	ΣS_4	ΣS_5	HI	QP(1 ω)
	-0.01563	0.00334	0.01410	-0.04771	0.29069	31	1.4%
h 或 ω %	LA'	$\Delta H'$	x_t	x_s	$x_t - x_s$	K'_{T1}	$K'_{T0.7}$
100	-0.06984	0.4320	-1.0426	0.6839	-1.7265	-1.36548	-0.23047
70	-0.07926	0.2533	0.0172	-0.0048	0.0220	-0.05324	-0.00466

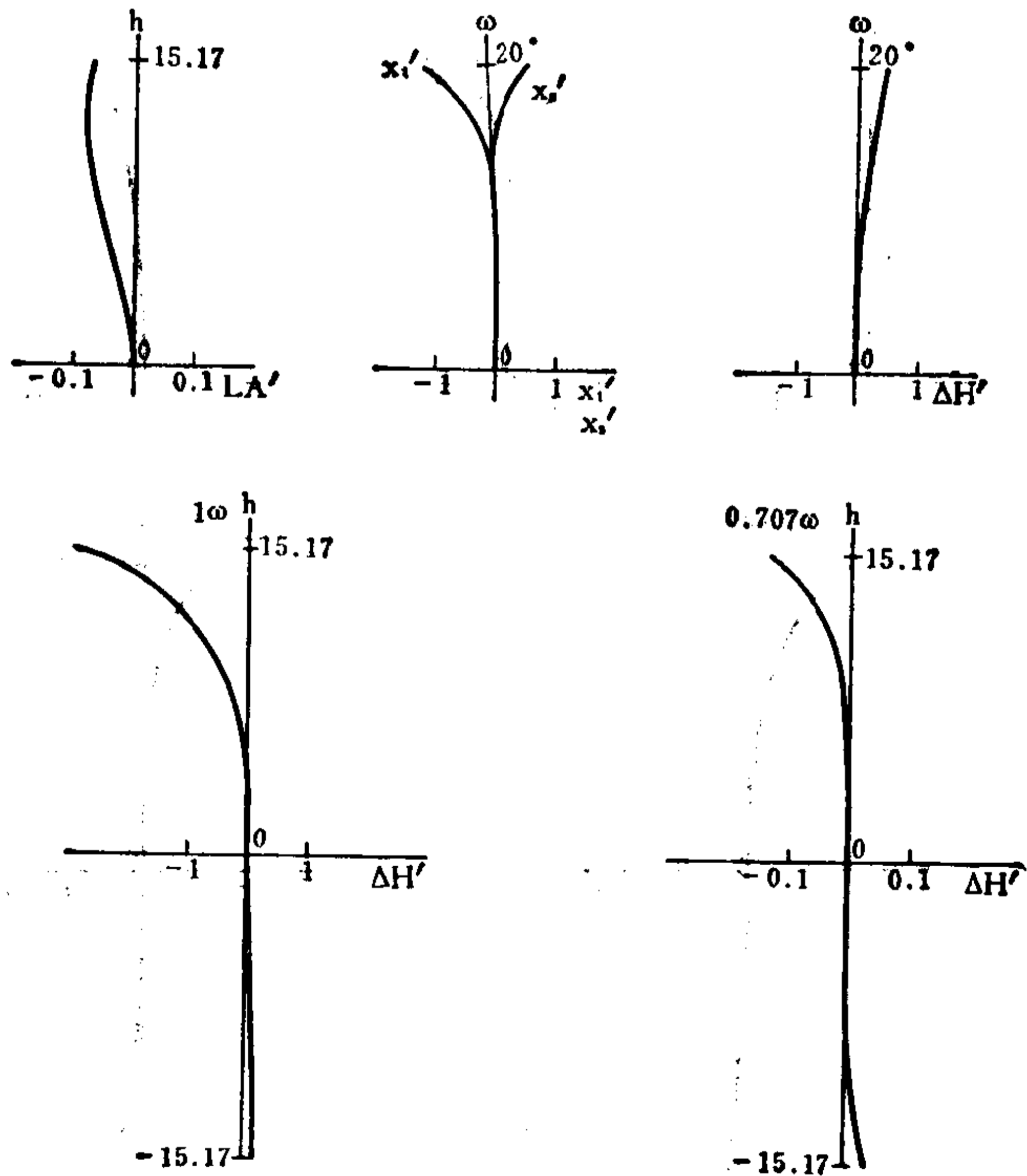

编号: 05-04-068

长焦距透镜系统

E.F.L = 1000.99

B.F.L = 616.65

FNo. = 4

F.A. = ± 10°

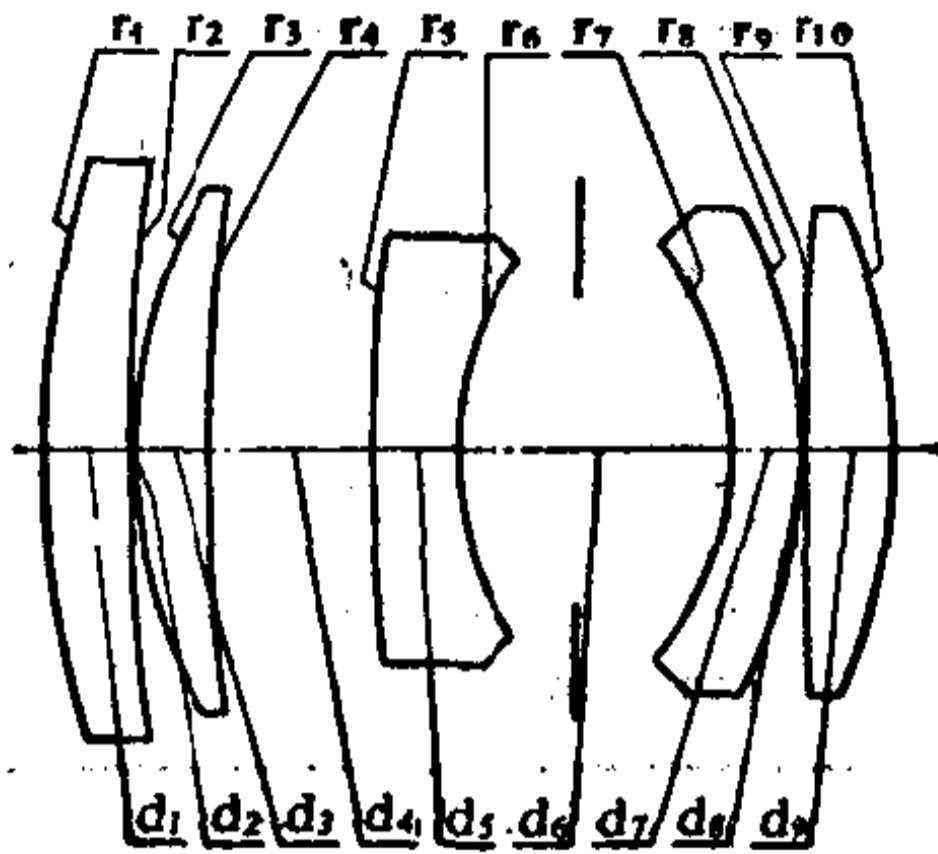

序号	r	d	n _d	v _d	序号	r	d	n _d	v _d
1	634.300	54.68	1.64000	60.2	6	221.643	175.00*		
2	2007.820	1.99			7	-215.442	43.74	1.54814	45.9
3	345.582	50.00	1.64000	60.2	8	-338.465	5.01		
4	1215.569	103.89			9	5691.000	55.01	1.75700	47.7
5	1931.321	55.01	1.76182	26.5	10	-391.378			

175.00* = 75.00 + 100.00

	ΣS ₁	ΣS ₂	ΣS ₃	ΣS ₄	ΣS ₅	HI	QP (1ω)
	-0.0683	0.0022	0.0343	-0.0383	0.0033	176.5	-0.04%
h 或 ω %	LA'	ΔH'	x' _i	x' _s	x' _i - x' _s	K' _{T1}	K' _{T0.7}
100	-1.4990	-0.0763	1.5146	0.4235	1.0911	-0.3088	-0.0524
70	-0.9223	-0.0094	0.9266	0.0718	0.8548	-0.2413	-0.0474

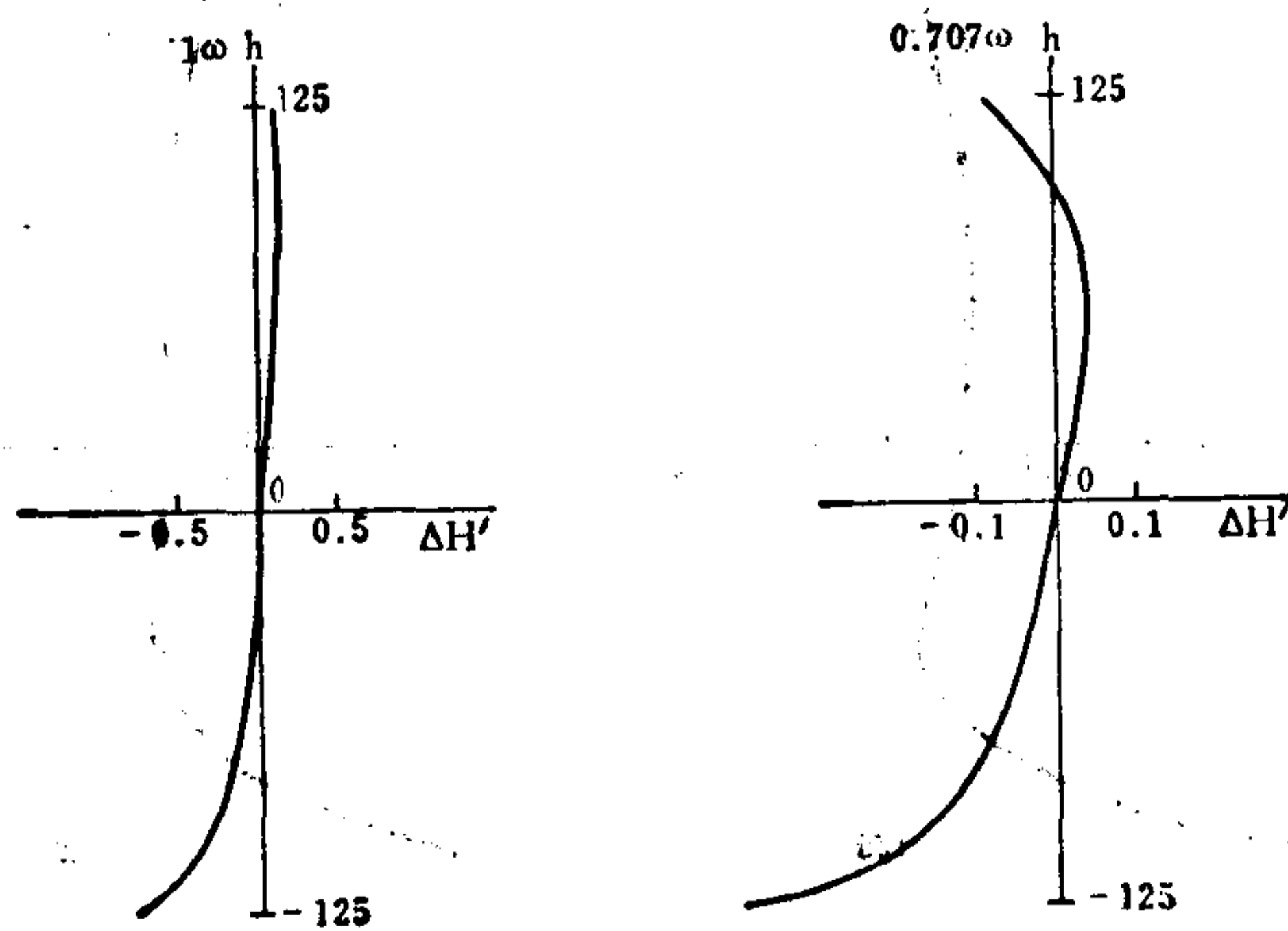
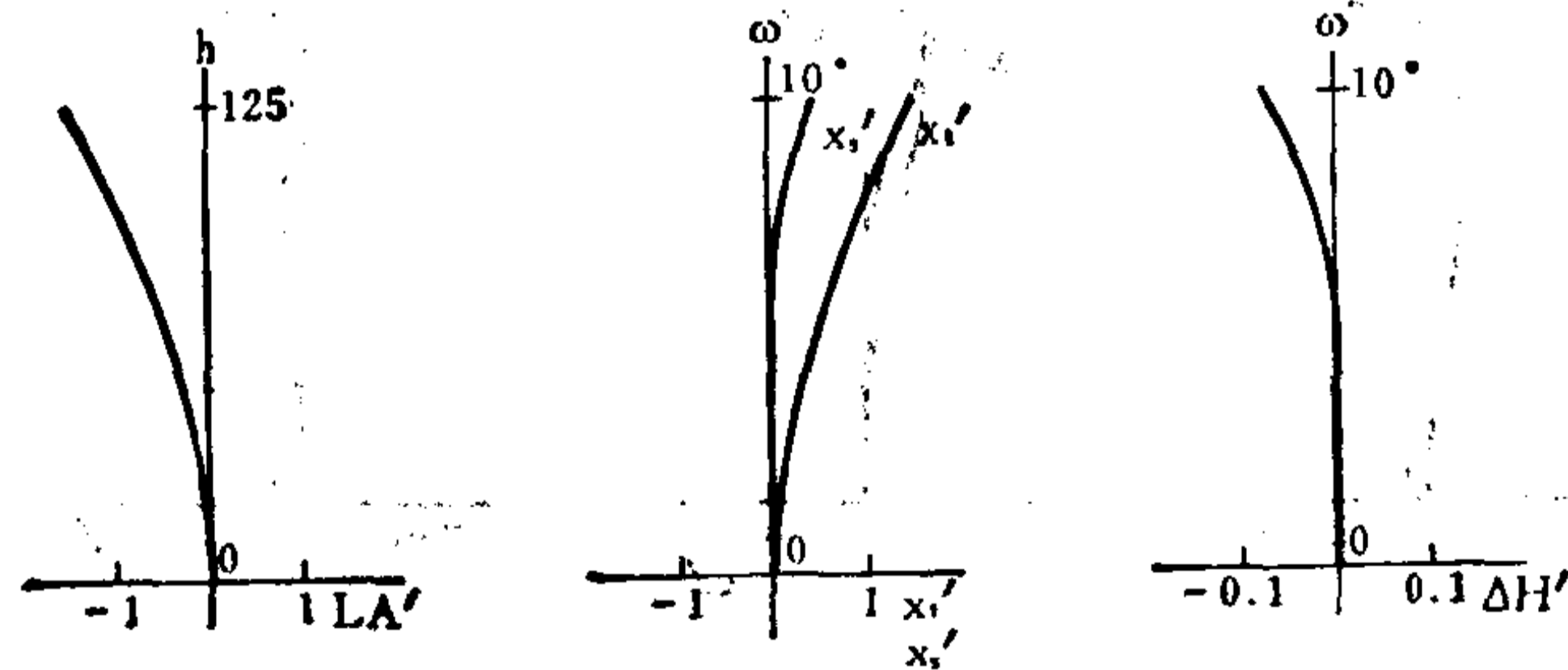

编号: 05-04-069

长焦距透镜系统

E.F.L = 1000

B.F.L = 586.01

FNo. = 4

F.A. = ± 10°

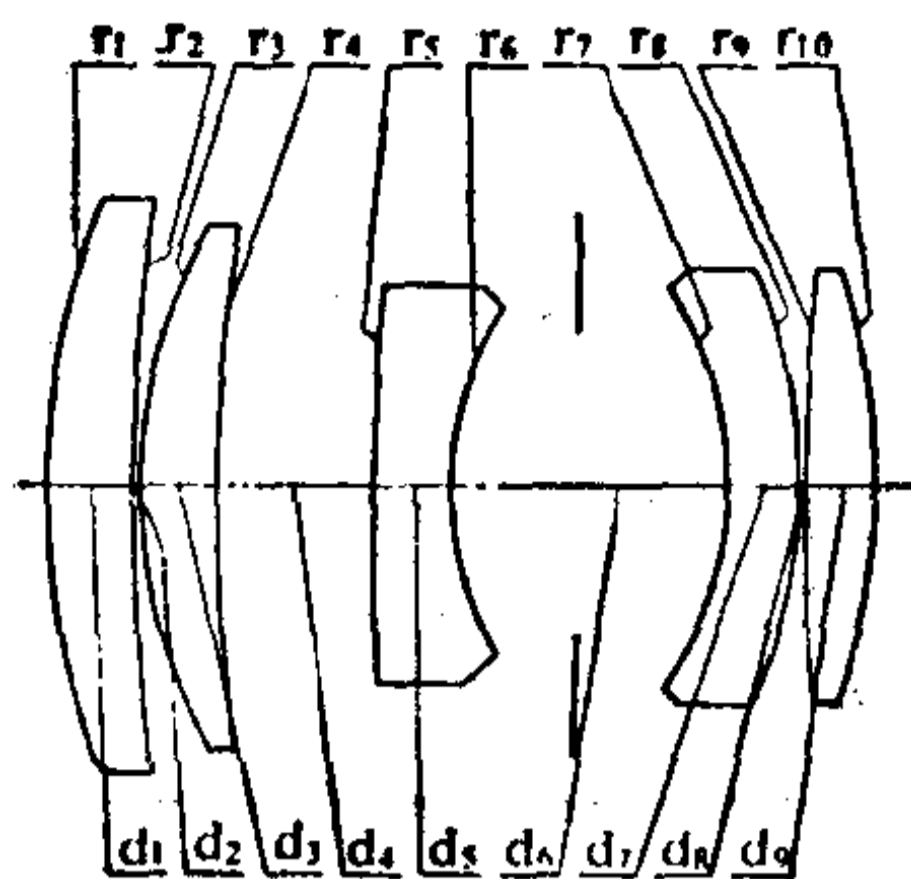

序号	r	d	n _d	v _d	序号	r	d	n _d	v _d
1	513.998	55.01	1.64000	60.2	6	224.189	174.98*		
2	1365.181	1.97			7	-235.127	43.74	1.53172	43.9
3	356.518	48.99	1.64000	60.2	8	-371.879	5.01		
4	1338.771	100.61			9	2187.227	43.74	1.74320	49.3
5	2996.500	51.99	1.74077	27.7	10	-453.395			

* 174.98* = 74.98 + 100.00

	ΣS ₁	ΣS ₂	ΣS ₃	ΣS ₄	ΣS ₅	HI	QP (1ω)
	-0.0382	0.0030	0.0178	-0.0531	0.0287	176.3	-0.006%
h 或 ω %	LA'	ΔH'	x _t '	x _s '	x _t ' - x _s '	K _{T1} '	K _{T0.7} '
100	-0.1620	-0.0114	-0.8053	-0.5805	-0.2248	-0.2071	0.0023
70	-0.3568	0.0194	-0.1608	-0.4309	0.2701	-0.2076	-0.0276

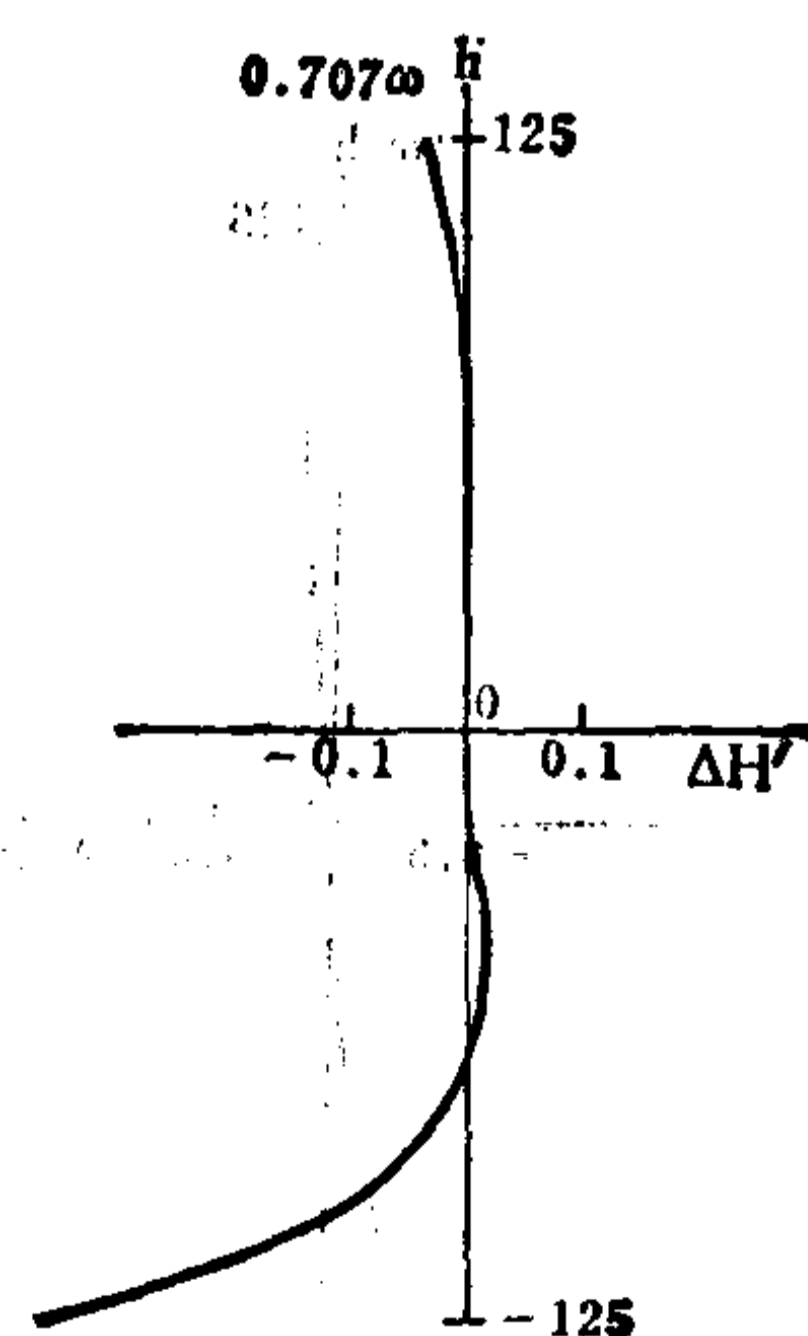
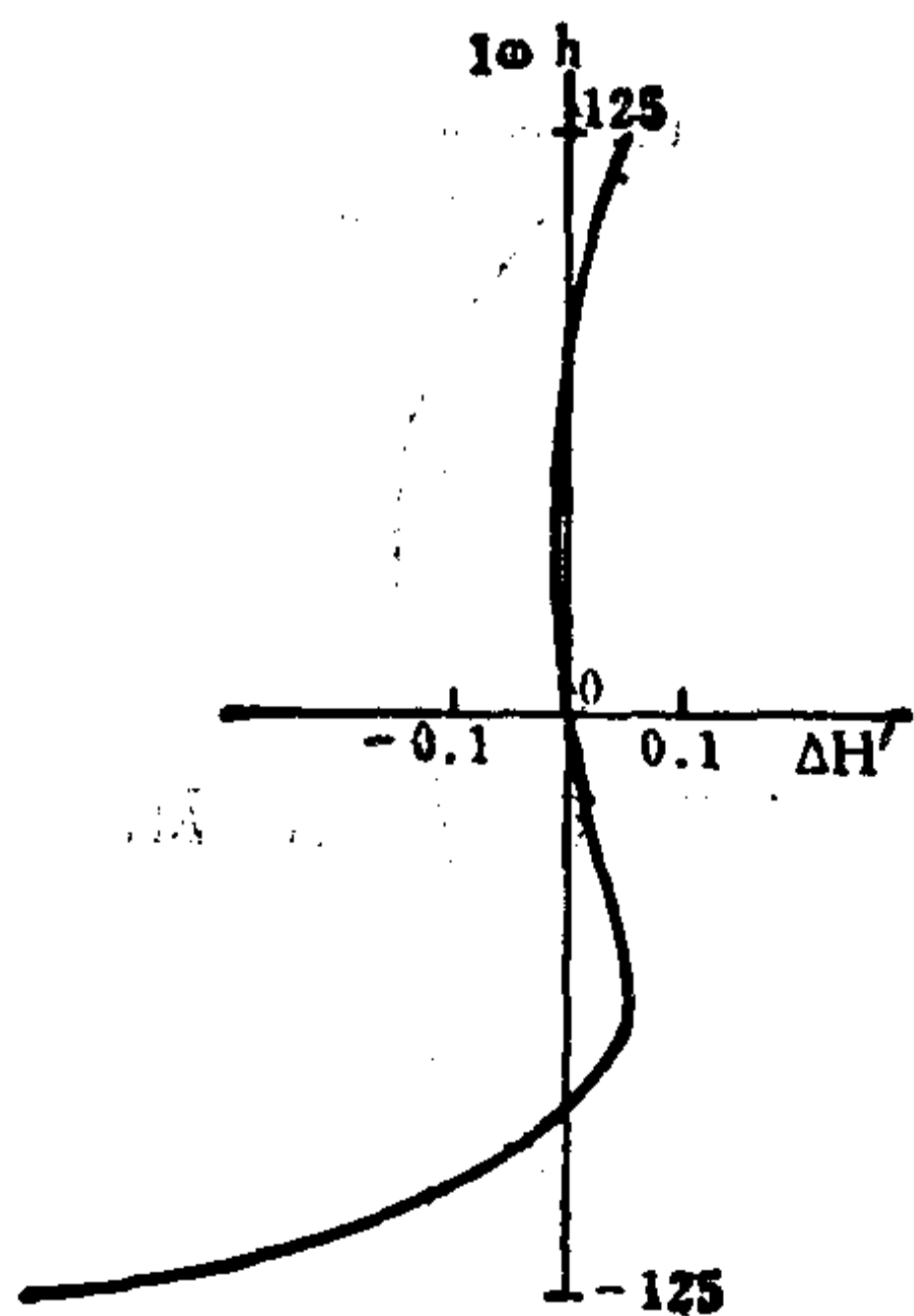
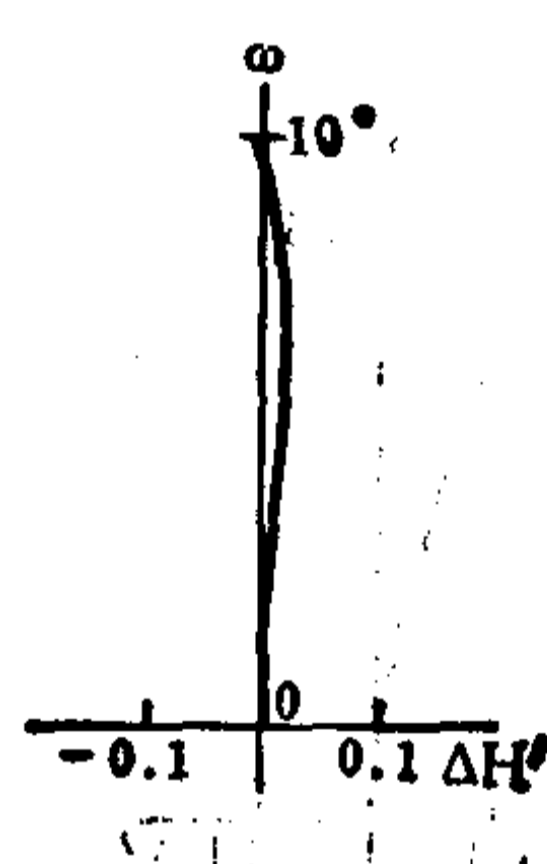
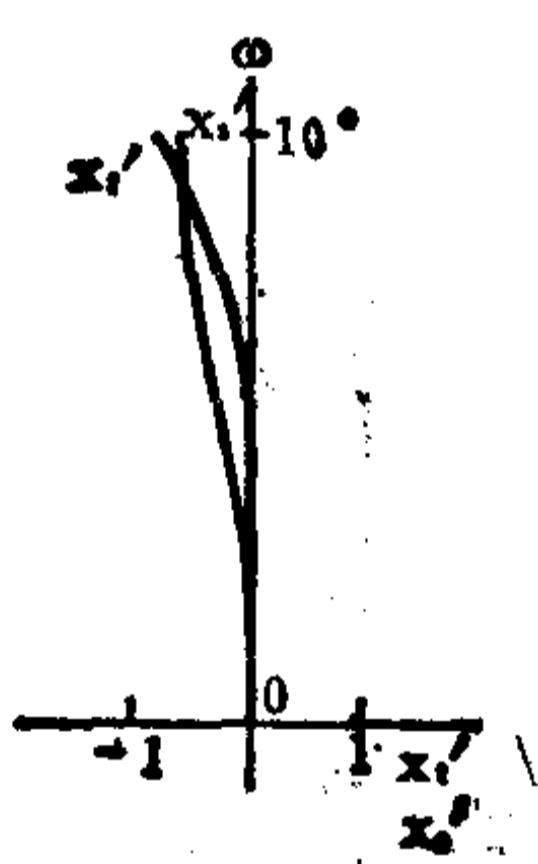
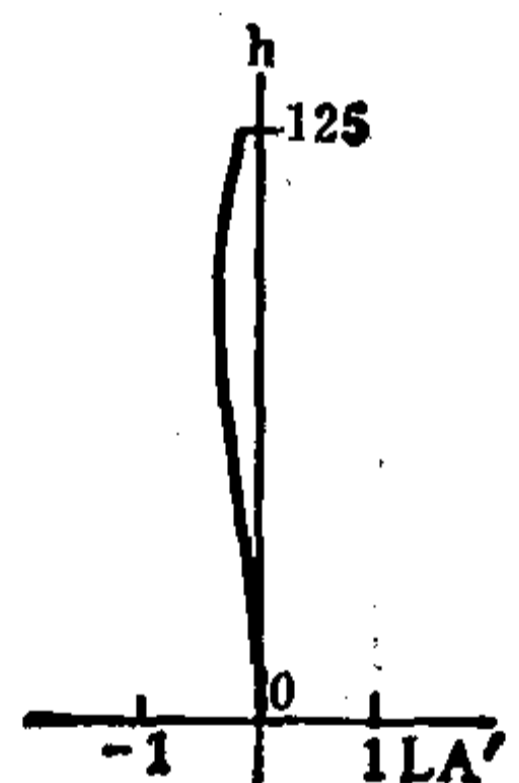

编号: 05-04-070

复消色差的对称广角物镜

E.F.L=97.19

B.F.L=89.15

FN₀. =14.6

F.A. = ±22.5°

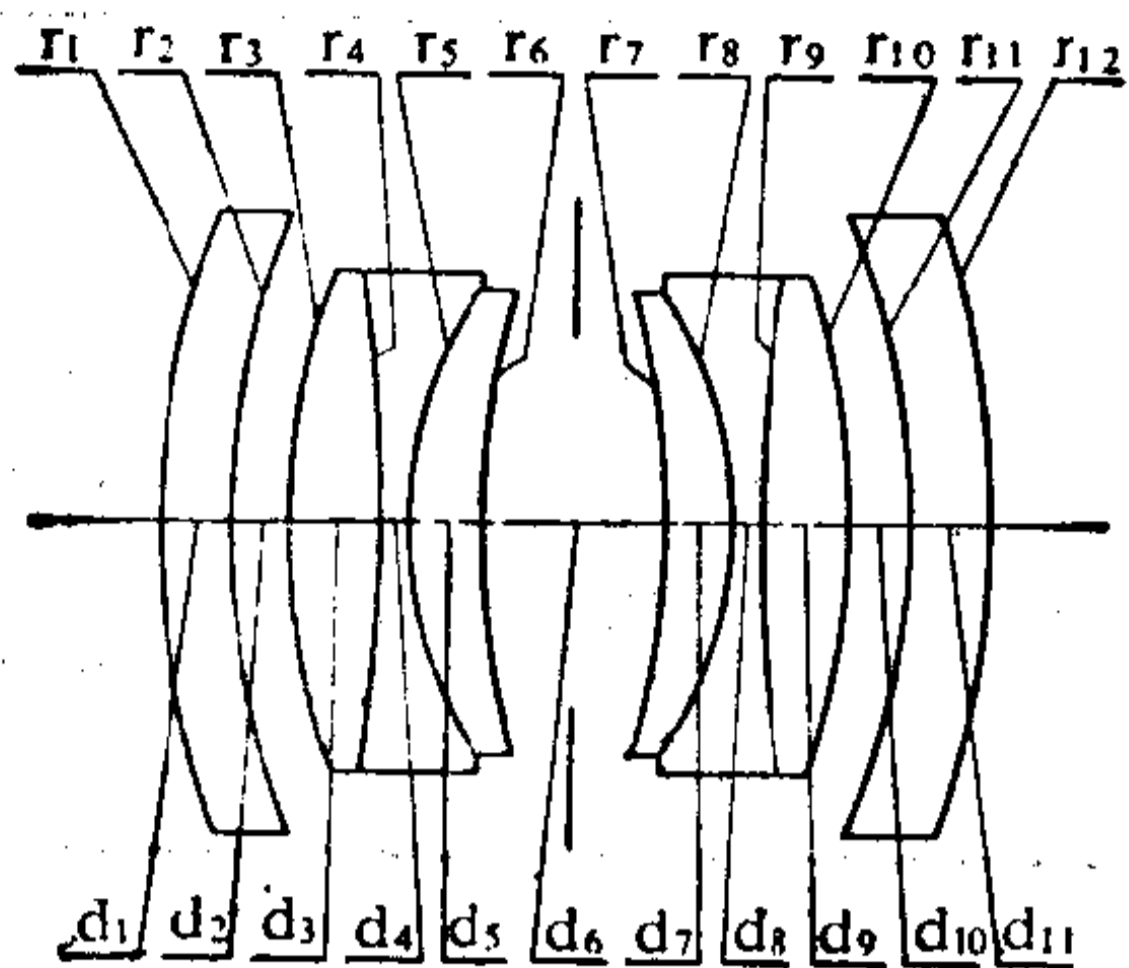

序号	r	d	n _e	v _e	序号	r	d	n _e	v _e
1	18.81	1.75	1.518	56.6	7	-18.13	1.43	1.466	65.7
2	18.71	1.22			8	-8.93	0.79	1.560	53.7
3	18.13	1.77	1.661	57.1	9	43.61	1.77	1.661	57.1
4	-43.61	0.79	1.560	53.7	10	-18.13	1.22		
5	8.93	1.43	1.466	65.7	11	-18.71	1.75	1.518	56.6
6	18.13	3.90*			12	-18.81			

3.90* = 1.95 + 1.95

	ΣS ₁	ΣS ₂	ΣS ₃	ΣS ₄	ΣS ₅	HI	QP (1ω)
	-0.00049	-0.00068	0.00014	-0.00199	0.00105	40.29	0.06%
h 或 ω %	LA'	ΔH'	x _t	x _s	x _t - x _s	K _{T1}	K _{T0.7}
100	-0.0907	0.0242	0.3308	0.0706	0.2602	-0.0404	-0.0189
70	-0.0765	0.0070	-0.0915	-0.2055	0.1140	-0.0267	-0.0125

注: 以上象差值是按 l = -∞ 计算的。

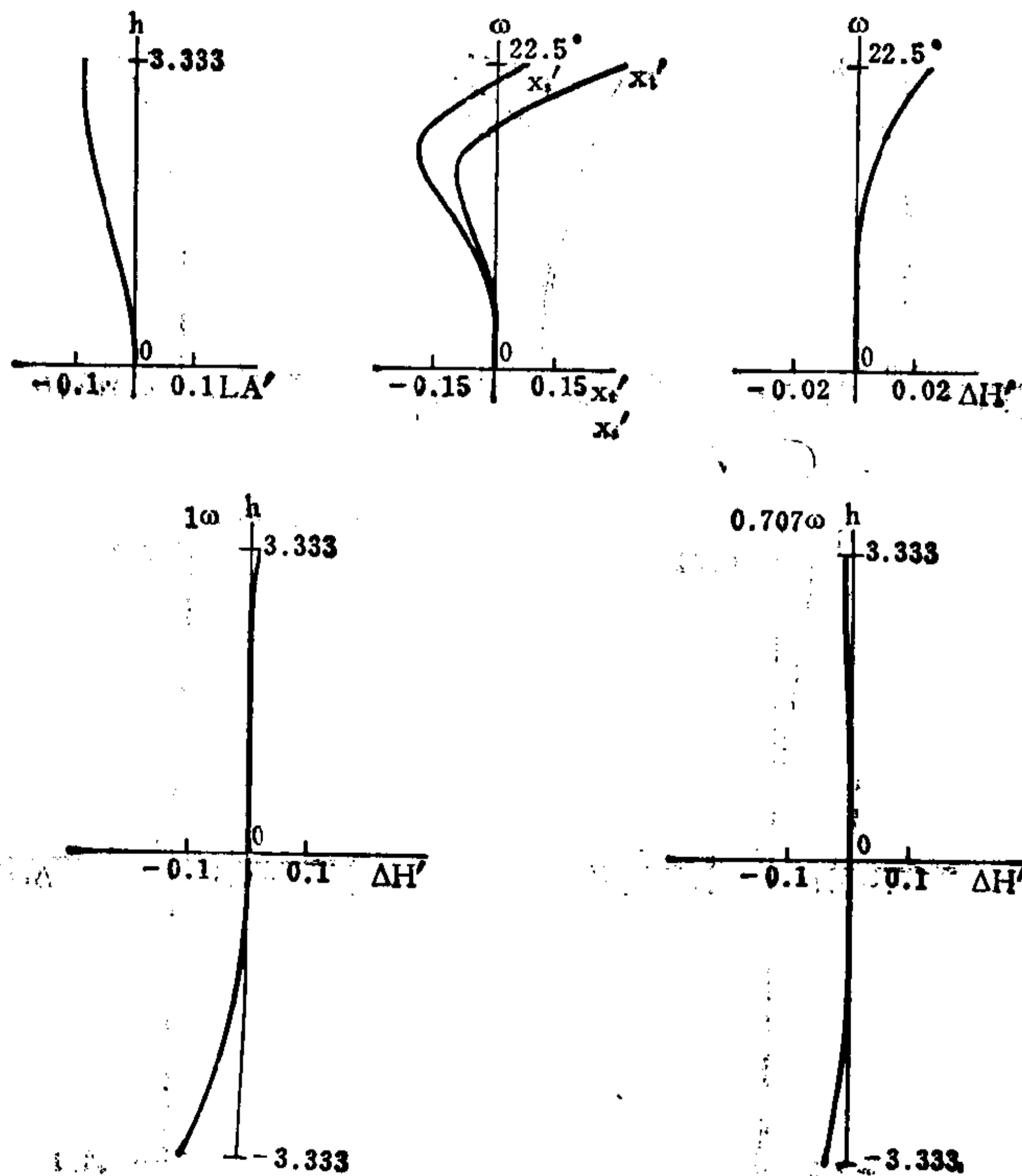

编号: 05-04-071

复消色差的对称广角物镜

E.F.L = 95.82

B.F.L = 88.29

FNo. = 14.4

F.A. = ±22.5°

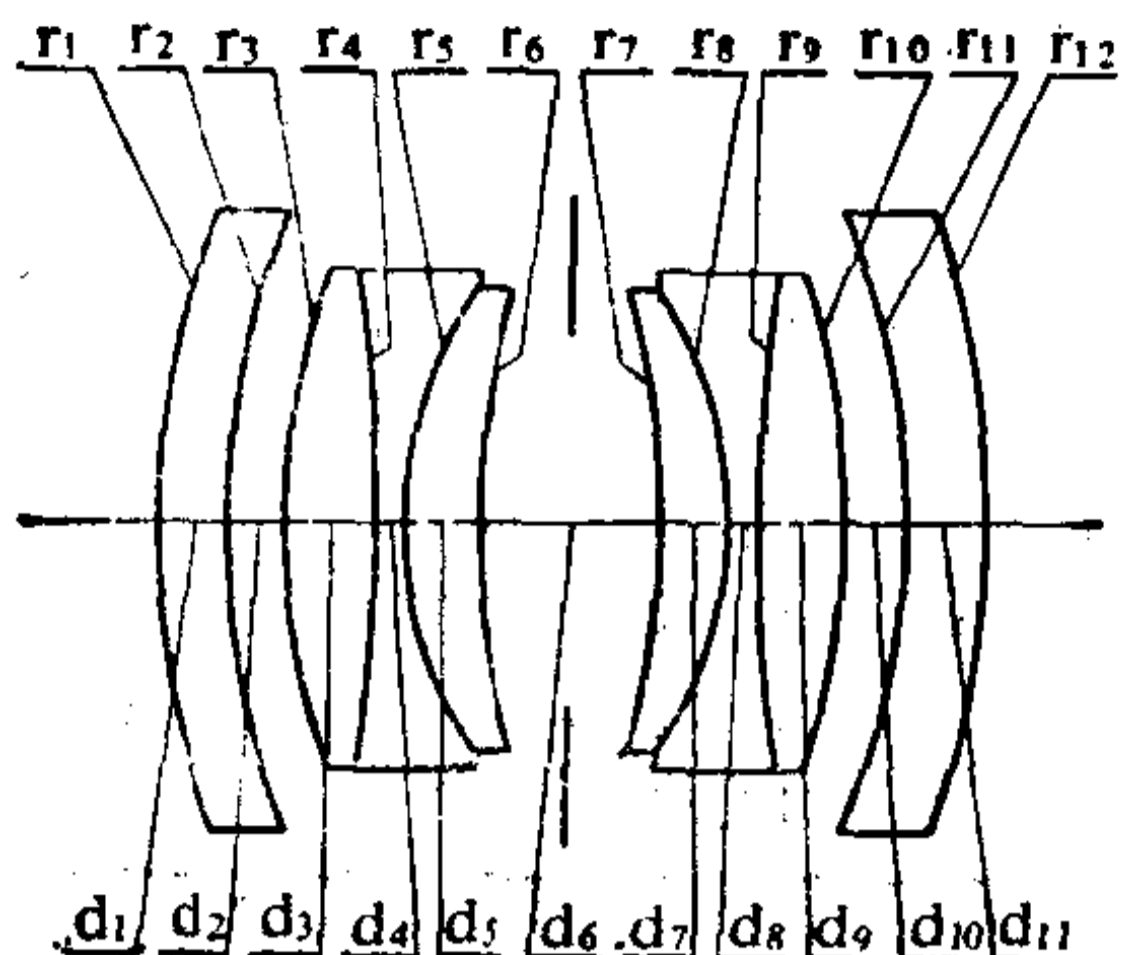

序号	r	d	n_e	v_e	序号	r	d	n_e	v_e
1	24.01	1.35	1.520	65.0	7	-15.26	1.43	1.517	54.5
2	21.28	1.22			8	-5.96	0.79	1.560	53.7
3	14.51	1.67	1.623	60.1	9	21.73	1.67	1.623	60.1
4	-21.73	0.79	1.560	53.7	10	-14.51	1.22		
5	5.96	1.43	1.517	54.5	11	-21.28	1.35	1.520	65.0
6	15.26	3.90*			12	-24.01			

3.90* = 1.95 + 1.95

	ΣS_1	ΣS_2	ΣS_3	ΣS_4	ΣS_5	HI	QP (1 ω)
	-0.00072	-0.00072	0.00009	-0.00127	0.00085	39.7	0.05%
h 或 ω %	LA'	$\Delta H'$	x'_i	x'_e	$x'_i - x'_e$	K'_{T1}	$K'_{T0.7}$
100	0.5727	0.0205	-0.2565	0.3381	-0.5946	-0.0216	-0.0126
70	0.0420	0.0058	-0.1184	-0.0558	-0.0626	-0.0197	-0.0105

注: 以上象差值是按 $l = -\infty$ 计算的。

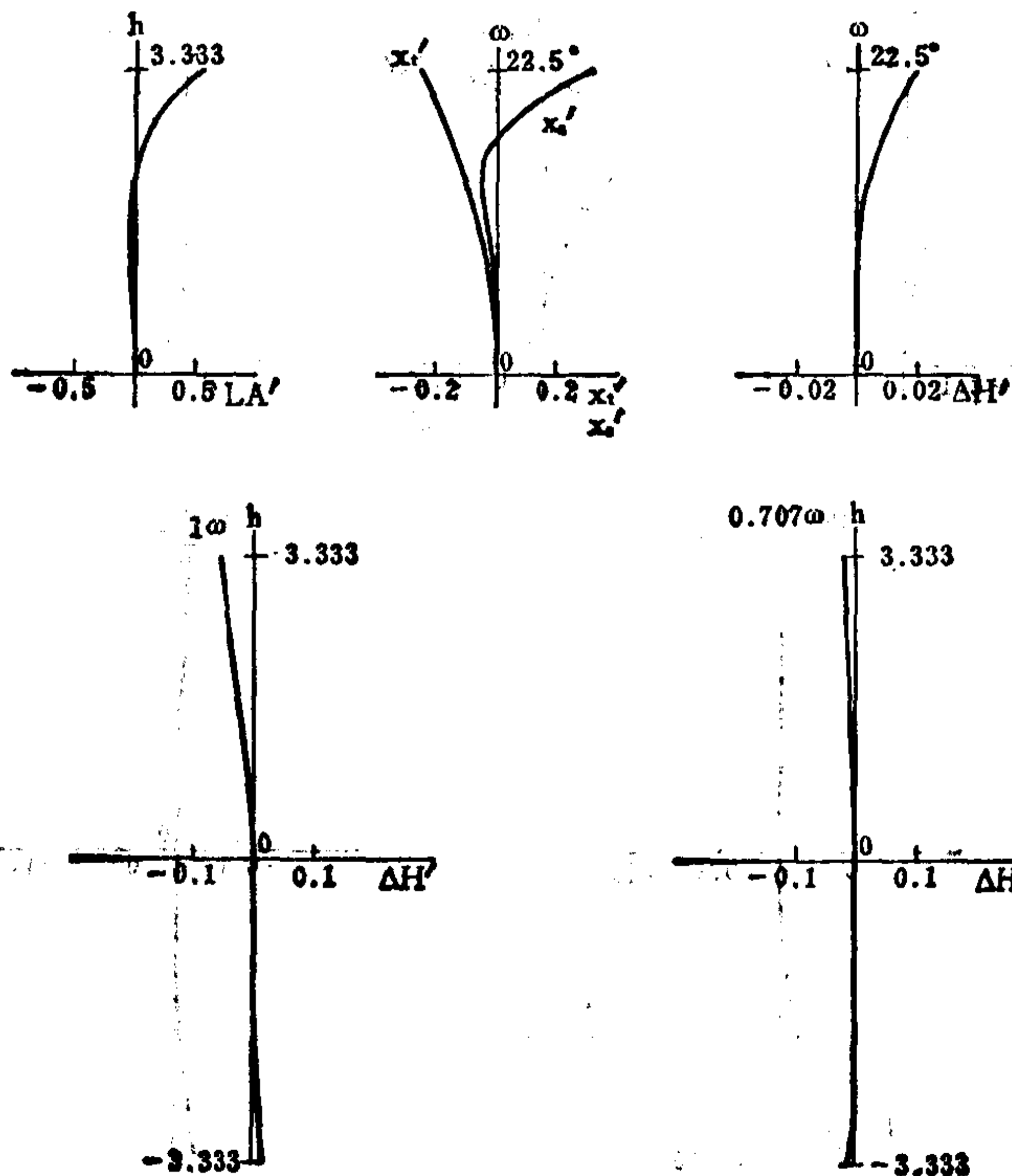

编号: 05-04-072

五组元摄影物镜

E.F.L=1.0

B.F.L=0.8317

FNo.=5.6

F.A.=±15°

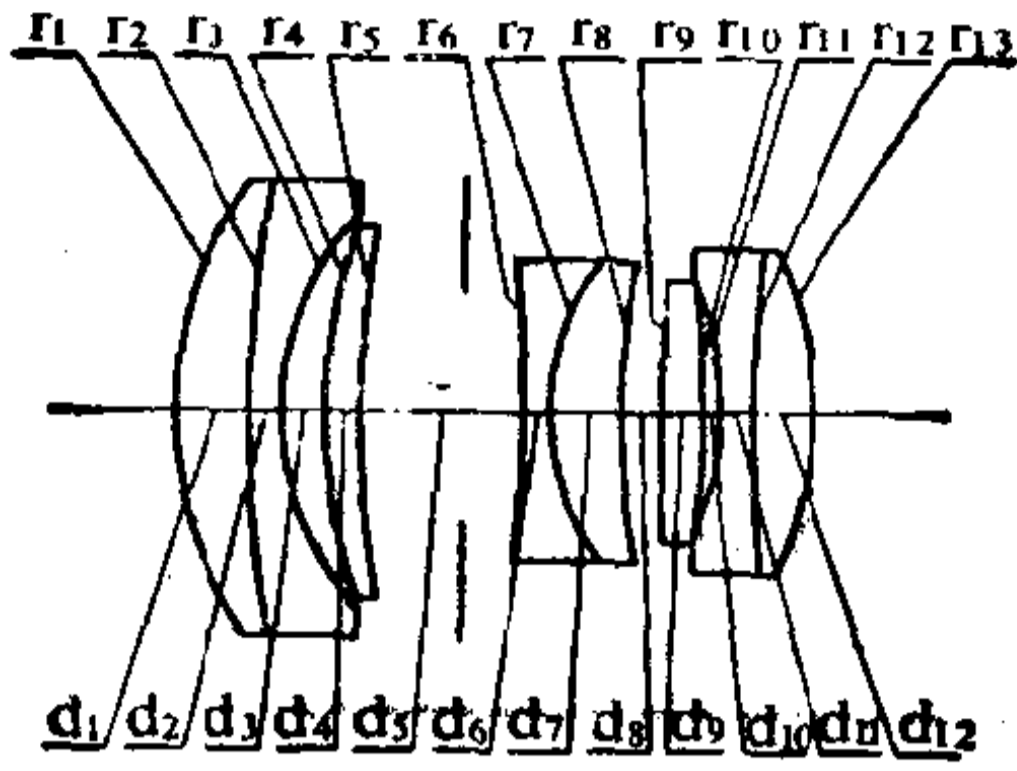

序号	r	d	n _d	v _d	序号	r	d	n _d	v _d
1	0.2534	0.0500	1.6968	55.6	8	0.6164	0.0224		
2	1.1473	0.0200	1.5814	40.8	9	5.7274	0.0250	1.6968	55.6
3	0.1904	0.0250			10	-0.4841	0.0120		
4	0.3650	0.0250	1.6968	55.6	11	-0.2043	0.0200	1.5814	40.8
5	0.7042	0.1039*			12	0.6874	0.0400	1.6968	55.6
6	-1.1127	0.0150	1.6228	56.9	13	-0.2432			
7	-0.1656	0.0500	1.5920	48.5					

0.1039* = 0.0639 + 0.0400

	ΣS ₁	ΣS ₂	ΣS ₃	ΣS ₄	ΣS ₅	HI	QP(1ω)
	-0.0000105	-0.0000078	-0.0000133	-0.0000242	-0.0000569	0.268	-0.12%
h 或 ω %	LA'	ΔH'	x _t '	x _s '	x _t - x _s	K _{T1} '	K _{T0.7} '
100	0.000272	-0.000325	0.001755	-0.000077	0.001833	0.000659	0.000156
70	-0.000084	-0.000116	-0.000695	-0.000656	-0.000039	0.000234	0.000039

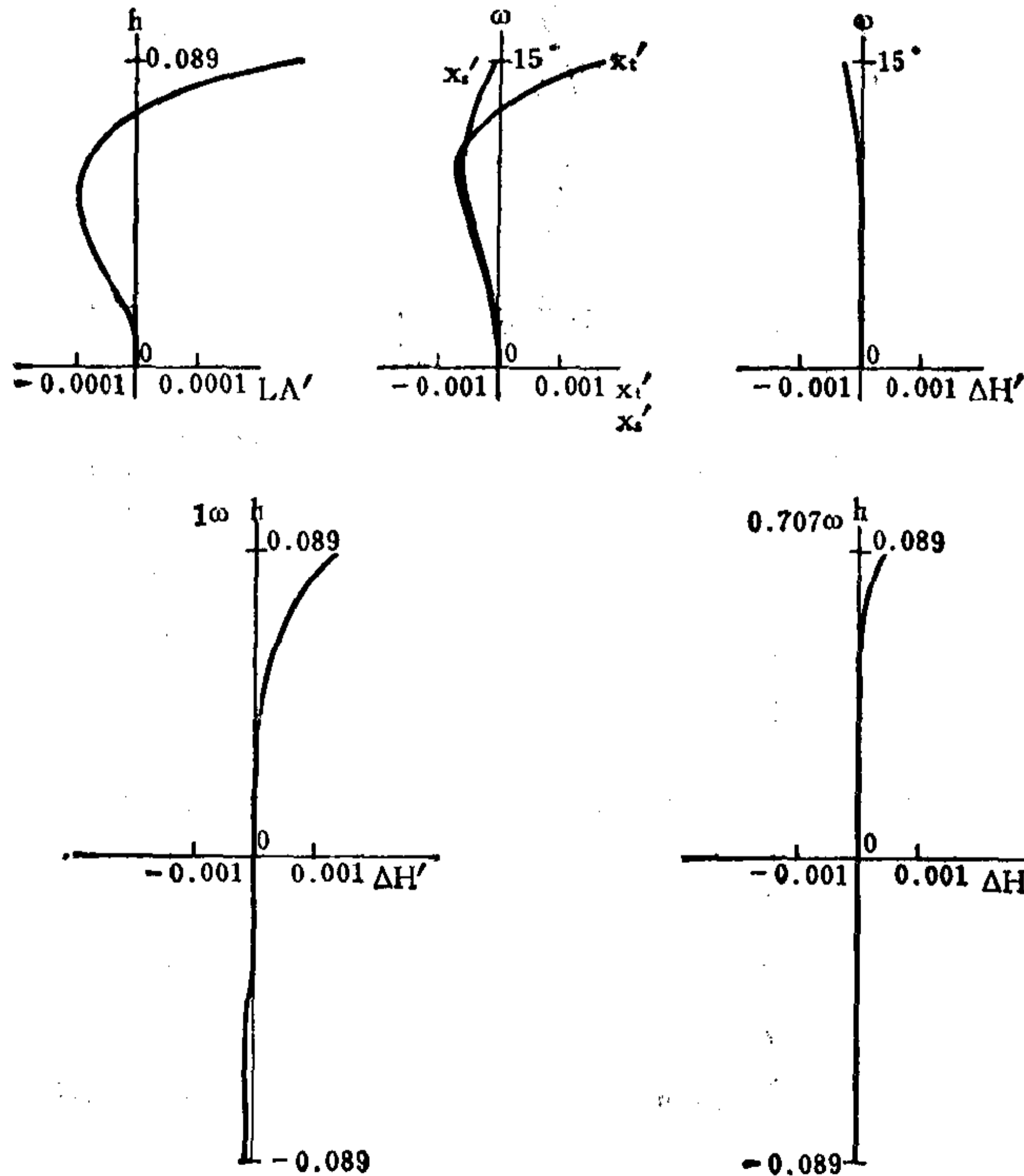

编号: 05-04-073

五组元摄影物镜

E.F.L=1.035

B.F.L=0.8946

FNo.=5.8

F.A.=±15°

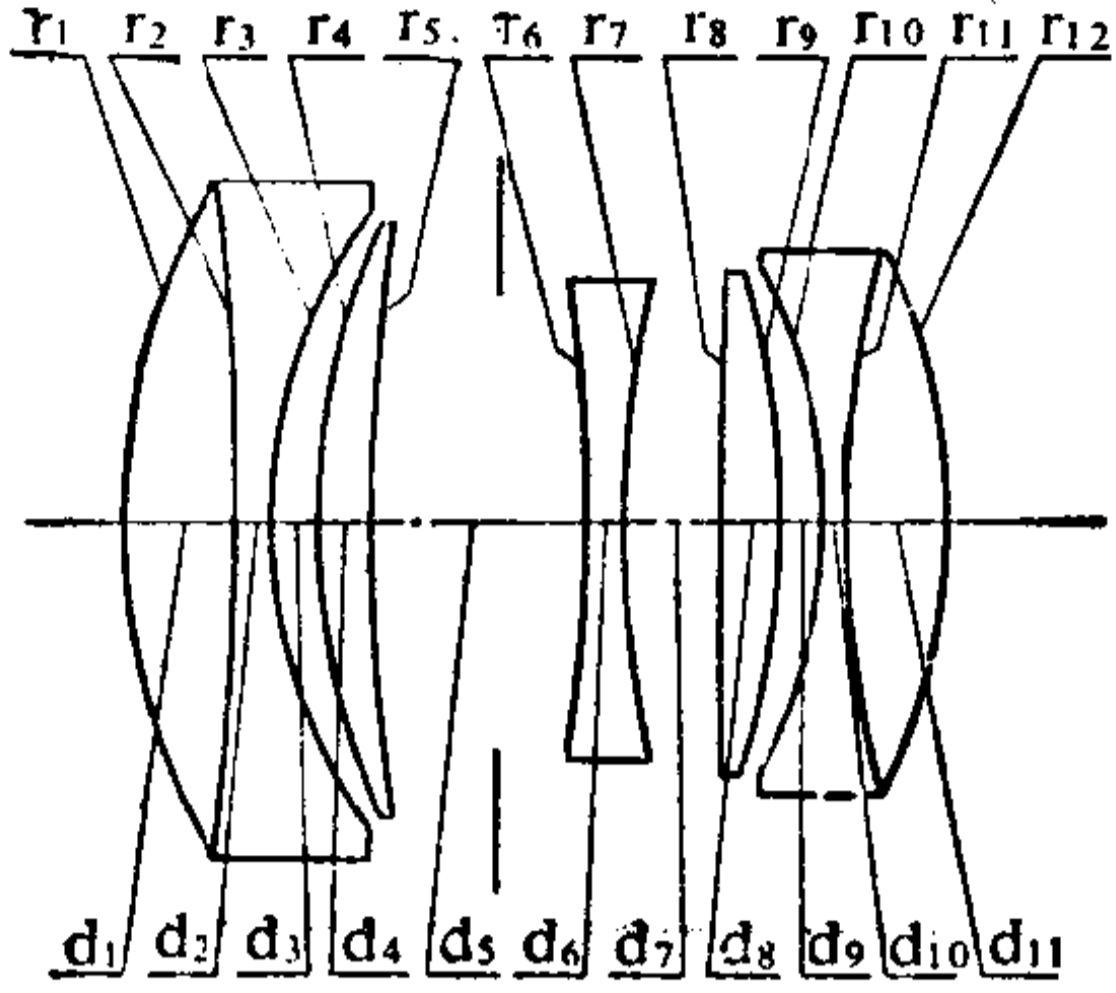

序号	r	d	n _d	v _d	序号	r	d	n _d	v _d
1	0.2583	0.0400	1.6204	60.3	7	0.3960	0.0335		
2	-0.9211	0.0120	1.5294	51.8	8	4.8054	0.0200	1.6204	60.3
3	0.1953	0.0180			9	-0.3152	0.0160		
4	0.2743	0.0200	1.6204	60.3	10	-0.1915	0.0100	1.5294	51.8
5	0.7614	0.0745*			11	0.4248	0.0350	1.6204	60.3
6	-0.5011	0.0150	1.6584	50.9	12	-0.2308			

*0.0745 = 0.0445 + 0.0300

	ΣS ₁	ΣS ₂	ΣS ₃	ΣS ₄	ΣS ₅	HI	QP (1ω)
	0.0000925	0.0000175	0.0000012	-0.0000425	0.0000542	0.277	0.12%
h 或 ω %	LA'	ΔH'	x _t	x _s	x _t - x _s	K _{T1}	K _{T0.7}
100	0.00826	0.00034	0.00014	-0.00016	0.00030	0.000462	0.000200
70	0.00370	0.00012	-0.00059	-0.00078	0.00019	0.000325	0.000142

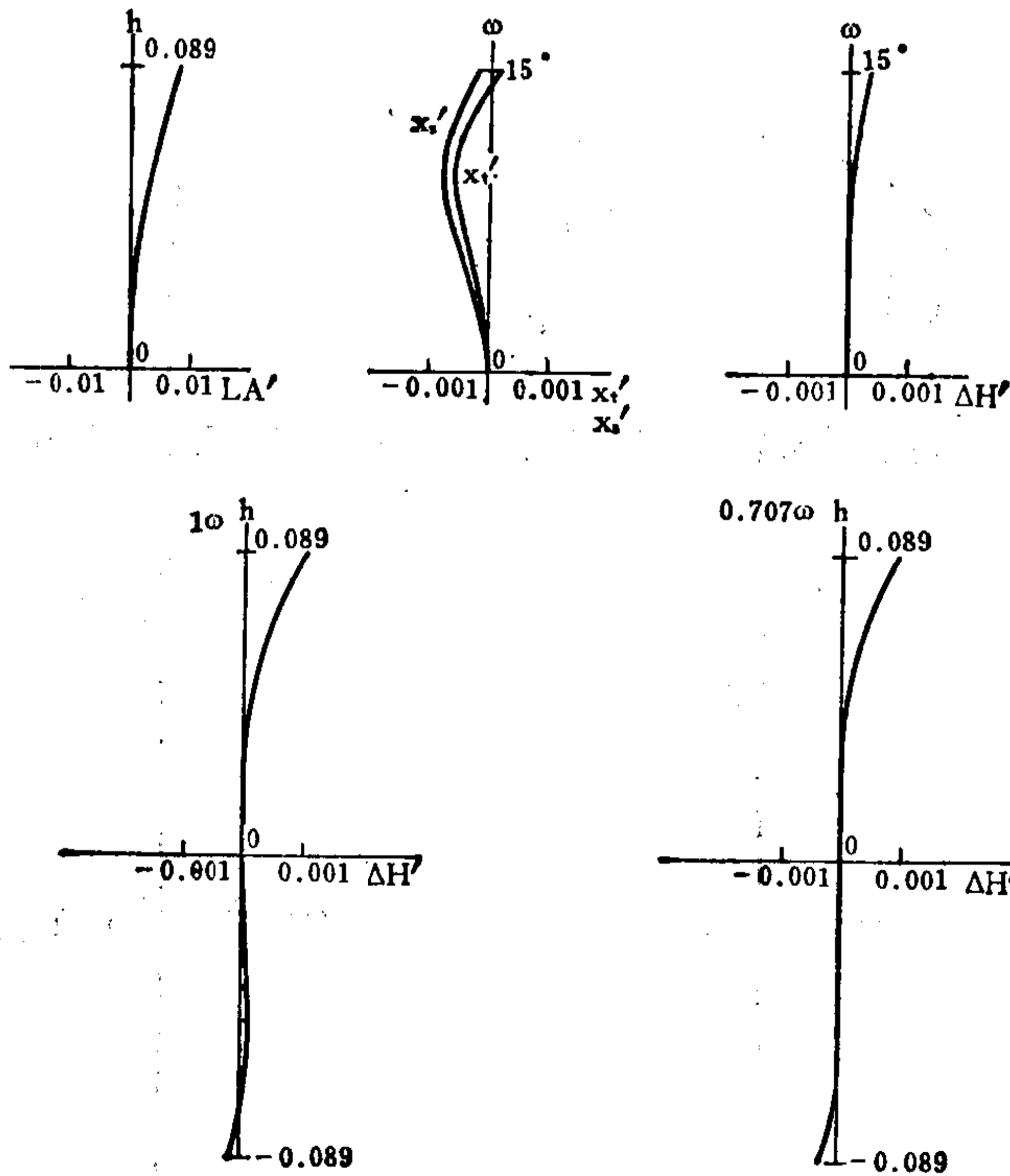

编号: 05-04-074

四组元照相物镜

E.F.L.=1.0

B.F.L.=1.017

FNo.=3.5

F.A.=±30°

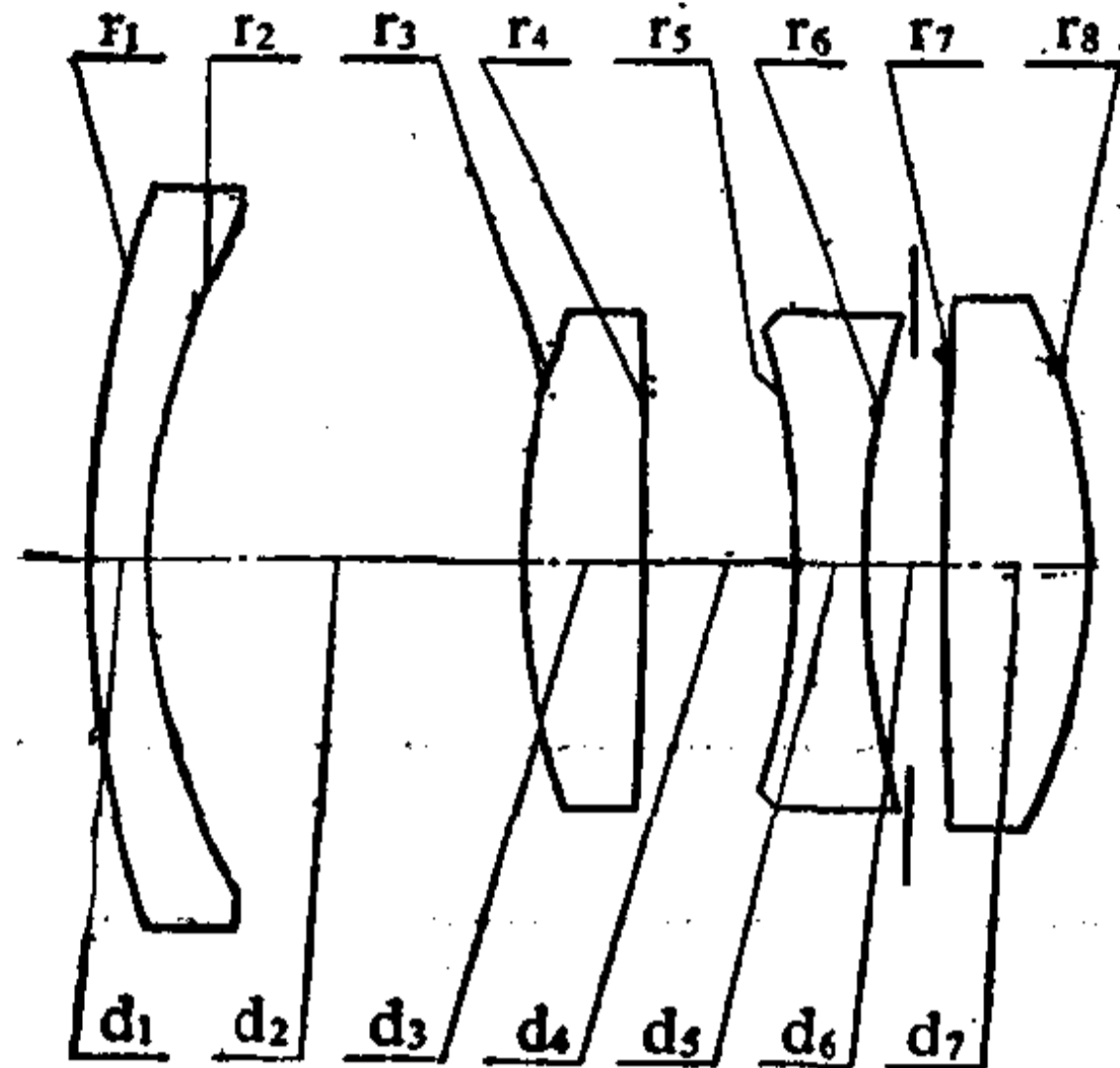

序号	r	d	n _D	v _D	序号	r	d	n _D	v _D
1	0.6845	0.0295	1.52011	64.9	5	-0.4438	0.0398	1.66886	35.2
2	0.3700	0.2051			6	0.4567	0.0427*		
3	0.3939	0.0671	1.72340	50.2	7	2.0819	0.0795	1.62286	60.0
4	-4.8516	0.0828			8	-0.3366			

0.0427* = 0.0227 + 0.0200

注: 前部两个透镜可移动聚焦。

	ΣS ₁	ΣS ₂	ΣS ₃	ΣS ₄	ΣS ₅	HI	QP (1ω)
	-0.001048	-0.000008	0.000162	-0.001388	-0.000766	0.578	-0.18%
h 或 ω %	LA'	ΔH'	x _t '	x _s '	x _t ' - x _s '	K _{T1}	K _{T0.7}
100	0.02045	-0.00105	0.01196	0.01205	-0.00009	-0.01161	-0.00532
70	-0.00631	-0.00101	0.00045	-0.00785	0.00830	-0.00127	-0.00105

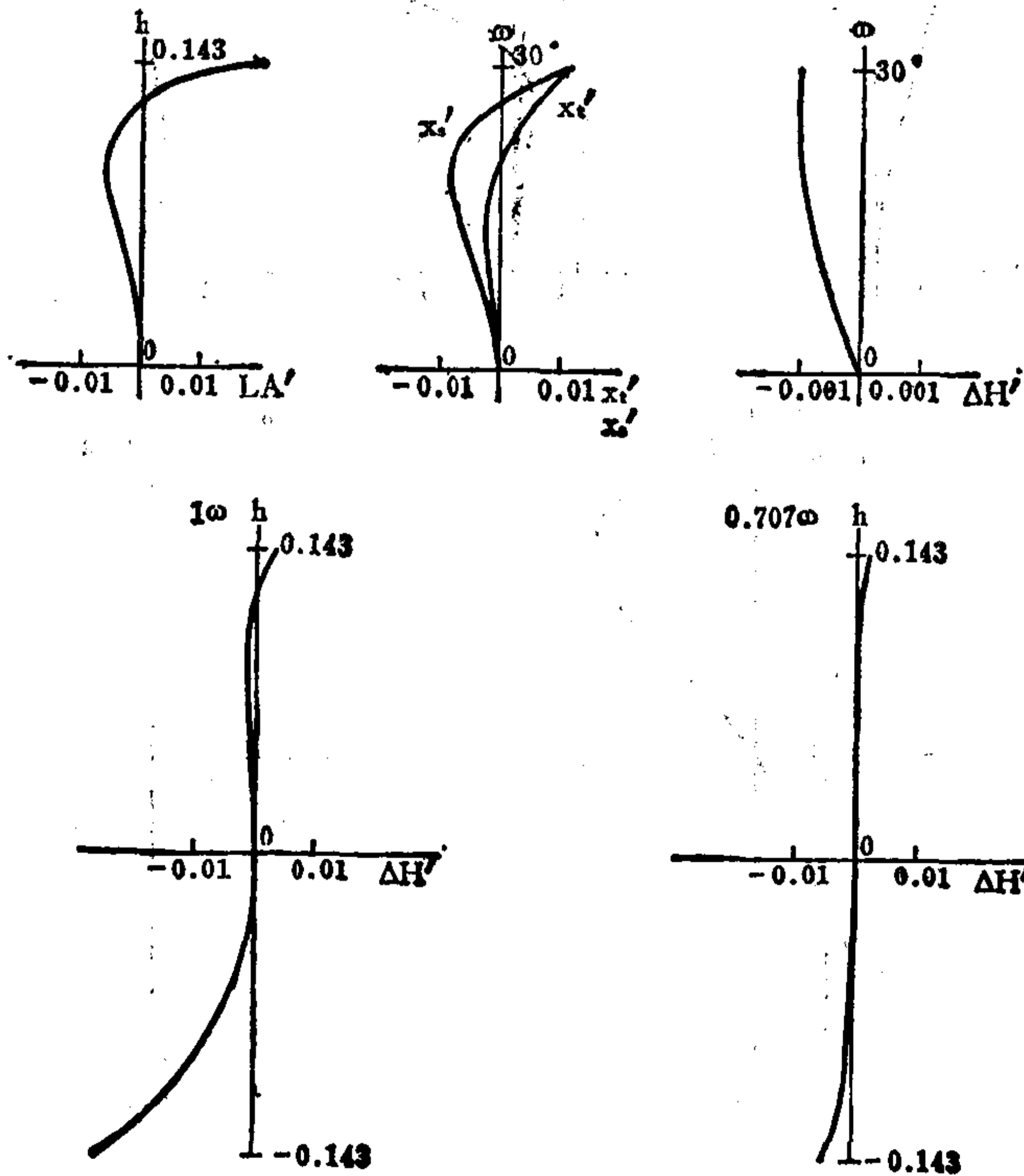

编号: 05-04-075

四组元物镜

E.F.L=99.91

B.F.L=18.04

FNo.=6.5

F.A.=±40.1' **

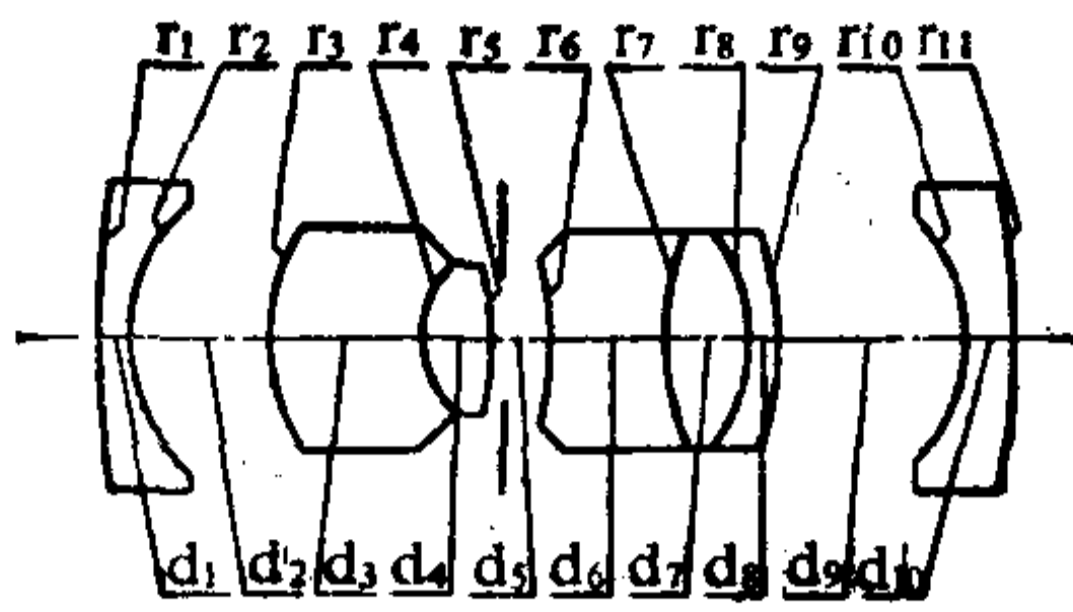

序号	r	d	n _D	v _D	序号	r	d	n _D	v _D
1	232.61	7.89	1.498	67.0	7	71.16	21.16	1.753	50.6
2	47.19	36.40			8	-45.53	6.70	1.720	29.3
3	52.37	39.23	1.784	26.1	9	-86.18	49.39		
4	26.32	17.35	1.498	67.0	10	-44.90	12.07	1.498	67.0
5	-84.80	14.31*			11	-205.38			
6	-102.53	31.07	1.498	67.0					

14.31* = 2.00 + 12.31

	ΣS ₁	ΣS ₂	ΣS ₃	ΣS ₄	ΣS ₅	HI	QP (1ω)
	-0.00251	-0.00191	-0.00107	-0.00158	-0.05456	84.1	1.2%
h 或 ω %	LA'	ΔH'	x _i '	x _s '	x _i ' - x _s '	K _{i1}	K _{T0.7}
100	-0.123	1.008	5.224	-0.223	5.447	-0.0276	0.0696
70	-0.085	-0.034	0.042	-0.172	0.214	-0.0206	-0.0047

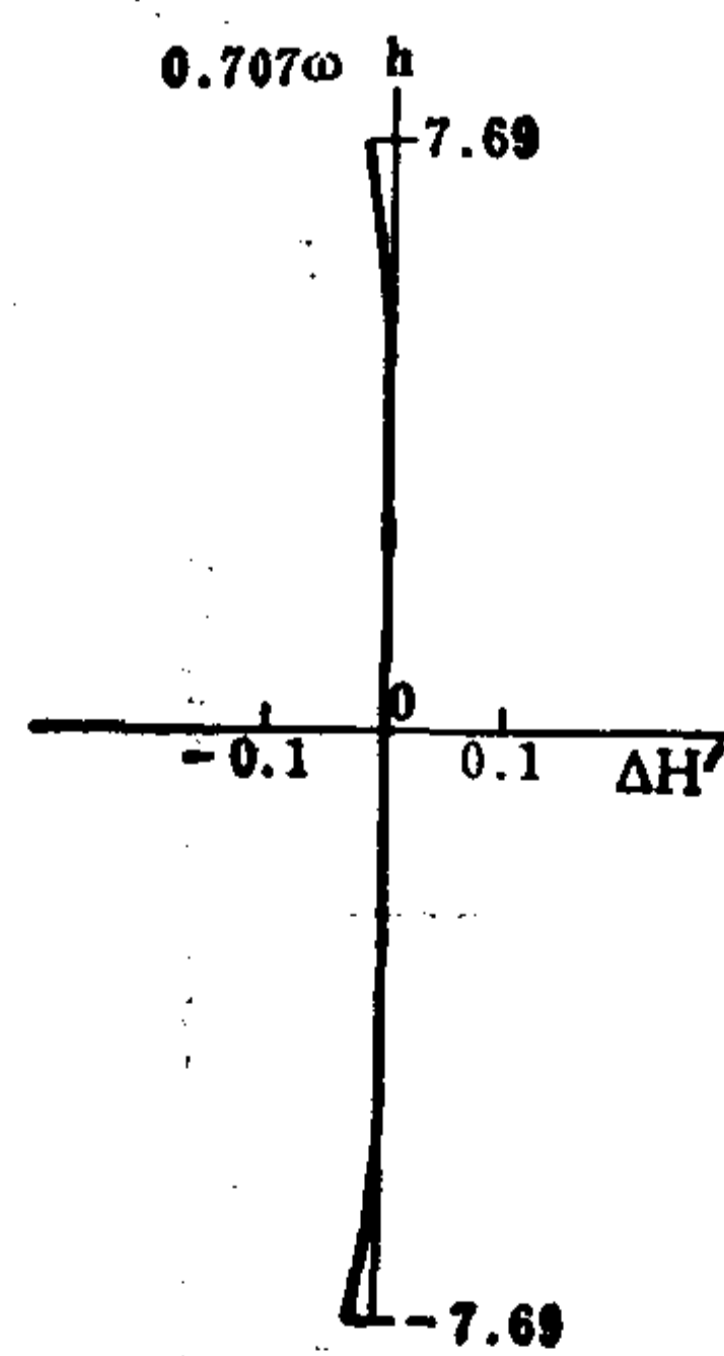
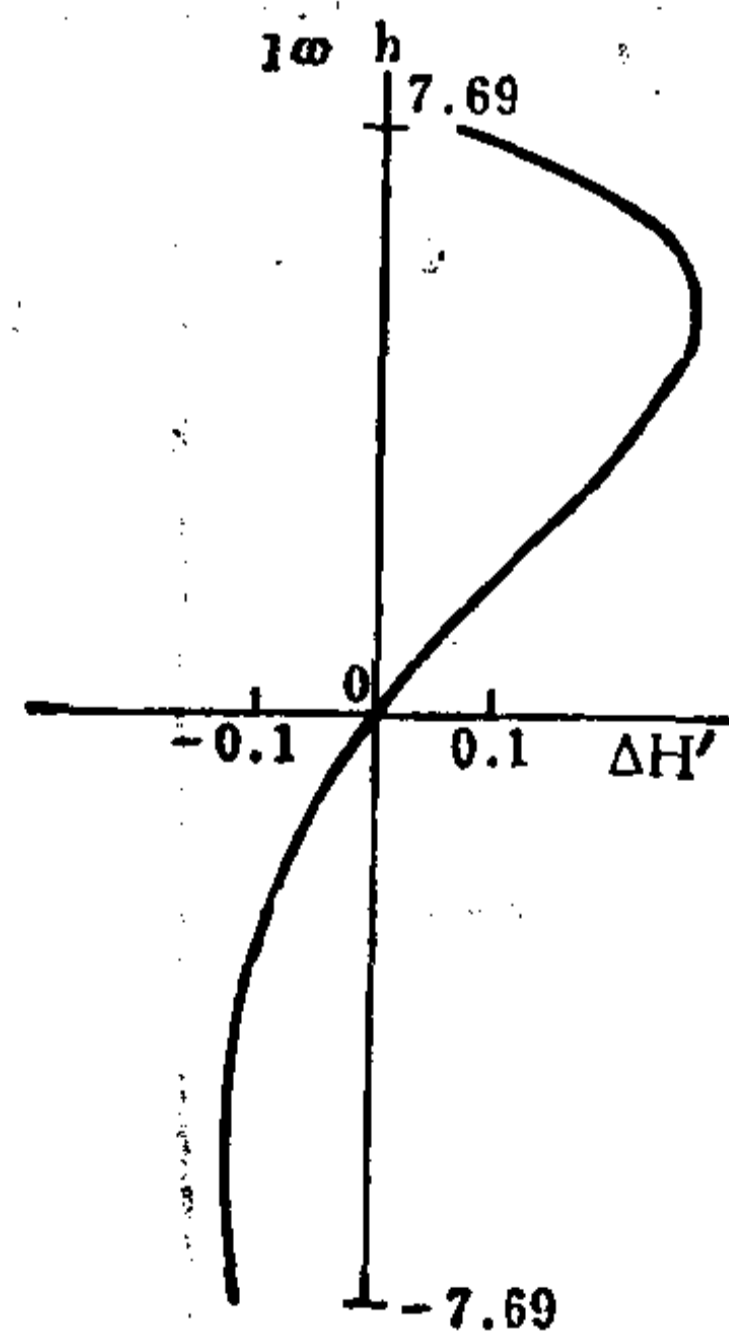
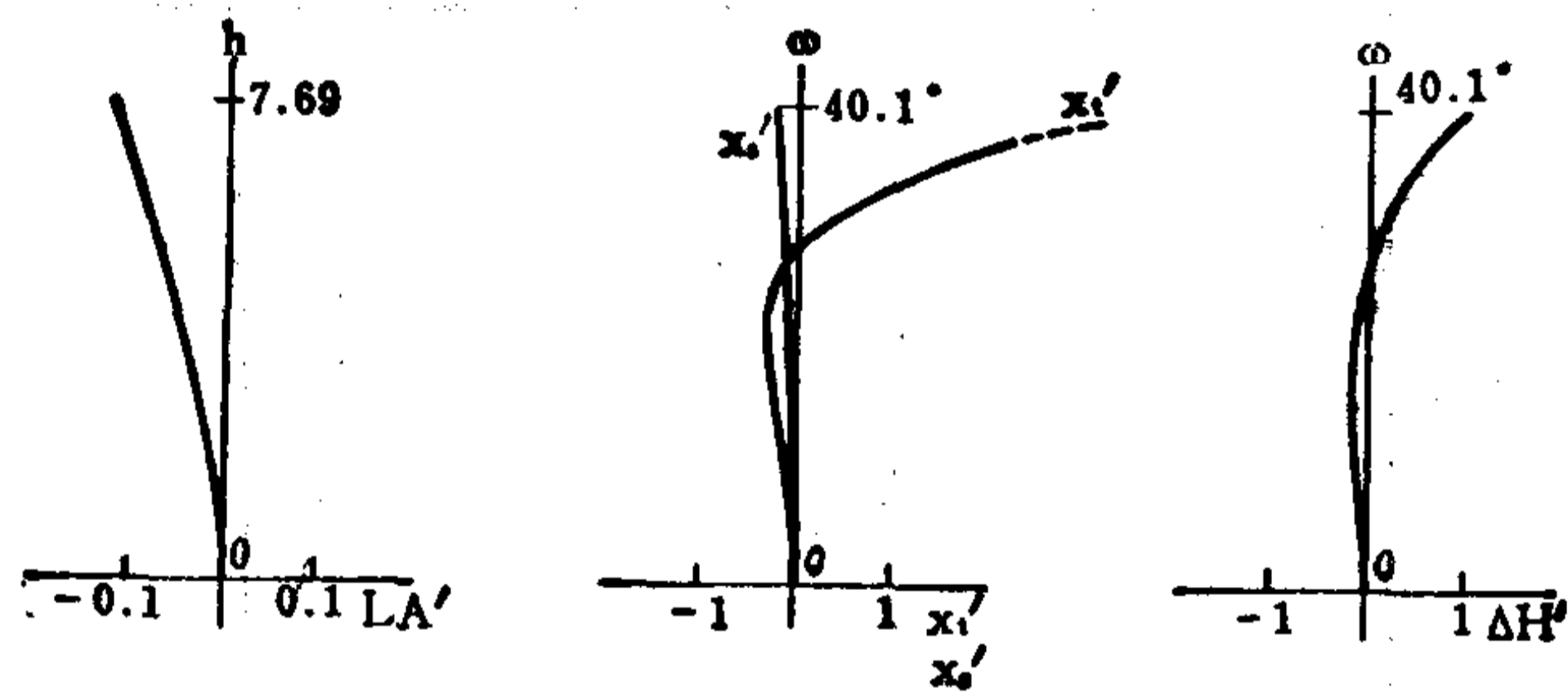

编号: 05-04-076

三组四片投影透镜系统

E.F.L=101.9

B.F.L=85.13

FN₀ = 3.57

F.A. = ± 17.7°

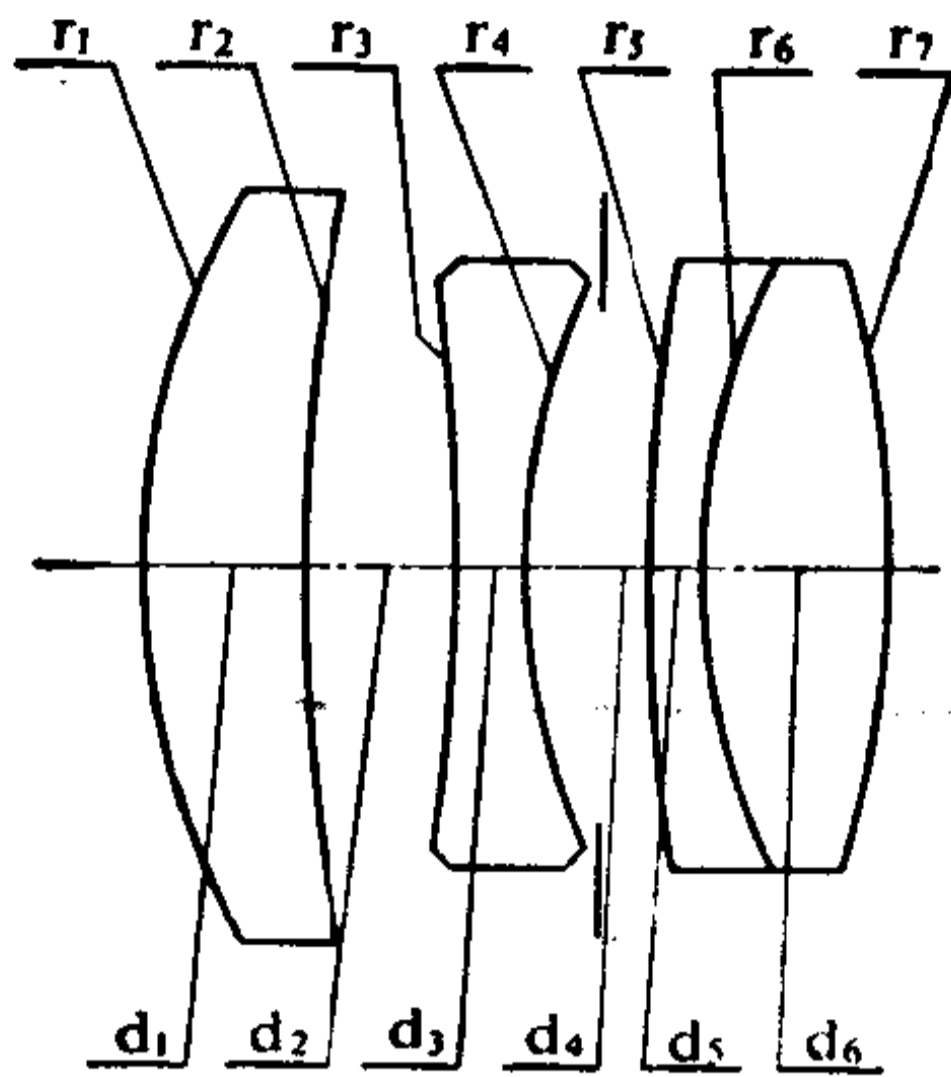

序号	r	d	n _D	v _D	序号	r	d	n _D	v _D
1	41.6	8.73	1.73	51.3	5	192.8	2.96	1.62	36.6
2	190.0	7.99			6	37.3	9.74	1.74	44.9
3	-86.7	3.55	1.67	32.2	7	-57.9			
4	37.3	6.72*							

6.72* = 3.76 + 2.96

	ΣS ₁	ΣS ₂	ΣS ₃	ΣS ₄	ΣS ₅	HI	QP(1 ω)
	- 0.03103	0.00712	0.01684	- 0.05677	- 0.06028	32.5	- 0.9%
h 或 ω %	LA'	ΔH'	x _t	x _s	x _t - x _s	K' _{T1}	K' _{T0.7}
100	- 0.032	- 0.300	0.274	- 0.562	0.836	- 0.1133	- 0.0290
70	- 0.234	- 0.092	0.045	- 0.408	0.453	- 0.0192	0.0055

注: 1. M = 21.5*;

2. 以上象差值是按 l = -∞ 计算的。

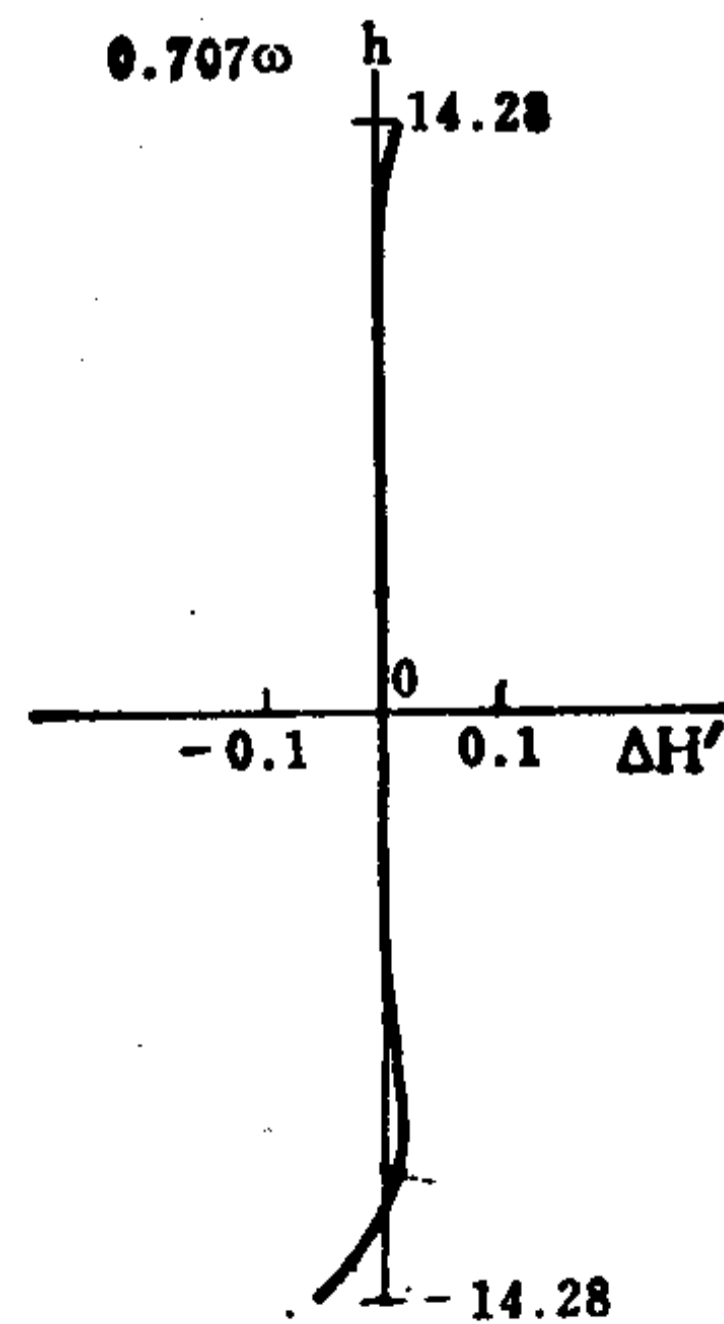
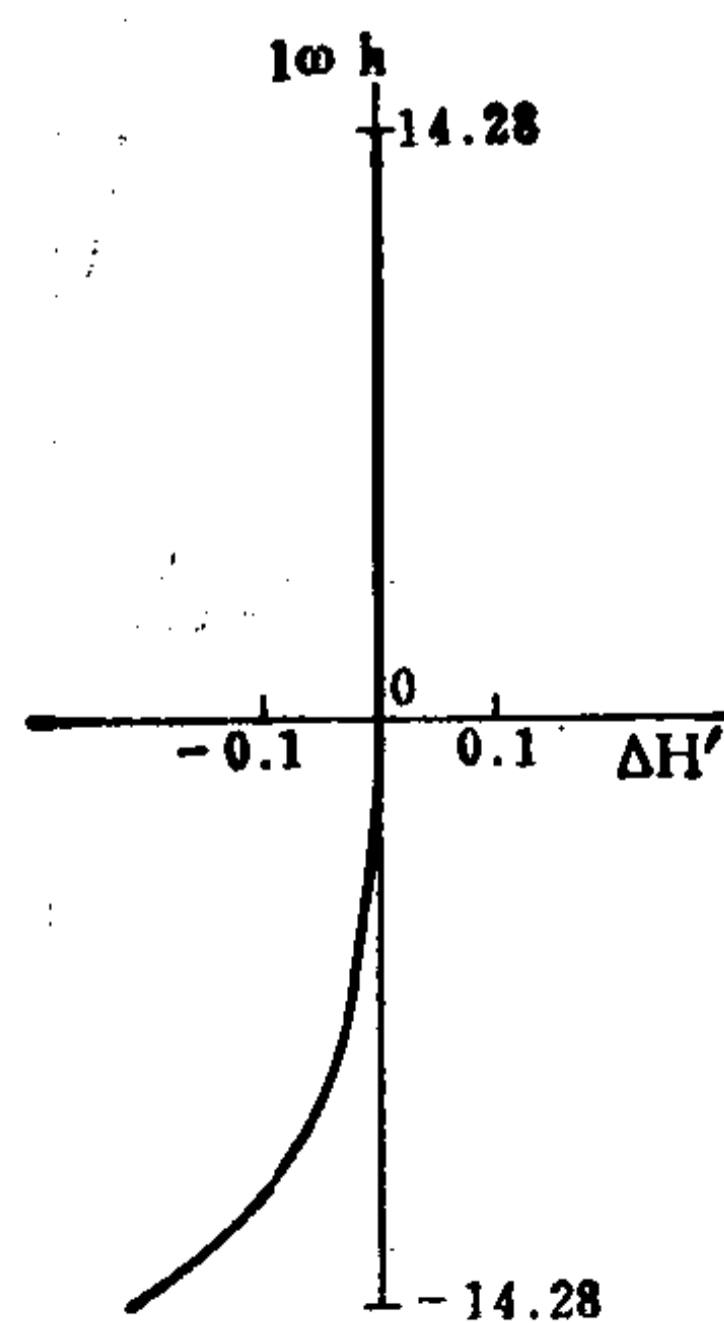
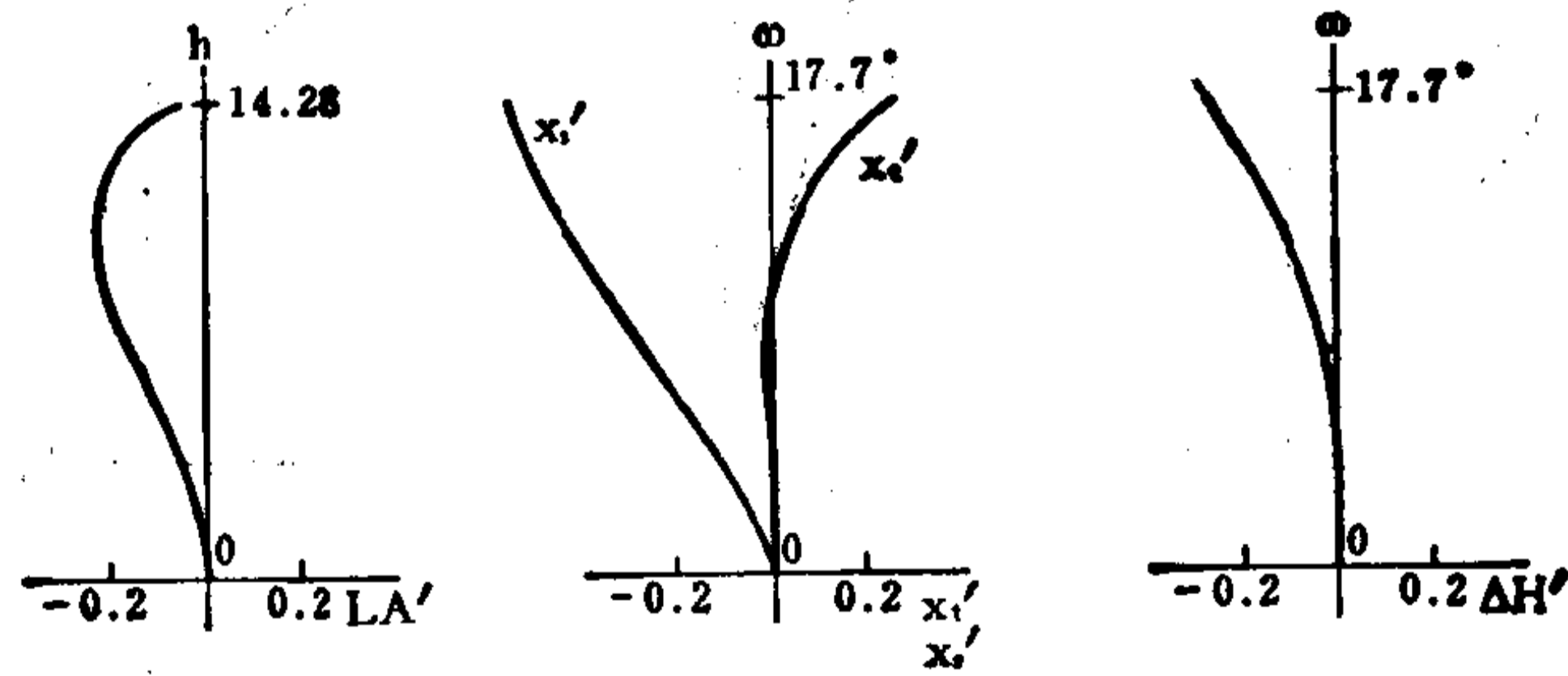

编号: 05-04-077

三组四片投影透镜系统

E. F. L = 101.77

B. F. L = 84.52

FNo. = 3.05

F. A. = ± 17.7°

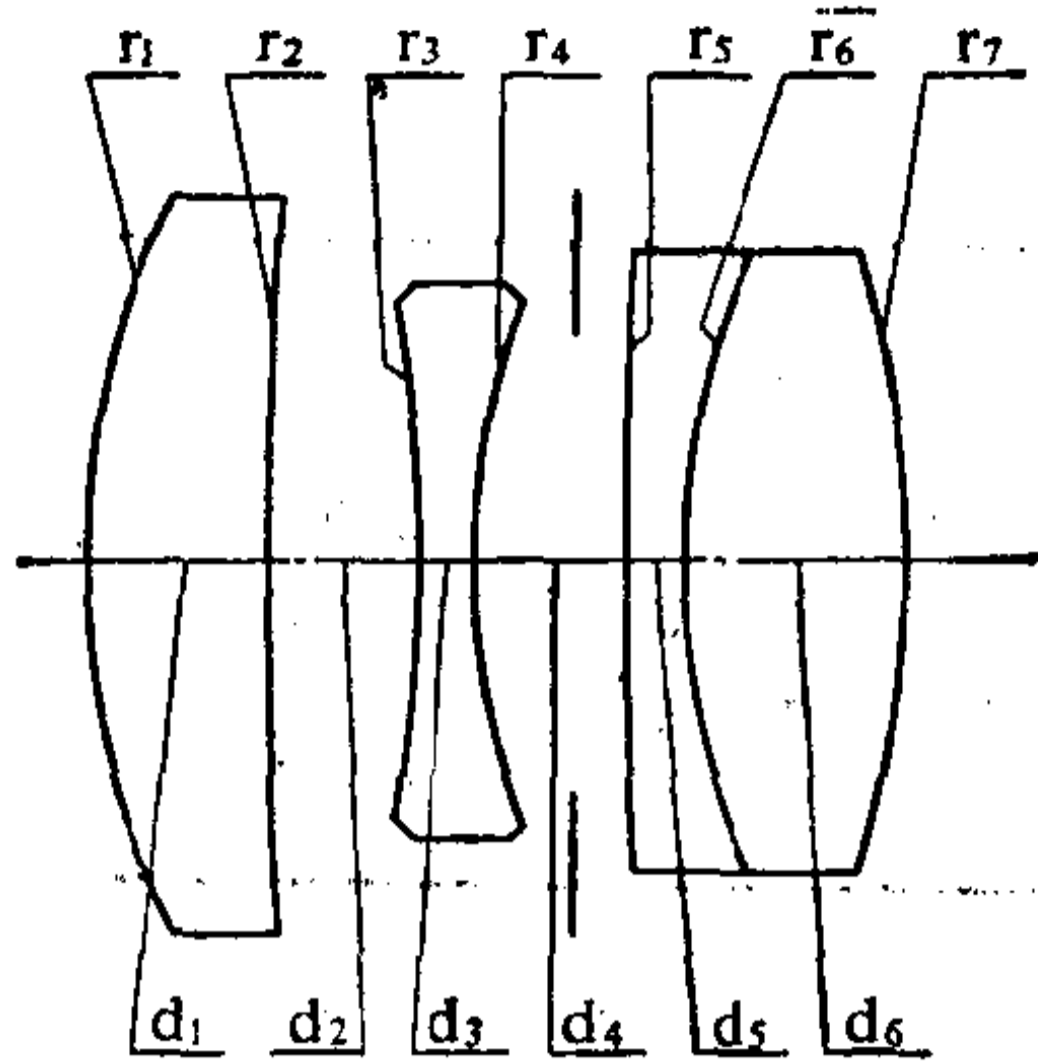

序号	r	d	n _D	v _D	序号	r	d	n _D	v _D
1	44.2	9.80	1.73	51.3	5	229.2	3.29	1.62	36.6
2	280.1	7.79			6	40.4	11.77	1.74	44.9
3	-89.9	3.29	1.67	32.2	7	-59.5			
4	39.0	7.93*							

$7.93^* = 5.16 + 2.77$

	ΣS_1	ΣS_2	ΣS_3	ΣS_4	ΣS_5	HI	QP(1ω)
	- 0.07736	0.01476	0.01910	- 0.08125	- 0.08504	32.5	- 1.1%
h 或 ω %	LA'	ΔH'	x _t	x _s	x _t - x _s	K' _{T1}	K' _{T0.7}
100	- 0.390	- 0.346	- 0.044	- 0.716	0.672	- 0.2193	- 0.0509
70	- 0.508	- 0.108	- 0.108	- 0.482	0.374	- 0.0448	0.0081

注: 1. M = 25.5*

2. 以上象差值是按 l = -∞ 计算的。

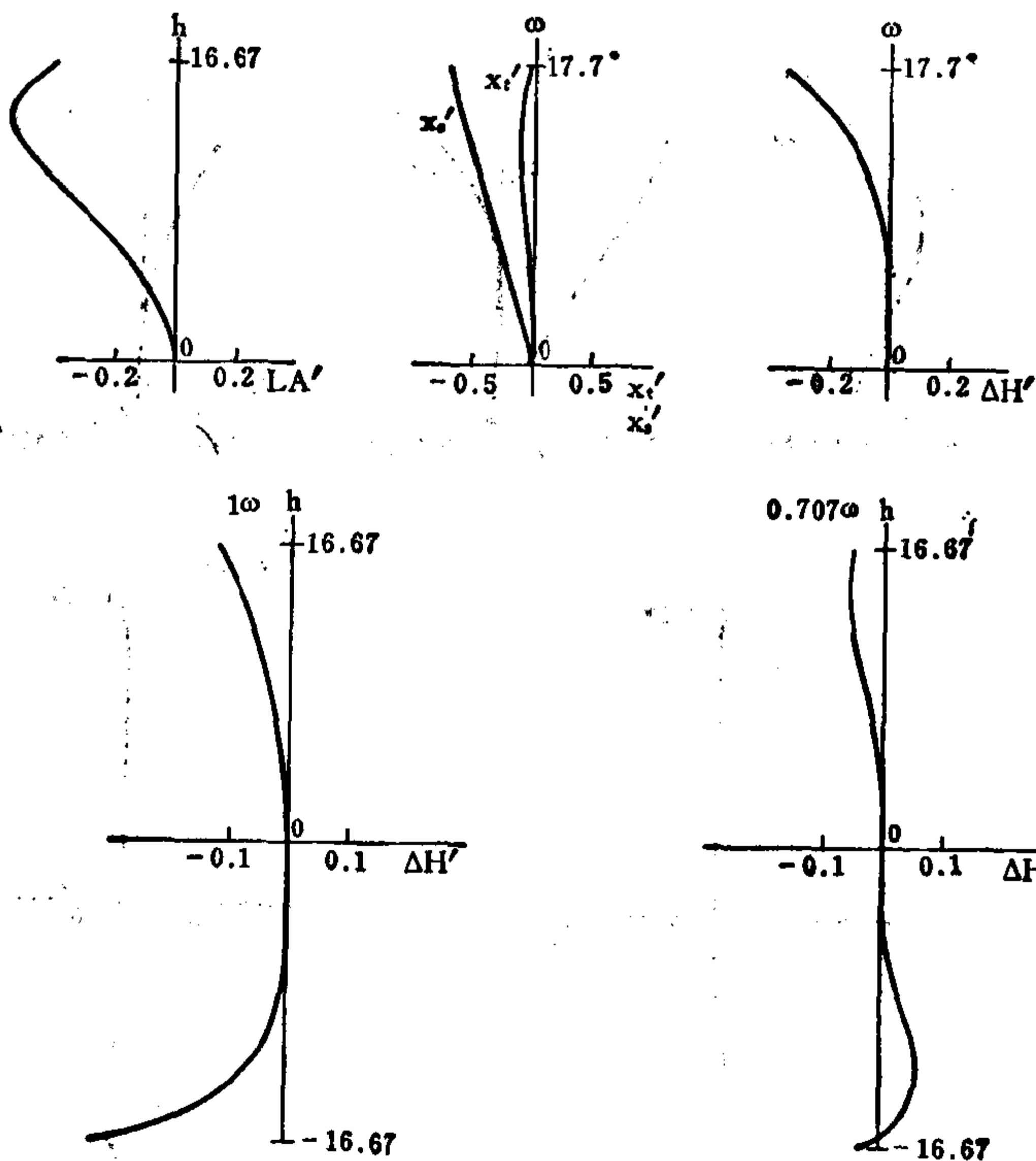

编号: 05-04-078

低色差透镜系统

E. F. L = 100°

B. F. L = 40.17

FN₀ = 4

F. A. = ± 8°

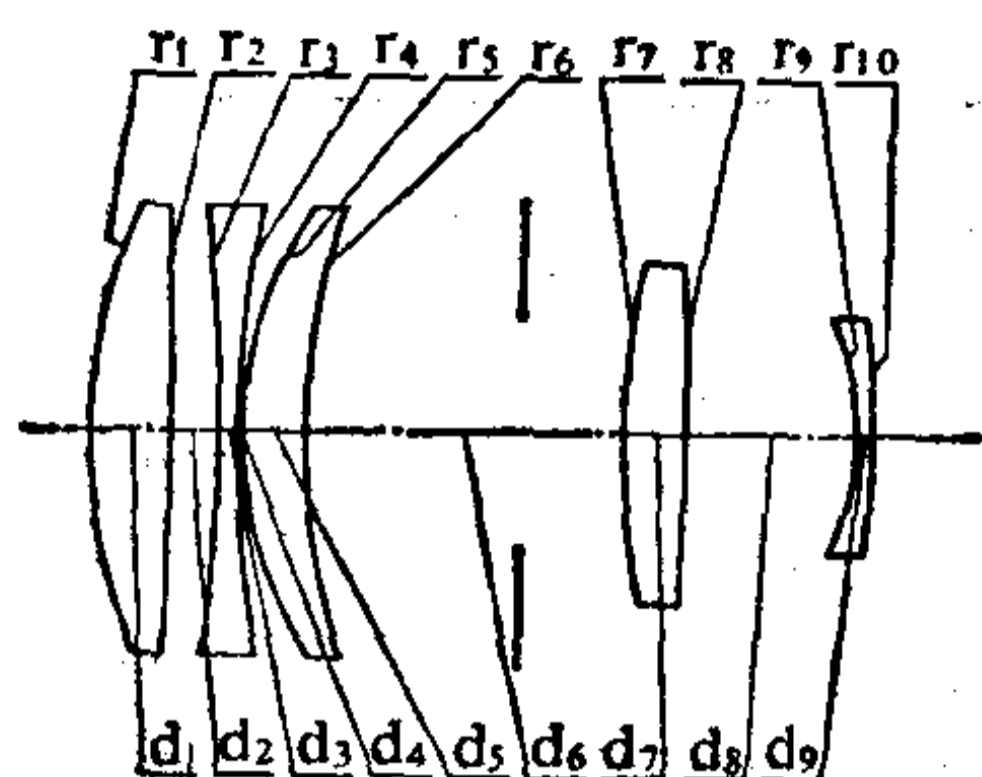

序号	r	d	n	v	序号	r	d	n	v
1	35.90	5.0	1.5163	64.0	6	46.32	20.0*		
2	-796.43	3.0			7	52.00	4.0	1.6034	38.0
3	-117.00	1.5	1.7174	29.5	8	-751.74	11.0		
4	86.77	0.2			9	-18.00	1.0	1.5111	60.5
5	26.60	4.0	1.5163	64.0	10	-58.21			

20.0* = 14.0 + 6.0

	ΣS_1	ΣS_2	ΣS_3	ΣS_4	ΣS_5	HI	QP(1 ω)
	-0.01098	0.00118	0.00080	-0.00528	0.02806	14.1	0.79%
h 或 ω %	LA'	$\Delta H'$	x'_i	x'_s	$x'_i - x'_s$	K'_{T1}	$K'_{T0.7}$
100	0.0631	0.1121	-0.0185	-0.1266	0.1081	0.0194	0.0106
70	-0.0858	0.0398	-0.0275	-0.0678	0.0403	0.0111	0.0059

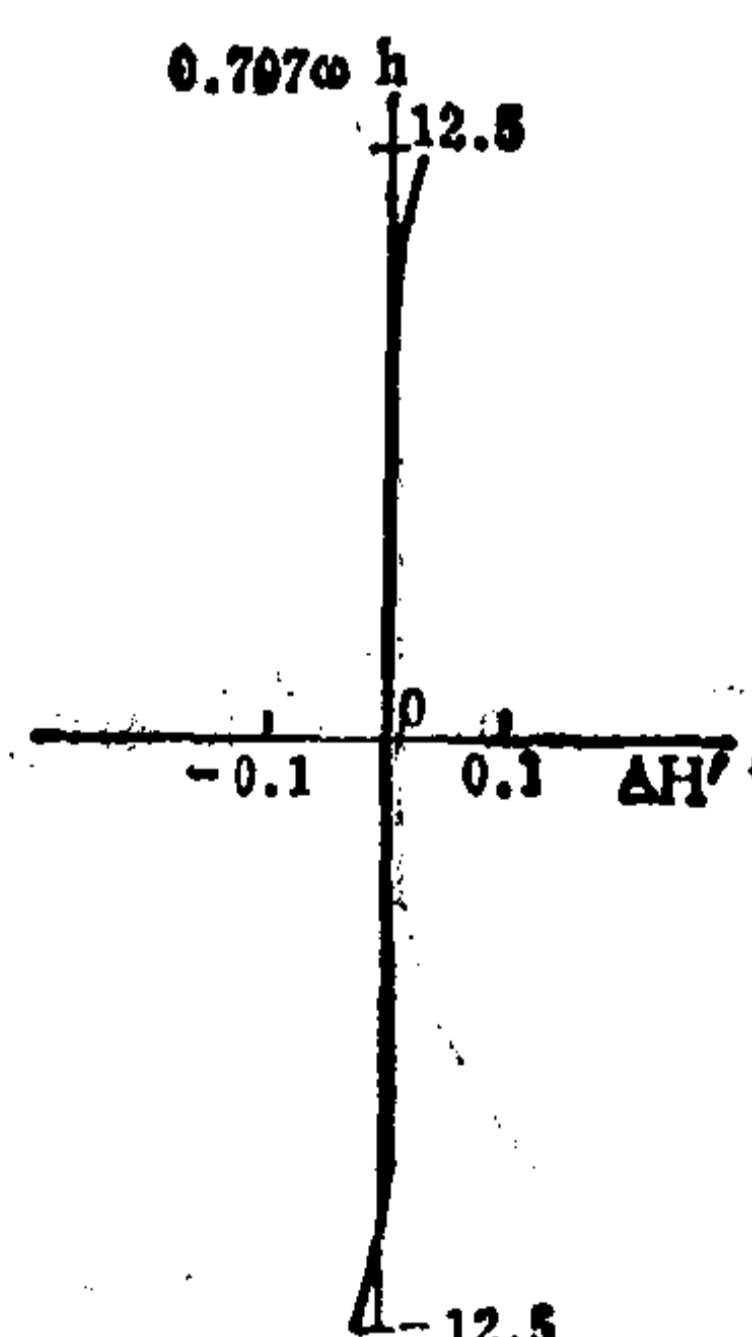
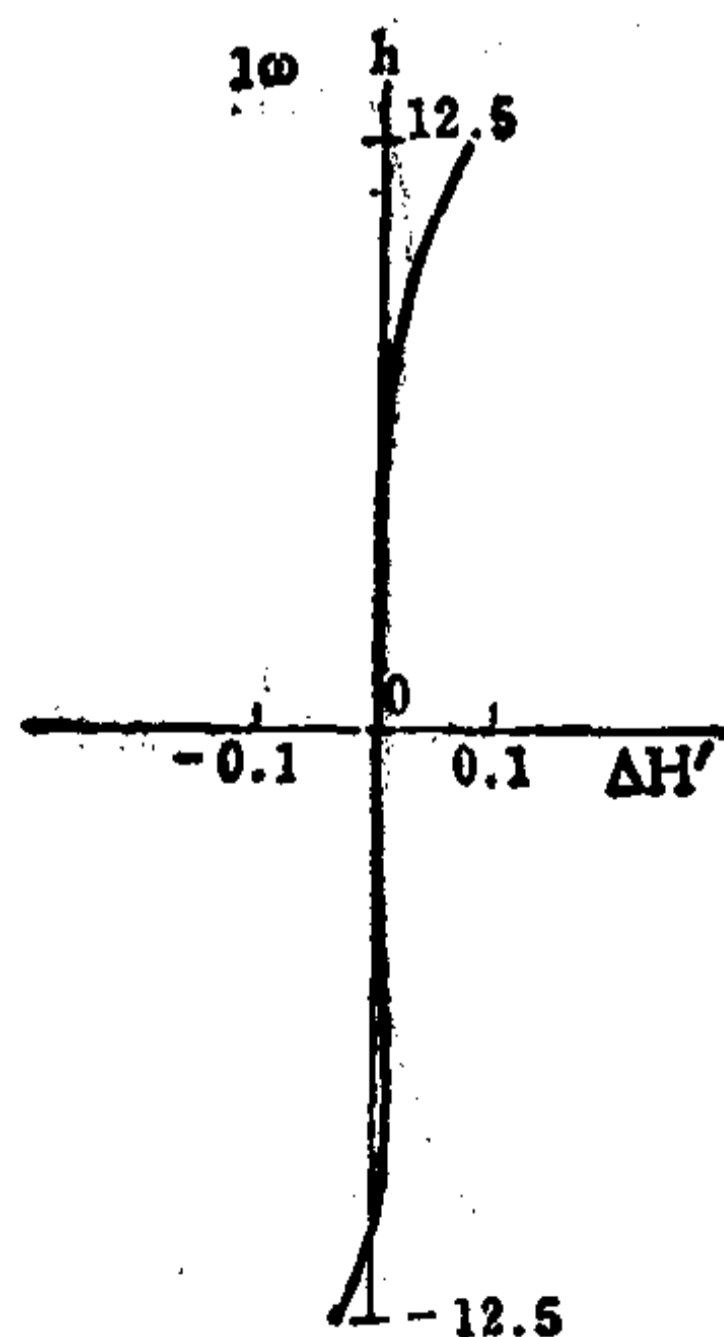
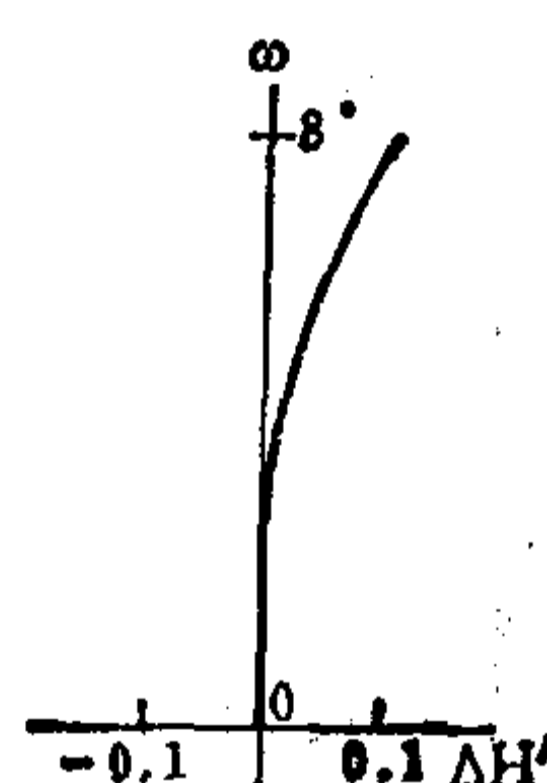
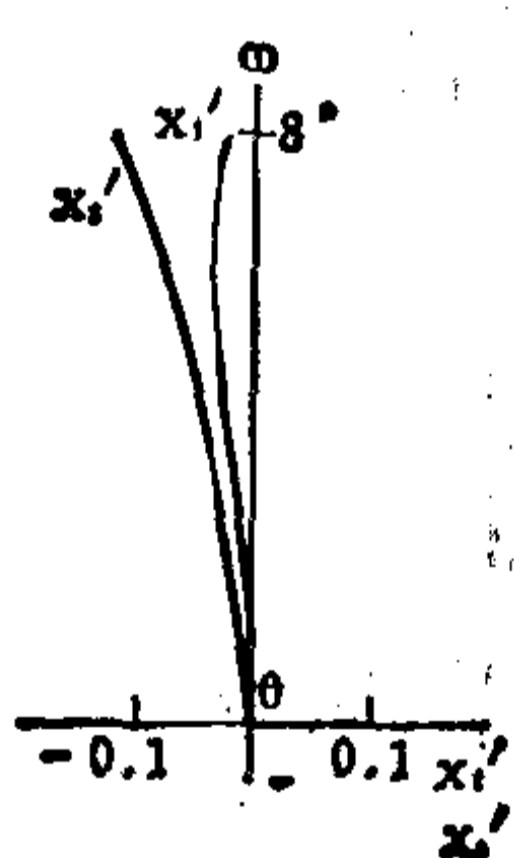
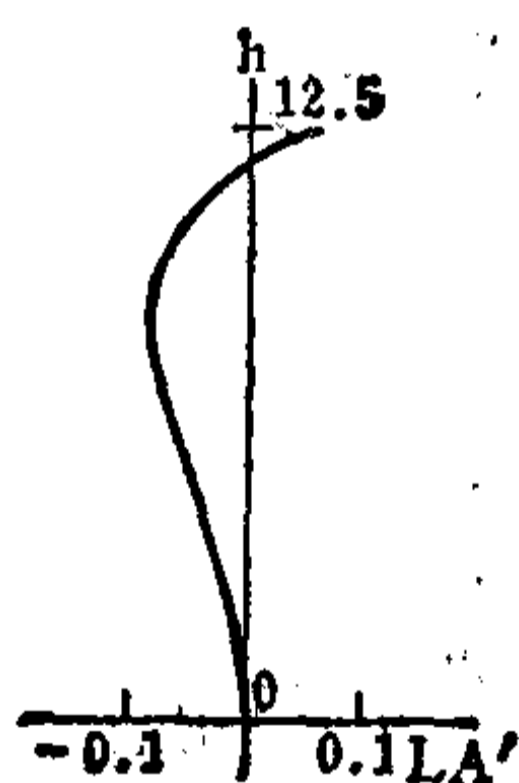

编号: 05-04-079

低色差透镜系统

E. F. L = 99.98

B. F. L = 33.51

FNo. = 4.5

F. A. = ± 4.1°

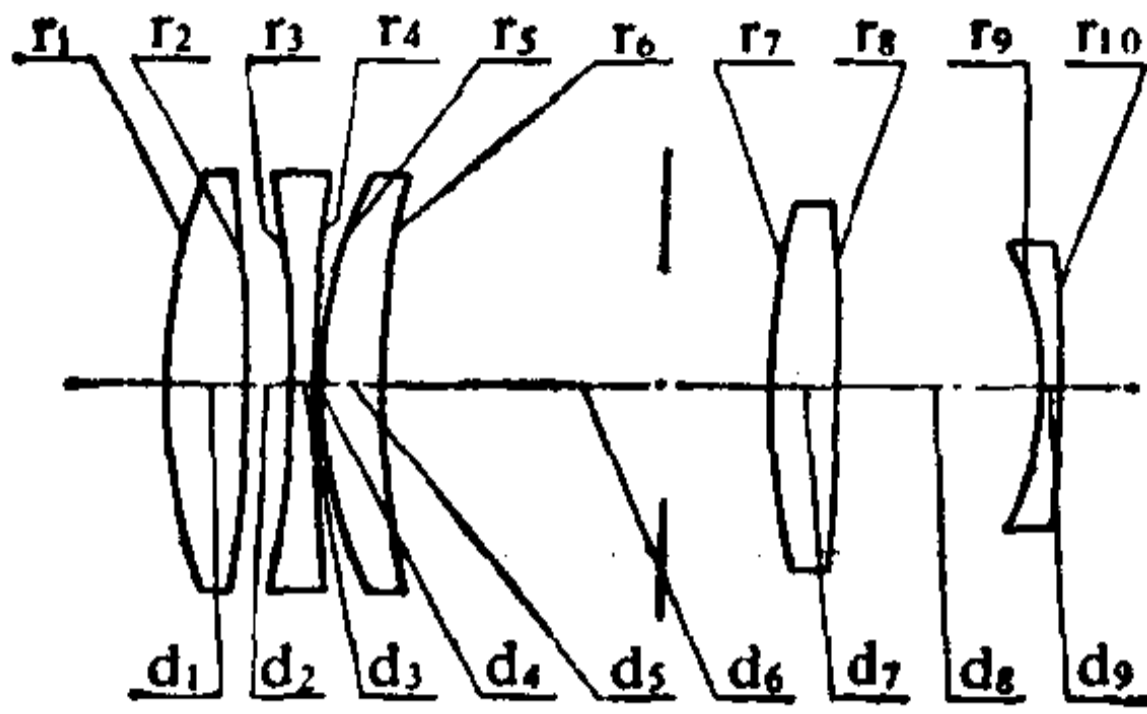

序号	r	d	n	v	序号	r	d	n	v
1	40.000	5.0	1.4339	94.7	6	60.389	25.0*		
2	-193.927	3.0			7	49.400	4.0	1.5601	47.0
3	-82.000	1.5	1.6200	36.3	8	-340.211	13.2		
4	188.429	0.2			9	-20.28	1.0	1.5891	61.2
5	30.000	4.0	1.4339	94.7	10	-104.691			

25.0* = 18.0 + 7.0

	ΣS_1	ΣS_2	ΣS_3	ΣS_4	ΣS_5	HI	QP(1 ω)
	-0.00154	-0.00014	0.00013	-0.00069	0.00482	7.2	0.3%
h 或 ω %	LA'	$\Delta H'$	x'_i	x'_s	$x'_i - x'_s$	K'_{T1}	$K'_{T0.7}$
100	-0.0020	0.0217	-0.0017	-0.0206	0.0189	-0.00999	-0.00347
70	-0.0165	0.0076	-0.0033	-0.0108	0.0075	-0.00597	-0.00201

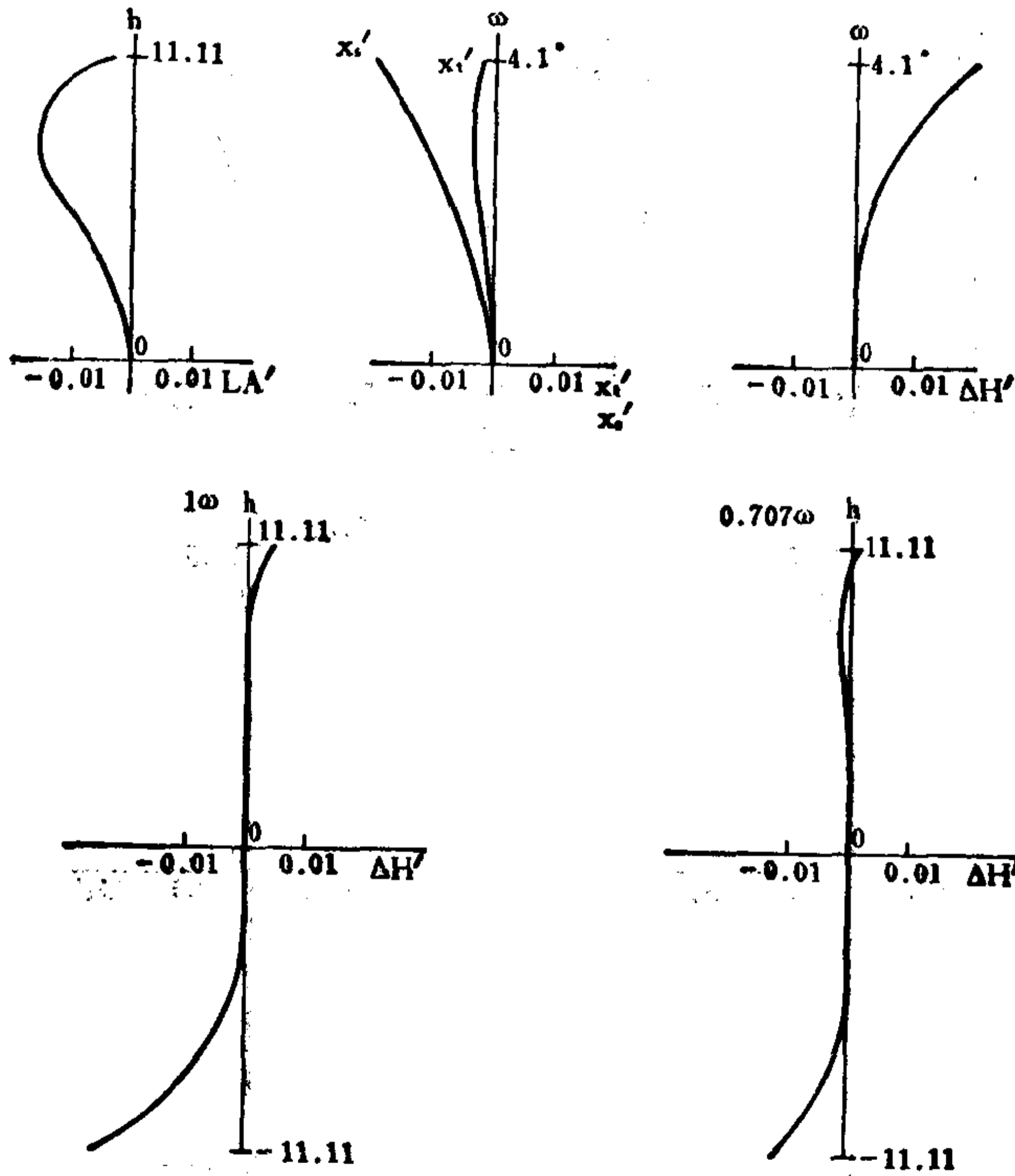

编号: 05-04-080

远距离照相镜头

E. F. L = 100.02

B. F. L = 31.99

FNo. = 4

F. A. = ± 6.01°

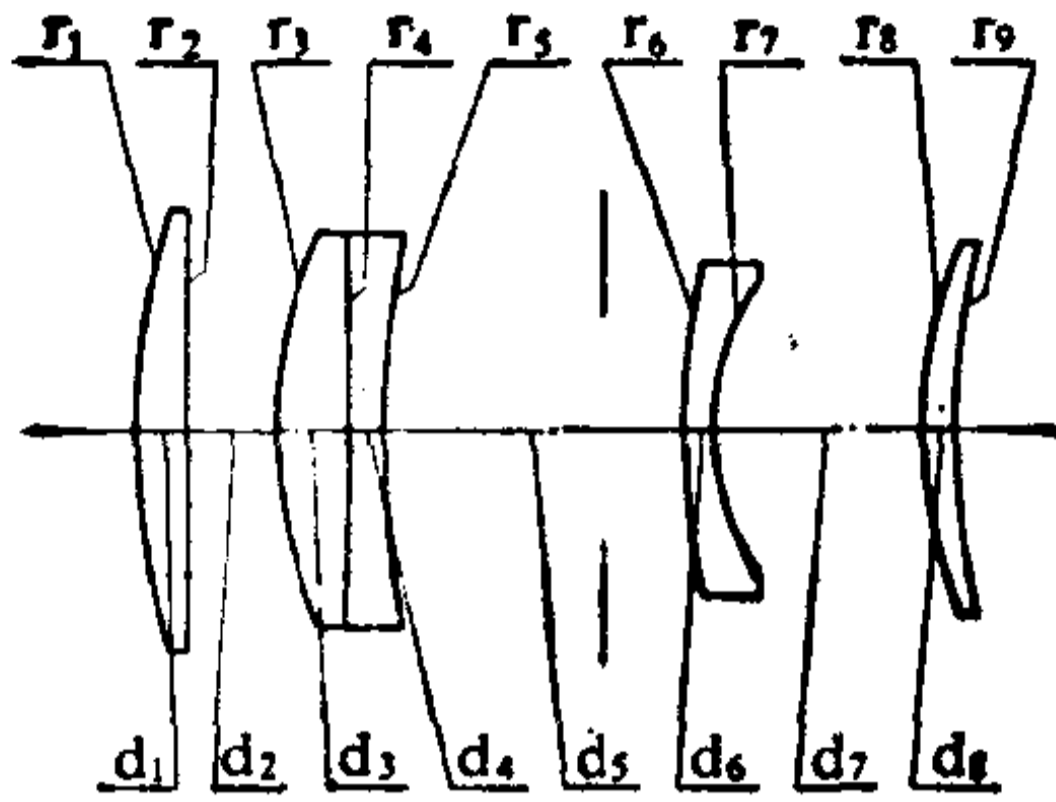

序号	r	d	n	v	序号	r	d	n	v
1	50.727	3.18	1.62041	60.2	6	51.530	1.84	1.67790	55.3
2	∞	5.81			7	17.371	13.42		
3	30.358	4.84	1.48749	69.8	8	32.302	2.12	1.78472	25.6
4	-551.360	2.26	1.76182	26.5	9	52.335			
5	65.822	19.25*							

19.25* = 14.00 + 5.25

	ΣS_1	ΣS_2	ΣS_3	ΣS_4	ΣS_5	HI	QP(1ω)
	-0.00236	-0.00136	0.00022	-0.00236	0.03687	10.54	1.37%
h 或 ω %	LA'	ΔH'	x _t '	x _s '	x _t ' - x _s '	K _{T1} '	K _{T0.7} '
100	-0.00335	0.1445	0.0263	-0.0319	0.0582	0.00281	0.00325
70	-0.02041	0.0519	-0.0070	-0.0257	0.0187	-0.00888	-0.00293

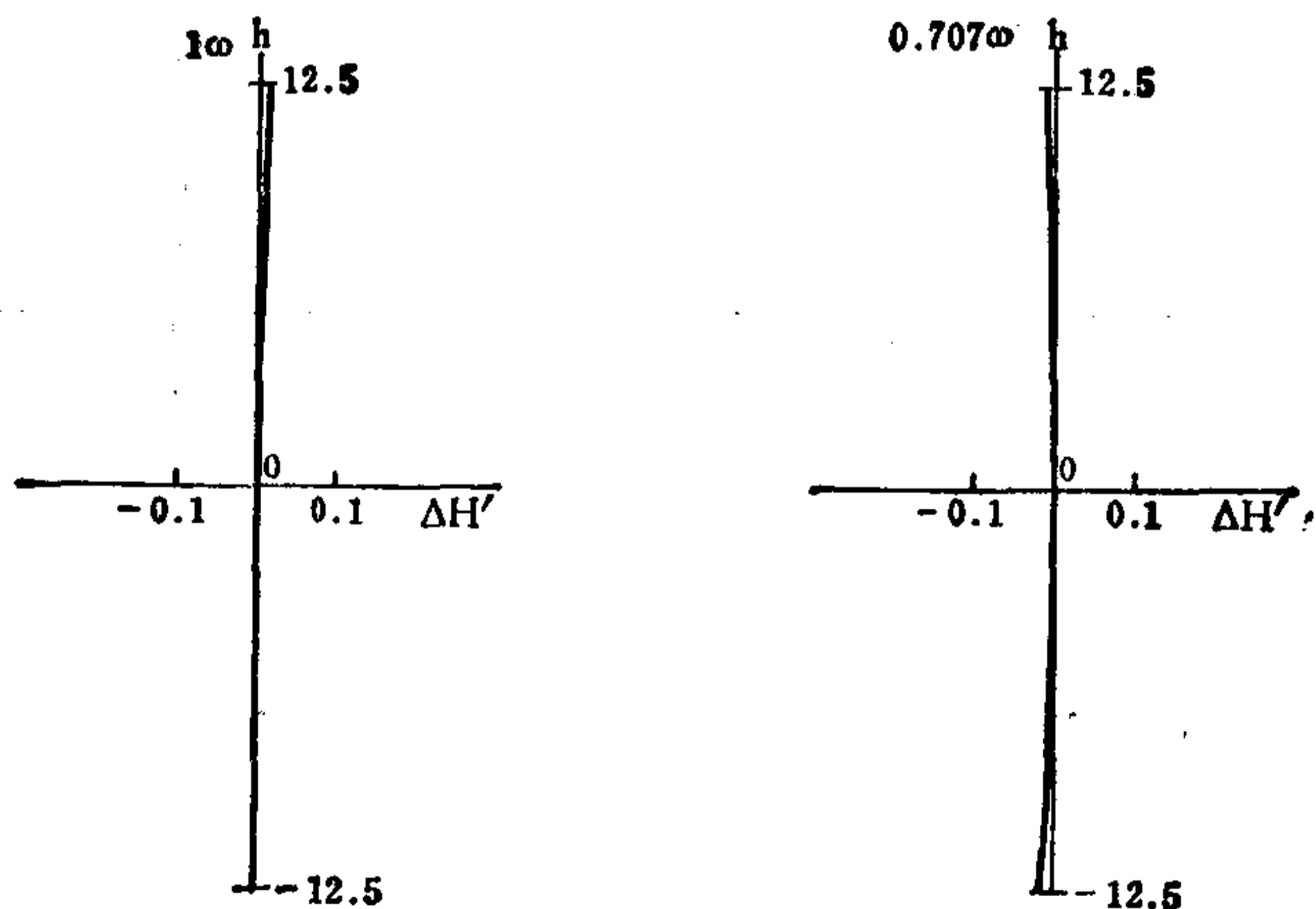
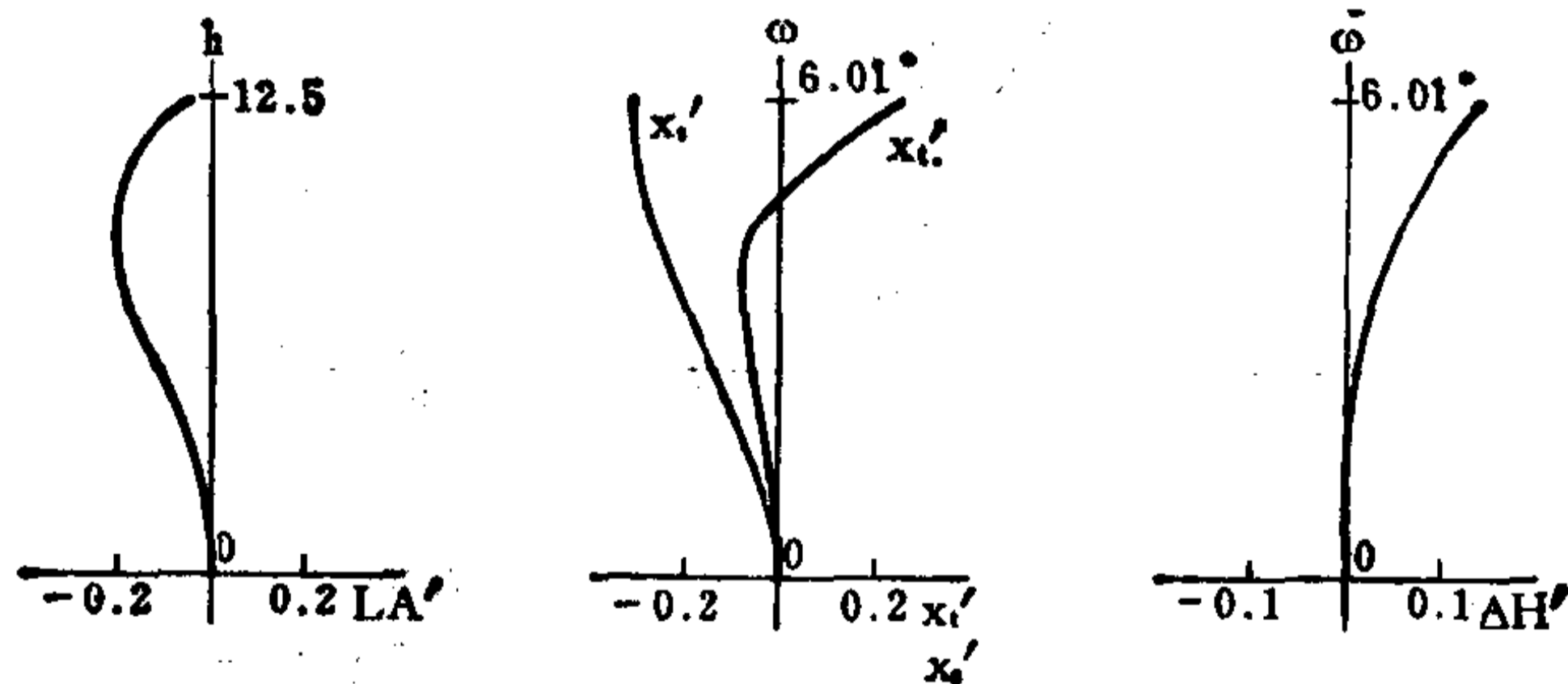

编号: 05-04-081

三组元物镜

E.F.L=81.15 B.F.L=61.68 FNo. = 5 F.A. = ±3°** L'p1 = -24.4

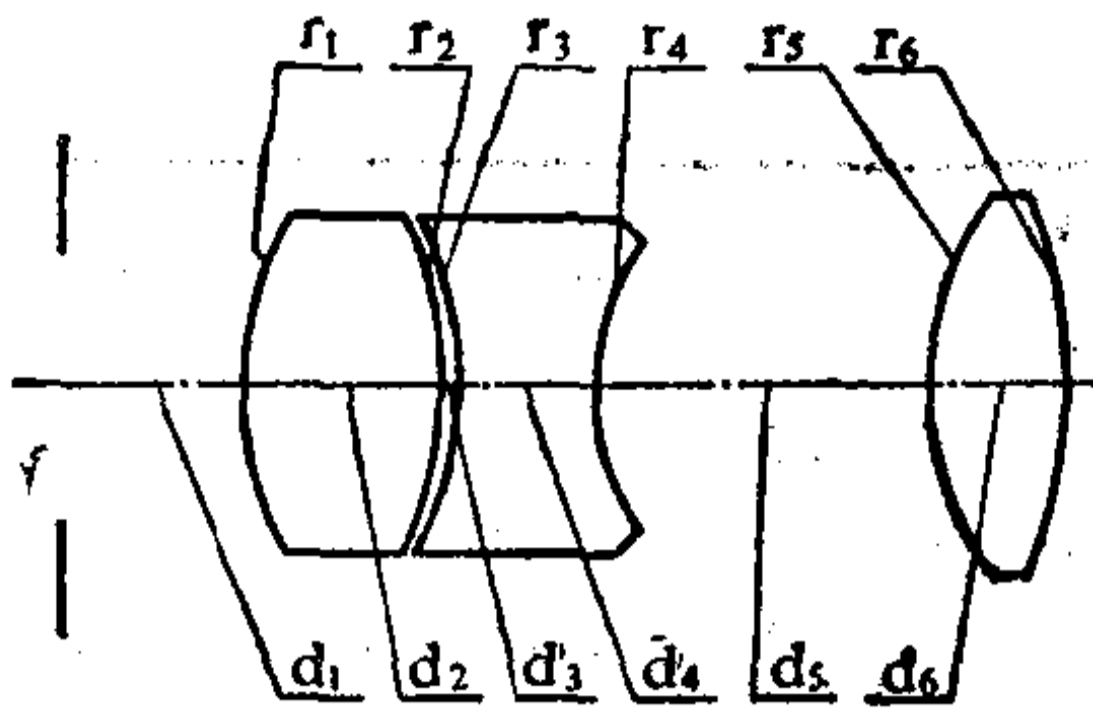

序号	r	d	n _D	v _D	序号	r	d	n _D	v _D
		24.40*			4	31.4	43.00		
1	44.1	24.90	1.49	57.4	5	41.5	16.80	1.49	57.4
2	-52.4	1.41			6	-62.5			
3	-45.9	18.40	1.57	36.6					

	ΣS ₁	ΣS ₂	ΣS ₃	ΣS ₄	ΣS ₅	HI	QP(1 ω)
	-0.0194	-0.0210	-0.0219	-0.0013	-0.0261	4.2	-3.2%
h 或 ω %	LA'	ΔH'	x _t	x _s	x _t - x _s	K' _{T1}	K' _{T0.7}
100	-0.997	-0.137	-3.441	-1.203	-2.238	-0.4172	-0.1973
70	-0.492	-0.047	-1.702	-0.592	-1.110	-0.2675	-0.1273

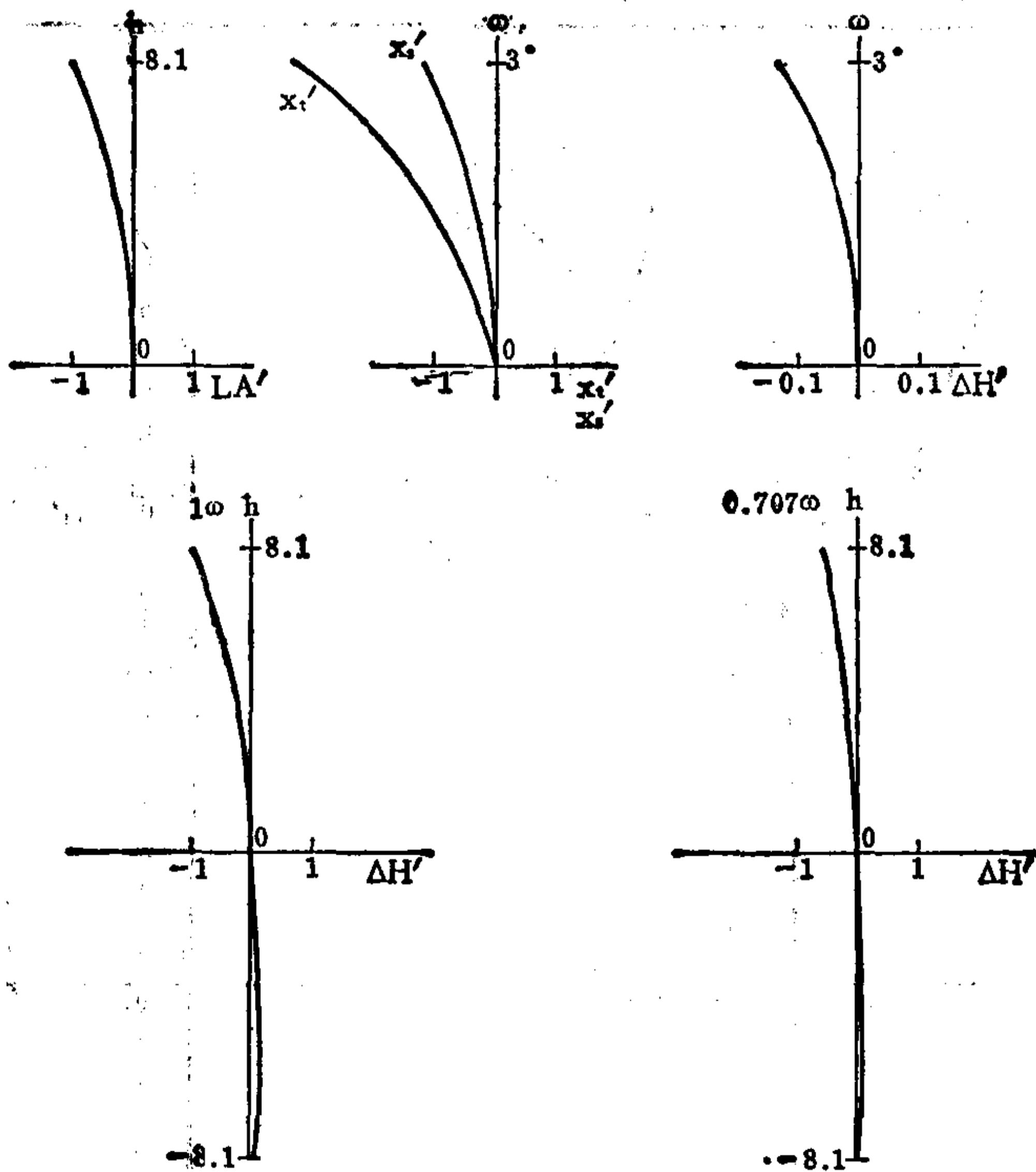

编号: 05-04-082

三组元物镜

E.F.L=73.0 B.F.L=45.62 FNo.=5.6 F.A.=±4.6°** L'PI=-11.5

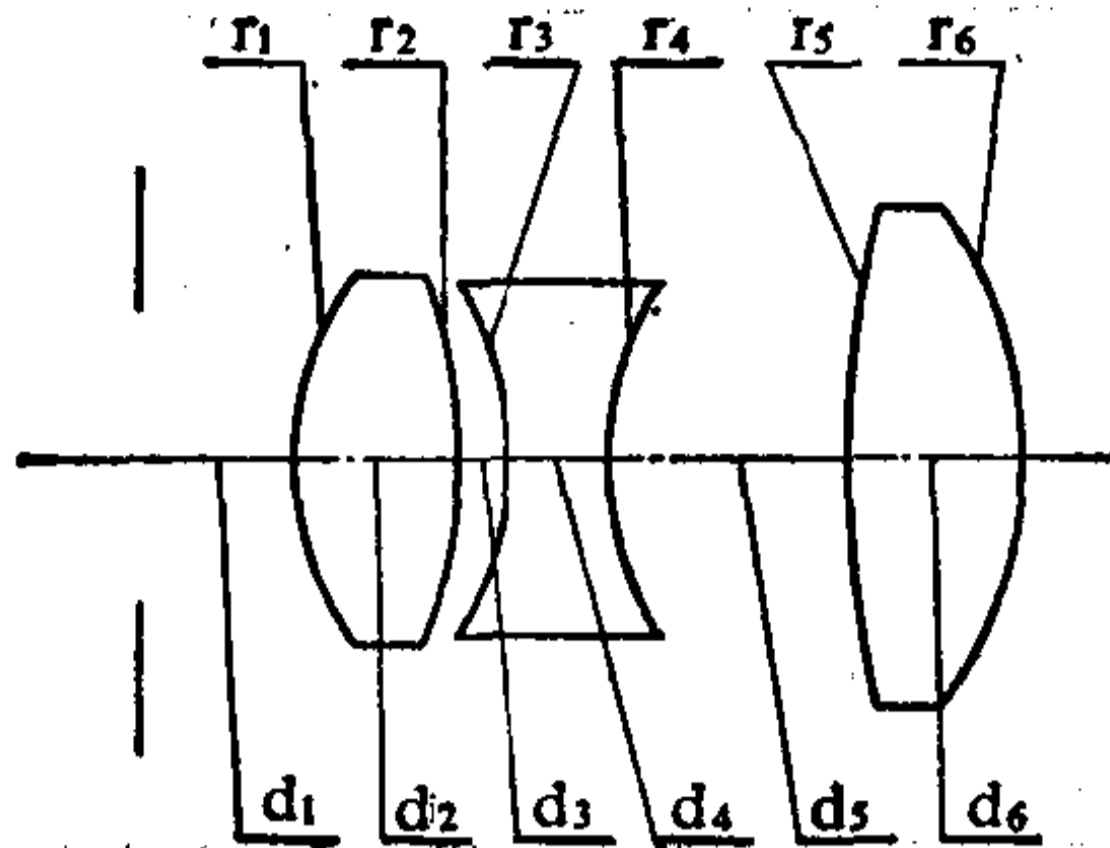

序号	r	d	n _D	v _D	序号	r	d	n _D	v _D
1	23.0	11.7	1.49	57.4	4	24.4	16.8		
2	-37.4	3.2			5	84.2	12.3	1.49	57.4
3	-24.5	7.7	1.57	36.6	6	-30.8			

	ΣS ₁	ΣS ₂	ΣS ₃	ΣS ₄	ΣS ₅	HI	QP(1 ω)
	-0.01217	-0.00943	-0.00549	-0.00215	-0.00444	5.8	-0.4%
h 或 ω %	LA'	ΔH'	x _t	x _s	x _t - x _s	K _{T1}	K _{T0.7}
100	-0.694	-0.025	-1.179	-0.484	-0.695	-0.1584	-0.0806
70	-0.366	-0.009	-0.589	-0.242	-0.347	-0.1105	-0.0563

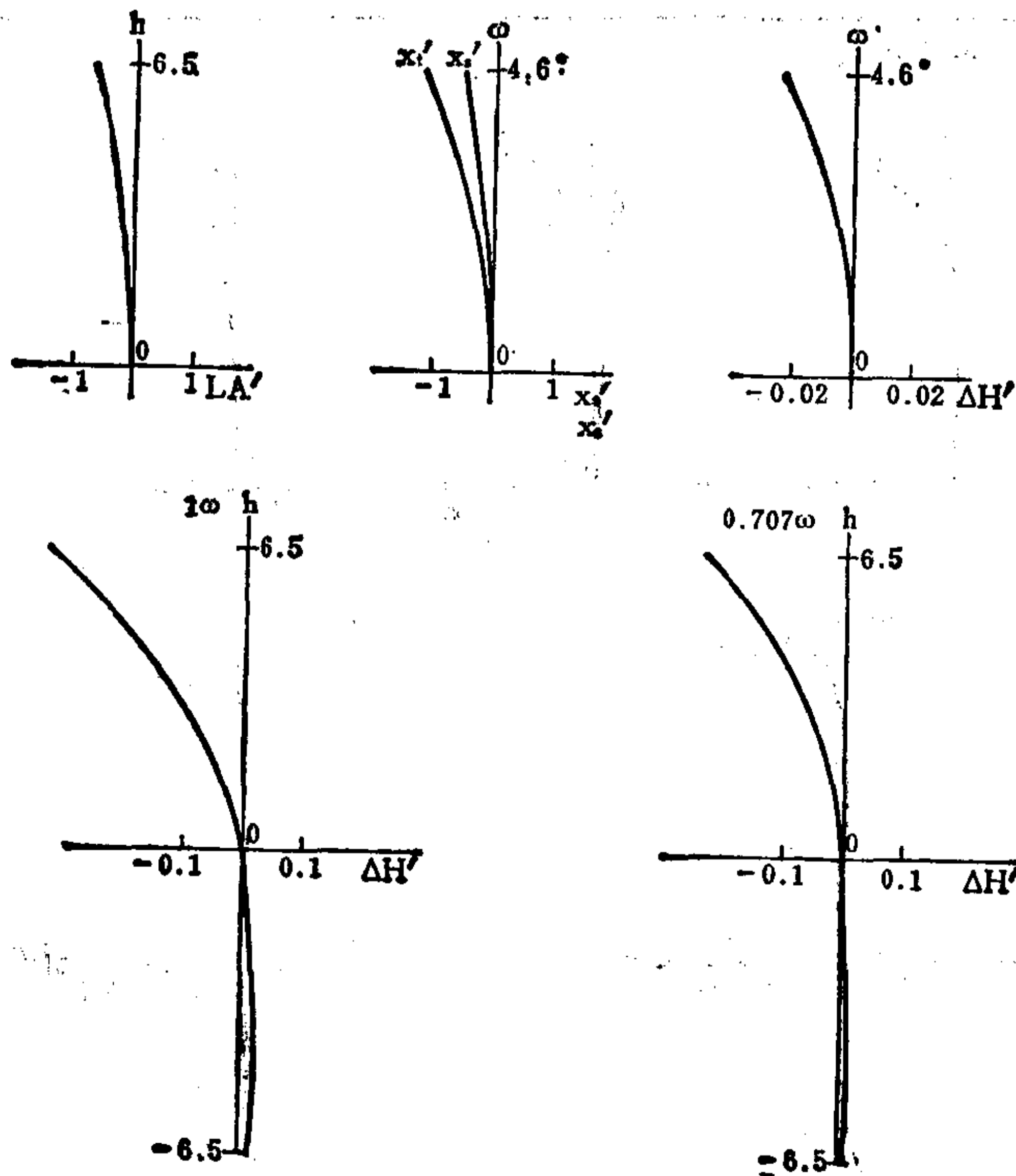

编号: 05-04-083

倒置的高斯型对称复印透镜系统

E. F. L = 100

B. F. L = 85.182

FNo. = 4.5

F. A. = $\pm 20^{\circ}$ **

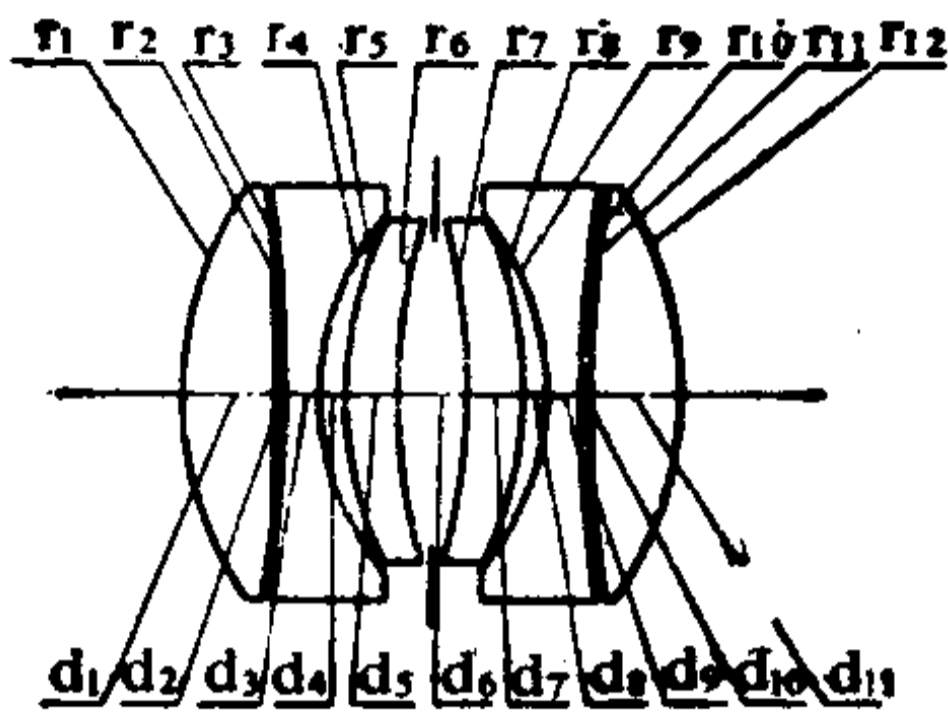

序号	r	d	n _D	v _D	序号	r	d	n _D	v _D
1	23.893	6.020	1.6110	57.2	7	-40.717	3.540	1.5230	50.5
2	-94.764	0.048			8	-26.007	1.470		
3	-94.764	2.600	1.5497	45.8	9	-17.670	2.600	1.5497	45.8
4	17.670	1.470			10	94.764	0.048		
5	26.007	3.540	1.5230	50.5	11	94.764	6.020	1.6110	57.2
6	40.717	4.220*			12	-23.893			

4.220* = 2.110 + 2.110

	ΣS_1	ΣS_2	ΣS_3	ΣS_4	ΣS_5	HI	QP(1 ω)
	-0.0243	-0.0217	0.0037	-0.0240	0.0091	36.5	0.15%
h 或 ω %	LA'	$\Delta H'$	x_t	x'_t	$x_t - x'_t$	K'_{f1}	$K'_{f0.7}$
100	1.1534	0.0549	-0.395	-0.479	0.084	-0.3635	-0.1557
70	-0.0546	0.0172	-0.233	-0.342	0.109	-0.3861	-0.1265

注: 以上象差值是按 $l = -\infty$ 计算的。

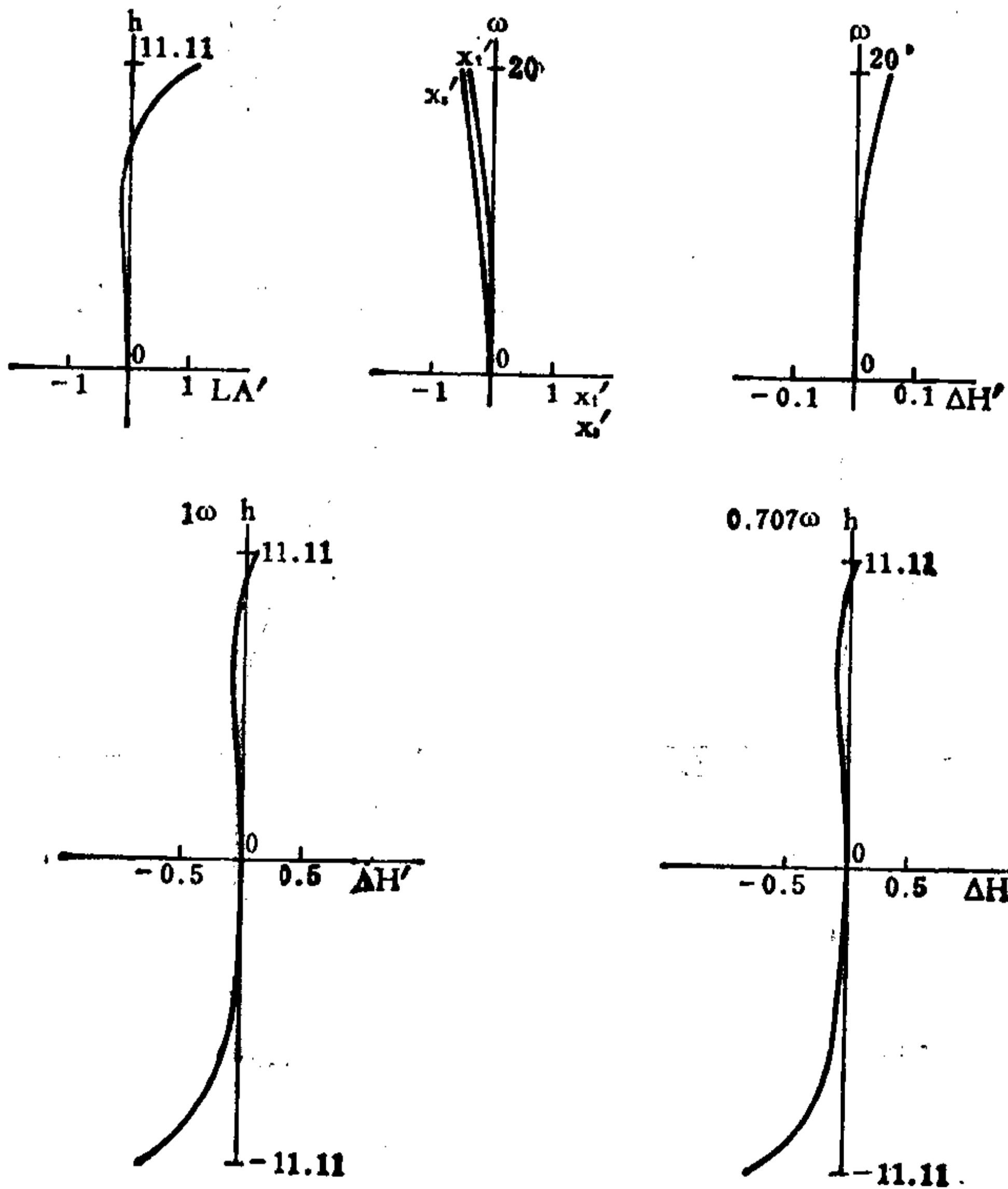

编号: 05-04-084

四组元对称投影物镜

E. F. L = 148.56

B. F. L = 129.56

FNo. = 5.6

F. A. = $\pm 20^{\circ}$ **

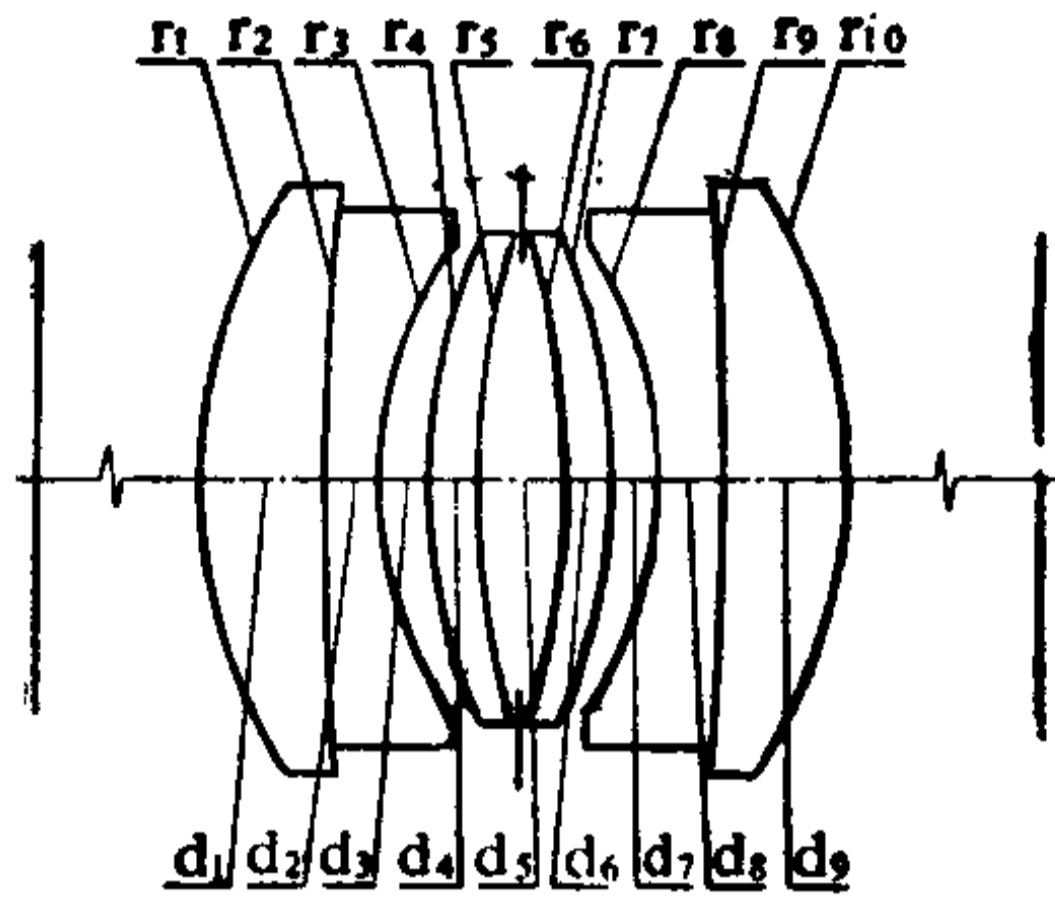

序号	r	d	n _D	v _D	序号	r	d	n _D	v _D
1	35.98	7.81	1.670	47.2	6	-58.73	3.14	1.638	55.5
2	313.33	4.11	1.605	38.0	7	-39.50	3.19		
3	27.20	3.19			8	-27.20	4.11	1.605	38.0
4	39.50	3.14	1.638	55.5	9	-313.33	7.81	1.670	47.2
5	58.73	5.30*			10	-35.98			

5.30* = 2.65 + 2.65

	ΣS_1	ΣS_2	ΣS_3	ΣS_4	ΣS_5	HI	QP(1 ω)
	-0.02043	-0.01567	-0.00047	-0.01837	0.00594	54.2	0.08%
h 或 ω %	LA'	$\Delta H'$	x'_t	x_s	$x'_t - x'_s$	K'_{T1}	$K_{T0.7}$
100	0.035	0.044	-0.718	-0.634	-0.084	-0.2769	-0.1379
70	-0.352	0.014	-0.516	-0.476	-0.040	-0.2320	-0.1018

注: 1. 物点 = 278.16, 象点 = 278.16;

2. 以上象差值是按 $l = -\infty$ 计算的。

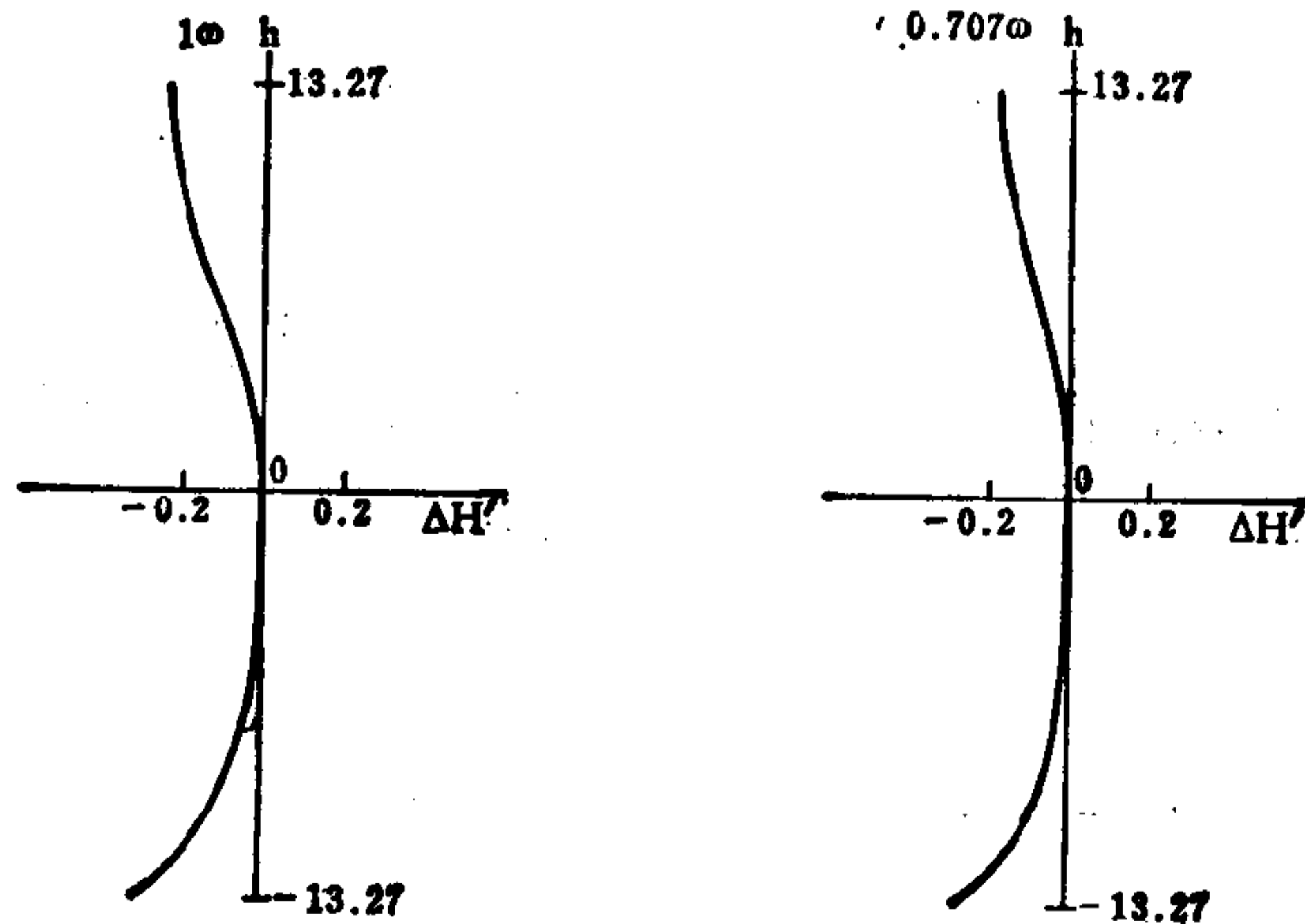
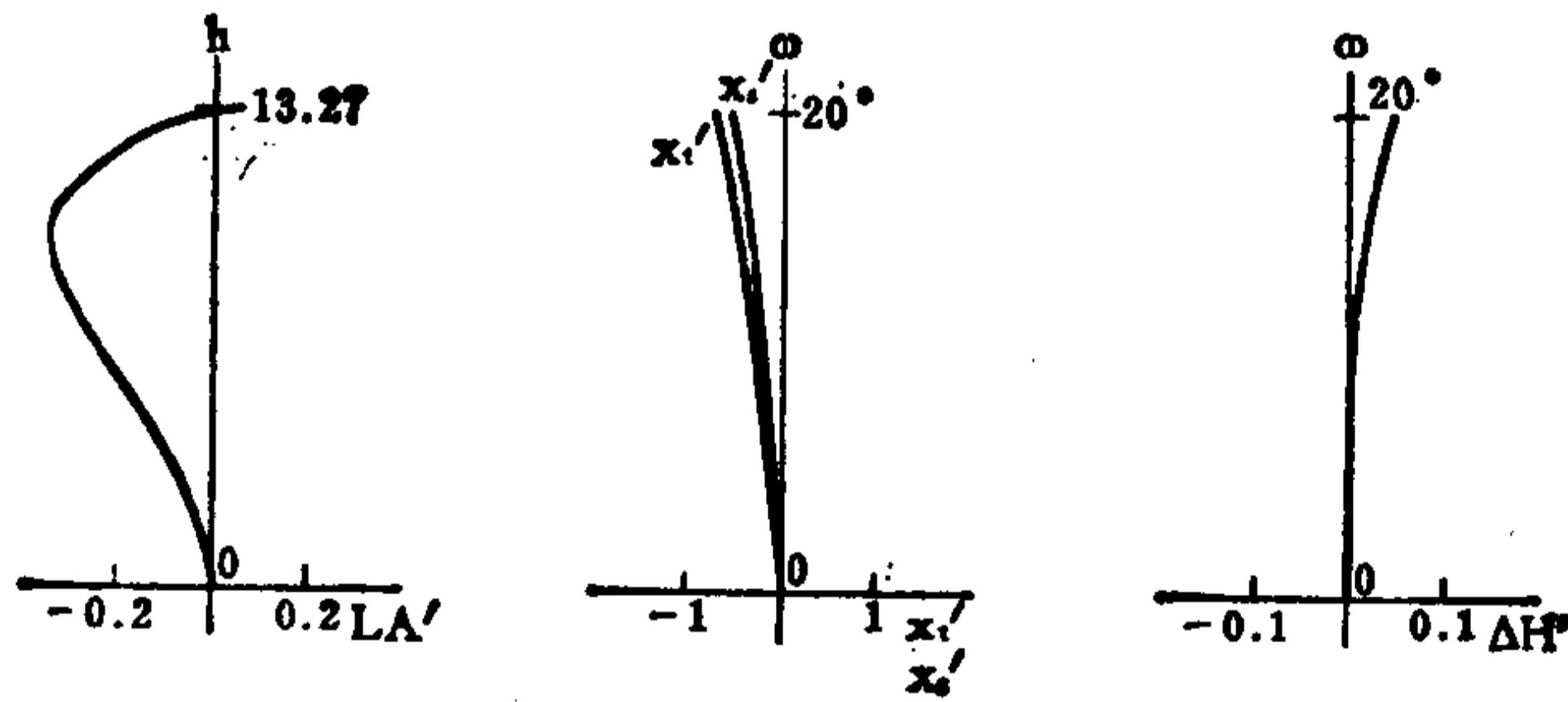

编号: 05-04-085

大倍率远摄照相镜头

E. F. L = 0.9993

B. F. L = 0.2031

FNo. = 4

F. A. = $\pm 4'^{**}$

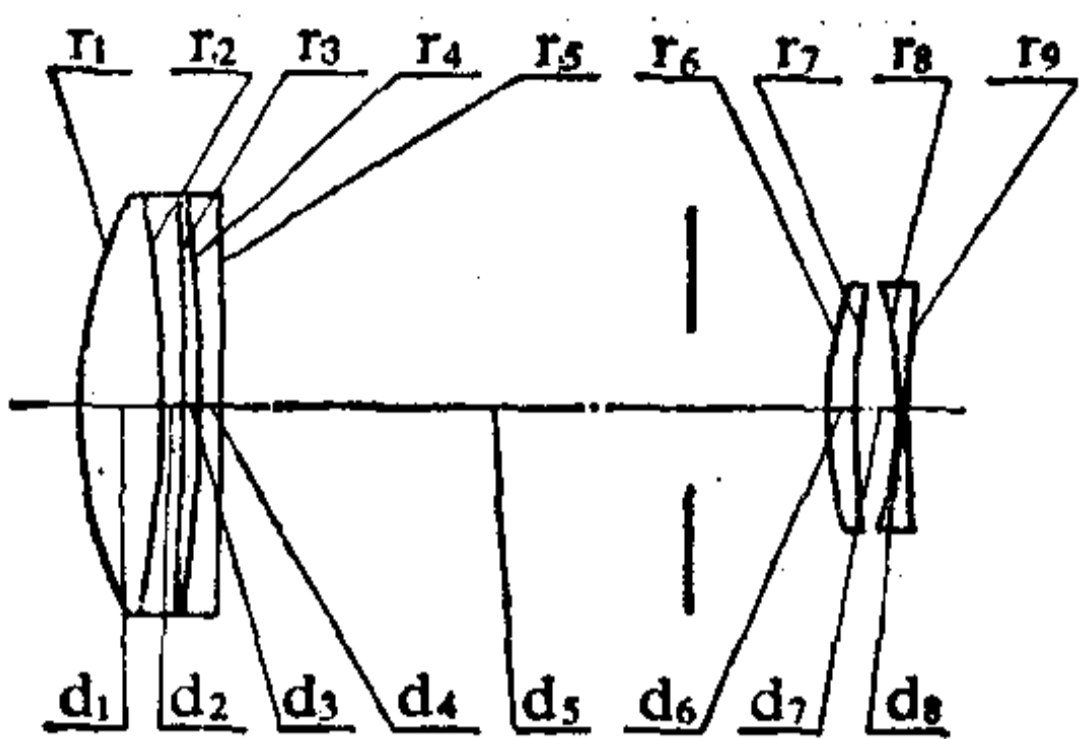

序号	r	d	n_d	v_d	序号	r	d	n_d	v_d
1	0.42156	0.06676	1.64250	58.09	5	0.34202	0.02234	1.75787	31.56
2	-0.88214	0.01945	1.72830	28.66	7	1.17496	0.03859		
3	-18.00073	0.01183			8	-0.31069	0.00529	1.65016	39.31
4	-1.37288	0.01945	1.65446	33.79	9	0.69782			
5	-5.30649	0.52203*							

$0.52203^* = 0.40290 + 0.11913$

	ΣS_1	ΣS_2	ΣS_3	ΣS_4	ΣS_5	HI	QP(1 ω)
	-0.000112	0.000083	-0.000061	0.000018	0.000139	0.07	0.75%
h 或 ω %	LA'	$\Delta H'$	x'_t	x_s	$x'_t - x_s$	K'_{T1}	$K'_{T0.7}$
100	-0.00254	0.00053	-0.00327	-0.00098	-0.00229	-0.00061	-0.00002
70	-0.00155	-0.00019	-0.00215	-0.00059	-0.00156	-0.00004	0.00013

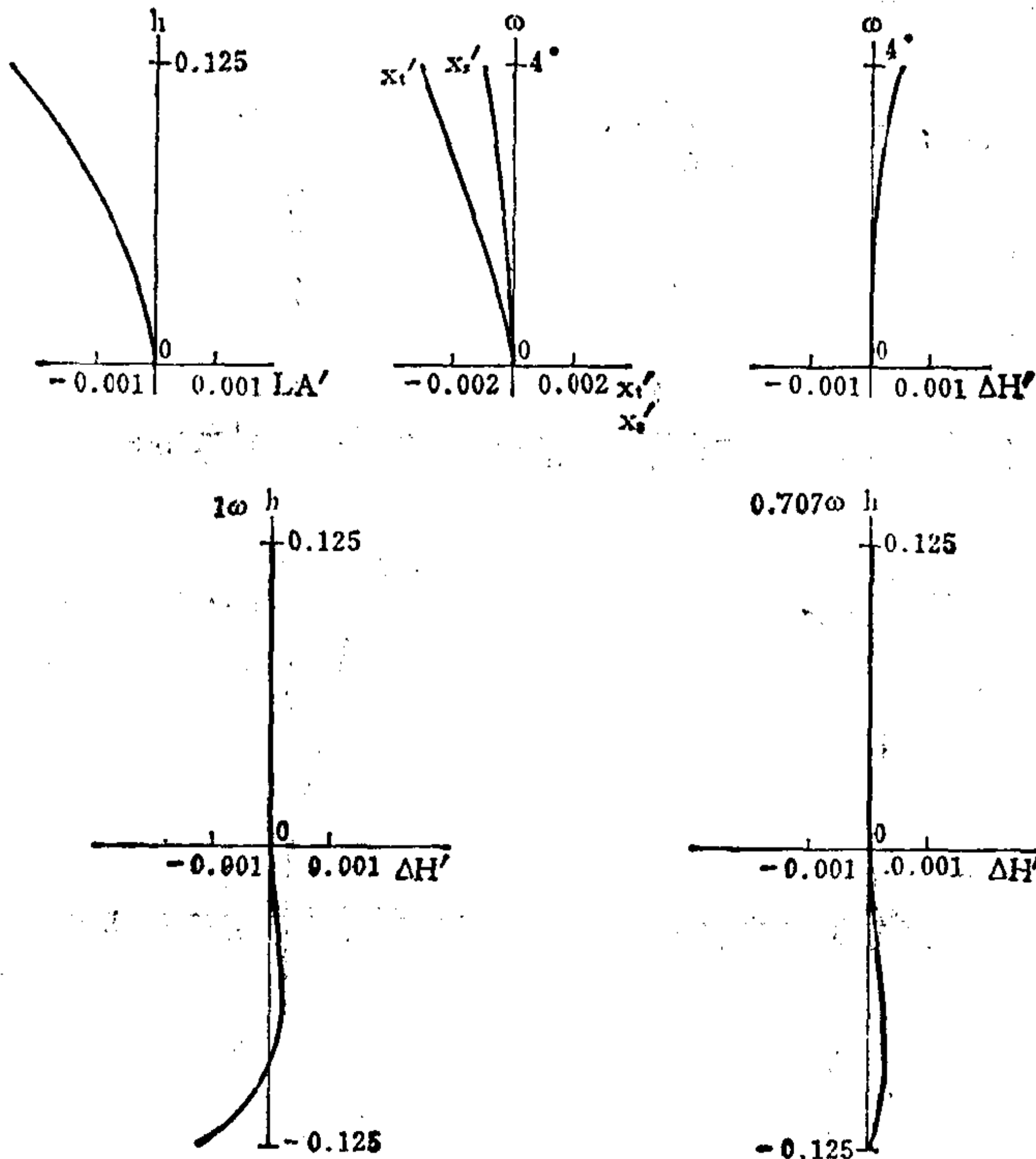

编号: 05-04-086

大倍率远摄照相镜头

E.F.L=1.0

B.F.L=0.2048

FNo. = 4

F.A. = ± 4°**

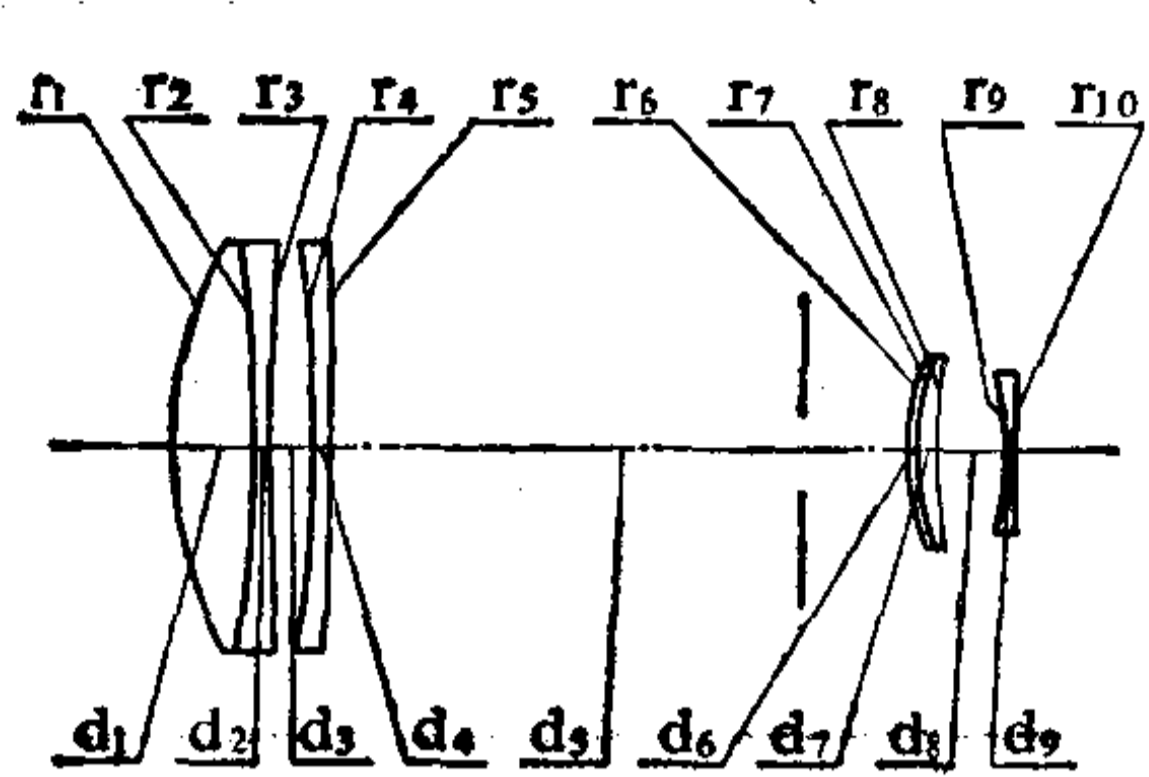

序号	r	d	n_d	ν_d	序号	r	d	n_d	ν_d
1	0.38711	0.06631	1.62041	60.29	6	0.23592	0.00631	1.85820	23.40
2	-1.12833	0.01263	1.72151	29.28	7	0.23592	0.01578	1.72372	38.09
3	14.40868	0.03789			8	0.46853	0.05962		
4	-1.33509	0.01579	1.65446	33.79	9	-0.27275	0.00579	1.65016	39.31
5	-31.54790	0.49388*			10	1.11156			

$0.49388^* = 0.40000 + 0.09388$

	ΣS_1	ΣS_2	ΣS_3	ΣS_4	ΣS_5	HI	QP(1 ω)
	-0.0000936	0.0000954	-0.0000648	0.0000207	0.0000639	0.07	0.3%
h 或 ω %	LA'	$\Delta H'$	x'_t	x'_s	$x'_t - x'_s$	K'_{T1}	$K'_{T0.7}$
100	-0.00201	0.00021	-0.00348	-0.00097	-0.00251	-0.00074	-0.00002
70	-0.00128	0.00008	-0.00228	-0.00060	-0.00168	-0.00004	0.000115

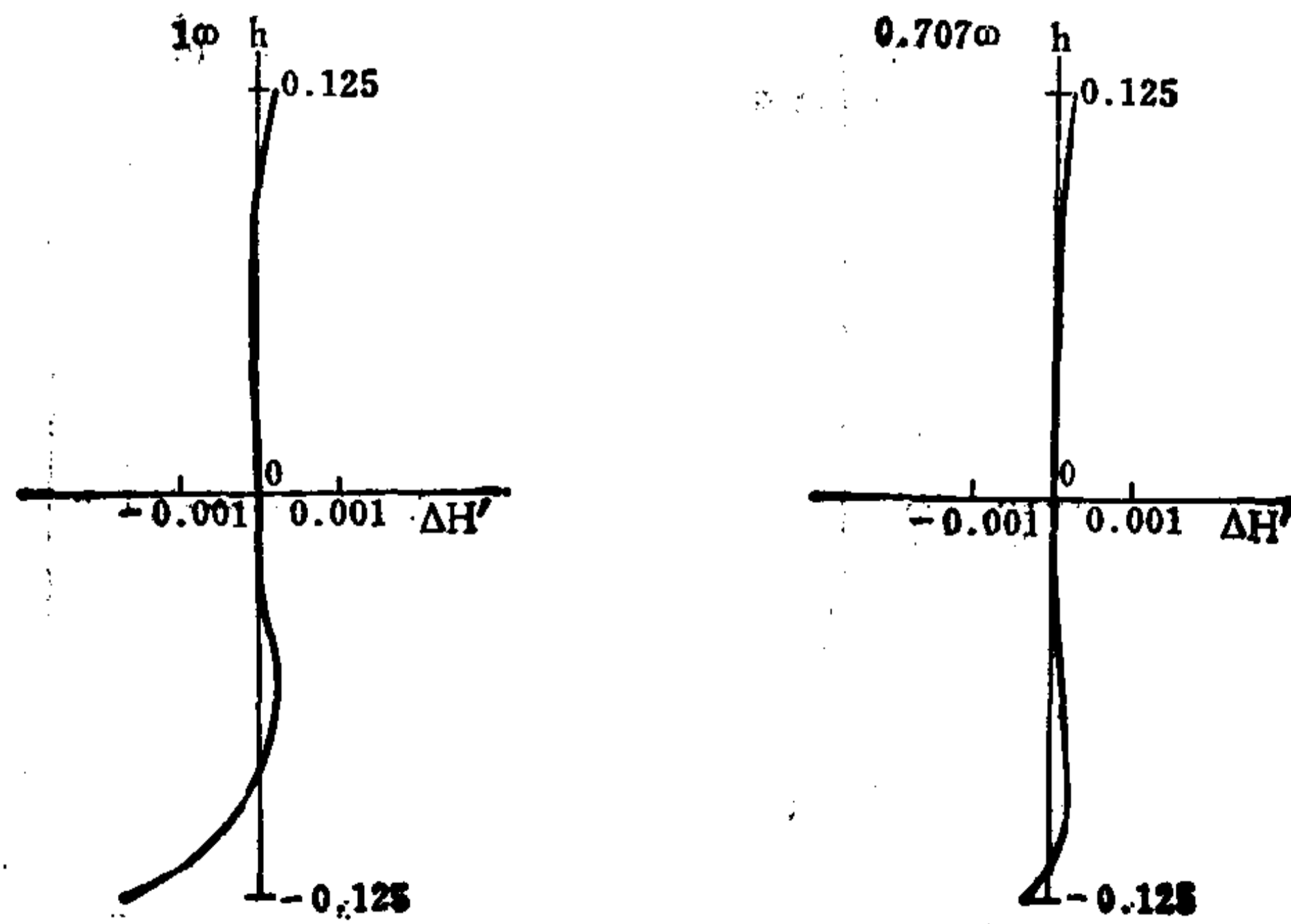
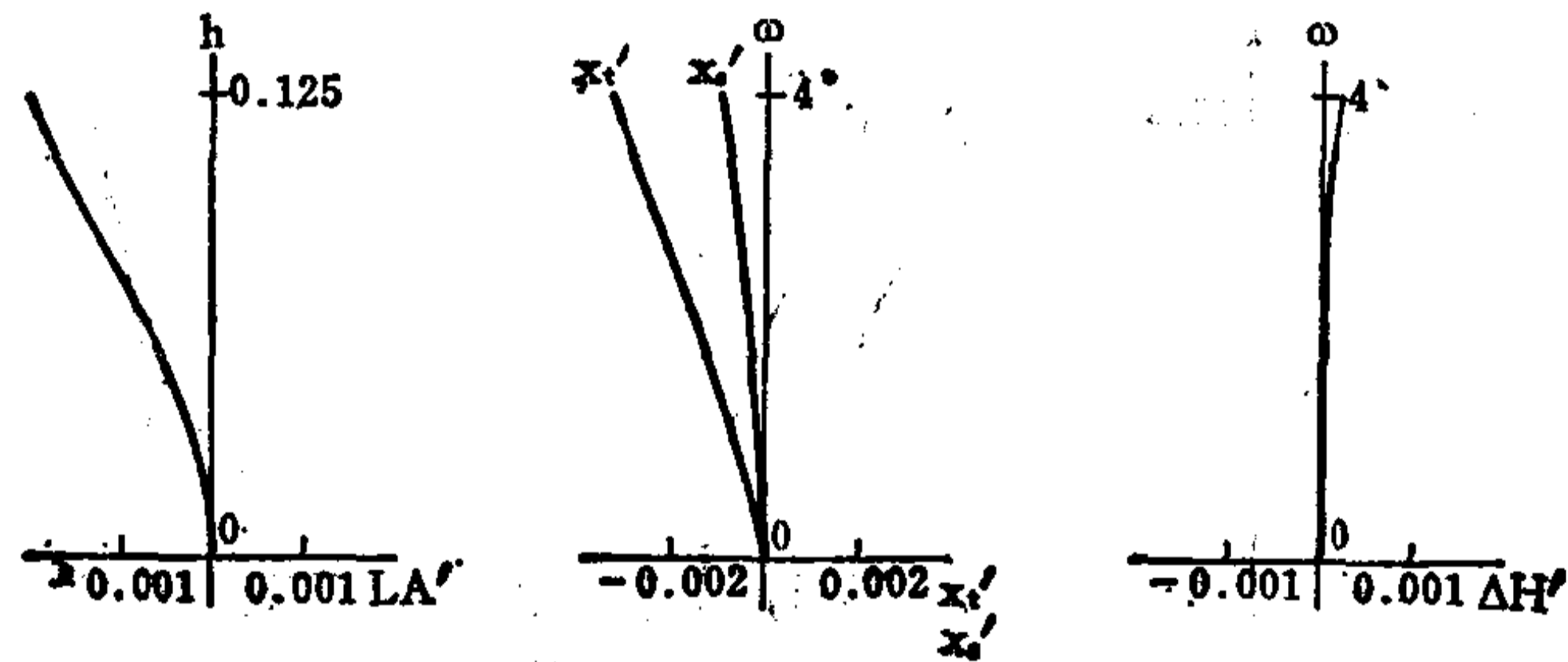

编号: 05-04-087

四组元摄影物镜

E. F. L = 100.65

B. F. L = 67.07

FNo. = 4

F. A. = ± 16°**

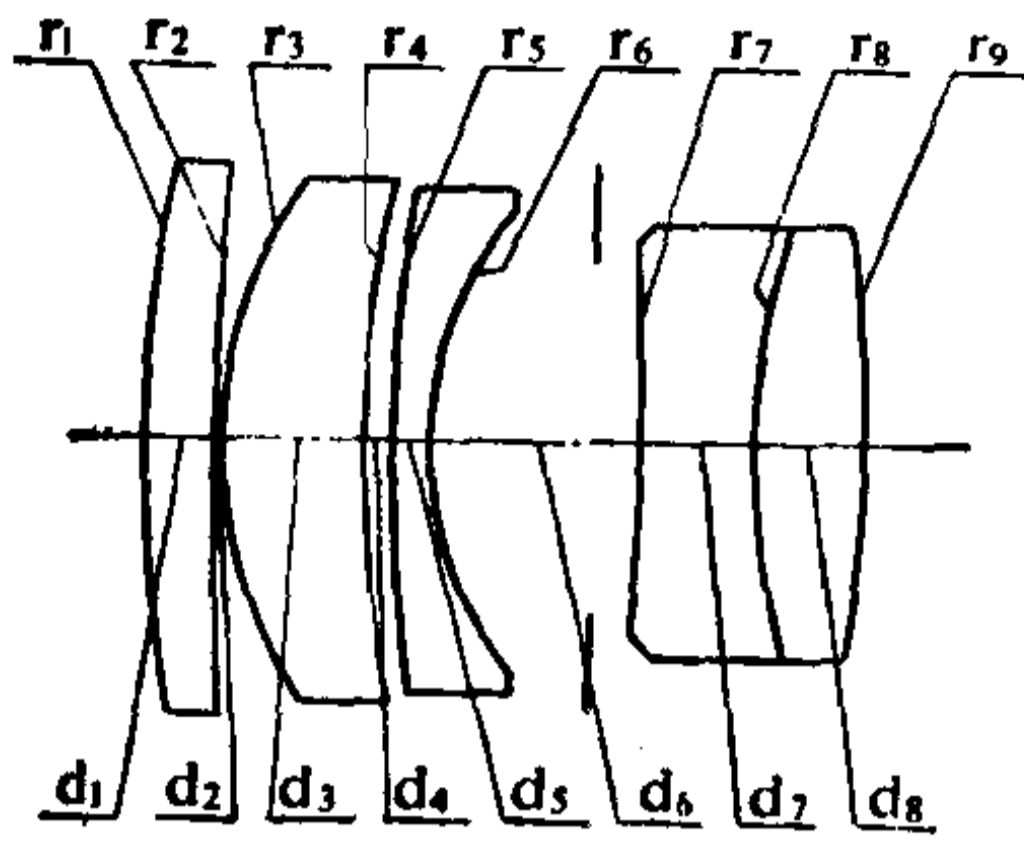

序号	r	d	n _D	v _D	序号	r	d	n _D	v _D
1	86.3	4.4	1.745	46.4	6	23.5	13.2*		
2	268.0	0.2			7	-214.0	7.5	1.513	60.5
3	29.4	9.3	1.734	51.0	8	47.8	6.9	1.697	56.2
4	71.5	2.0			9	-81.5			
5	145.0	2.4	1.720	29.3					

13.2* = 10.0 + 3.2

	ΣS ₁	ΣS ₂	ΣS ₃	ΣS ₄	ΣS ₅	HI	QP(1∞)
	-0.01316	0.00178	0.00437	-0.02219	0.02817	28.9	0.23%
h 或 ω %	LA'	ΔH'	x _t	x _s	x _t - x _s	K _{T1}	K _{T0.7}
100	-0.244	0.067	-0.188	-0.307	0.119	0.0648	0.0234
70	-0.172	0.033	-0.114	-0.229	0.115	0.0279	0.0129

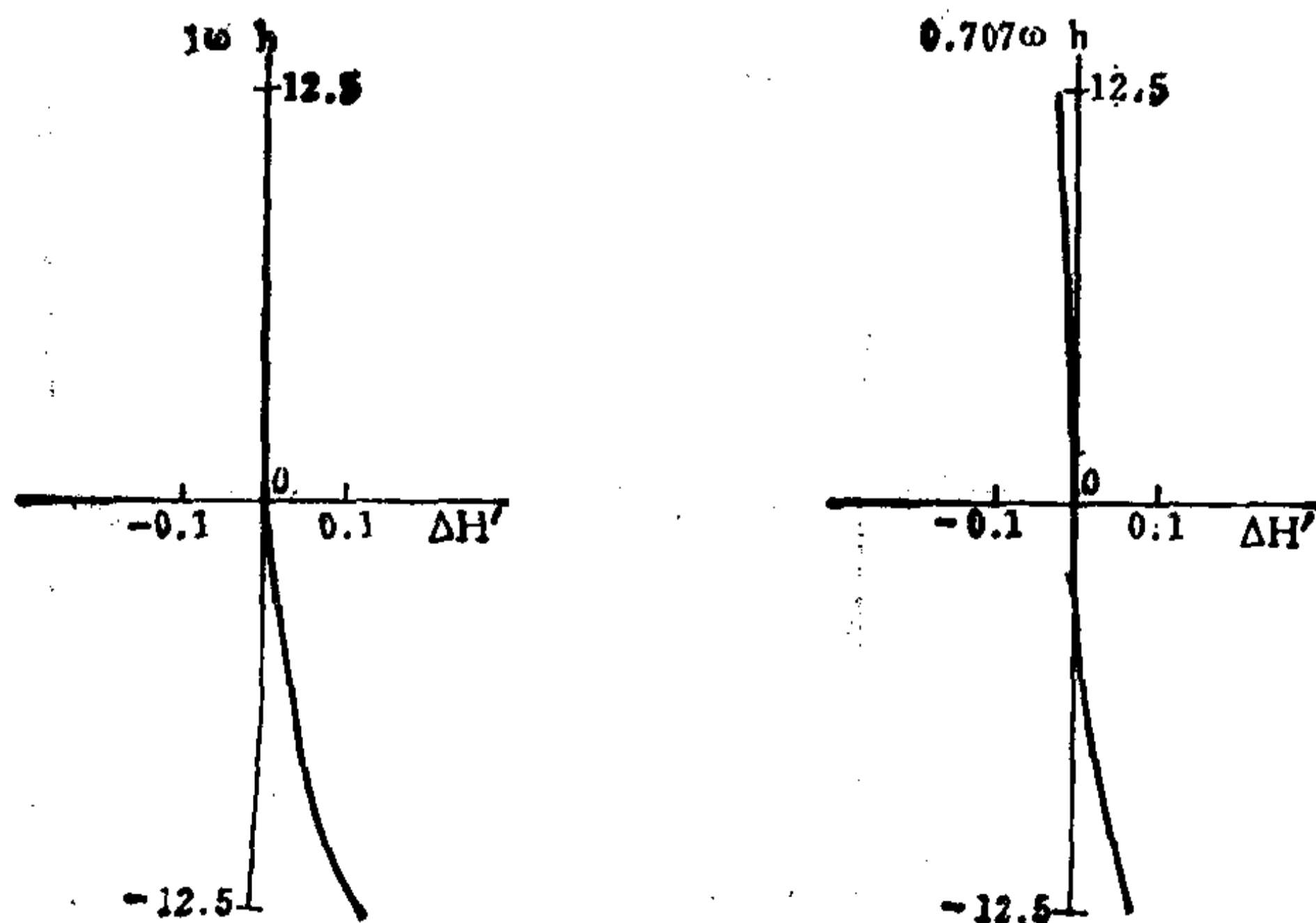
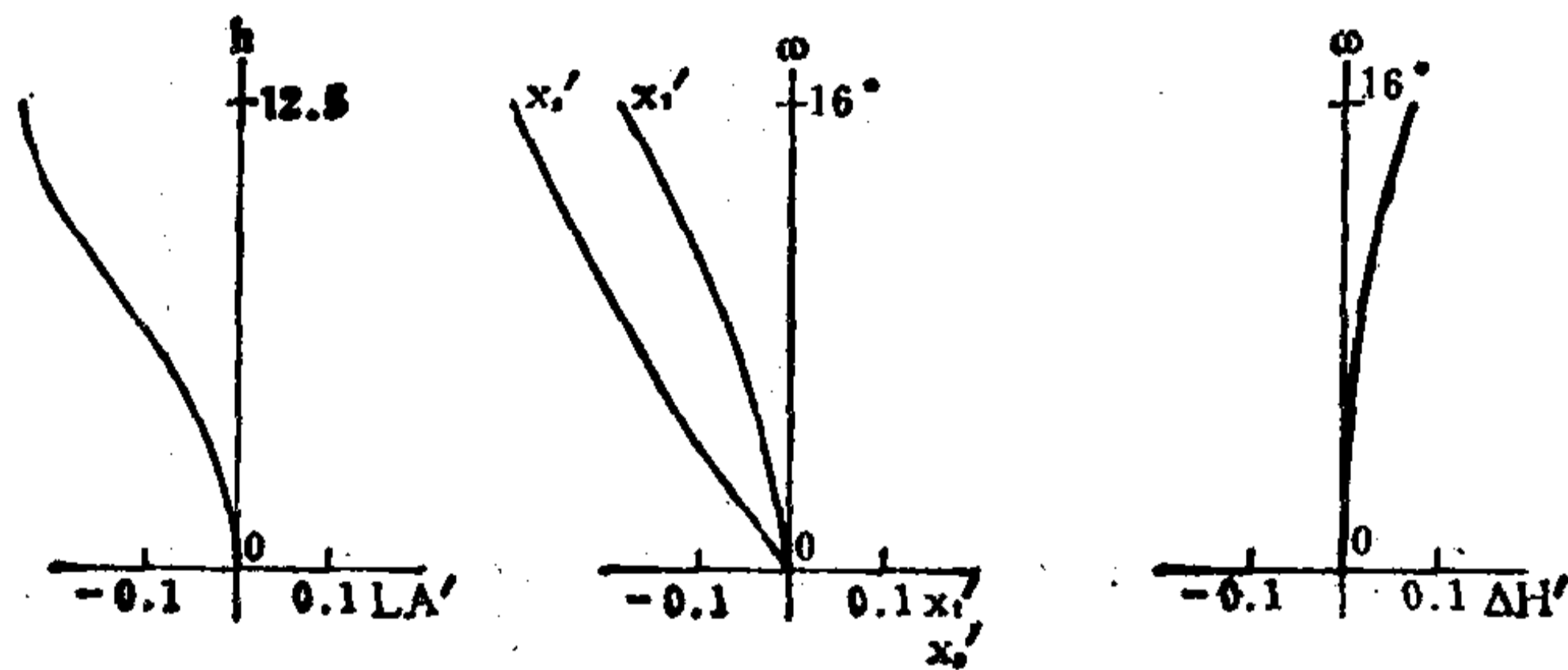

编号: 05-04-088

四组元摄影物镜

E. F. L = 99.5

B. F. L = 69.1

FNo. = 4**

F. A. = ± 16°**

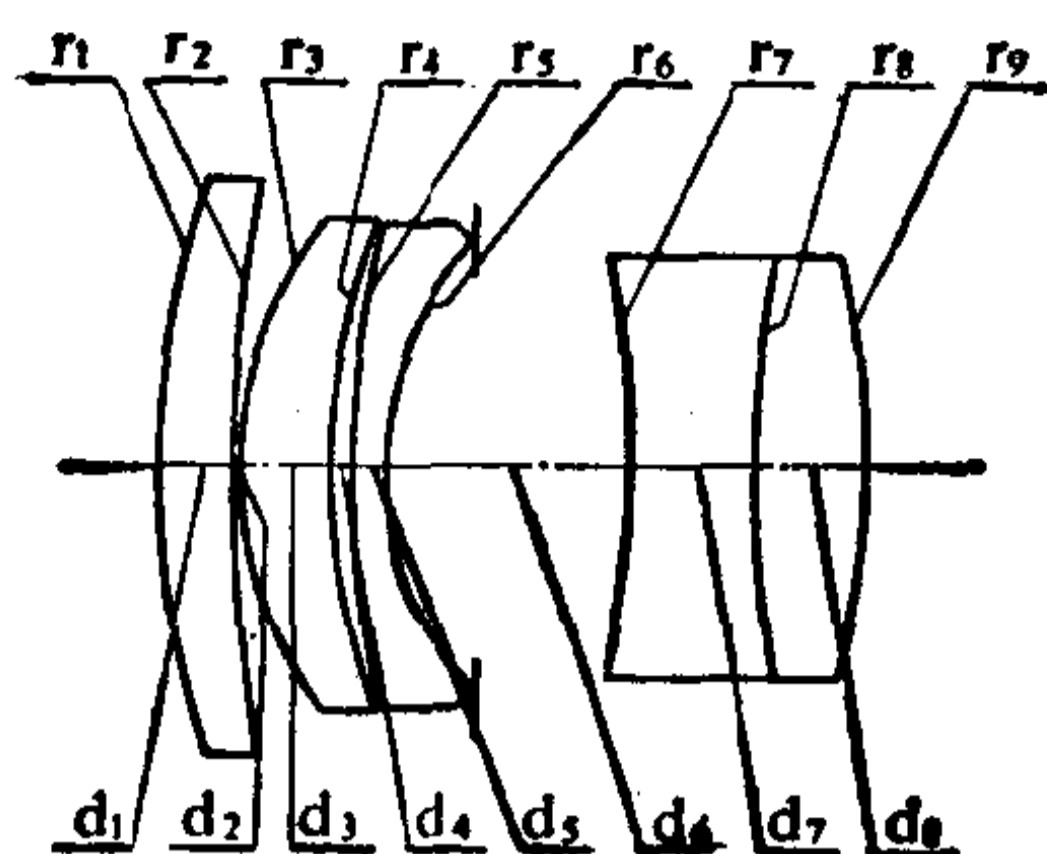

序号	r	d	n _D	v _D	序号	r	d	n _D	v _D
1	57.5	4.9	1.745	46.4	6	21.5	15.2*		
2	206.0	0.2			7	-67.8	8.2	1.528	51.6
3	26.6	5.7	1.734	51.0	8	63.5	7.2	1.697	56.2
4	44.7	1.1			9	-56.0			
5	67.5	2.5	1.720	29.3					

15.2° = 5.2 + 10.0

	ΣS ₁	ΣS ₂	ΣS ₃	ΣS ₄	ΣS ₅	HI	QP(1 ω)
	- 0.02013	- 0.00729	0.00324	- 0.02138	0.02458	28.6	0.3%
h 或 ω %	LA'	ΔH'	x _i '	x _s '	x _i ' - x _s '	K _{T1}	K _{T0.7}
100	- 0.432	0.087	- 0.251	- 0.343	0.092	0.0682	- 0.0042
70	- 0.273	0.034	- 0.155	- 0.237	0.082	0.0379	- 0.0071

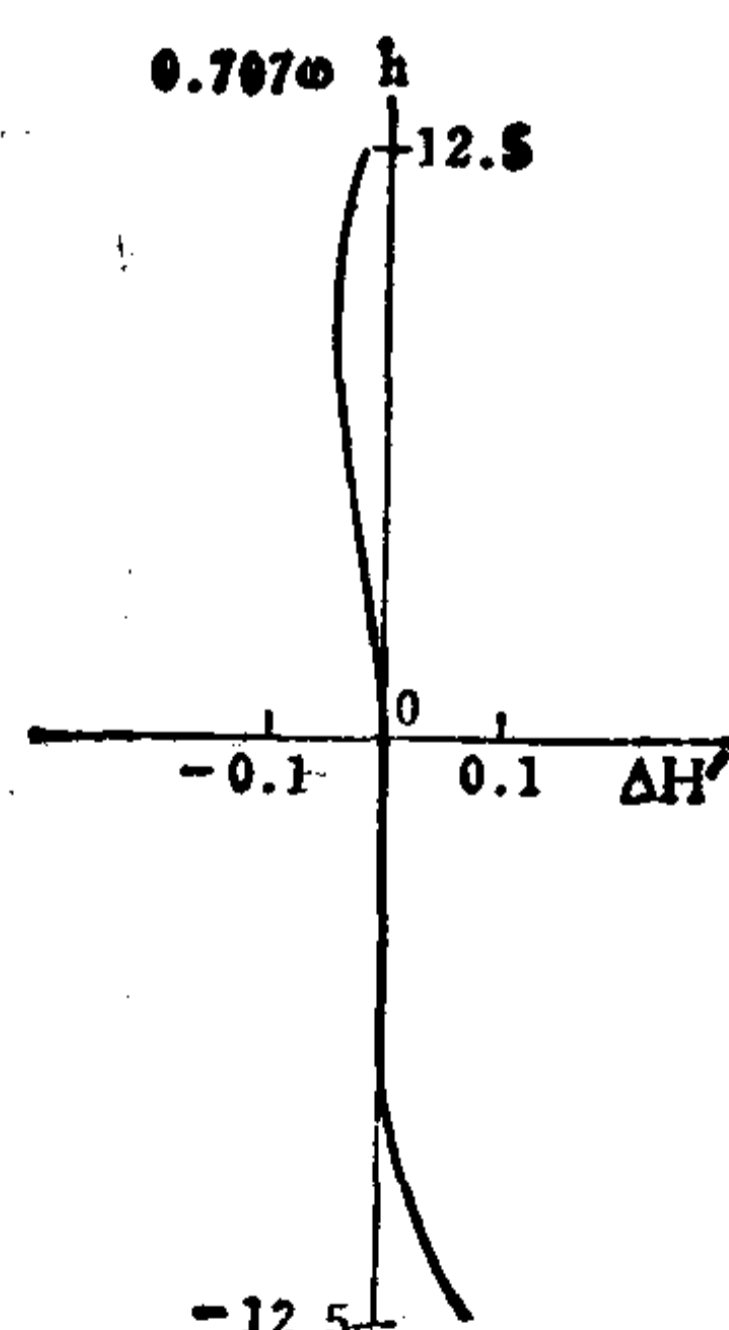
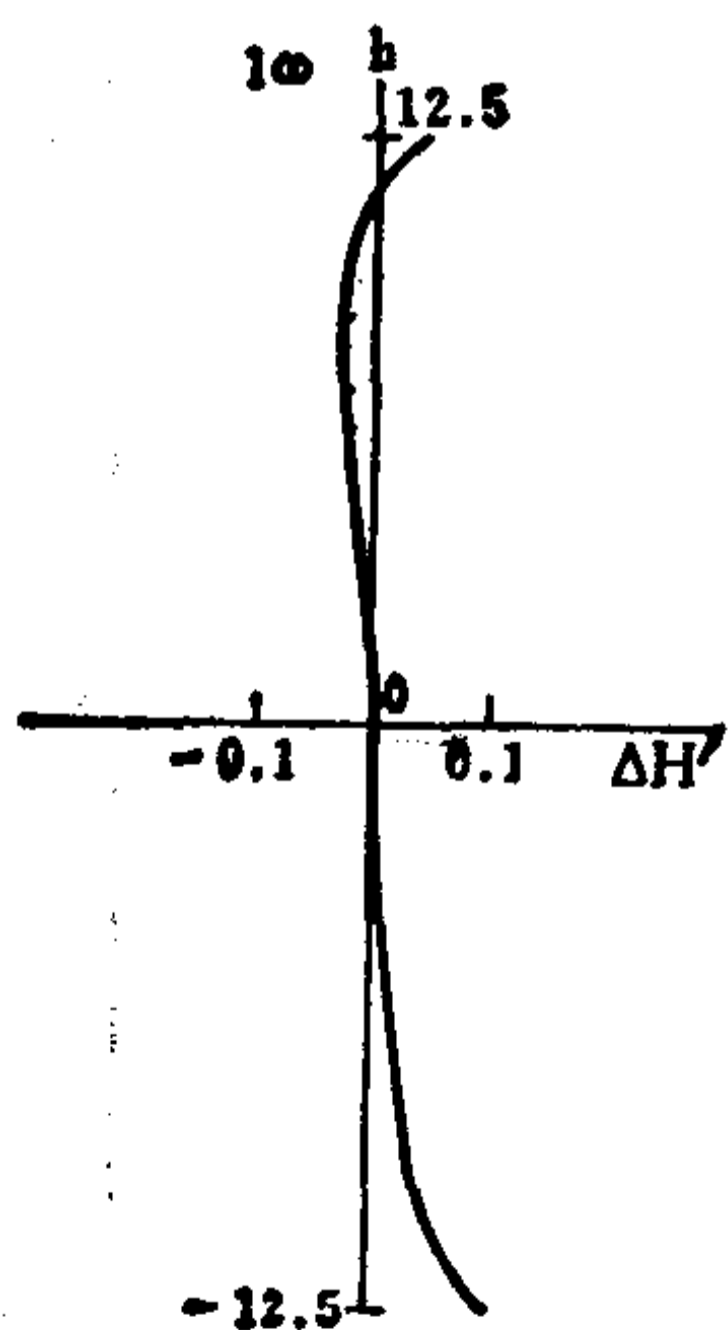
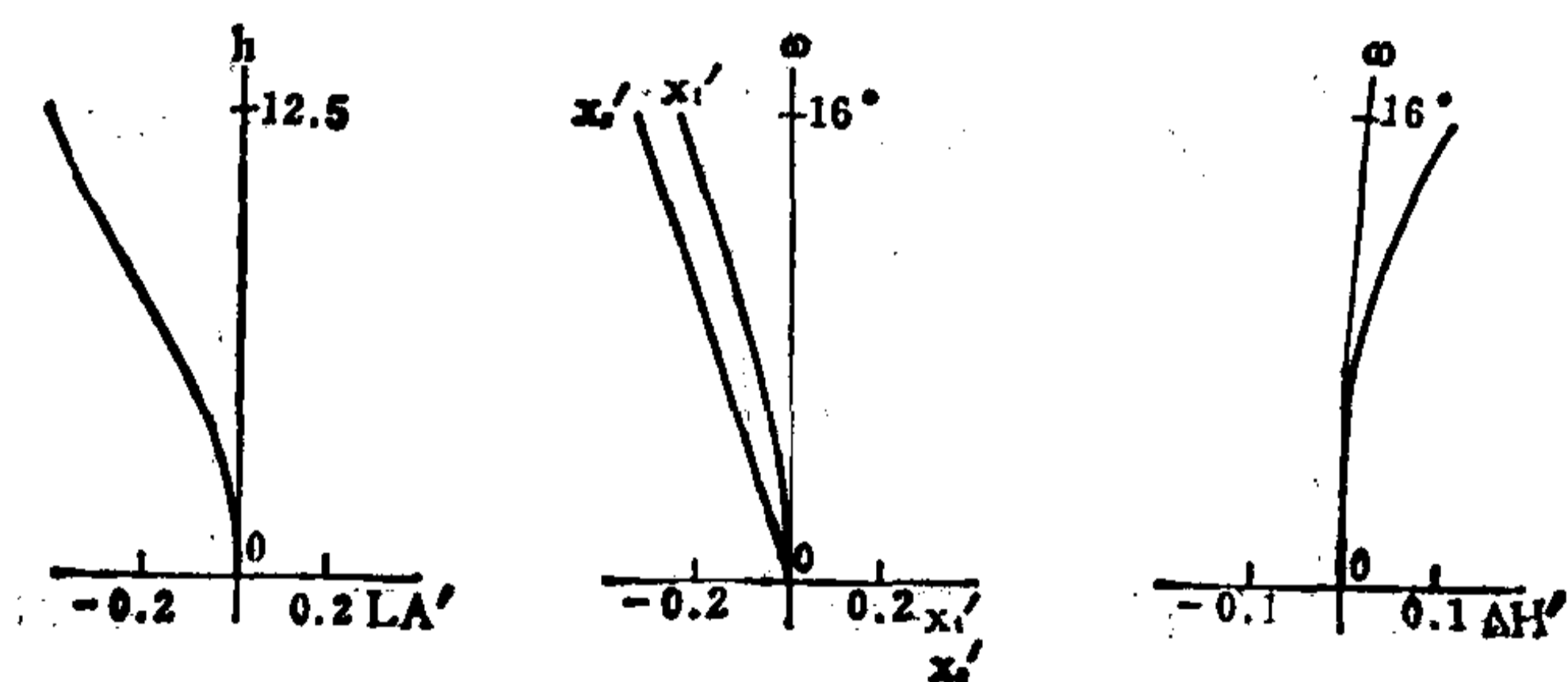

编号: 05-04-089

四组元高斯型摄影物镜

E.F.L=101.9 B.F.L=52.9 FNo.=5.7 F.A.=±14.9°**

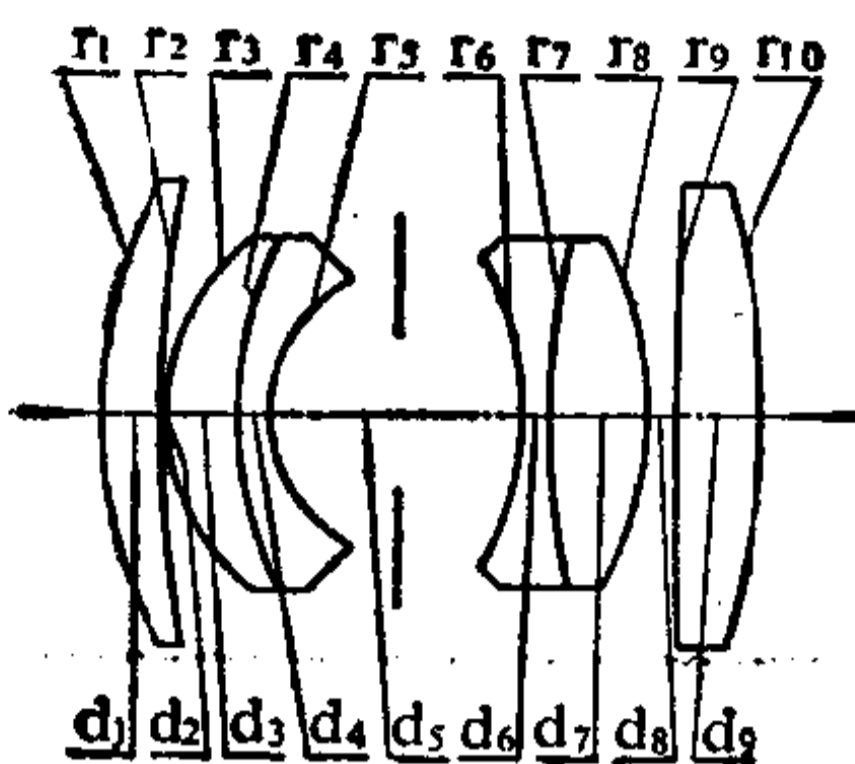

序号	r	d	nd	vd	序号	r	d	nd	vd
1	62.5	7.9	1.744	45.6	6	-41.5	3.5	1.672	32.2
2	164.0	0.4			7	99.5	12.0	1.744	43.9
3	28.7	9.4	1.697	56.2	8	-47.6	4.0		
4	51.2	3.5	1.689	30.9	9	807.0	11.0	1.734	51.0
5	19.3	32.4*			10	-103.0			

32.4* = 16.2 + 16.2

	ΣS_1	ΣS_2	ΣS_3	ΣS_4	ΣS_5	HI	QP(1 ω)
	0.00199	0.00094	0.00304	-0.00793	-0.00712	27.1	-0.18%
h 或 ω %	LA'	$\Delta H'$	x'_t	x'_s	$x'_t - x'_s$	K'_{T1}	$K'_{T0.7}$
100	0.169	-0.050	0.043	-0.208	0.251	-0.00481	-0.00429
70	0.074	-0.016	0.041	-0.132	0.173	0.00848	0.00258

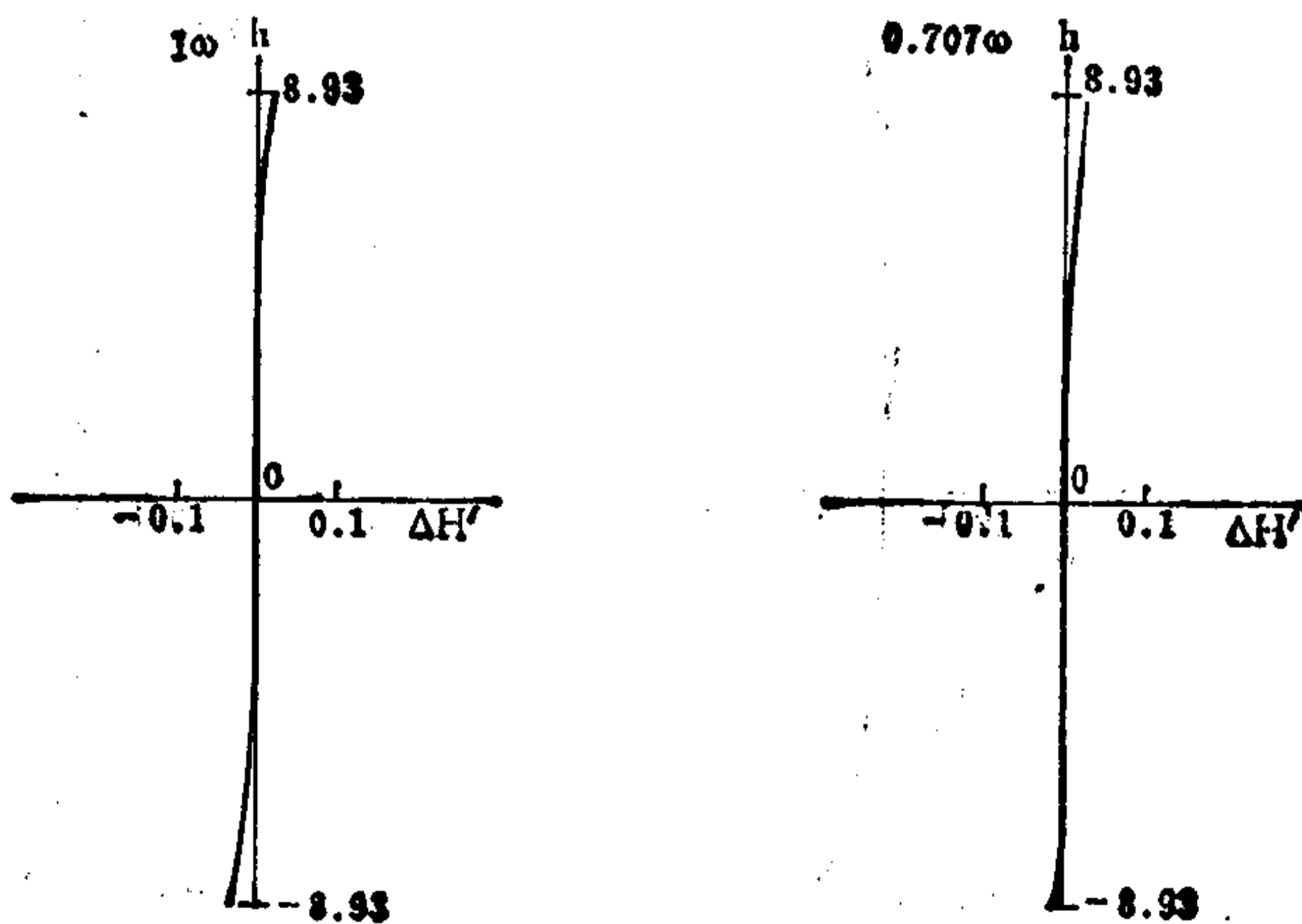
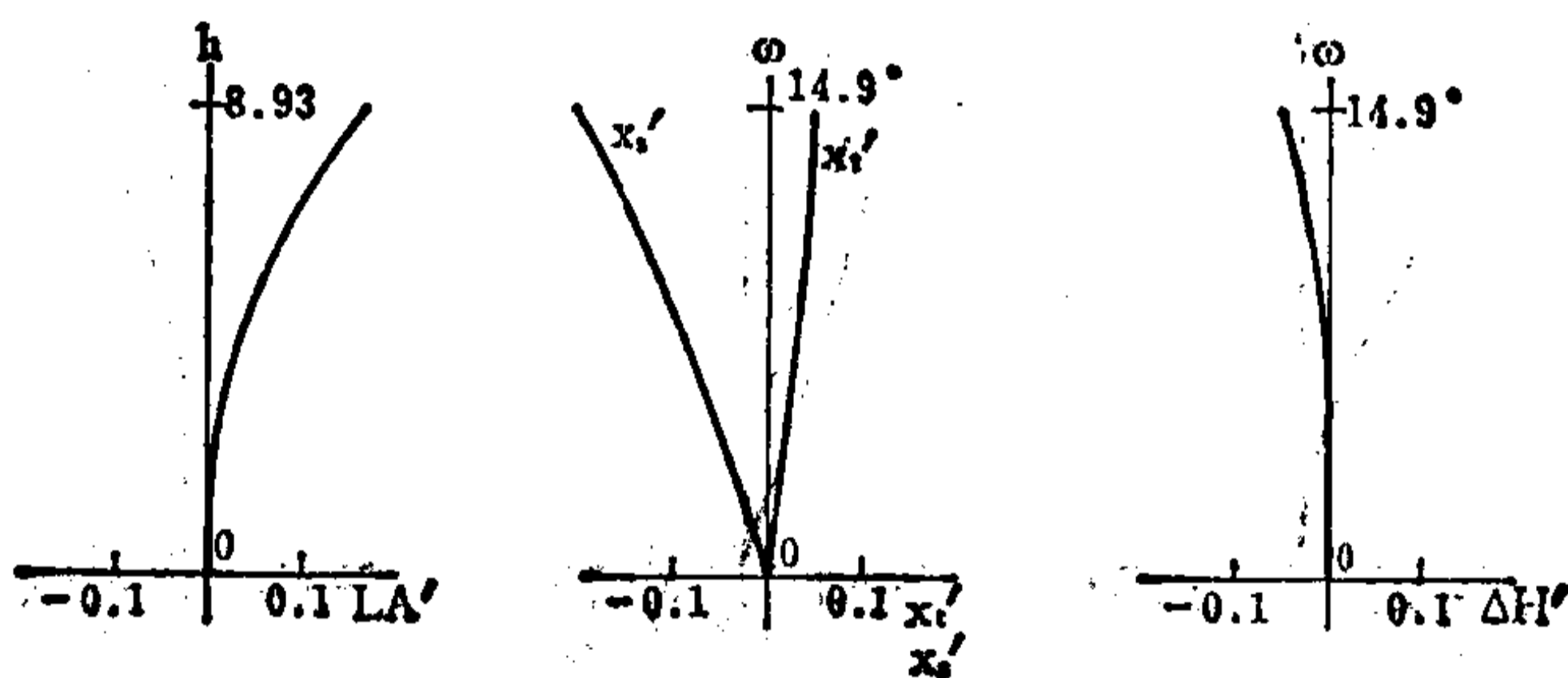

编号: 05-04-090

四组元高斯型摄影物镜

E.F.L.=99.3 B.F.L.=52.2 FNo. =5.56 F.A. = ±14.9°**

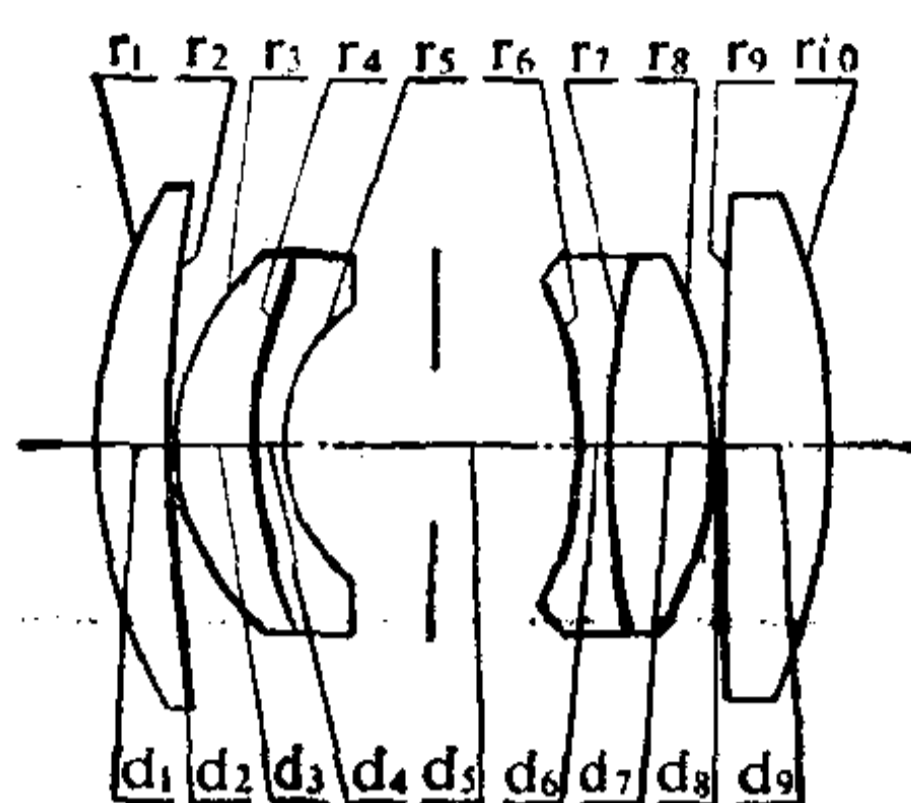

序号	r	d	n _d	v _d	序号	r	d	n _d	v _d
1	69.3	8.80	1.744	45.8	6	-46.2	3.90	1.672	32.3
2	182.0	0.47			7	110.0	13.60	1.734	51.0
3	31.8	10.40	1.697	56.2	8	-52.3	0.47		
4	56.8	3.90	1.689	30.9	9	897.0	13.50	1.734	51.0
5	21.4	37.60*			10	-84.0			

37.60* = 18.80 + 18.80

	ΣS ₁	ΣS ₂	ΣS ₃	ΣS ₄	ΣS ₅	Hf	QP(1ω)
	-0.00188	-0.00200	0.00458	-0.01432	-0.01876	26.4	-0.46%
h 或 ω%	LA'	ΔH'	x _t	x _s	x _t - x _s	K _{T1}	K _{T0.7}
100	-0.0987	-0.121	-0.273	-0.590	0.317	-0.05706	-0.02950
70	-0.0538	-0.040	-0.083	-0.305	0.222	-0.03082	-0.01632

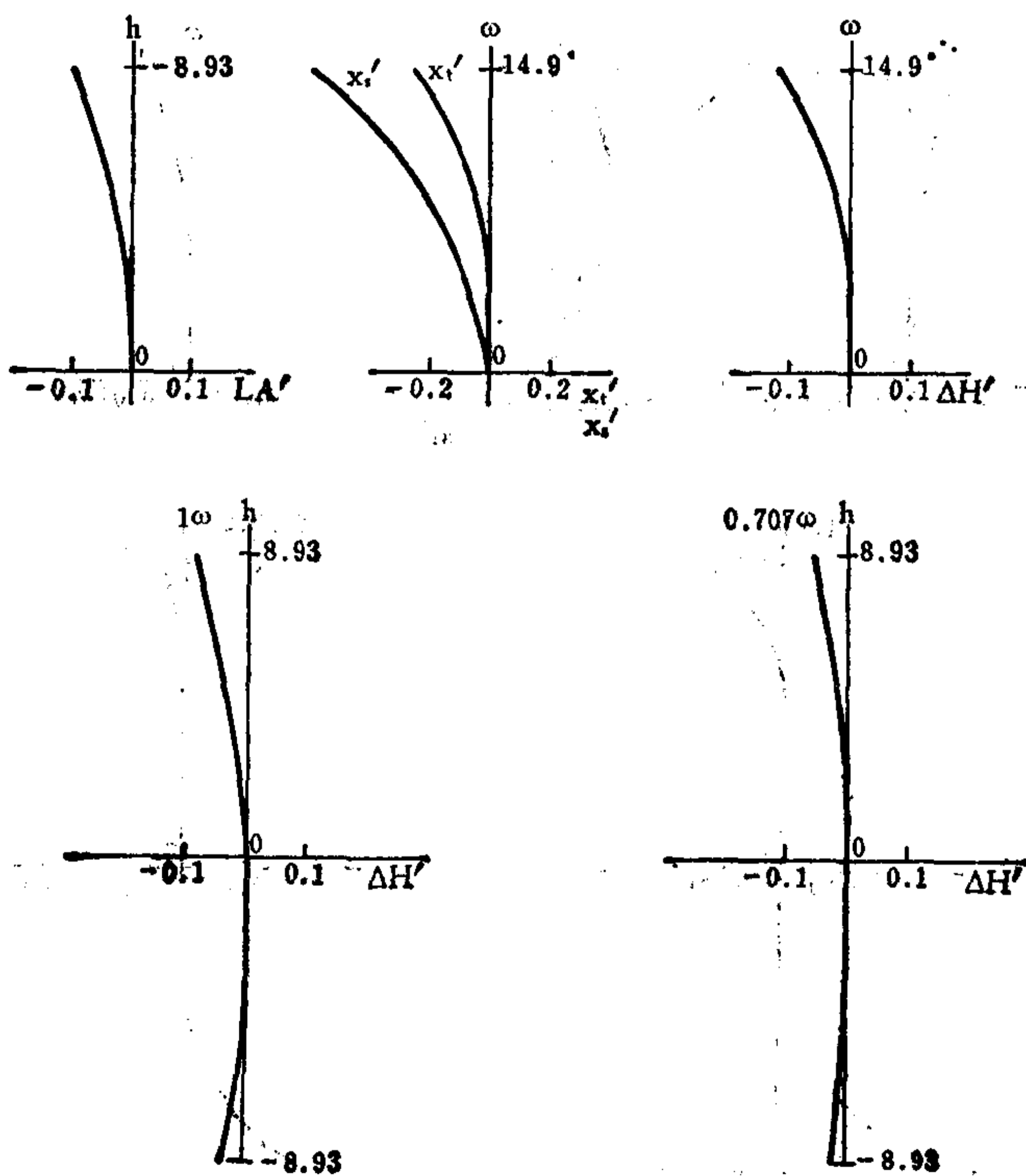

编号: 05-04-091

四片型对称重显物镜

E. F. L = 1.0063 B. F. L = 0.8663 FNo. = 4.5 F. A. = ± 30°

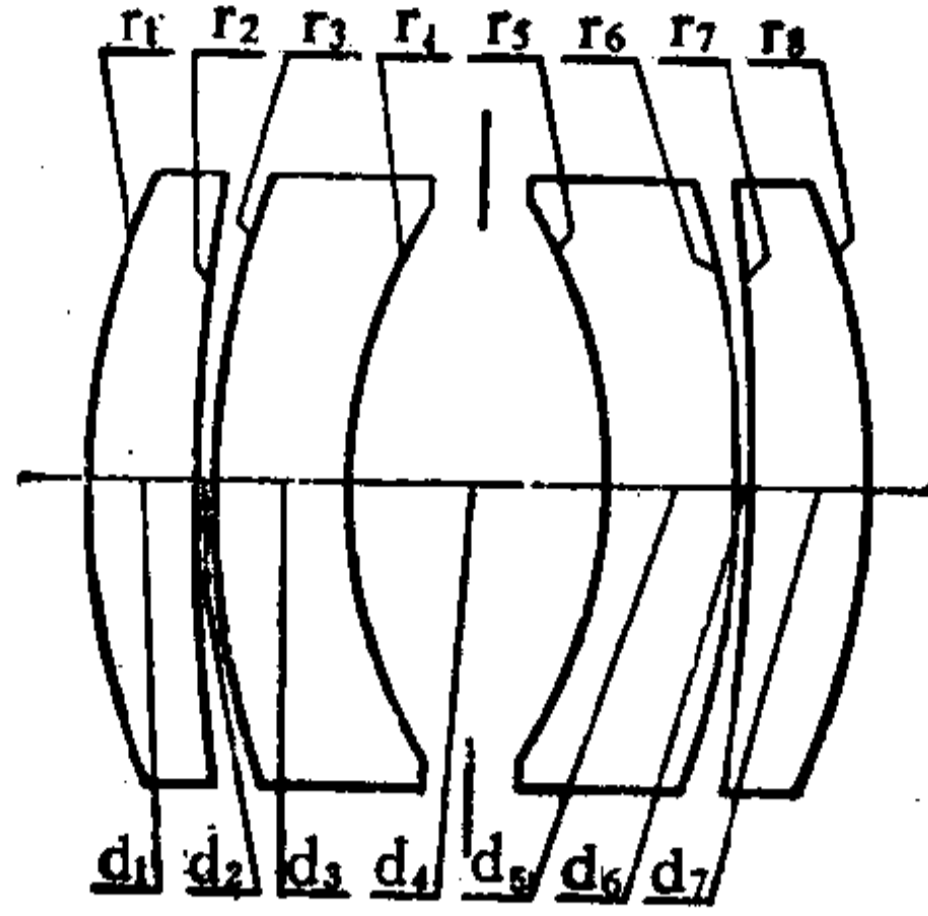

序号	r	d	n _D	v _D	序号	r	d	n _D	v _D
1	0.2696	0.042	1.588	61.2	5	-0.1870	0.049	1.617	36.6
2	1.0270	0.005			6	-0.3347	0.005		
3	0.3347	0.049	1.617	36.6	7	-1.0270	0.042	1.588	61.2
4	0.1870	0.090*			8	-0.2696			

0.090* = 0.045 + 0.045

	ΣS ₁	ΣS ₂	ΣS ₃	ΣS ₄	ΣS ₅	HI	QP(1 ω)
	-0.000175	-0.000272	0.000030	-0.000692	0.000816	0.58	1.2%
h 或 ω %	LA'	ΔH'	x _t	x _s	x _t ' - x _s '	K _{T1}	K _{T0.7}
100	-0.00686	0.00683	-0.0324	-0.0065	-0.0259	-0.01045	-0.00294
70	-0.00346	0.00183	-0.0144	-0.0102	-0.0042	-0.00864	-0.00248

注: 以上象差值是按 l = -∞ 计算的。

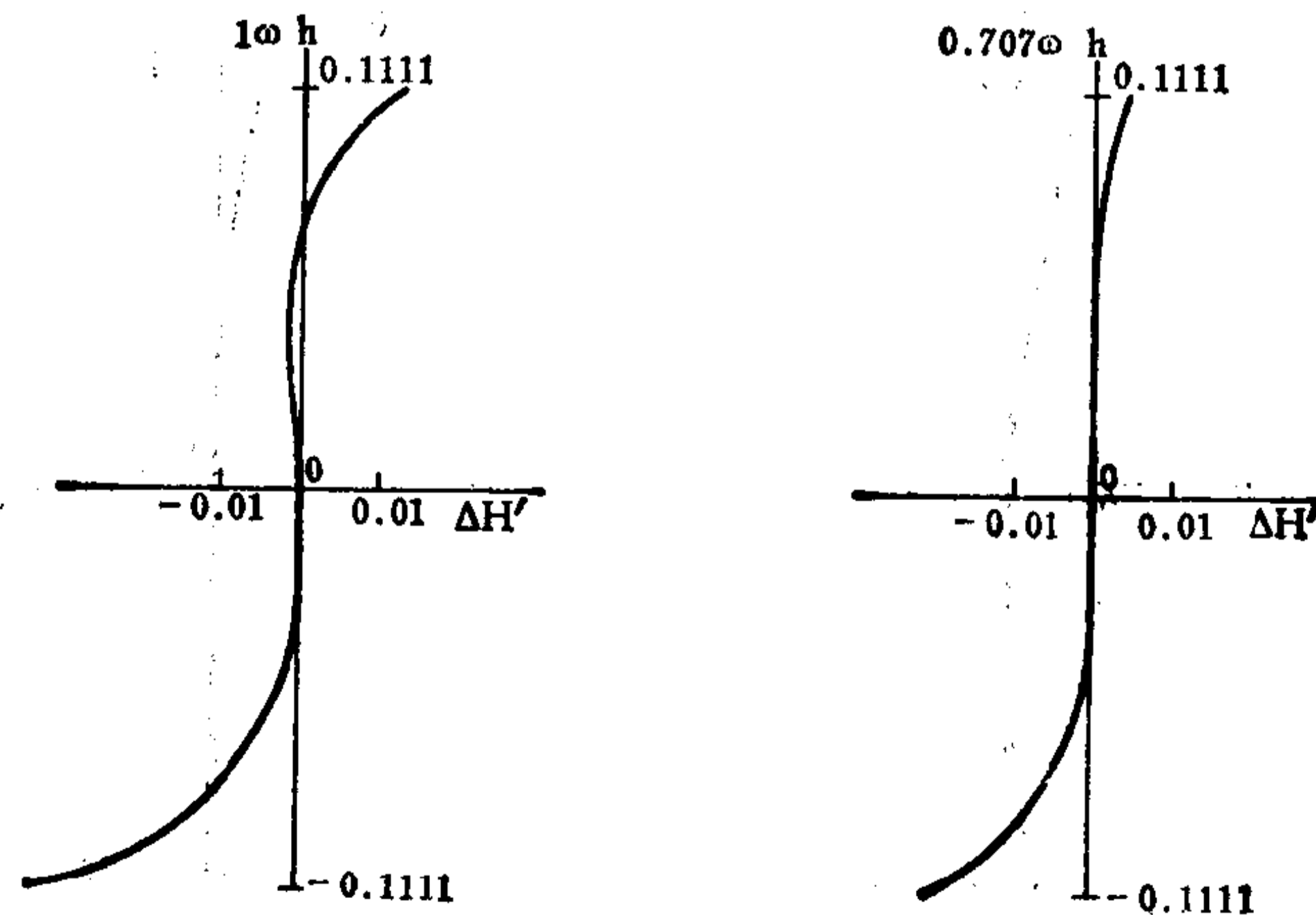
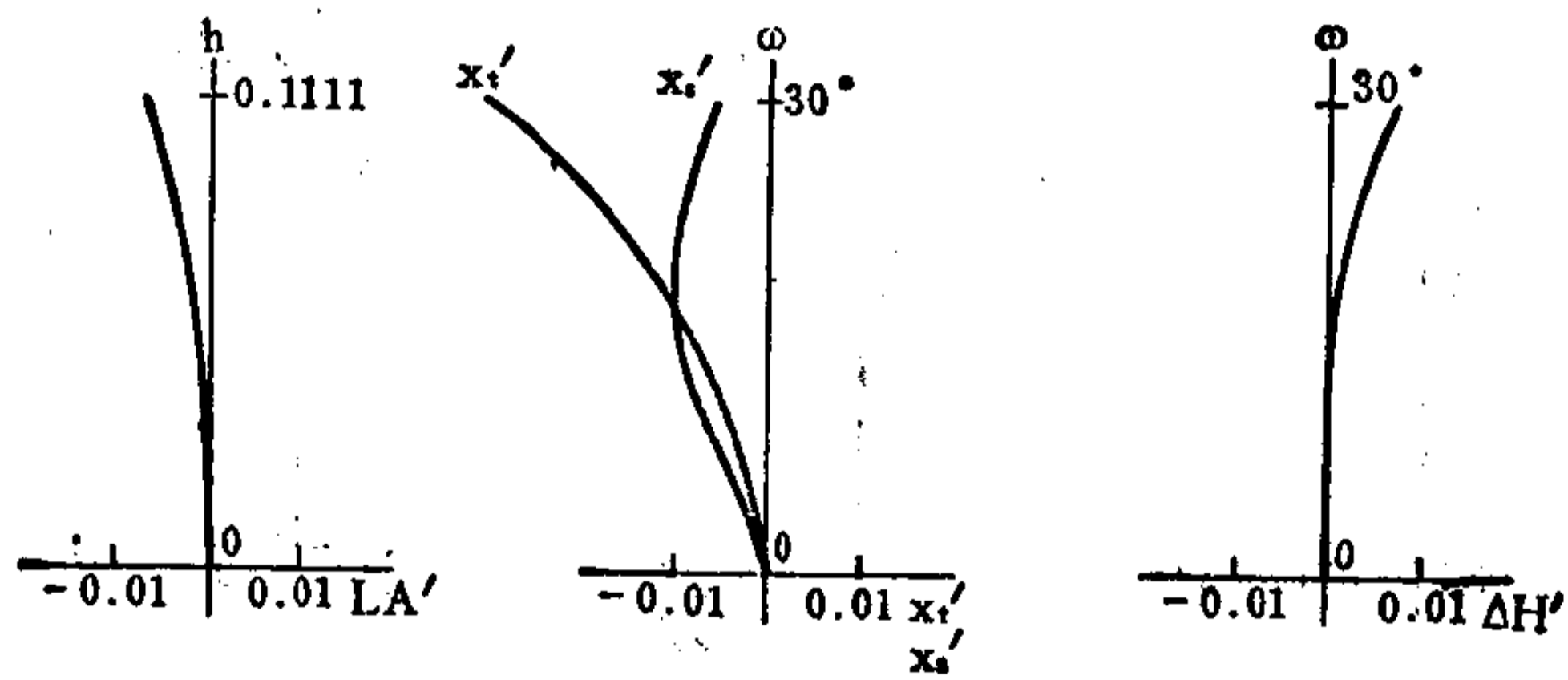

编号: 05-04-092

由两组相对复消色差透镜组成的远摄光学系统

E. F. L = 510.2 B. F. L = 126.16 FNo. = 5.6 F. A. = $\pm 2^{\circ}$ ** $L'_{p1} = 0$

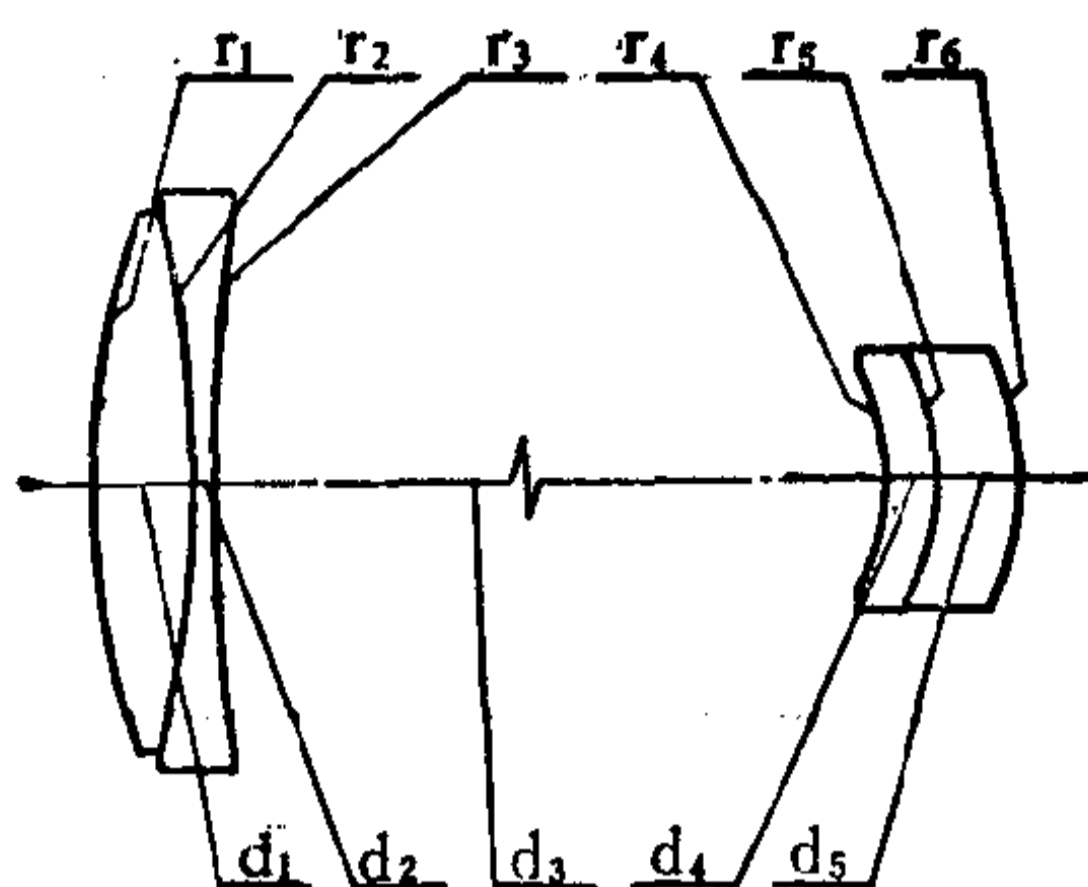

序号	r	d	n_D	ν_D	序号	r	d	n_D	ν_D
1	177.010	20.5	1.620	60.3	4	-51.523	10.6	1.611	57.2
2	-232.900	5.0	1.720	36.2	5	-56.494	17.9	1.649	33.8
3	1180.300	281.1			6	-65.464			

	ΣS_1	ΣS_2	ΣS_3	ΣS_4	ΣS_5	HI	QP(1 ω)
	-0.01070	-0.00015	0.00010	-0.00013	-0.00054	17.8	-0.02%
h 或 ω %	LA'	$\Delta H'$	x'_i	x'_s	$x'_i - x'_s$	K'_{T1}	$K'_{T0.7}$
100	-0.0751	-0.0035	0.0016	-0.0008	0.0024	0.01953	0.00566
70	-0.1985	-0.0011	0.0035	-0.0005	0.0040	0.01054	0.00259

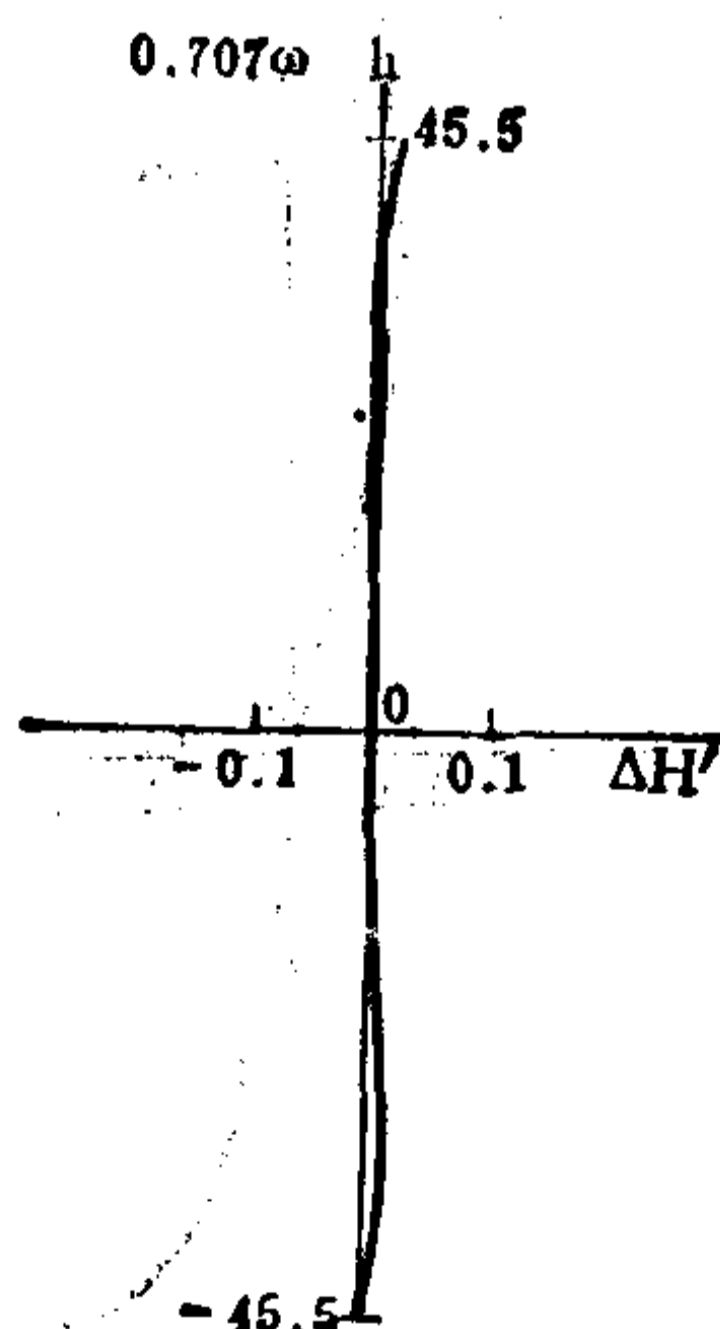
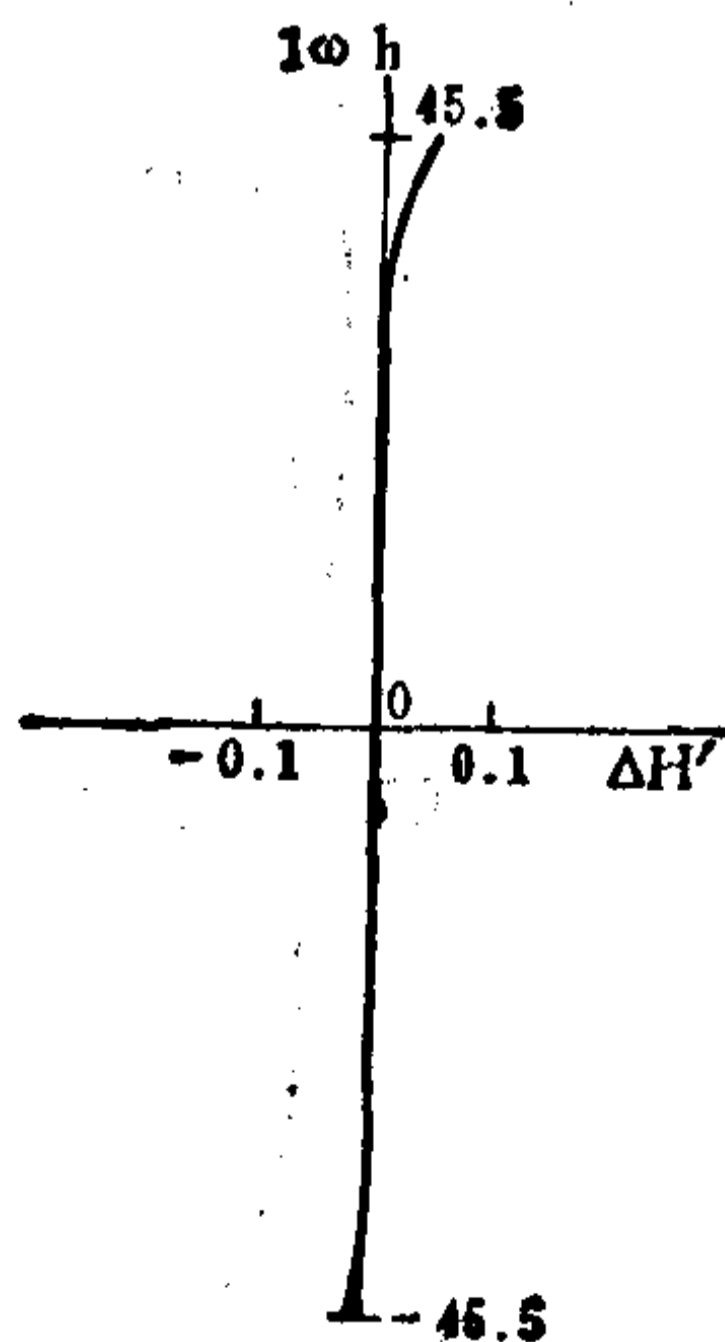
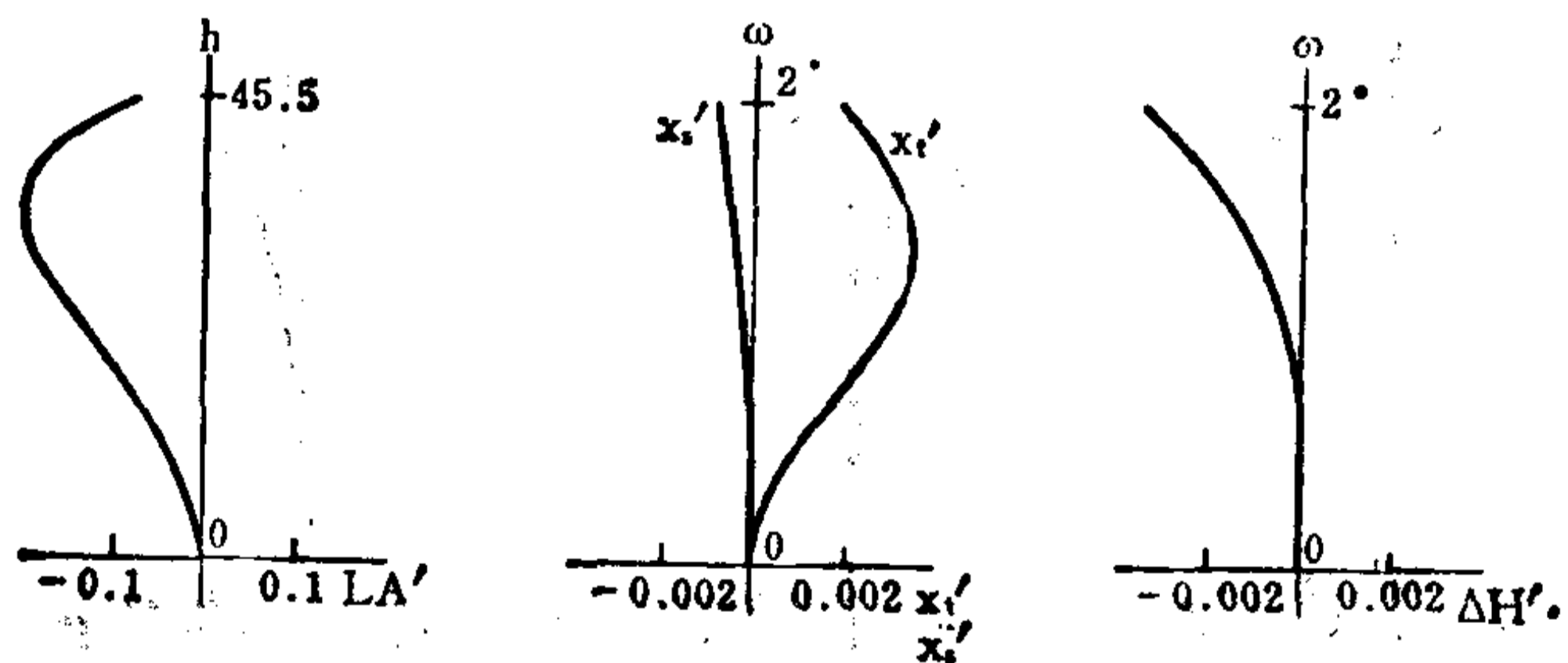

编号: 05-04-093

三片型望远物镜

E. F. L = 99.999

B. F. L = 12.606

FNo. = 3

F. A. = $\pm 3''$ **

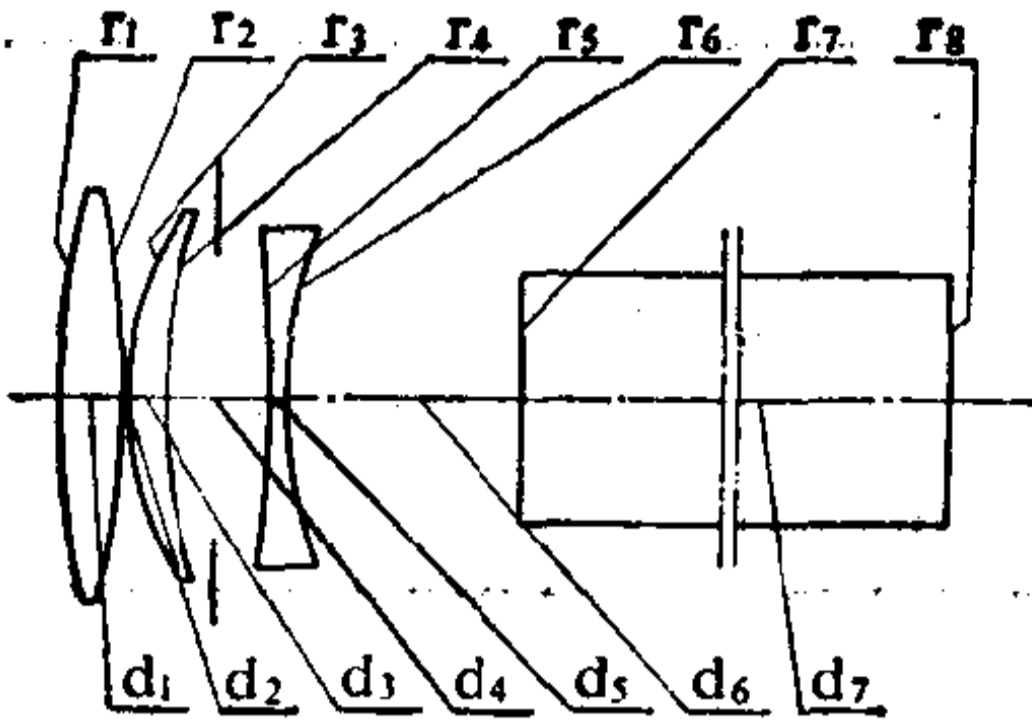

序号	r	d	n_d	v_d	序号	r	d	n_d	v_d
1	58.333	5.333	1.48631	81.87	5	-173.330	1.867	1.67270	32.23
2	-80.000	0.667			6	38.148	20.000		
3	28.000	3.667	1.51730	69.62	7	∞	53.000	1.62000	36.34
4	58.333	8.533*			8	∞			

$8.533^* = 4.000 + 4.533$

	ΣS_1	ΣS_2	ΣS_3	ΣS_4	ΣS_5	HI	QP(1 ω)
	0.01049	-0.00952	-0.01050	-0.00237	0.00255	5.2	0.15%
h 或 ω %	LA'	$\Delta H'$	x'_t	x'_s	$x'_t - x'_s$	K'_{T1}	$K_{T0.7}$
100	-0.0493	0.0077	-0.610	-0.232	-0.378	0.08211	-0.00744
70	0.0752	0.0027	-0.305	-0.116	-0.189	0.05493	-0.00636

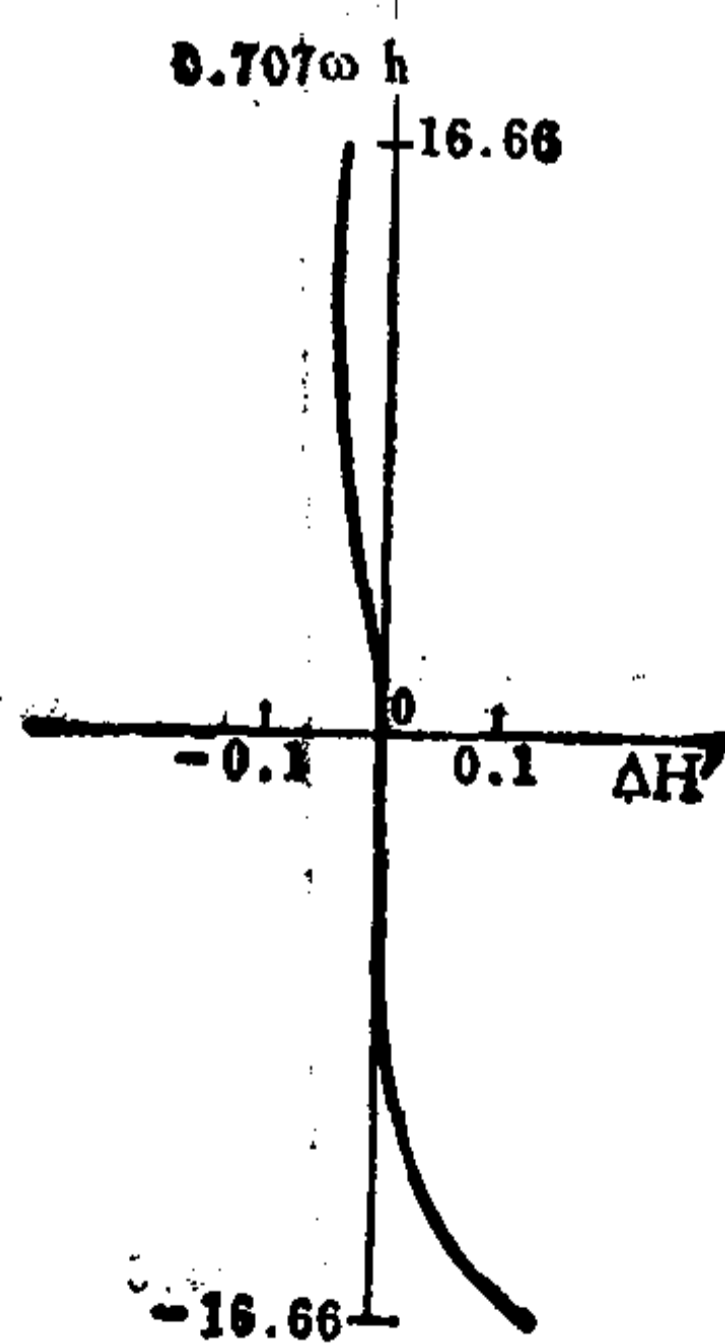
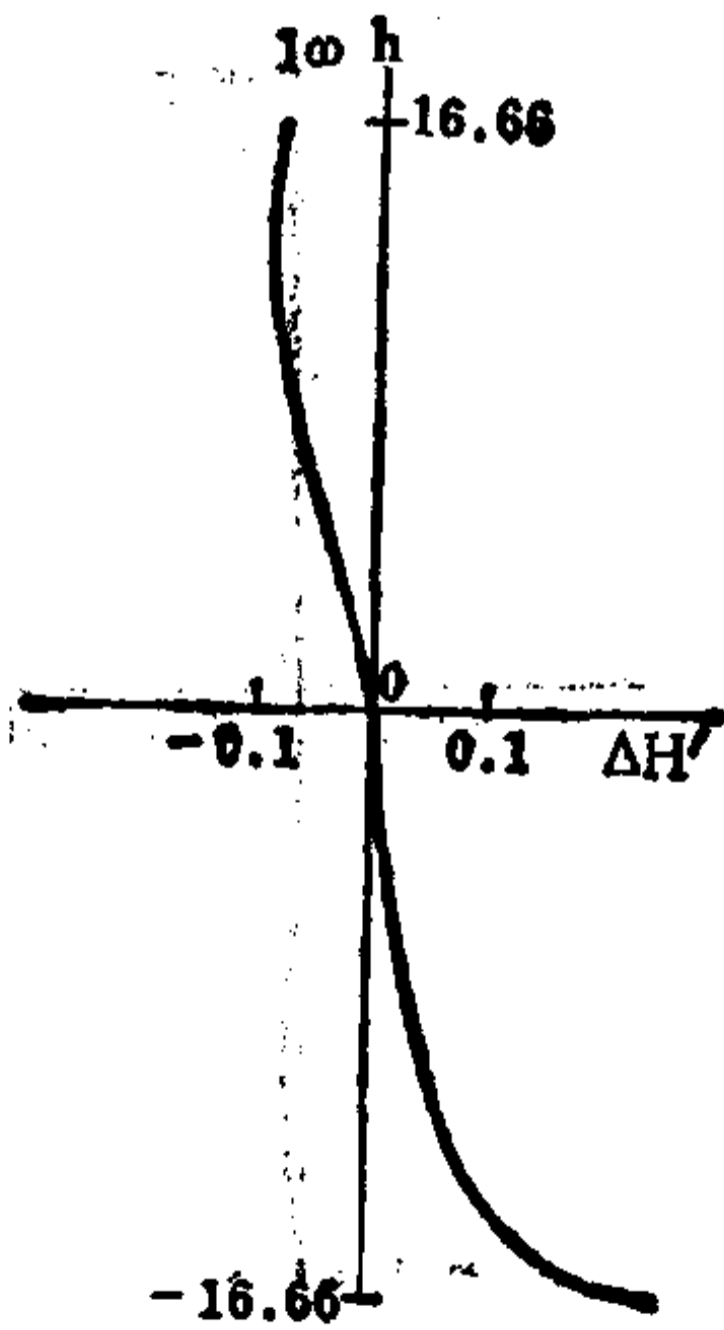
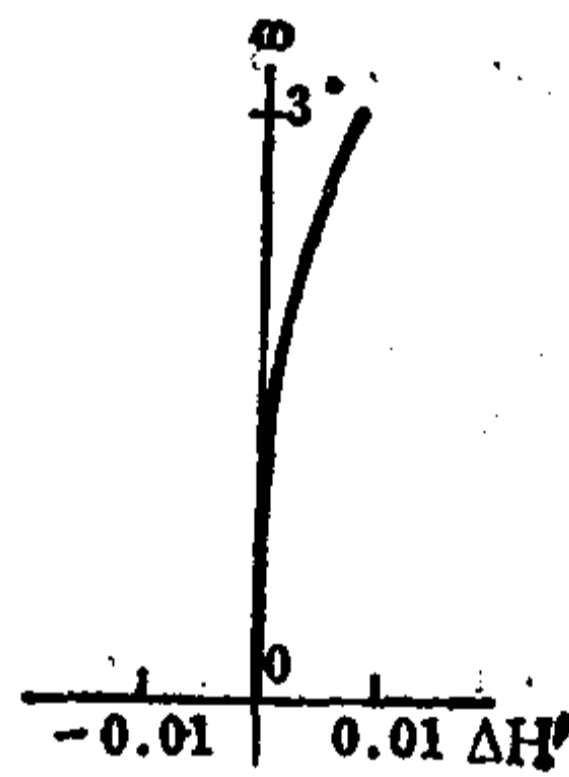
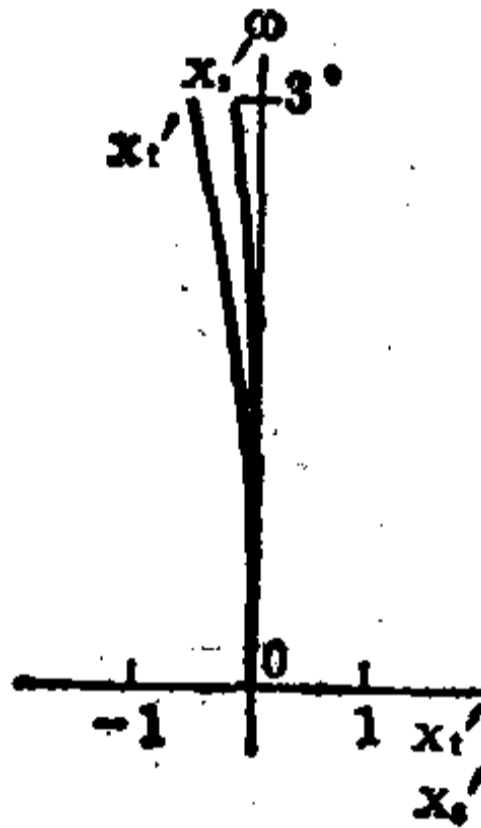
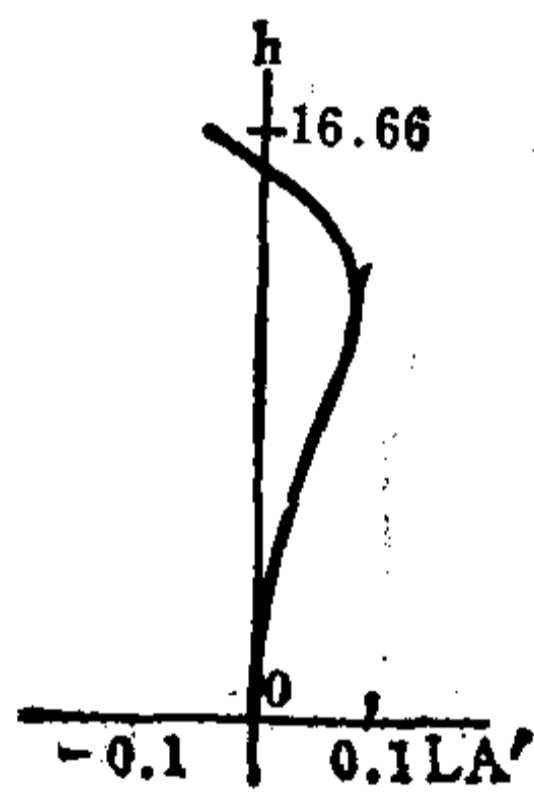

编号: 05-04-094

三片型望远物镜

E. F. L = 99.999 B. F. L = 15.159 FNo. = 2.54 F. A. = $\pm 3^{\circ}$ **

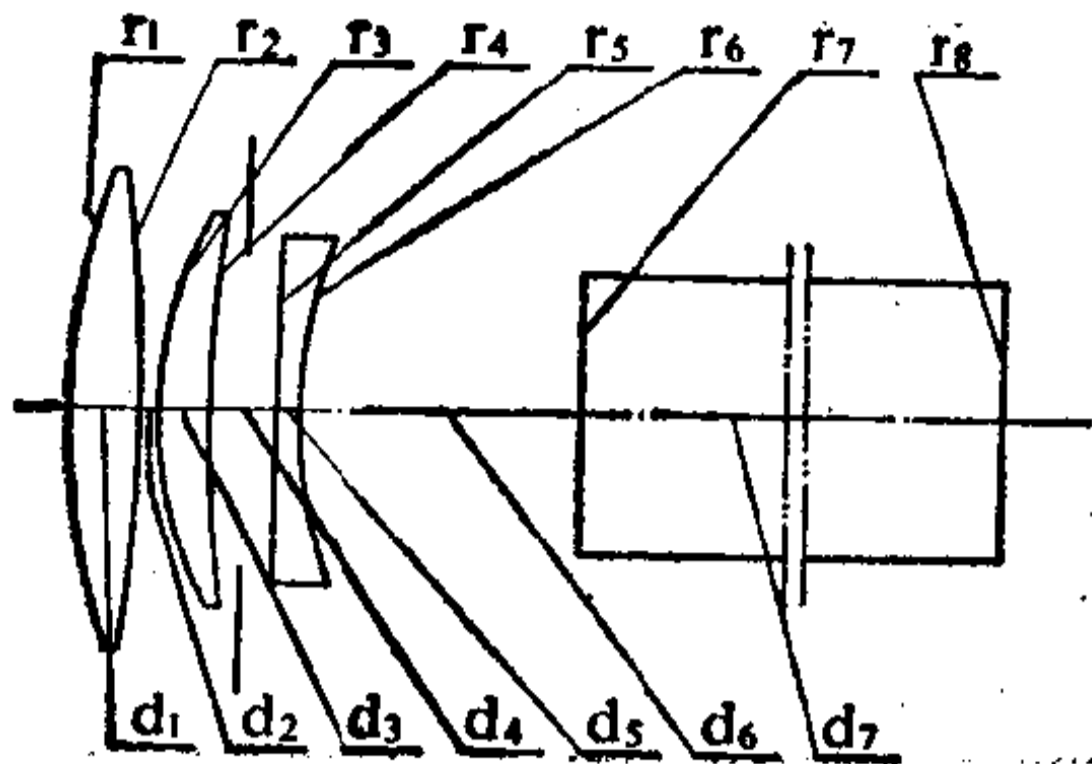

序号	r	d	nd	vd	序号	r	d	nd	vd
1	63.715	5.900	1.5582	67.75	5	∞	1.966	1.7283	28.34
2	-157.320	1.966			6	40.693	23.598		
3	36.184	3.933	1.5687	63.12	7	∞	53.000	1.6200	36.34
4	117.990	5.900*			8	∞			

5.900* = 3.000 + 2.900

	ΣS_1	ΣS_2	ΣS_3	ΣS_4	ΣS_5	HI	QP(1 ω)
	0.00541	-0.00654	-0.01165	-0.00470	0.00210	5.2	0.1%
h 或 ω %	LA'	$\Delta H'$	x'_t	x'_s	$x'_t - x'_s$	K'_{T1}	$K'_{T0.7}$
100	0.0043	0.0054	-0.511	-0.211	-0.300	0.02543	-0.00802
70	0.0309	0.0019	-0.256	-0.106	-0.150	0.01648	-0.00627

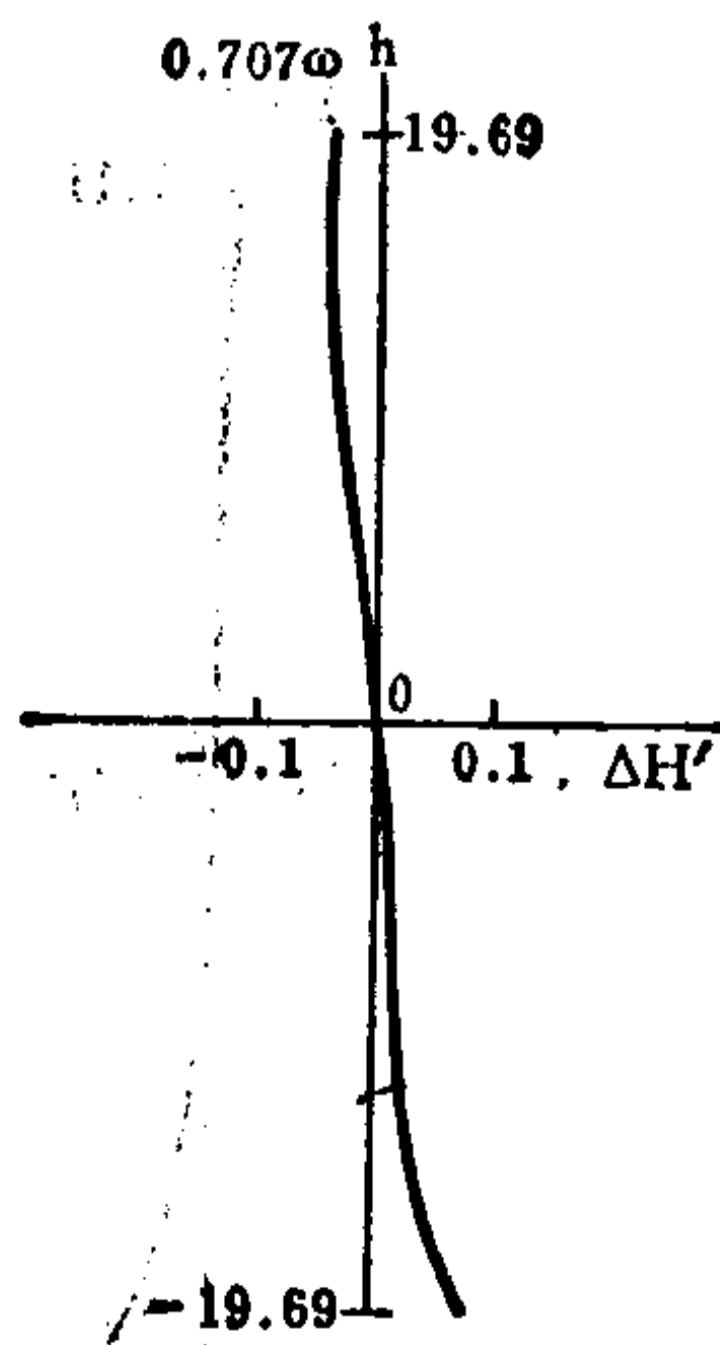
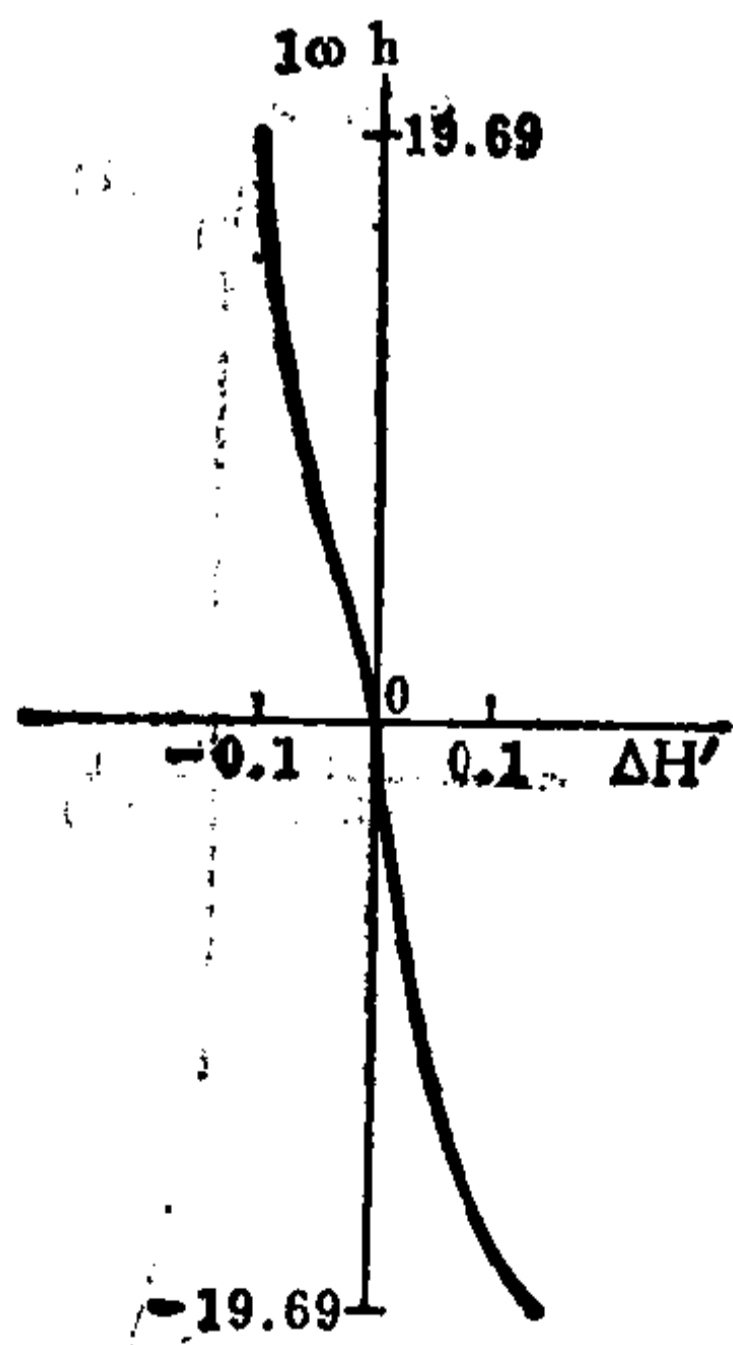
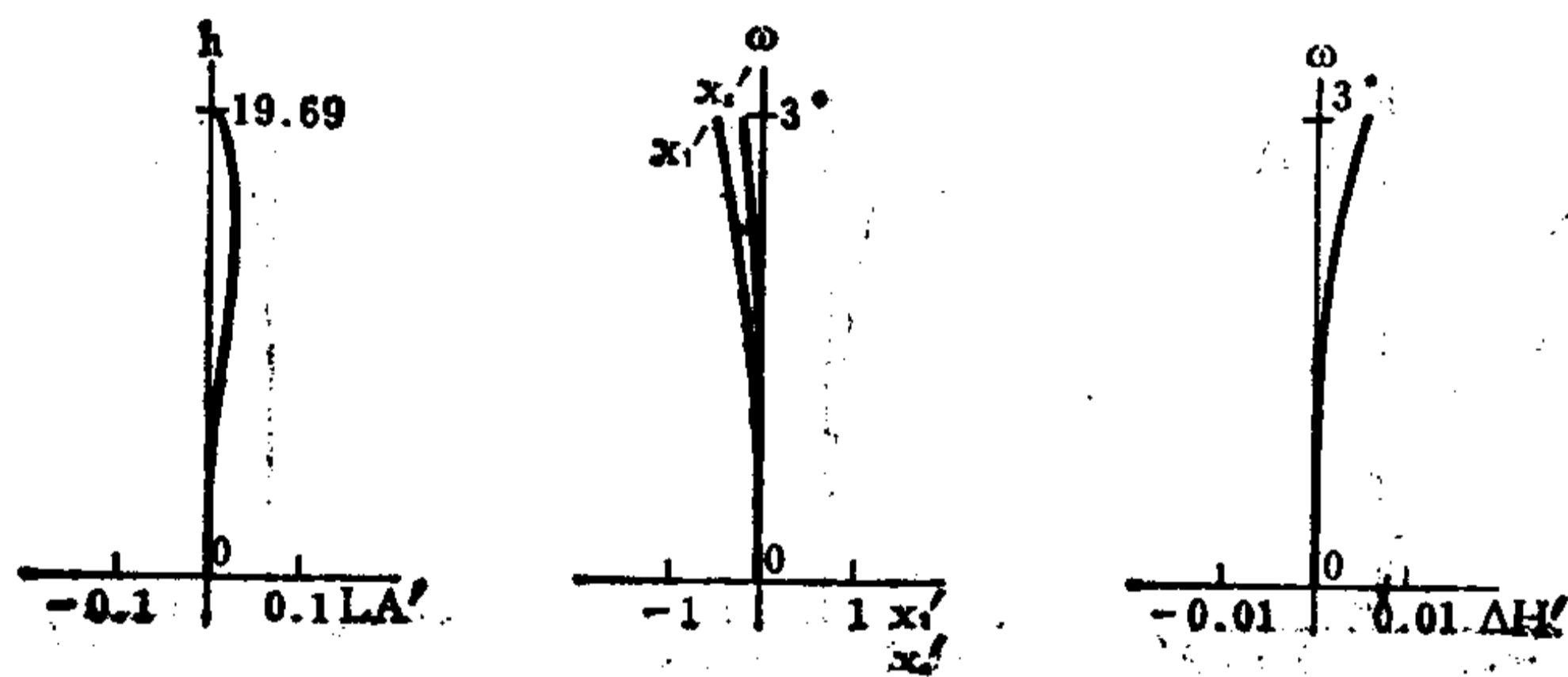

编号: 05-04-095

小倍率望远镜式远摄透镜系统

E.F.L = 97.79 B.F.L = 23.95 FNo. = 4.4 F.A. = ± 2.98°

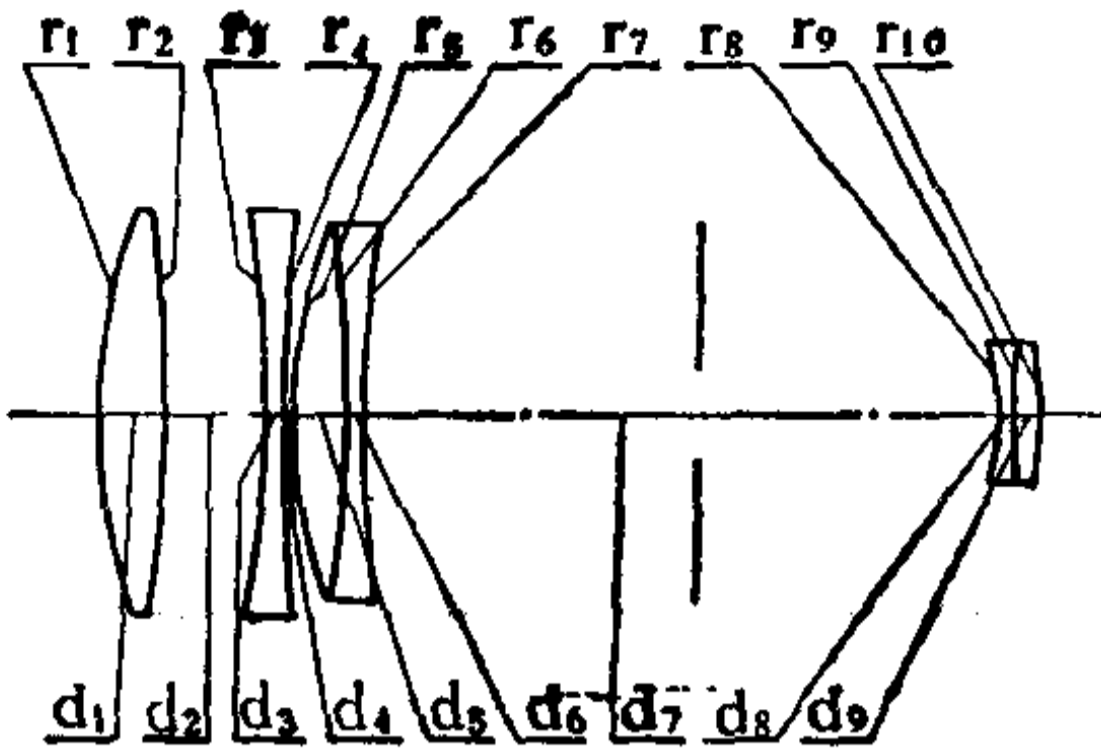

序号	r	d	n	v	序号	r	d	n	v
1	32.2150	3.50	1.48749	70.2	6	- 54.0170	1.00	1.61340	43.8
2	- 79.5966	5.50			7	67.3400	33.75*		
3	- 57.7059	1.00	1.80610	40.8	8	- 12.9220	0.75	1.71300	54.0
4	153.2590	0.20			9	42.8340	1.25	1.74950	35.2
5	28.4860	3.00	1.61800	63.4	10	- 23.7076			

33.75* = 18.00 + 15.75

	ΣS_1	ΣS_2	ΣS_3	ΣS_4	ΣS_5	HI	QP(1 ω)
	- 0.00866	0.00141	- 0.00071	0.00080	0.00567	5.09	0.5%
h 或 ω %	LA'	$\Delta H'$	x'_i	x'_s	$x'_i - x'_s$	K'_{T1}	$K'_{T0.7}$
100	- 0.2422	0.0253	- 0.0600	0.0015	- 0.0615	0.04722	0.01545
70	- 0.1442	0.0028	- 0.0279	0.0012	- 0.0291	0.02820	0.00959

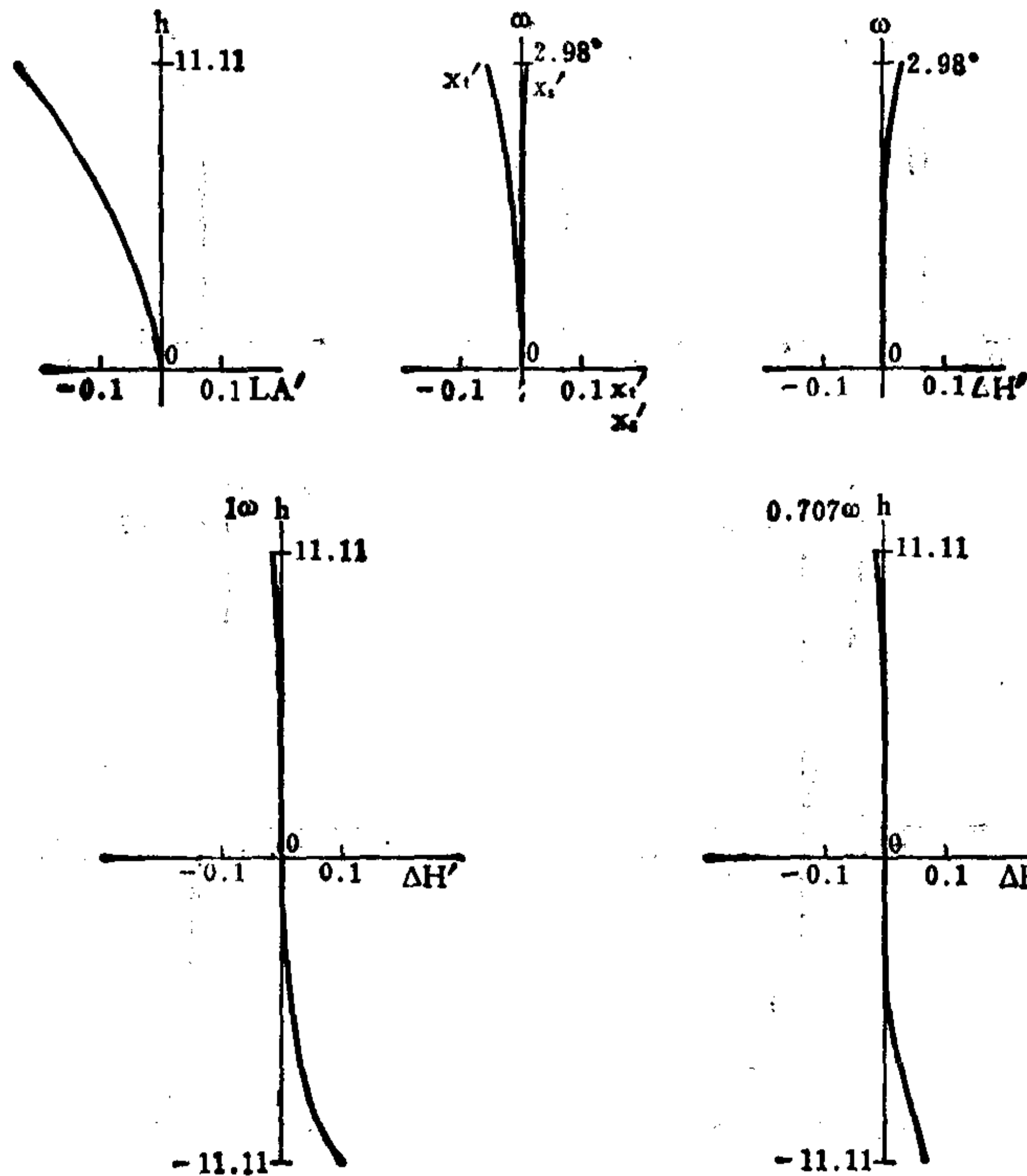

编号: 05-04-096

对 称 投 影 物 镜

E. F. L = 312 B. F. L = 252.9 FNo. = 16.06 F. A. = $\pm 10^\circ$ **

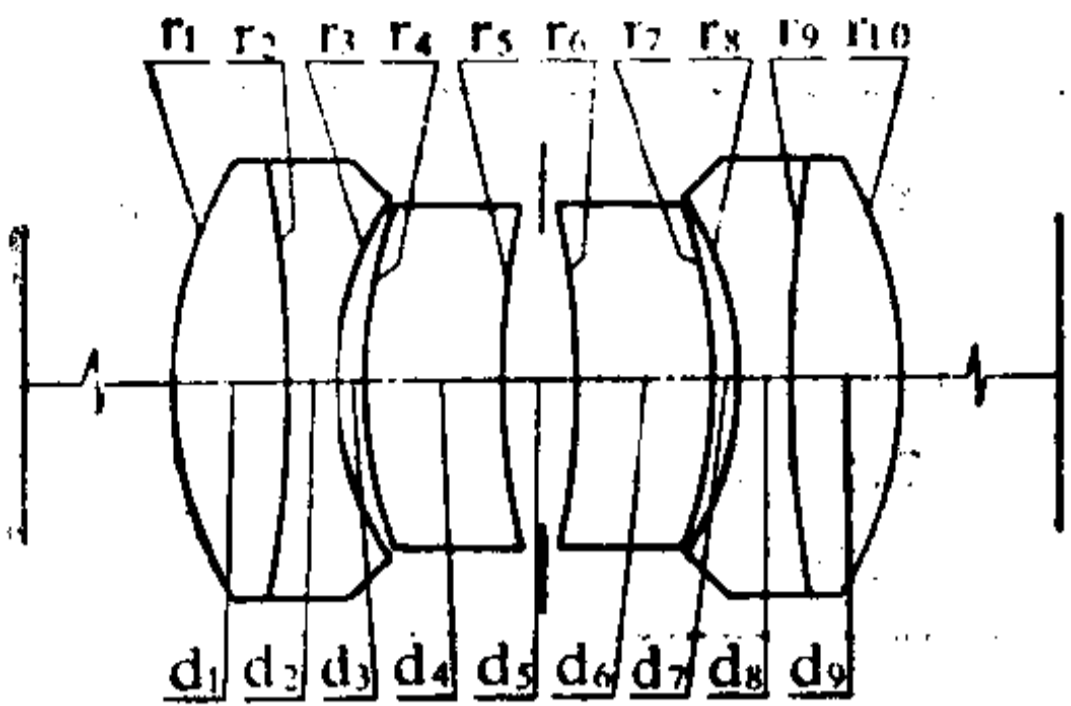

序号	r	d	n _D	v _D	序号	r	d	n _D	v _D
1	74.473	18.8	1.611	57.2	6	-136.770	23.6	1.566	53.8
2	-220.800	9.1	1.559	45.5	7	-87.902	4.3		
3	55.463	4.3			8	-55.463	9.1	1.559	45.5
4	87.902	23.6	1.566	53.8	9	220.800	18.8	1.611	57.2
5	-136.770	12.0*			10	74.473			

12.0* = 6.0 + 6.0

	ΣS_1	ΣS_2	ΣS_3	ΣS_4	ΣS_5	HI	QP(1 ω)
	0.000059	-0.000719	-0.000080	-0.001089	0.001254	55.2	0.04%
h 或 ω %	LA'	$\Delta H'$	x'_t	x'_s	$x'_t - x'_s$	K_{T1}	$K'_{T0.7}$
100	0.055	0.022	-0.628	-0.526	-0.102	-0.0353	-0.0177
70	0.021	0.007	-0.332	-0.285	-0.047	-0.0248	-0.0124

注: 1. $M = 0.5^\times \sim 1^\times \sim 1.5^\times$,
 物点 = 873.6 562.7 459.1,
 象点 = 407.2 562.7 718.1,
 2. 以上象差值是按 $l = -\infty$ 计算的。

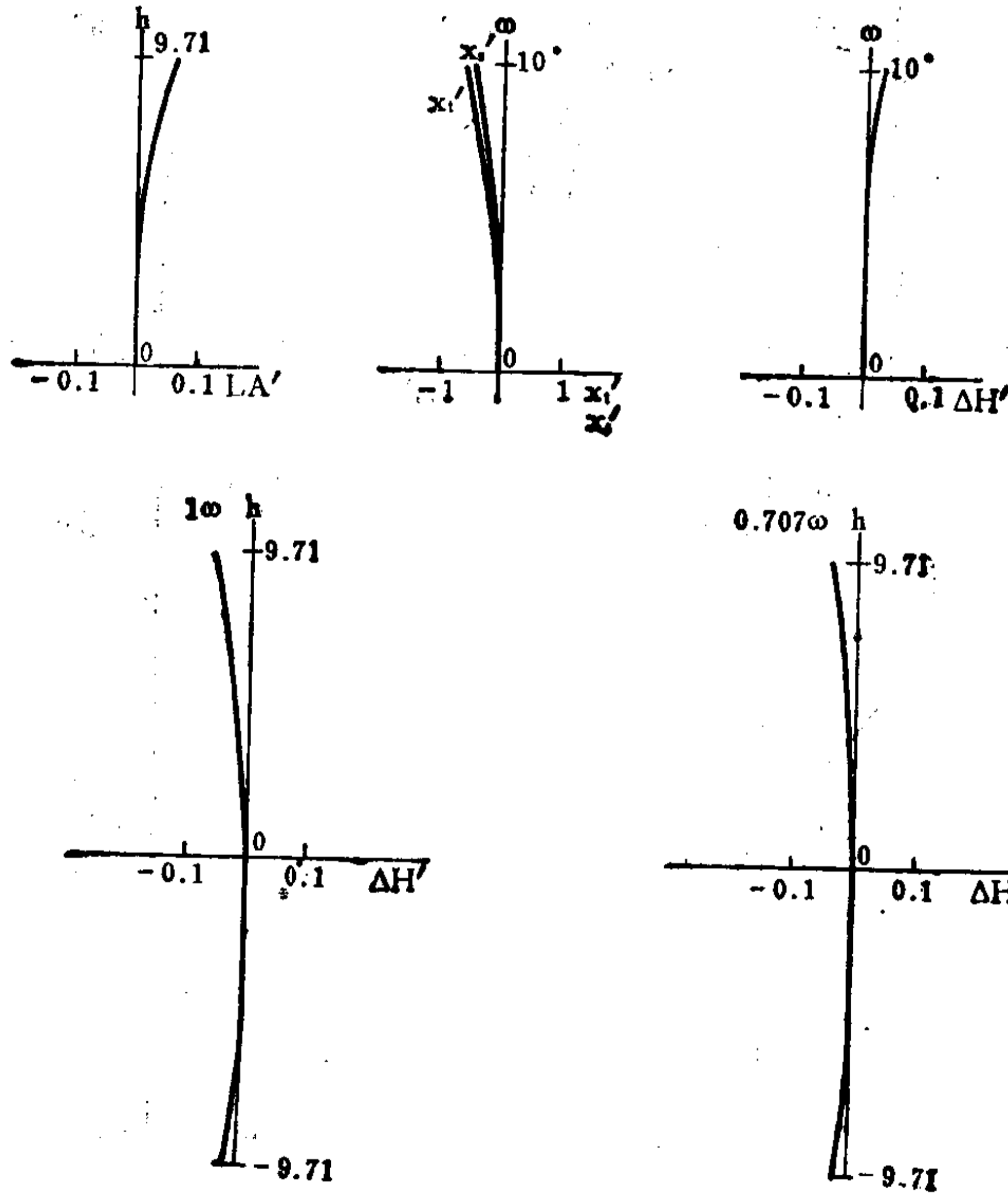

编号: 05-04-097

三片型摄影物镜

E.F.L.=100.01 B.F.L.=82.97 FNo.=2.8 F.A.=±23.5°

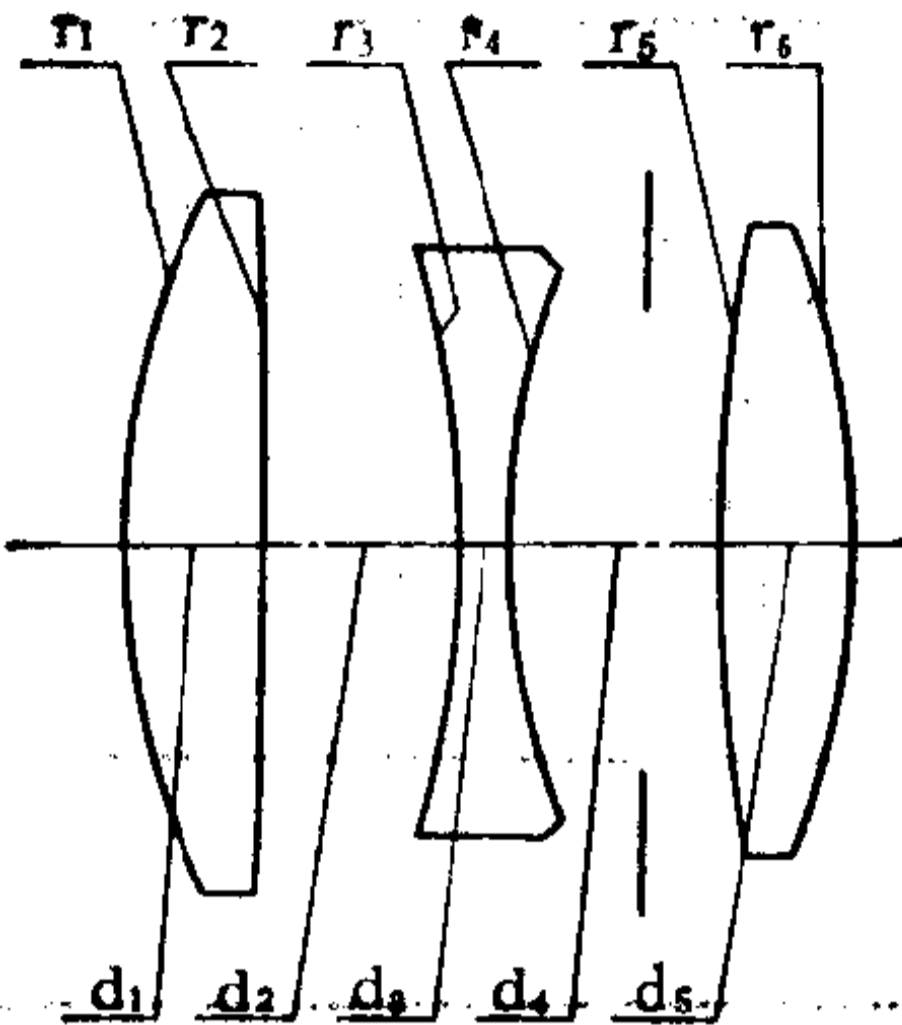

序号	r	d	n _d	v _d	序号	r	d	n _d	v _d
1	42.81	7.476	1.65844	50.84	4	41.27	11.265*		
2	-7013.04	10.241			5	167.23	6.799	1.69100	54.80
3	-60.91	2.969	1.67270	32.23	6	-47.56			

11.265* = 7.000 + 4.265

	ΣS ₁	ΣS ₂	ΣS ₃	ΣS ₄	ΣS ₅	HI	QP(1ω)
	-0.1038	0.0516	0.0417	-0.2034	-0.0737	43.5	-0.6%
h 或 ω %	LA'	ΔH'	x ₁	x ₂	x ₁ ' - x ₂ '	K _{T1}	K _{T0.7}
100	0.723	-0.281	-2.175	-0.567	-1.608	-1.3352	-0.3487
70	-0.386	-0.108	-0.307	-0.838	0.531	-0.8771	-0.1197

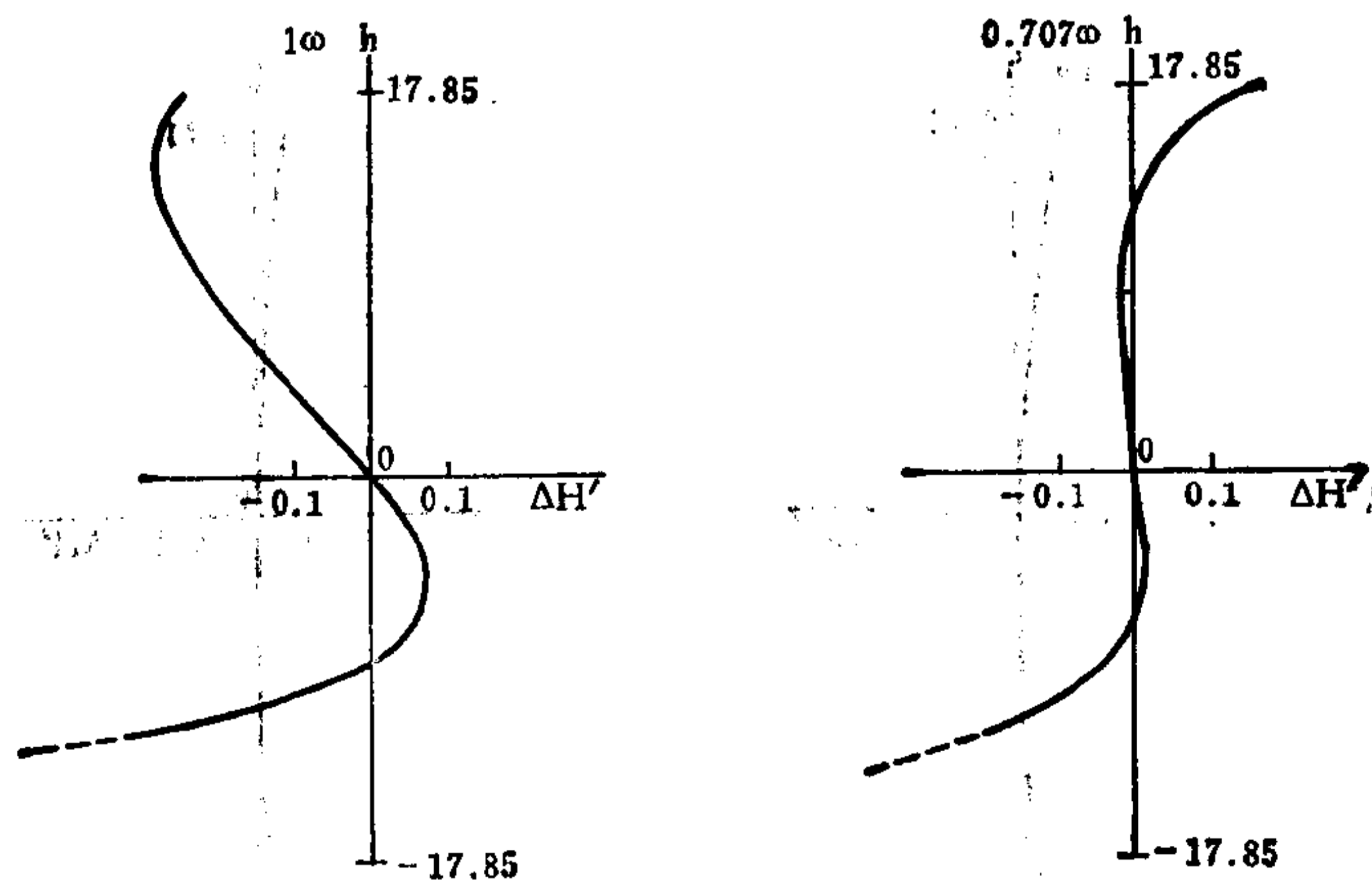
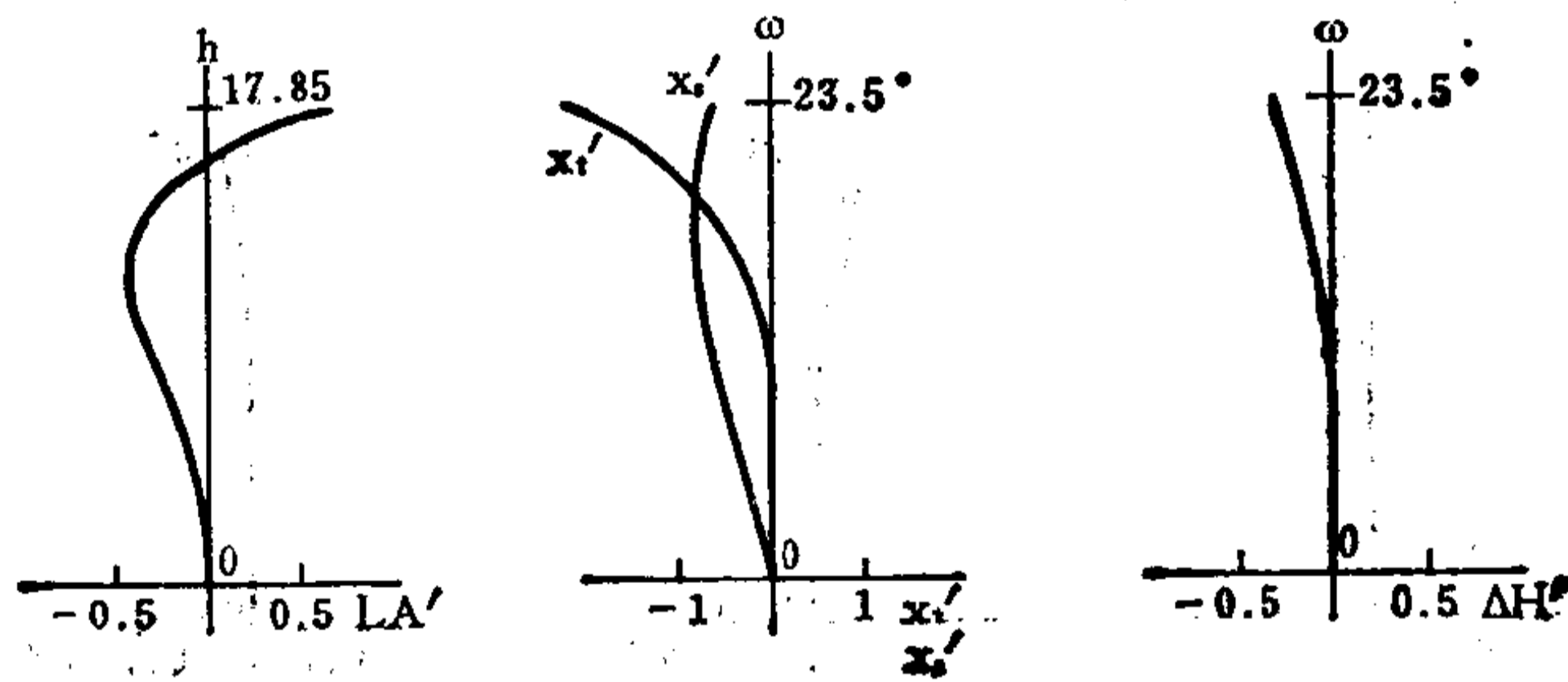

编号: 05-04-098

二级光谱较小三组元透镜系统

E. F. L = 100 B. F. L = 82.47 FNo. = 4.5 F. A. = ± 15°**

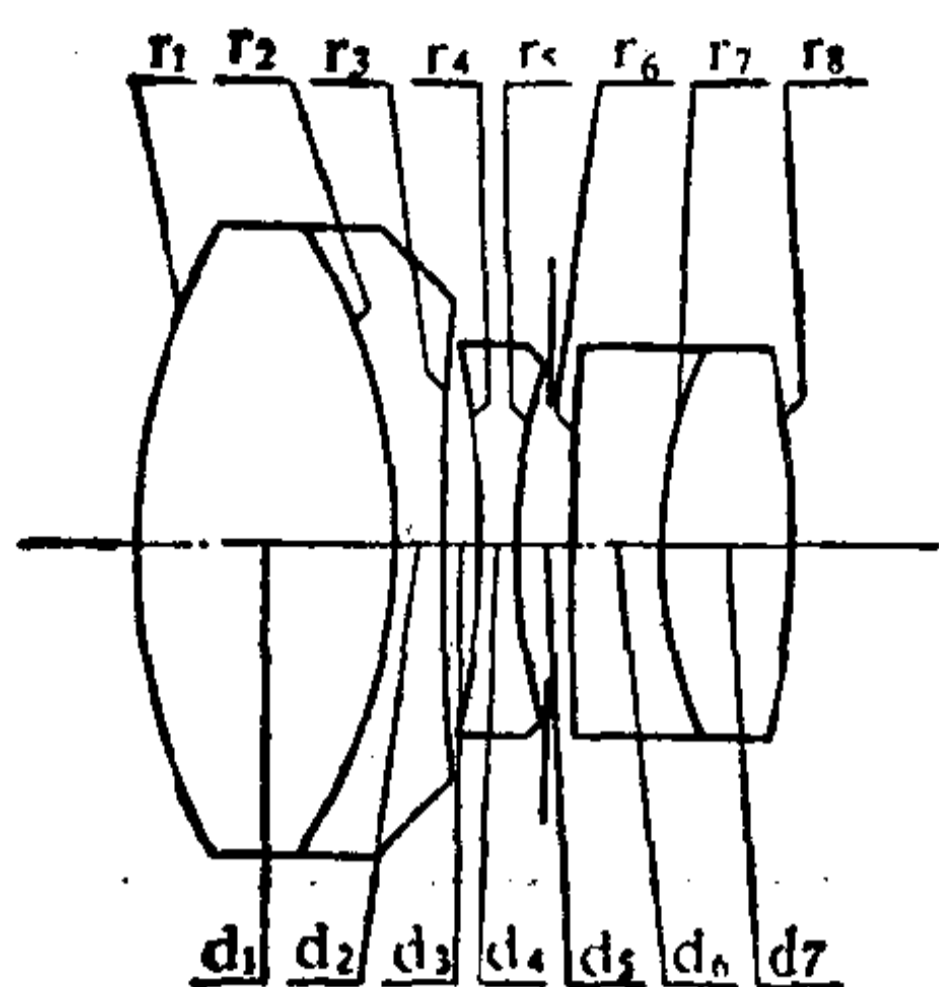

序号	r	d	n _D	v	序号	r	d	n _D	v
1	35.170	13.784	1.62005	63.5	5	33.670	3.035*		
2	-32.836	2.667	1.51700	64.5	6	314.750	4.840	1.65317	39.7
3	220.470	2.056			7	26.483	6.870	1.74500	46.4
4	-44.142	2.074	1.65317	39.7	8	-45.368			

3.035* = 1.500 + 1.535

	ΣS ₁	ΣS ₂	ΣS ₃	ΣS ₄	ΣS ₅	HI	QP(1 ω)
	- 0.01073	- 0.00103	0.00452	- 0.01487	0.00432	26.8	0.04%
h 或 ω %	LA'	ΔH'	x _t '	x _s '	x _t ' - x _s '	K _{T1}	K _{T0.7}
100	- 0.0259	0.0113	0.1034	- 0.1850	0.2884	- 0.04937	- 0.01833
70	- 0.1232	0.0056	0.0183	- 0.1564	0.1747	- 0.04135	- 0.01291

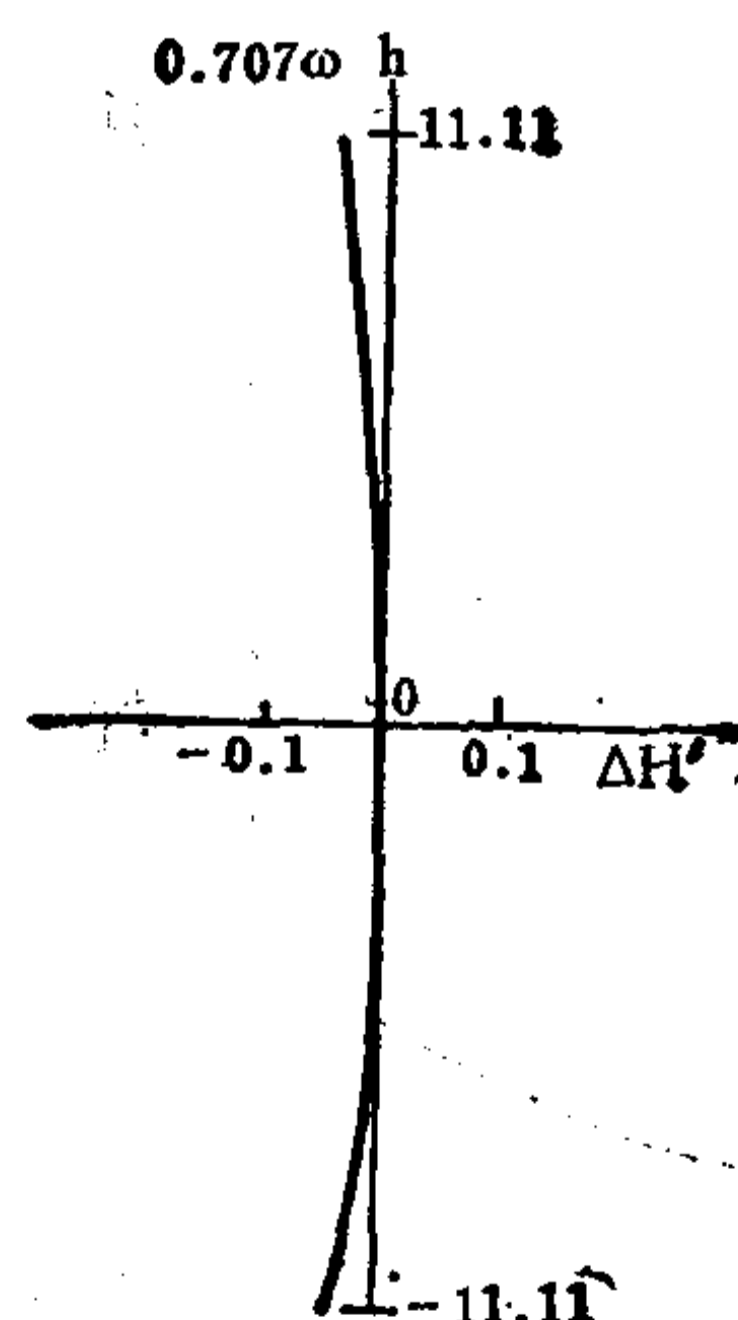
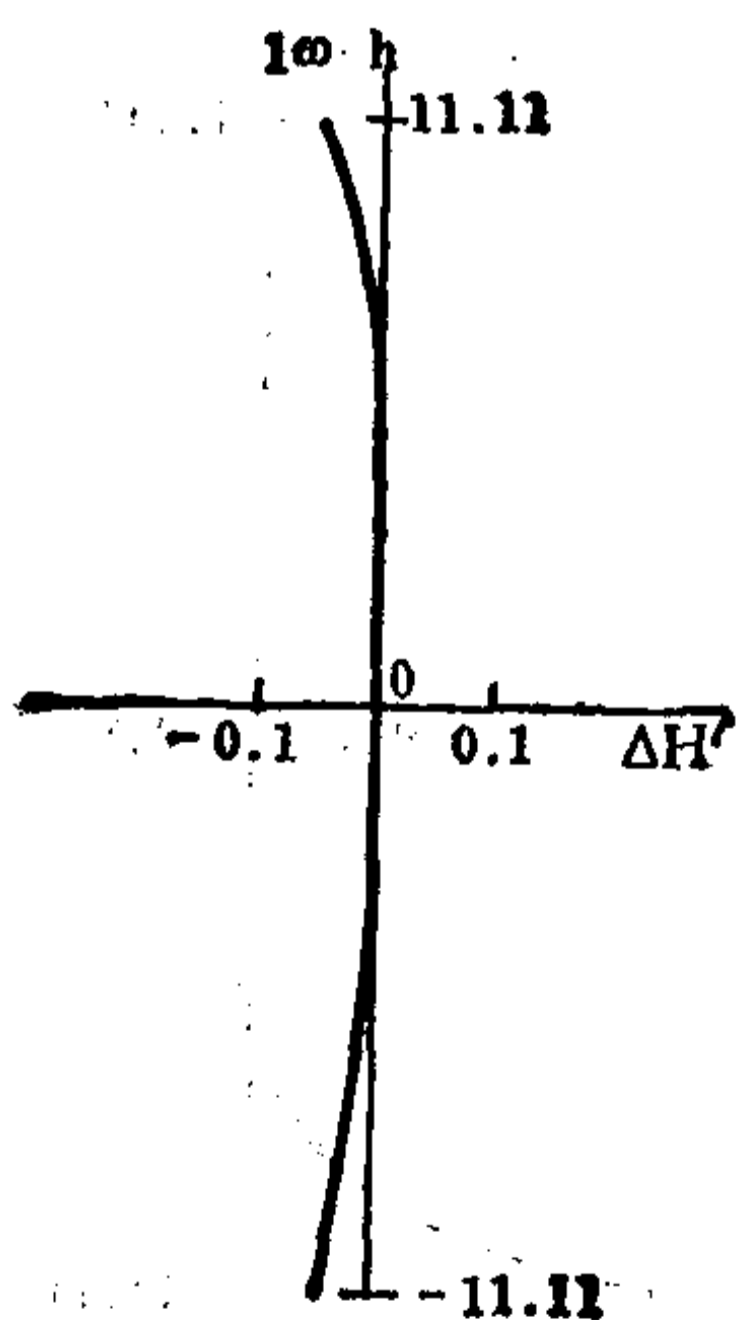
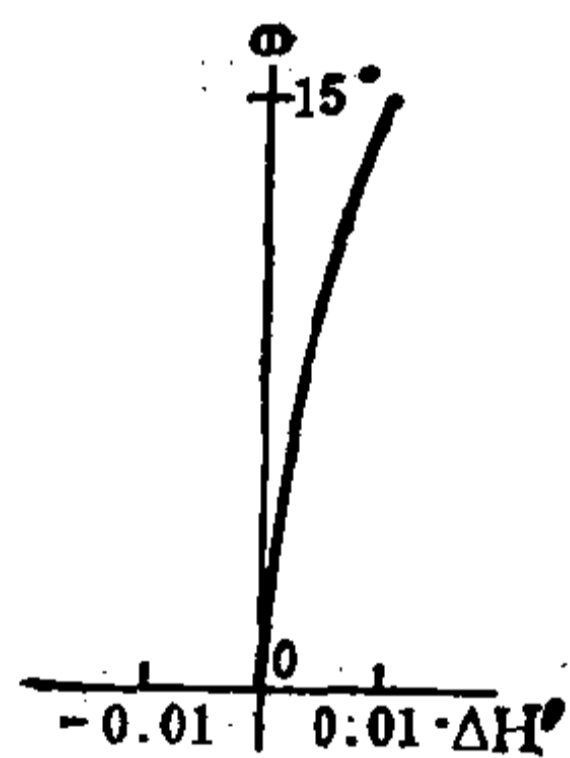
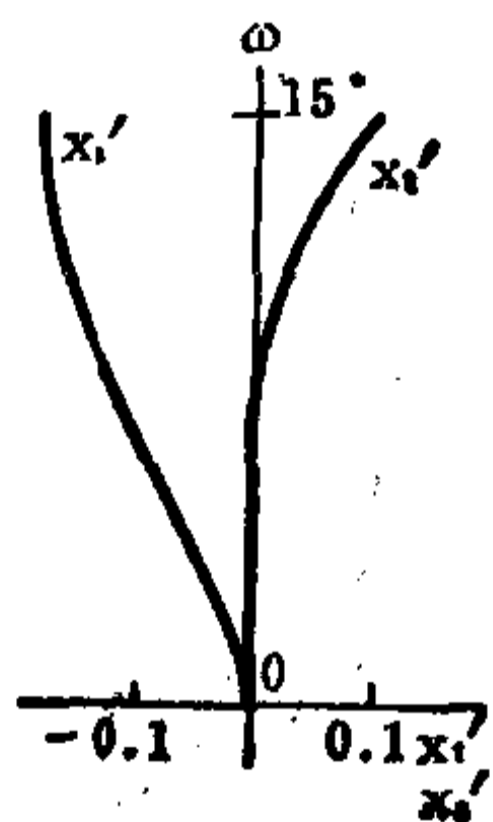
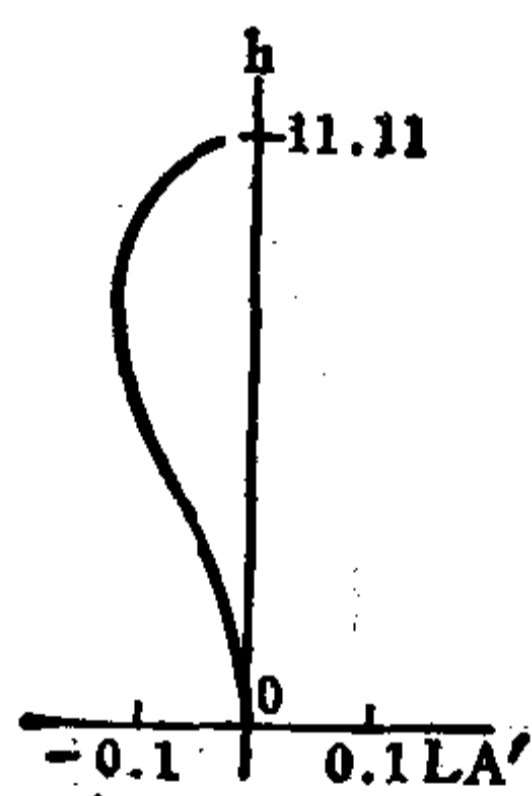

编号: 05-04-099

远 摄 物 镜

E. F. L = 100.2 B. F. L = 23.1 FNo. = 4.51 F. A. = ± 4°**

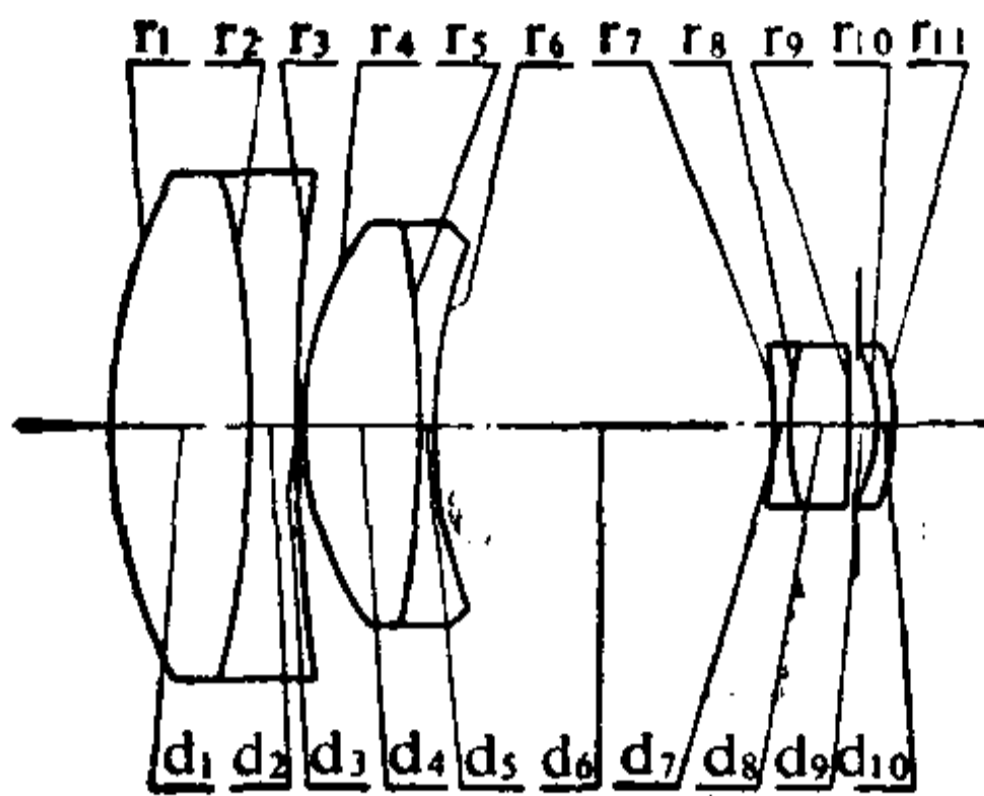

序号	r	d	n _d	v _d	序号	r	d	n _d	v _d
1	36.32	8.84	1.56384	60.76	7	-31.22	1.04	1.62041	60.29
2	-78.05	3.12	1.67270	32.23	8	21.08	3.64	1.56732	42.82
3	105.89	0.26			9	-77.46	2.00*		
4	22.56	7.54	1.57444	56.43	10	-10.39	0.97	1.56873	63.12
5	-78.05	1.04	1.58144	40.80	11	-15.79			
6	34.70	21.81							

2.00* = 1.00 + 1.00

	ΣS ₁	ΣS ₂	ΣS ₃	ΣS ₄	ΣS ₅	HI	QP(1ω)
	-0.0139	0.0113	-0.0122	0.0056	0.0280	7.0	1.5%
h 或 ω %	LA'	ΔH'	x _t	x _s	x _t - x _s	K _{T1}	K _{T0.7}
100	-0.263	0.108	-0.279	-0.089	-0.190	-0.7058	-0.1586
70	-0.214	0.042	-0.413	-0.096	-0.317	-0.1783	-0.0240

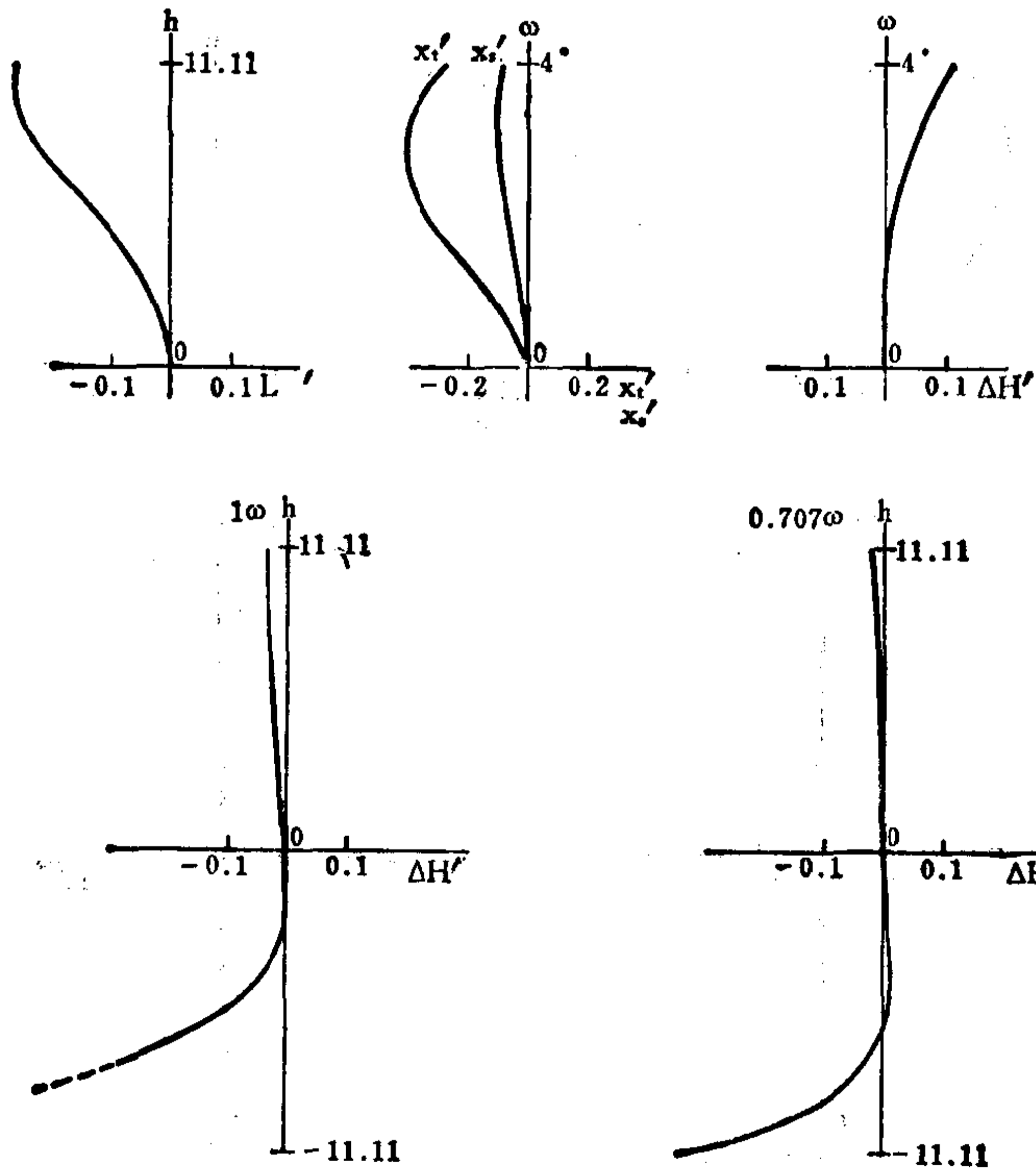

编号: 05-04-100

远 摄 物 镜

E. F. L = 96.56 B. F. L = 26.88 FNo. = 4.35 F. A. = ± 4°**

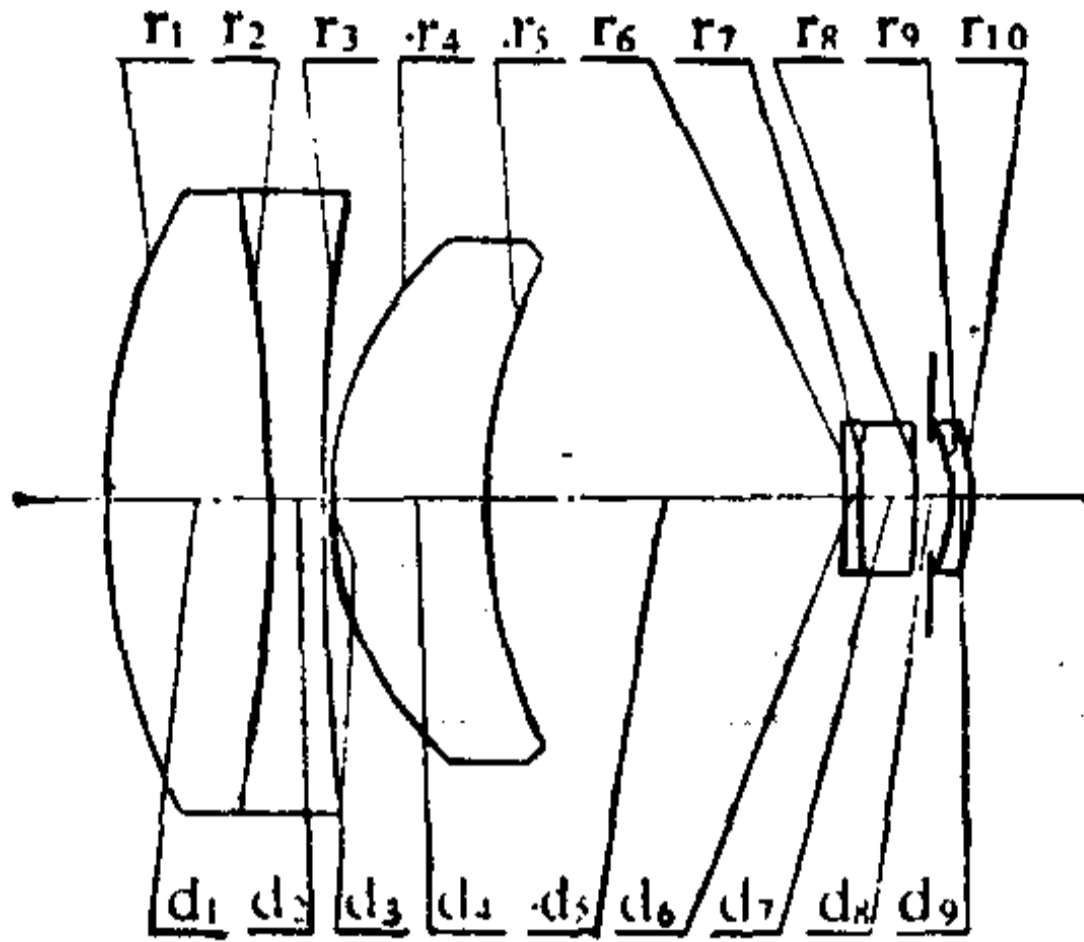

序号	r	d	n _d	v _d	序号	r	d	n _d	v _d
1	35.89	8.74	1.48749	70.04	6	-36.06	1.03	1.62041	60.29
2	-77.44	3.08	1.67270	32.23	7	30.85	2.70	1.56873	63.12
3	236.17	0.26			8	-77.14	1.96*		
4	19.09	8.48	1.48749	70.04	9	-9.60	0.96	1.56873	63.12
5	29.25	18.98			10	-14.18			

1.96* = 0.98 + 0.98

	ΣS ₁	ΣS ₂	ΣS ₃	ΣS ₄	ΣS ₅	HI	QP(1ω)
	-0.0175	0.0129	-0.0105	0.0038	0.0204	6.8	1.3%
h 或 ω%	LA'	ΔH'	x _t	x _s '	x _t ' - x _s '	K _{T1}	K _{T0.7}
100	-0.196	0.086	-0.777	-0.207	-0.570	-0.2280	-0.0079
70	-0.230	0.031	-0.464	-0.117	-0.347	-0.0544	0.0207

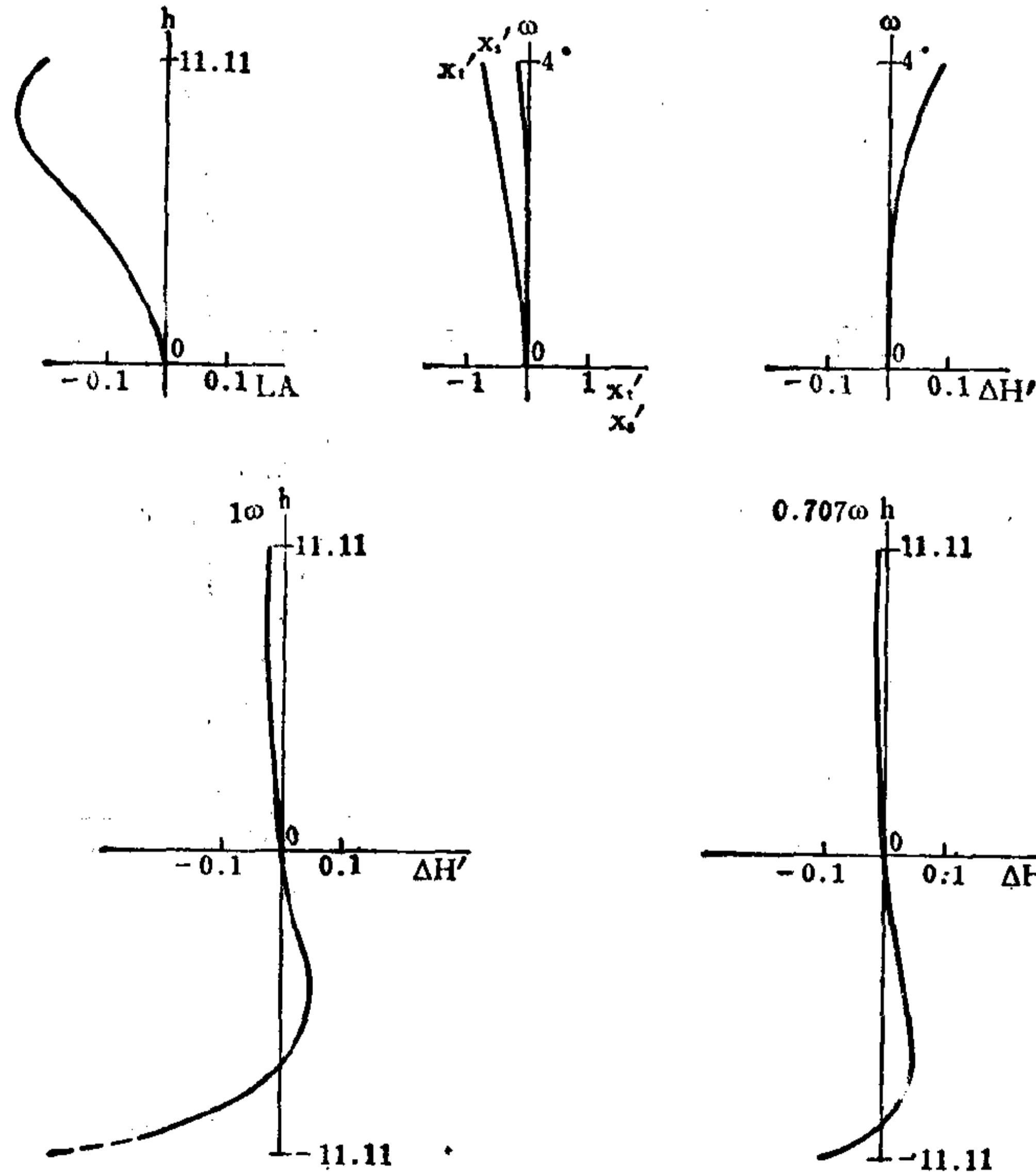

编号: 05-04-101

高斯型对称物镜

E. F. L = 112.48 B. F. L = 75.98 FNo. = 6.33 F. A. = $\pm 20'^{**}$

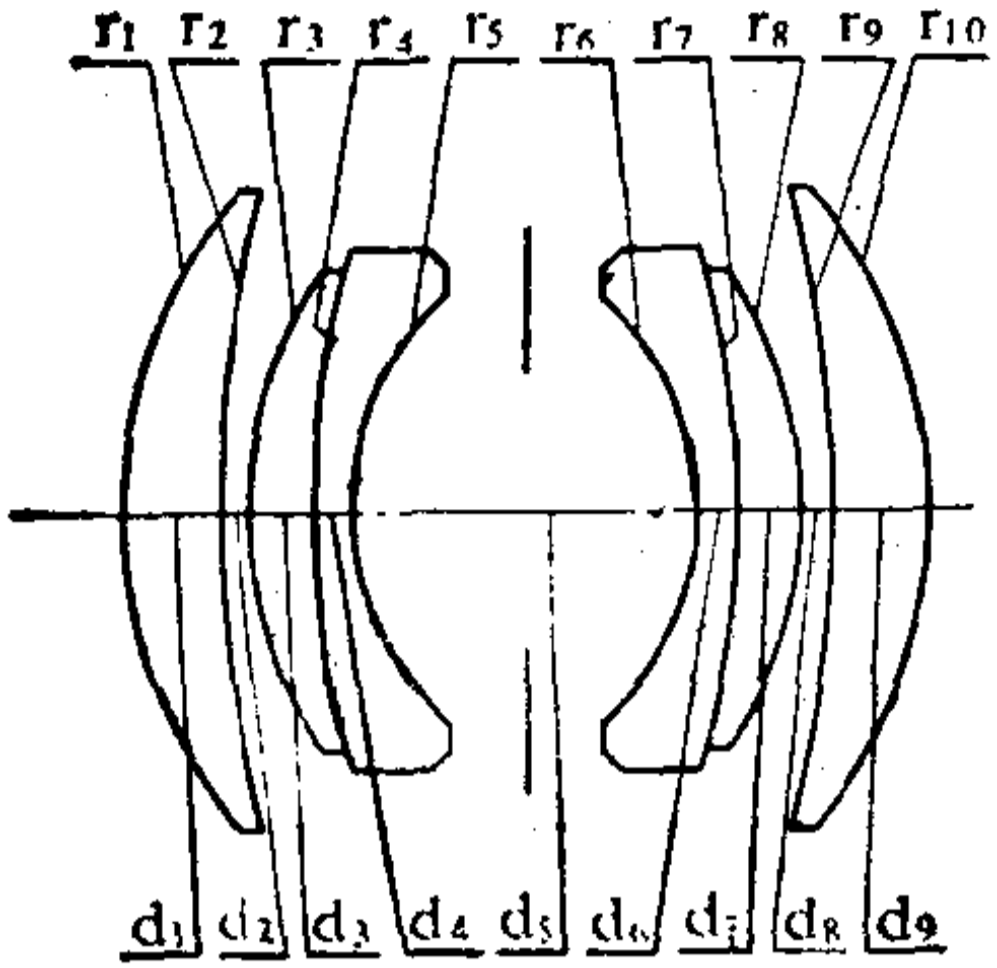

序号	r	d	n_D	v_D	序号	r	d	n_D	v_D
1	35.645	6.75	1.620	60.3	6	-20.800	2.75	1.596	39.7
2	89.536	2.20			7	-66.681	4.56	1.620	60.3
3	31.333	4.56	1.620	60.3	8	-31.333	2.20		
4	66.681	2.75	1.596	39.7	9	-89.536	6.75	1.620	60.3
5	20.800	24.56*			10	-35.645			

$24.56^* = 12.28 + 12.28$

	ΣS_1	ΣS_2	ΣS_3	ΣS_4	ΣS_5	HI	QP(1 ω)
	- 0.00199	- 0.00784	- 0.00632	- 0.01083	0.09047	41.1	1.7%
h 或 ω %	LA'	$\Delta H'$	x_t'	x_s'	$x_t' - x_s'$	K_{T1}	$K_{T0.7}$
100	- 0.0817	0.698	- 3.011	- 1.324	- 1.687	- 0.1436	- 0.0701
70	- 0.0610	0.227	- 1.440	- 0.714	- 0.726	- 0.1110	- 0.0535

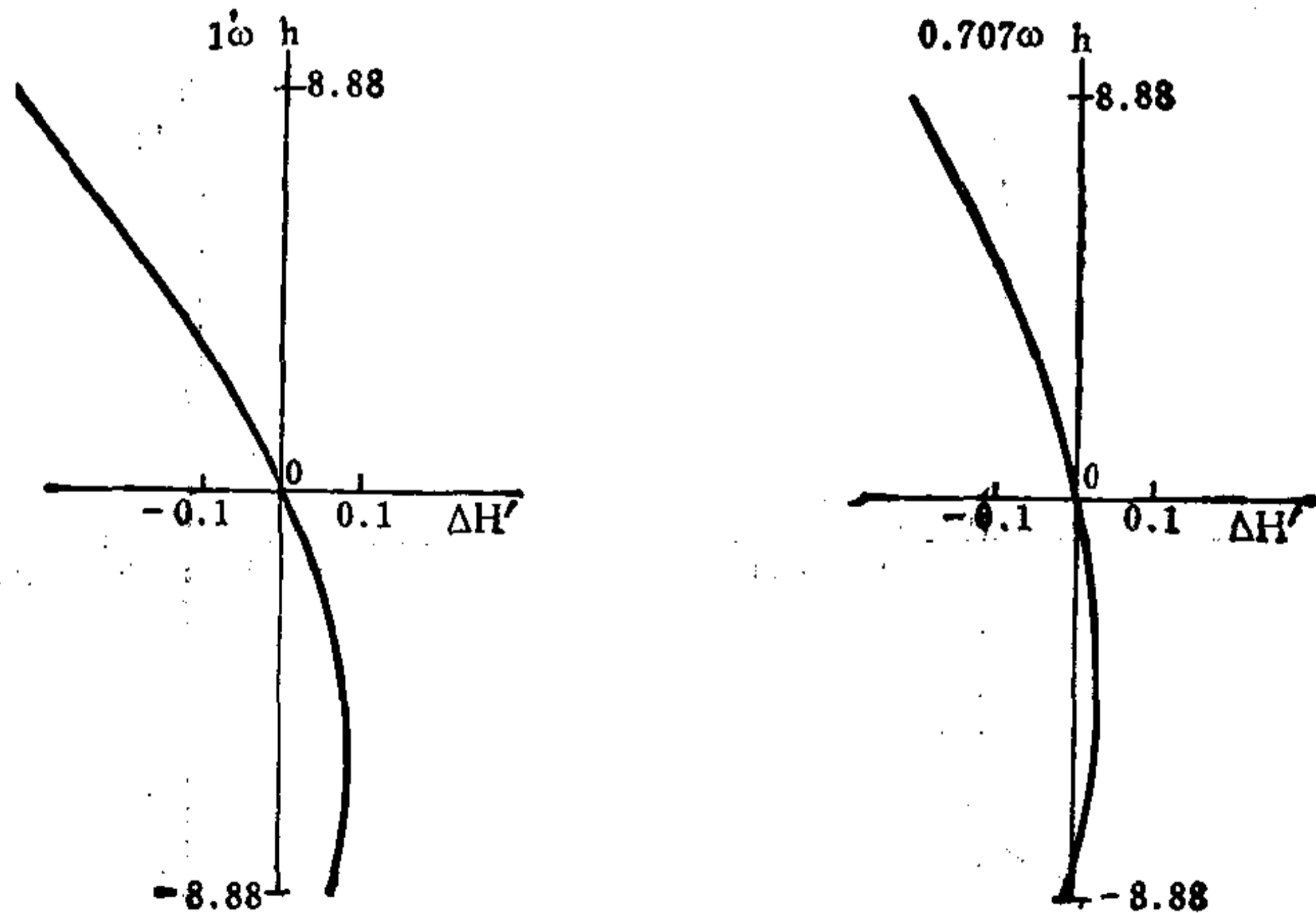
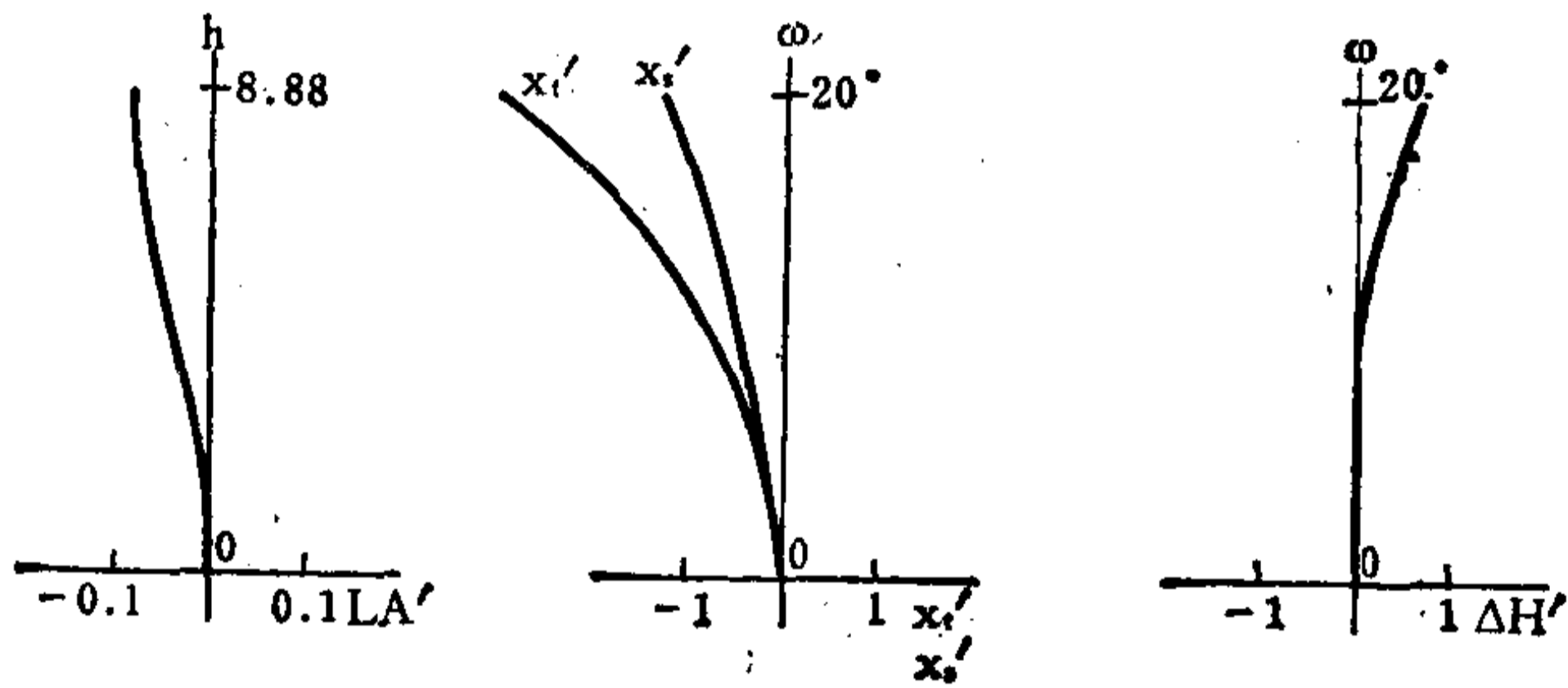

编号: 05-04-102

光学物镜

E.F.L.=1.0 B.F.L.=0.8089 FNo.=4.5 F.A.=±15°**

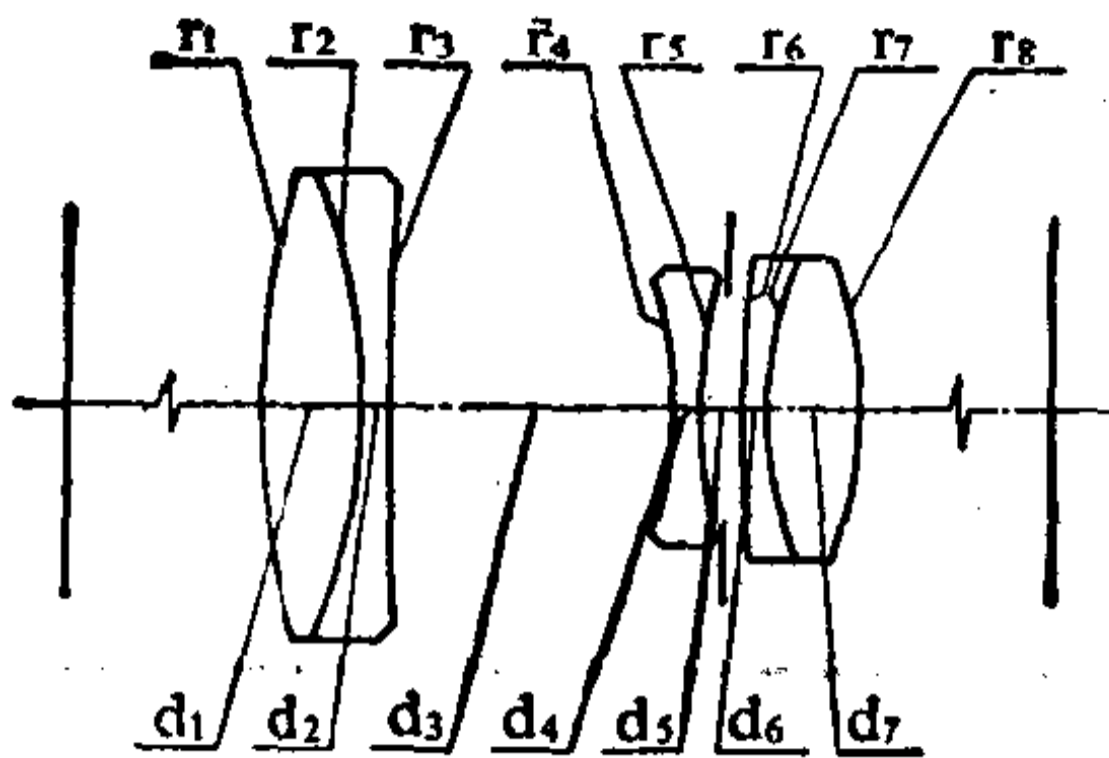

序号	r	d	n _d	v	序号	r	d	n _d	v
1	0.53758	0.06182	1.62041	60.29	5	0.35283	0.02487*		
2	-0.41462	0.02021	1.56138	45.27	6	1.29748	0.01494	1.51742	52.16
3	6.11841	0.18125			7	0.24949	0.08349	1.62041	60.29
4	-0.25703	0.02074	1.53172	48.87	8	-0.28523			

0.02487* = 0.01200 + 0.01287

	ΣS ₁	ΣS ₂	ΣS ₃	ΣS ₄	ΣS ₅	HI	QP(1ω)
	-0.00011	-0.00006	-0.00013	-0.00012	0.00094	0.27	2.1%
h 或 ω%	LA'	ΔH'	x' _i	x' _s	x' _i - x' _s	K _{T1}	K _{T0.7}
100	-0.00196	0.00568	-0.0442	-0.0112	-0.0330	0.00222	0.00052
70	-0.00168	0.00172	-0.0151	-0.0054	-0.0097	-0.00066	-0.00029

注: 1. M=1*~6*;
2. 以上象差值是按 l = -∞ 计算的。

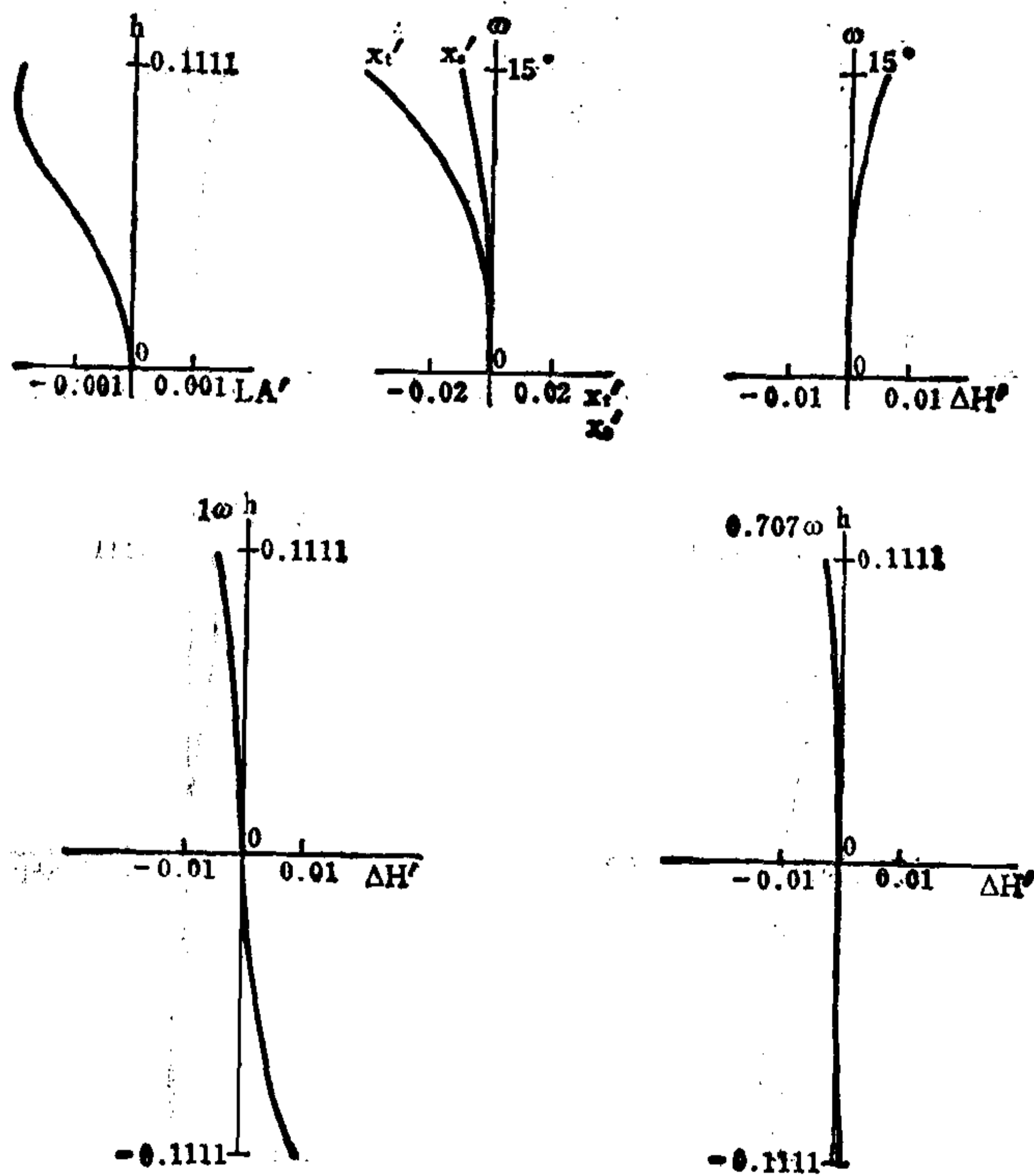

编号: 05-04-103

摄影放大机物镜

E.F.L=1.0 B.F.L=0.8264 FNo.=4.5 F.A.=±15°**

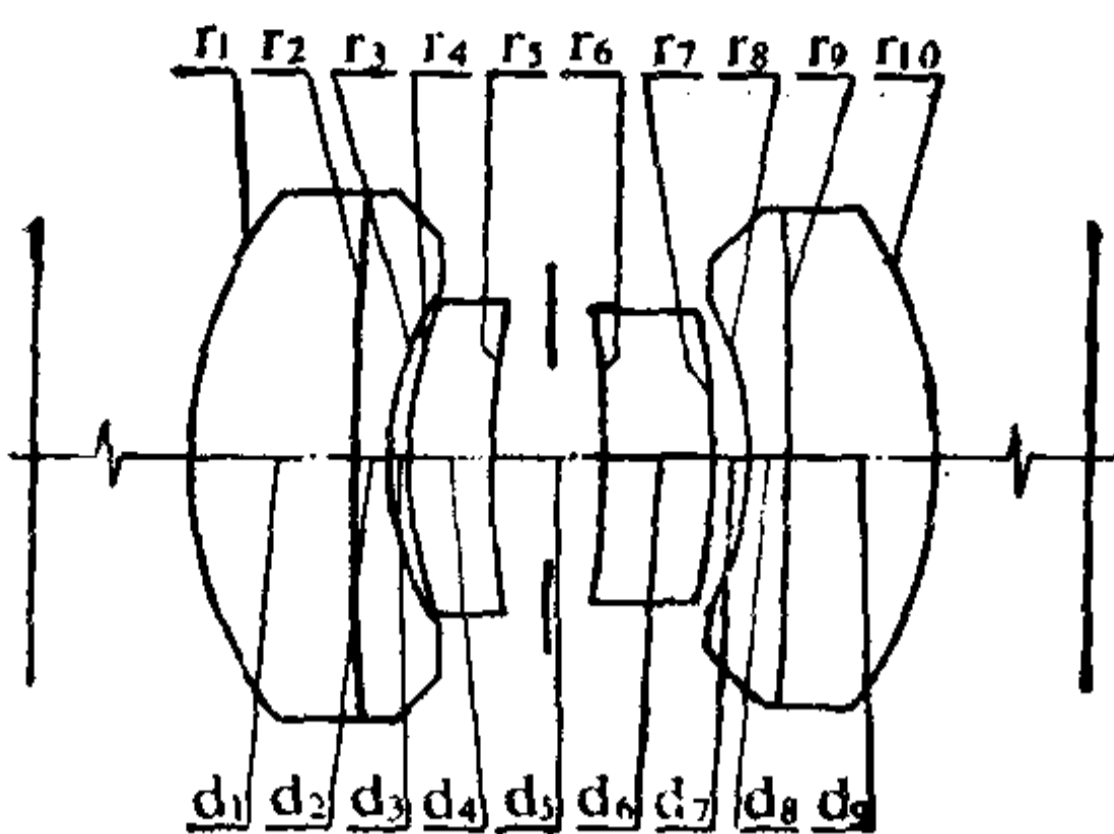

序号	r	d	n _d	v	序号	r	d	n _d	v
1	0.28255	0.09522	1.69100	54.80	6	-0.54639	0.05415	1.52310	50.93
2	10.30451	0.02683	1.62374	47.04	7	-0.26442	0.01259		
3	0.20152	0.02087			8	-0.19634	0.02368	1.64769	33.88
4	0.40912	0.06972	1.55361	51.36	9	-10.30451	0.10648	1.71700	47.90
5	0.81423	0.07187*			10	-0.27214			

0.071870* = 0.035935 + 0.035935

	ΣS ₁	ΣS ₂	ΣS ₃	ΣS ₄	ΣS ₅	HI	QP(1ω)
	-0.000235	-0.000017	0.000005	-0.000142	-0.000127	0.27	-0.22%
h 或 ω %	LA'	ΔH'	x' _t	x' _s	x' _t - x' _s	K' _{F1}	K' _{F0.7}
100	-0.00327	-0.00059	-0.00445	-0.00473	0.00028	-0.000174	-0.000146
70	-0.00339	-0.00021	-0.00243	-0.00260	0.00017	-0.000122	-0.000071

注: 1. M = 2~12*;
2. 以上象差值是按 l = -∞ 计算的。

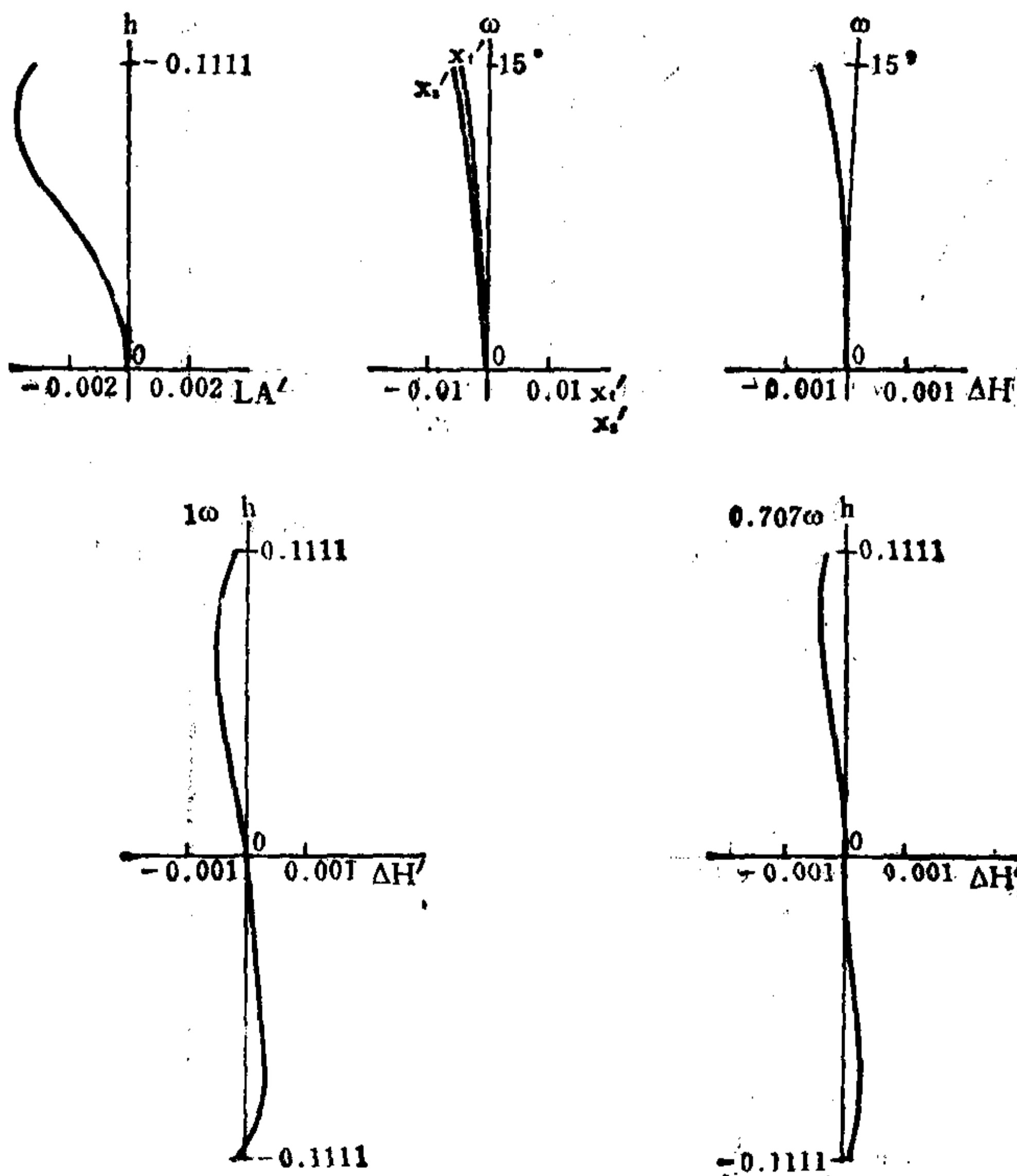

编号: 05-04-104

摄影放大机物镜

E.F.L=1.0 B.F.L=0.8292 FNo.=4.5 F.A.=±15°**

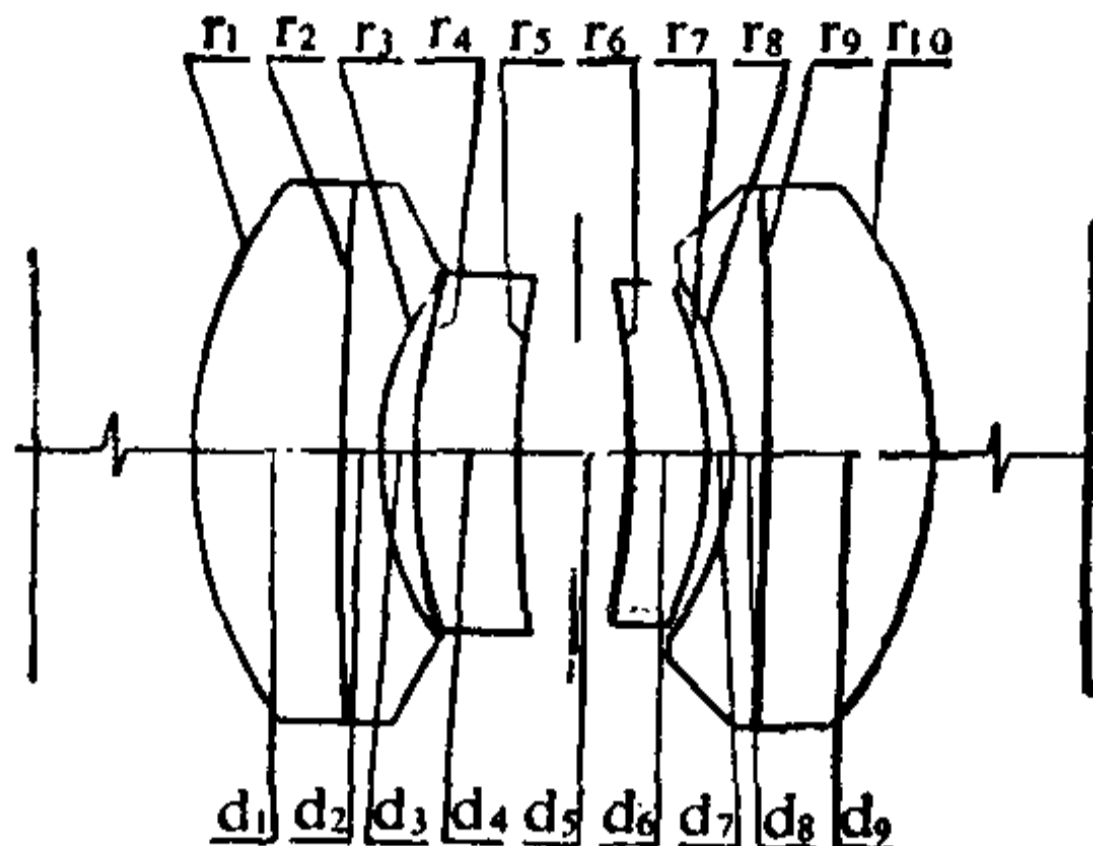

序号	r	d	n_d	v	序号	r	d	n_d	v
1	0.28349	0.09554	1.69100	54.80	6	-0.55670	0.05018	1.53172	48.87
2	20.62918	0.02692	1.62374	47.04	7	-0.26973	0.01263		
3	0.20219	0.02094			8	-0.19699	0.02376	1.64769	33.88
4	0.40920	0.06580	1.55115	49.61	9	-20.62918	0.10684	1.71700	47.90
5	0.81470	0.07078*			10	-0.27304			

$0.07078^* = 0.03539 + 0.03539$

	ΣS_1	ΣS_2	ΣS_3	ΣS_4	ΣS_5	HI	QP(1 ω)
	-0.000199	-0.000007	0.000004	-0.000139	-0.000128	0.26	-0.22%
h 或 ω %	LA'	$\Delta H'$	x'_i	x'_s	$x'_i - x'_s$	K'_{T1}	$K'_{T0.7}$
100	-0.00151	-0.00060	-0.00467	-0.00470	0.00003	-0.000142	-0.000077
70	-0.00259	-0.00021	-0.00248	-0.00258	0.00010	-0.000120	-0.000033

注: 1. $M = 2' \sim 12'$;
2. 以上象差值是按 $l = -\infty$ 计算的。

